



CONSUMER 2025
THE ANNIVERSARY EDITION

AULIX lighting

návrhy osvětlení a prodej svítidel
inteligentní systémy, vypínače

SVĚTELNÉ STUDIO

Náměstí Na Sádkách 705
252 41 Dolní Břežany (Praha západ)

Telefon: +420 246 083 152

Mobil.: +420 702 061 783

E-mail: studio@aulix.cz

Web: www.aulix.cz

E-shop: <http://obchod.aulix.cz>

Sledujte nás také na sociálních sítích:



1995-2025



CENTURY®

Per trent'anni, abbiamo acceso i sogni, illuminato le visioni e trasformato la luce in un simbolo di innovazione e qualità. Celebriamo con gratitudine questo trentesimo anniversario, consapevoli che il nostro successo è il frutto del lavoro di squadra e della fiducia dei nostri clienti.

La nostra passione per la luce ci spinge a cercare sempre nuove soluzioni, a reinventare il modo in cui illuminiamo il mondo. Ogni prodotto, ogni progetto è una testimonianza del nostro impegno verso l'eccellenza. Siamo pronti a affrontare il futuro con la stessa dedizione e creatività che ci hanno portato fin qui.

Ti invito a scoprire l'anima di CENTURY: un'azienda che mette al centro l'innovazione, la qualità e la sostenibilità. Lasciati ispirare dalle nostre idee, dai nostri prodotti e dalla nostra visione per un domani sempre più luminoso.

Grazie per essere parte di questo viaggio straordinario. Insieme, illumineremo il futuro.

For thirty years, we have created dreams, illuminated visions, and transformed light into a symbol of innovation and quality. We celebrate this thirtieth anniversary with gratitude, aware that our success is the result of teamwork and the trust of our customers.

Our passion for light drives us to constantly seek new solutions, to reinvent the way we illuminate the world. Every product, every project is an evidence to our commitment to excellence. We are ready to face the future with the same dedication and creativity that has led us to success.

I invite you to discover the soul of CENTURY: a company that places innovation, quality, and sustainability at its core. Let yourself be inspired by our ideas, our products, and our vision for an ever-brighter tomorrow.

Thank you for accompanying us on this extraordinary journey. Together, we will illuminate the future.

Claudio Loggia

CEO, CENTURY ITALIA S.R.L.



PHOTO INDEX

4

ABOUT US

8

Century Italia è fornitore a livello globale di soluzioni illuminotecniche. Progettando e innovando continuamente, ci impegniamo a portare il meglio in ogni casa, famiglia e organizzazione per un mondo sempre più efficiente e sostenibile.

Century Italia is global supplier of lighting solutions. By continually designing and innovating, we are committed to bringing the best to every home, family and organization for an increasingly efficient and sustainable world.



century-italia.com

SORGENTI							
	18	32	36	40	48		
GO SMART							
	57	58	60	61	62		
VERSATILI							
	66	67	68	70	72	73	
INDOOR							
	76	82	92	102	114		
OUTDOOR							
	118	128	134	144			
SOLARI							
	150	162	171	172	174	176	
WORK							
	182	184	186	187			
PROFESSIONAL							
	190	194	198	210	212	218	220
ESPOSITORI							
	228	230	230	230	231	231	231

SORGENTI



INCANTO WHITE
18



INCANTO +
20



INCANTO GOCCIA
22



INCANTO GLOBO
23



INCANTO CLEAR
24



INCANTO SATEN
25



INCANTO TUBOLARE
26



INCANTO SILVER
27



INCANTO CLEAR
DIMMABLE 28



INCANTO SATEN
DIMMABLE 29



INCANTO EPOCA
30



INCANTO EPOCA
31

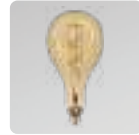

INCANTO EPOCA XL
31



HARMONY GLOBO
32



HARMONY GOCCIA
33



HARMONY
34



LEXAR
36



SPOT MULTILED
38

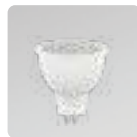

SPOT MAXILED
38



DICRO SHOP 95
39

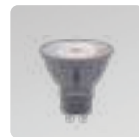

DICRO SHOP 90
39



PIXY G4
40



PIXY G9
41



PIXYFULL DIMM.
42



TRE-D
43



ARIA BT
44



DAY & NIGHT - MOTION SENSOR
45

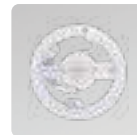

CIRCOLINA
46

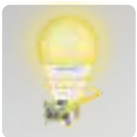

KILLER 50
47



VOTIVA
47



LAMPADA FRIGO
47

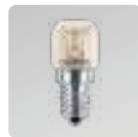

LAMPADA FORNO
47



MAXIMA
48



LOTUS
48



PLOSE STREET
49



PLOSE
49



SERIE LIGHT LR
50



SERIE LIGHT PAR
50



PAR 56
50

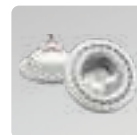

CITY LAMP
51



CITY LAMP GU10
51



SUPERLED
51



PL-COVER
51



GXLED
51

GO SMART



LAMPADRE SMART
57



ACCÈNTO SMART
58



CONTROLLER RGB+W
59



BLANCA SMART
60

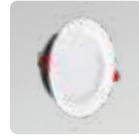

SPOTFIVE SMART
61



INTERRUTTORE SMART
62

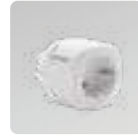

SMART POWER
63

VERSATILI



GIARDINETTO
66



MINI WORK
67



FUNNY
67

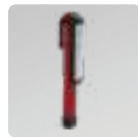

PENNY
67

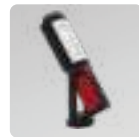

SALLY
67



STRISCIA LED SENSOR
68



STRISCIA LED USB
69



MOUSE
70



TOMMY
70



ITALO
70



NEMO
71



SOLIDEA
71



COMODA EMERG.
72



COMODA SOLAR
72



BORCHIA SOLARE
73



RIFLETTORE
73

INDOOR



BLANCA LUXE
76



BLANCA PERLA
78



BLANCA SLIM
79



PL-TONDO
80



PL-QUADRO
81



P-TONDO
82



P-QUADRO
83



SPOTFIVE
84



ELIO
86



FUTURA
87



KLAK
88

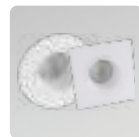

KLIK
90



JESSY APPLIQUE
92

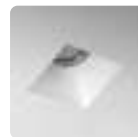

JESSY SQUARE
96



JESSY ROUND
100



ENFASI STYLO
102



ENFASI SQUARE
104



ENFASI ROUND
106



ESSENZA QUBE
108



ESSENZA RONDÒ
110



ESSENZA ORIENTABILE
112



FANTASY
114



FUSION 150
115

OUTDOOR



SIRIO SLIM
118



SIRIO BT
120



SMILE
122



PORTEO
124

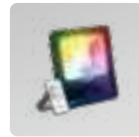

RAINBOW
126



OASI
128

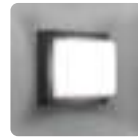

PURA
130



SIMPLY
132



UP&DOWN +
134



REVERSO
136



AXO
138



FORMA
140

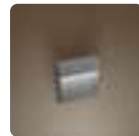

PASEO
142



BAMBOO
144

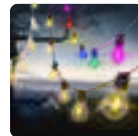

FIESTA
146



FIESTA 230 V
147

SOLARI



PROMETEO
150



ENERGY
152



GIRASOLE
154



GENIUS
156



DVERSO
158



SOLAR-B
160



UP&DOWN SOLAR
162



AURA
164



DOMINO
166



ARCADIA MAX
168



ARCADIA
170

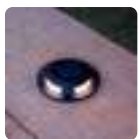

STEP SOLAR
171



BOLLA
172

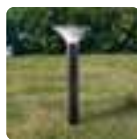

SUNNY
174



SUNNY XL
176



LEVANTE
178

WORK

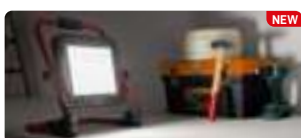

REWORK HYBRID
182



REWORK
184

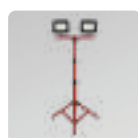

REWORK TREPPIEDI
185

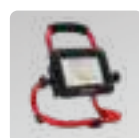

JOLLY
186



STAND
187



TRIPOD
187

PROFESSIONAL



BACKLIGHT
190



ADVANCE
191



DRIVER
192



INSTALLATION
193



BINARY
194



REGIA SHOP 180
195



CONNECTORS
196



ACCÈNTO PRO
198



ACCÈNTO PRO IP67
200



ACCÈNTO PRO RGB+W
201



MAGIC
202



ACCÈNTO RGB+W
203



ACCÈNTO 230 V
204



ACCÈNTO
206



DRIVER
208



CONNECTORS
208



CONTROLLER
209



INCASSO
210



CARTONGESSO
210



SUPERFICIE
211



SPEEDY
212



STABILA
213



SUPERLIGHT
214



PRIMA
215



SUPREMA ROUND
216



SUPREMA ROUND-V
217



FULL VISION +
218



FULL VISION
219



ATLAS
220



DISCOVERY MAX
224

ESPOSITORI



DOUBLE EXPO
228



MULTI SHOW
229



EXPO CEN
230

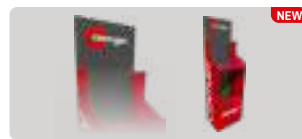

EXPO COMBO
230

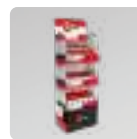

EXPO VASCH
230

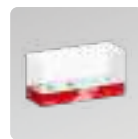

BALUX 5
230



BALUX 12
230



EXPO STRIP
230

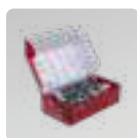

EXPO PR
230

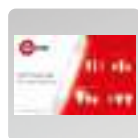

BANNER
231

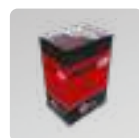

EXPO PROMO
231



CROWNIER
231

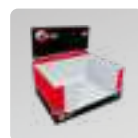

MAGIC BOX
231



DISPLAY GO SMART
231

DA 30 ANNI



TI ACCOMPAGNIAMO

1995 - 20



NELLA S



DELLA GIUSTA



25



LUCE

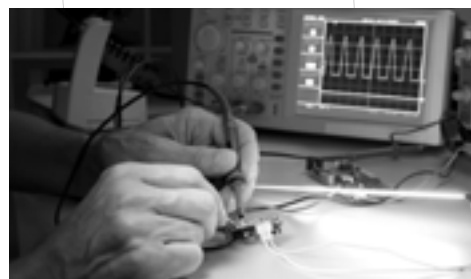

FOR **30 YEARS**
WE HAVE BEEN
ACCOMPANYING
YOU IN
CHOOSING THE
RIGHT **LIGHT**

CELTA



LA NOSTRA STORIA LA NOSTRA STORIA LA NOSTRA STORIA



1995



01.

Fondazione
Nel 1995 nasce Century, pronta ad illuminare i sogni delle persone.

Foundation
In 1995 Century was born, ready to illuminate people's dreams.

2004



02.

Simboli parlanti
Century crea i primi packaging con simboli parlanti. Nascono le confezioni con icone intuitive.

Talking Symbols
Century creates the first packaging with talking symbols. Packaging with intuitive icons is born.

2010



03.

Shuttle
Lancio sul mercato di Shuttle, il primo faretto LED sul mercato italiano.

Shuttle
Market launch of Shuttle, the first LED spotlight on the Italian market.

2011



04.

Lampade CFL
Century Italia vanta la gamma di lampade CFL più vasta d'Europa. Nel 2011, promuove per prima il concetto di Efficienza Luminosa, espressa in Lumen/Watt.

CFL lamps
Century Italia has the widest range of CFL lamps in Europe and is the first to promote luminous efficiency in Lumen/Watt.

2012



05.

Espansione all'estero
Century sbarca sul mercato austriaco. Successivamente è il turno di Rep. Ceca, Croazia, Francia, Irlanda, Malta, Germania e Portogallo.

Expansion abroad
Century lands on the Austrian market. Then it is the turn of the Czech Republic, Croatia, France, Ireland, Malta, Germany and Portugal.

2013



06.

Aria Plus
La migliore in termini di rapporto performance/prezzo: Aria Plus rompe il mercato.

Aria Plus
Best in class performance/price ratio: Aria Plus breaks the market

OUR HISTORY OUR HISTORY OUR HISTORY

08.

La nuova sede
Century apre una nuova sede a Latina su un'area di 32.000 m² con 8.000 m² di superficie coperta.

New headquarters
Century opens a new headquarters in Latina on an area of 32,000 m² with 8,000 m² of covered surface.



2016

2021



09.

Il Sole24ORE
Grande riconoscimento mediatico con l'articolo sul Sole24ORE

Sole24ORE
Great media recognition with the article on "Il Sole24ORE"

10.

Catalogo LED
10^a edizione del Catalogo LED.

LED Catalog
10th edition of the LED Catalog.



2022

2023

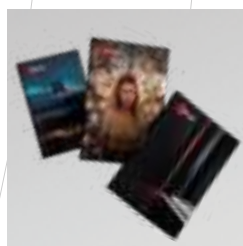

12.

I tre cataloghi
Innovativa progettazione di tre cataloghi distinti suddivisi per canali commerciali e tipologie di prodotto per agevolare il team di vendita.

Three catalogs
Innovative design of three distinct catalogs divided by commercial channels and product types to facilitate the sales team.

11.

Sostenibilità
Sensibilizzazione all'ecosostenibilità anche nelle confezioni: nascono i primi packaging 100% Plastic Free.

Sustainability
Raising awareness of eco-sustainability also for packaging: the first 100% Plastic Free packaging is born.



14.

30° anniversario
Century compie trent'anni.

30th Anniversary
Century turns thirty.

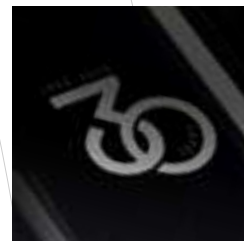

2025

2014



07.

KIT-FAMILY
Una geniale idea di marketing il KIT-FAMILY va a ruba.

KIT-FAMILY
A brilliant marketing idea: the KIT-FAMILY.



13.

Incanto White
Century è la prima sul mercato a presentare la lampada a filamento LED bianco: Incanto White.

Incanto White
Century is the first on the market to present the white LED filament lamp: Incanto White.

INSTALLAZIONI INSTALLAZIONI INSTALLAZIONI

01.
**Stazione Termini,
Roma**
Aree commerciali



02.
**Aeroporto "Leonardo da Vinci",
Fiumicino**
Aree commerciali



03.
**Castello Sforzesco,
Milano**
Rivellino di Santo Spirito



Presentiamo alcuni progetti di successo portati avanti nel corso degli anni, i quali raccontano l'esperienza e le realizzazioni più prestigiose di **CENTURY**.

Con **30 anni di storia** alle spalle, guardiamo al passato con orgoglio e soddisfazione. Questi traguardi sono il frutto del lavoro di un'azienda in continua **espansione**, guidata dalla **passione**, dall'**innovazione** e dalla **dedizione** del nostro team. Ogni progetto realizzato testimonia la nostra costante ricerca di **eccellenza** e il nostro **impegno** a illuminare il futuro con qualità e visione.

1995-2021

CENTURY

CASE HISTORY CASE HISTORY CASE HISTORY



04.
Quirinale,
Roma
Aree di servizio



05.
Mercato delle Vettovaglie,
Livorno
Area esterna



06.
Accademia della Moda,
Napoli
Area universitaria

We present some successful projects carried out over the years, which tell the story of the experience and the most prestigious achievements of **CENTURY**.

With **30 years** of history behind us, we look back with pride and satisfaction. These achievements are the result of the work of a company in continuous **expansion**, driven by the **passion, innovation** and **dedication** of our team. Each project carried out testifies to our constant search for **excellence** and our **commitment** to illuminate the future with quality and vision.

CHI SIAMO
CHI SIAMO
CHI SIAMO



I nostri valori
Our values

Impegno,
innovazione,
sostenibilità e
integrità.

Commitment, innovation,
sustainability and integrity.



01. Innovazione Innovation

Nata 30 anni fa dalla visione di un giovane imprenditore, Century Italia è oggi leader nel settore dell'illuminazione a LED. Con un'ampia gamma di oltre 2000 prodotti, illuminiamo con la stessa passione e innovazione del primo giorno.

Born 30 years ago from the vision of a young entrepreneur, Century Italia is now a leader in the LED lighting sector. With a wide range of over 2000 products, we illuminate with the same passion and innovation as the first day.

02. Lavoro di squadra Teamwork

Raccogliamo tutti i giorni i frutti del lavoro di un team affiatato, in cui l'entusiasmo e la professionalità si fondono in un ambiente giovane e dinamico. Crediamo fermamente che il teamwork sia la chiave per raggiungere risultati straordinari e la nostra squadra di esperti ne è la dimostrazione, costantemente impegnata nella ricerca e sviluppo di soluzioni illuminotecniche all'avanguardia.

Every day we reap the fruit of our labor thanks to a close-knit team, where enthusiasm and professionalism blend together in a young and dynamic environment. We firmly believe that teamwork is the key to achieving extraordinary results and our team of experts is proof of this, constantly committed to research and development of cutting-edge lighting solutions.



ABOUT US ABOUT US ABOUT US

I nostri punti di forza Our strengths

Alta qualità,
assistenza rapida
e professionale,
produzioni per
private labels,
consegna rapida.

High quality, fast and
professional assistance, private
label productions, fast delivery.



03. Integrità e sostenibilità Integrity and sustainability

Il nostro impegno ci ha permesso di realizzare oltre 200 progetti all'anno, collaborando con ingegneri, lighting designer e architetti di fama internazionale. Dalle lampadine domestiche ai prodotti per l'illuminazione industriale, offriamo soluzioni complete per ogni esigenza, sempre con un occhio attento alla qualità e al risparmio energetico. I nostri prodotti, rigorosamente testati e certificati, garantiscono la massima qualità e durata nel tempo.

Our commitment has allowed us to carry out over 200 projects a year, collaborating with internationally renowned engineers, lighting designers and architects. From domestic light bulbs to industrial lighting products, we offer complete solutions for every need, always with a careful eye on quality and energy saving. Our products, rigorously tested and certified, guarantee maximum quality and durability over time.



04. Esperienza Experience

Con una rete di vendita capillare in Italia e all'estero, siamo il partner ideale per chi cerca soluzioni illuminotecniche innovative e affidabili. In Century Italia, non seguiamo il mercato, lo creiamo, anticipando le tendenze e illuminando il futuro con la luce dell'esperienza, della passione e del lavoro di squadra.

With a widespread sales network in Italy and abroad, we are the ideal partner for those seeking innovative and reliable lighting solutions. At Century Italia, we do not follow the market, we create it, anticipating trends and illuminating the future with the light of experience, passion and teamwork.



HELP
WE
C

SOURCES
SOURCES
SOURCES



01



SORGENTI
SORGENTI
SORGENTI

SORGENTI

GO SMART

VERSATILI

INDOOR

OUTDOOR

SOLARI

WORK

PROFESSIONAL

ESPOSITORI

 **FILAMENTO**

INCANTO WHITE

INCANTO +

NEW INCANTO

INCANTO SILVER DOME

INCANTO DIMMERABILE

INCANTO EPOCA

 **CLASSICHE**

HARMONY

 **SPOT**

LEXAR

MULTILED

MAXILED

DICRO SHOP 95

DICRO SHOP 90

 **SPECIALI**

PIXY

PIXYFULL DIMMERABILE

NEW TRE-D

NEW ARIA BT

NEW SENSOR

CIRCOLINA

KILLER 50

VOTIVA

LAMPADA FRIGO

LAMPADA FORNO

 **PROFESSIONALI**

MAXIMA

LOTUS

PLOSE STREET

PLOSE

SERIE LIGHT

PAR56

CITY LAMP

SUPERLED

PL-COVER

GXLED



INCANTO WHITE



Innovativo LED a filamento bianco
Innovative white filament LED



Fino a 1.521 lm
Up to 1.521 lm



Luce calda 2700 K o naturale 4000 K
2700 K warm light or 4000 K natural

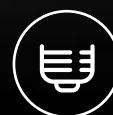

Attacco E14 o E27
E14 or E27 socket

L'innovativo filamento bianco si distingue dal tradizionale filamento giallo poiché si integra armoniosamente nell'arredamento grazie alla sua estetica total white.
The innovative white filament differs from the traditional yellow filament as it blends harmoniously into the ambience thanks to its total white look.

SORGENTI A FILAMENTO LED BIANCO
INCANTO WHITE

INVISIBLE FILAMENT



Ø 45 x 80 mm - 13 g



Ø 45 x 80 mm - 19 g



Ø 35 x 98 mm - 14 g



Ø 60 x 108 mm - 33 g



Ø 64 x 140 mm - 43 g



8-9 W - Ø 95 x 140 mm - 50 g
 13 W - Ø 125 x 172 mm - 102 g

Sfera E14	4 W = 40 W	470 lm	2700 K	INH1GW-451427	10/50	4,00 €
			4000 K	INH1GW-451440		

220-240 V IP20 330°

INVISIBLE FILAMENT

Sfera E27	4 W = 40 W	470 lm	2700 K	INH1GW-452727	10/50	4,00 €
			4000 K	INH1GW-452740		

220-240 V IP20 330°

INVISIBLE FILAMENT

Candela E14	4 W = 40 W	470 lm	2700 K	INM1W-451427	10/50	4,00 €
			4000 K	INM1W-451440		

220-240 V IP20 330°

INVISIBLE FILAMENT

Goccia E27	7 W = 60 W	806 lm	2700 K	ING3W-752727	10/50	5,00 €
			4000 K	ING3W-752740		
	8 W = 75 W	1.055 lm	2700 K	ING3W-092727	10/50	6,50 €
			4000 K	ING3W-092740		

220-240 V IP20 330°

INVISIBLE FILAMENT

Edison E27	7 W = 60 W	806 lm	2700 K	INPW-752727	10/50	6,20 €
			4000 K	INPW-752740		

220-240 V IP20 330°

INVISIBLE FILAMENT

Globo E27	9 W = 75 W	1.055 lm	2700 K	ING95W-092727	5/20	7,80 €
			4000 K	ING95W-092740		
	11,5 W = 100 W	1.521 lm	2700 K	ING125W-142727	5/20	11,20 €
			4000 K	ING125W-142740		

220-240 V IP20 330°

INVISIBLE FILAMENT

SORGENTI

GO SMART

VERSATILI

INDOOR

OUTDOOR

SOLARI

WORK

PROFESSIONAL

ESPOSITORI



50.000
hours

210
lm/W



La tecnologia LED del futuro è già qui.
The LED technology of the future is here.

GOCCIA A FILAMENTO LED
INCANTO +

SUPER EFFICIENT

210
lm/W

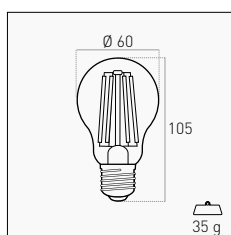

Goccia E27	2,2 W = 40 W	470 lm	3000 K	ING3A-022730	10/50	11,20 €
			4000 K	ING3A-022740		
	3,8 W = 60 W	806 lm	3000 K	ING3A-042730	10/50	13,70 €
			4000 K	ING3A-042740		
	5 W = 75 W	1.060 lm	3000 K	ING3A-052730	10/50	15,00 €
			4000 K	ING3A-052740		

220-240 V IP20 330°

210 50.000 h
lm/W

TECHNICAL NOTES

50% DI RISPARMIO ENERGETICO RISPETTO ALLE ALTRE LAMPADIE A FILAMENTO LED
50% ENERGY SAVING COMPARED TO OTHER FILAMENT LED LAMPS

Lampade a filamento LED in vetro trasparente, luminose e super efficienti.
Bright and super efficient transparent glass LED filament lamps.

SORGENTI A FILAMENTO LED

INCANTO



4/7/8/11 W - Ø 60 x 108 mm - 33 g
16 W - Ø 75 x 140 mm - 55 g

CLEAR

Goccia E27	4 W = 40 W	470 lm	2700 K	ING3-042727	10/50	3,60 €
			4000 K	ING3-042740		
	7 W = 60 W	806 lm	2700 K	ING3-082727	10/50	4,20 €
			4000 K	ING3-082740		
	8 W = 75 W	1.055 lm	2700 K	ING3P-082727	10/50	5,00 €
			4000 K	ING3P-082740		
	11 W = 100 W	1.521 lm	2700 K	ING3-122727	10/50	6,50 €
			4000 K	ING3-122740		
	16 W = 140 W	2.300 lm	2700 K	ING3-162727	10/50	13,50 €
			4000 K	ING3-162740		

11-16 W 220-240 V IP20 330°



4/7/8/11 W - Ø 60 x 108 mm - 33 g
16 W - Ø 75 x 140 mm - 55 g

SATEN

Goccia E27	4 W = 40 W	470 lm	3000 K	INSG3-042730	10/50	3,80 €
			4000 K	INSG3-042740		
			6500 K	INSG3-042760		
	7 W = 60 W	806 lm	3000 K	INSG3-082730	10/50	4,30 €
			4000 K	INSG3-082740		
			6500 K	INSG3-082760		
	8 W = 75 W	1.055 lm	3000 K	INSG3P-082730	10/50	5,00 €
			4000 K	INSG3P-082740		
			6500 K	INSG3P-082760		
	11 W = 100 W	1.521 lm	3000 K	INSG3-122730	10/50	6,70 €
			4000 K	INSG3-122740		
			6500 K	INSG3-122760		
16 W = 140 W	2.300 lm	3000 K	INSG3-162730	10/50	13,50 €	
		4000 K	INSG3-162740			
		6500 K	INSG3-162760			

11-16 W 220-240 V IP20 330°

Lampade a filamento LED in vetro trasparente o opale, per un'illuminazione morbida e diffusa.
LED filament lamps in transparent or opal glass, for soft and diffused lighting.

NEW

SORGENTI A FILAMENTO LED

INCANTO



8 W - Ø 95 x 140 mm - 50 g
 11 - 16 W - Ø 125 x 170 mm - 100 g
 22 W - Ø 125 x 170 mm - 95 g

CLEAR

Globo E27	8 W = 75 W	1.055 lm	2700 K	ING95-082727	5/20	8,50 €
			4000 K	ING95-082740		
	11 W = 100 W	1.521 lm	2700 K	ING125-122727	5/20	12,50 €
			4000 K	ING125-122740		
	16 W = 140 W	2.300 lm	2700 K	ING125-162727	5/20	17,00 €
			4000 K	ING125-162740		
	22 W = 200 W	3.452 lm	2700 K	ING125-222727 NEW	5/20	22,00 €
			4000 K	ING125-222740 NEW		



8 W - Ø 95 x 140 mm - 50 g
 11 - 16 W - Ø 125 x 170 mm - 100 g
 22 W - Ø 125 x 170 mm - 95 g

SATEN

Globo E27	8 W = 75 W	1.055 lm	3000 K	INSG95-082730	5/20	9,00 €
			4000 K	INSG95-082740		
			6500 K	INSG95-082760		
	11 W = 100 W	1.521 lm	3000 K	INSG125-122730	5/20	13,50 €
			4000 K	INSG125-122740		
			6500 K	INSG125-122760		
	16 W = 140 W	2.300 lm	3000 K	INSG125-162730	5/20	18,00 €
			4000 K	INSG125-162740		
			6500 K	INSG125-162760		
22 W = 200 W	3.100 lm	3000 K	INSG125-222730 NEW	5/20	23,00 €	
		4000 K	INSG125-222740 NEW			
		6500 K	INSG125-222760 NEW			

Lampade a filamento LED in vetro trasparente o opale, per un'illuminazione morbida e diffusa.
 LED filament lamps in transparent or opal glass, for soft and diffused lighting.

SORGENTI A FILAMENTO LED

INCANTO

CLEAR



Ø 45 x 80 mm - 13 g

Sfera E14	2 W = 25 W	250 lm	2700 K	INH1G-021427	10/50	2,90 €
			2700 K	INH1G-041427		
	4 W = 40 W	470 lm	4000 K	INH1G-041440	10/50	3,40 €
			2700 K	INH1G-061427		
	6 W = 60 W	806 lm	4000 K	INH1G-061440	10/50	4,20 €
			2700 K	INH1G-061427		

E 220-240 V IP20 330°



Ø45 x 80 mm - 19 g

Sfera E27	2 W = 25 W	250 lm	2700 K	INH1G-022727	10/50	2,90 €
			2700 K	INH1G-042727		
	4 W = 40 W	470 lm	4000 K	INH1G-042740	10/50	3,40 €
			2700 K	INH1G-062727		
	6 W = 60 W	806 lm	4000 K	INH1G-062740	10/50	4,20 €
			2700 K	INH1G-062727		

E 220-240 V IP20 330°



Ø35 x 98 mm - 13 g

Candela E14	2 W = 25 W	250 lm	2700 K	INM1-021427	10/50	2,90 €
			2700 K	INM1-041427		
	4 W = 40 W	470 lm	4000 K	INM1-041440	10/50	3,40 €
			2700 K	INM1-061427		
	6 W = 60 W	806 lm	4000 K	INM1-061440	10/50	4,20 €
			2700 K	INM1-061427		

E 220-240 V IP20 330°



Ø35 x 98 mm - 13 g

Tortiglione E14	4 W = 40 W	470 lm	2700 K	INTOR-041427	10/50	3,40 €
			4000 K	INTOR-041440		
	6 W = 60 W	806 lm	2700 K	INTOR-061427	10/50	4,20 €
			4000 K	INTOR-061440		

E 220-240 V IP20 330°



Ø35 x 118 mm - 13 g

Colpo di Vento E14	2 W = 25 W	250 lm	2700 K	INM1C-021427	10/50	2,90 €
			2700 K	INM1C-041427		
	4 W = 40 W	470 lm	4000 K	INM1C-041440	10/50	3,40 €
			2700 K	INM1C-061427		

E 220-240 V IP20 330°

Lampade a filamento LED in vetro trasparente, per un'illuminazione diffusa a 330°.
 Transparent glass LED filament lamps with 330° diffused lighting.

SORGENTI A FILAMENTO LED

INCANTO

SATEN



Ø 45 x 80 mm - 13 g



Ø45 x 80 mm - 19 g



Ø35 x 98 mm - 13 g



Ø35 x 98 mm - 13 g



Ø35 x 118 mm - 13 g

Sfera E14	4 W = 40 W	470 lm	3000 K	INSH1G-041430	10/50	3,40 €
			4000 K	INSH1G-041440		
			6500 K	INSH1G-041460		
	6 W = 60 W	806 lm	3000 K	INSH1G-061430	10/50	4,30 €
			4000 K	INSH1G-061440		
			6500 K	INSH1G-061460		

220-240 V IP20 330°

Sfera E27	4 W = 40 W	470 lm	3000 K	INSH1G-042730	10/50	3,40 €
			4000 K	INSH1G-042740		
			6500 K	INSH1G-042760		
	6 W = 60 W	806 lm	3000 K	INSH1G-062730	10/50	4,30 €
			4000 K	INSH1G-062740		
			6500 K	INSH1G-062760		

220-240 V IP20 330°

Candela E14	4 W = 40 W	470 lm	3000 K	INSM1-041430	10/50	3,40 €
			4000 K	INSM1-041440		
			6500 K	INSM1-041460		
	6 W = 60 W	806 lm	3000 K	INSM1-061430	10/50	4,30 €
			4000 K	INSM1-061440		
			6500 K	INSM1-061460		

220-240 V IP20 330°

Tortiglione E14	4 W = 40 W	470 lm	3000 K	INSTOR-041430	10/50	3,40 €
			4000 K	INSTOR-041440		
			6500 K	INSTOR-041460		
	6 W = 60 W	806 lm	3000 K	INSTOR-061430	10/50	4,30 €
			4000 K	INSTOR-061440		
			6500 K	INSTOR-061460		

220-240 V IP20 330°

Colpo di Vento E14	4 W = 40 W	470 lm	3000 K	INSM1C-041430	10/50	3,40 €
			4000 K	INSM1C-041440		
			6500 K	INSM1C-041460		

220-240 V IP20 330°

Lampade a filamento LED in vetro opale, per un'illuminazione morbida e diffusa.
Opal glass LED filament lamps with soft and diffused lighting.

SORGENTI A FILAMENTO LED

INCANTO

TUBOLARE



4 W - Ø 25 x 85 mm - 12 g
7 W - Ø 30 x 102 mm - 17 g

CLEAR E14

E14	4 W = 40 W	470 lm	2700 K	INTB-041427	10/50	3,70 €
			4000 K	INTB-041440		
	7 W = 75 W	1.110 lm	2700 K	INTB-071427	10/50	5,50 €
			4000 K	INTB-071440		

220-240 V IP20 330°
7W



Ø 30 x 98 mm - 23 g

CLEAR E27

E27	9 W = 85 W	1.200 lm	2700 K	INTB-092727	10/50	7,50 €
			4000 K	INTB-092740		

220-240 V IP20 330°



Ø 30 x 102 mm - 17 g

SATEN E14

E14	7 W = 75 W	1.110 lm	3000 K	INSTB-071430	10/50	5,50 €
			4000 K	INSTB-071440		
			6500 K	INSTB-071460		

220-240 V IP20 330°



Ø 30 x 98 mm - 23 g

SATEN E27

E27	9 W = 85 W	1.200 lm	3000 K	INSTB-092730	10/50	7,50 €
			4000 K	INSTB-092740		
			6500 K	INSTB-092760		

220-240 V IP20 330°

Lampade tubolari con innovativa tecnologia a filamento LED in vetro opale o trasparente.
Tubular lamps with innovative LED filament technology in opal or transparent glass..

SORGENTI A FILAMENTO LED
INCANTO SILVER DOME

CLEAR - DIMMABLE



Ø 60 x 108 mm - 33 g

GOCCIA SILVER DOME

E27	8 W = 60 W	900 lm	Dimm.	2700 K	ING3SD-082727	10/50	7,90 €
	11 W = 100 W	1.350 lm	No Dimm.	2700 K	ING3S-112727	10/50	9,80 €

220-240 V IP20 330°

ANTI-GLARE SILVER DOME DIMMABLE (8W)



Ø45 x 80 mm - 15 g

SFERA SILVER DOME

E14	6 W = 60 W	680 lm	Dimm.	2700 K	INH1GSD-061427	10/50	7,50 €
-----	------------	--------	-------	--------	-----------------------	-------	--------

220-240 V IP20 330°

ANTI-GLARE SILVER DOME DIMMABLE

TECHNICAL NOTES

DIMMERABILI CON SISTEMI A TAGLIO DI FASE
 DIMMABLE WITH TRAILING-EDGE SYSTEMS



Versione E27
E27 Version



Versione E14
E14 Version



Cupola argentata
Silver dome



NO abbagliamento
NO glare



NO dispersione
NO dispersion



Dimmerabile
Dimmable

Lampade a filamento LED in vetro trasparente con cupola argentata effetto specchio per una diffusione mirata della luce.
 Clear glass LED filament lamps with mirror effect silver dome for focused light diffusion.

SORGENTI A FILAMENTO LED

INCANTO



CLEAR - DIMMABLE



Ø 60 x 108 mm - 33 g

Goccia E27	11 W = 100 W	1.521 lm	2700 K	INDG3-112727	10/50	10,00 €
			4000 K	INDG3-112740		

220-240 V IP20 330°

DIMMABLE



Ø45 x 80 mm - 15 g

Sfera E14	6 W = 60 W	806 lm	2700 K	INDH1G-061427	10/50	5,80 €
			4000 K	INDH1G-061440		

220-240 V IP20 330°

DIMMABLE



Ø35 x 98 mm - 13 g

Candela E14	6 W = 60 W	806 lm	2700 K	INDM1-061427	10/50	5,80 €
			4000 K	INDM1-061440		

220-240 V IP20 330°

DIMMABLE

TECHNICAL NOTES



DIMMERABILI CON SISTEMI A TAGLIO DI FASE
DIMMABLE WITH TRAILING-EDGE SYSTEMS

Lampade a filamento LED dimmerabili in vetro trasparente, per un'illuminazione diffusa a 330°.
Dimmable transparent glass LED filament lamps with 330° diffused lighting.

SORGENTI A FILAMENTO LED

INCANTO

SATEN - DIMMABLE



Ø 60 x 108 mm - 33 g

Goccia E27	11 W = 100 W	1.521 lm	3000 K	INSDG3-112730	10/50	11,00 €
			4000 K	INSDG3-112740		

220-240 V IP20 330°



Ø45 x 80 mm - 15 g

Sfera E14	6 W = 60 W	806 lm	3000 K	INSDH1G-061430	10/50	6,70 €
			4000 K	INSDH1G-061440		

220-240 V IP20 330°



Ø35 x 98 mm - 13 g

Candela E14	6 W = 60 W	806 lm	3000 K	INSDM1-061430	10/50	6,70 €
			4000 K	INSDM1-061440		

220-240 V IP20 330°



TECHNICAL NOTES



DIMMERABILI CON SISTEMI A TAGLIO DI FASE
DIMMABLE WITH TRAILING-EDGE SYSTEMS

Lampade a filamento LED dimmerabili in vetro opale, per un'illuminazione morbida e diffusa.
Dimmable opal glass LED filament lamps with soft and diffused lighting.

SORGENTI A FILAMENTO LED
INCANTO EPOCA



AMBER - DIMMABLE



Ø 35 x 98 mm - 14 g

CANDELA

E14	4 W = 30 W	400 lm	No Dimm.	2200 K	INVM1-041422	10/50	5,50 €
			Dimm.	2200 K	INVM1D-041422	10/50	6,70 €

220-240 V IP20 330°

AMBER FINISH INVM1D DIMMABLE

TECHNICAL NOTES

DIMMERABILE CON SISTEMI A TAGLIO DI FASE
 DIMMABLE WITH TRAILING-EDGE SYSTEMS



Ø 35 x 98 mm - 14 g

TORTIGLIONE

E14	4 W = 30 W	400 lm	No Dimm.	2200 K	INVTOR-041422	10/50	5,50 €
-----	------------	--------	----------	--------	----------------------	-------	--------

220-240 V IP20 330°

AMBER FINISH



Ø 37 x 118 mm - 14 g

COLPO DI VENTO

E14	4 W = 30 W	400 lm	No Dimm.	2200 K	INVM1C-041422	10/50	5,50 €
-----	------------	--------	----------	--------	----------------------	-------	--------

220-240 V IP20 330°

AMBER FINISH



Ø 60 x 106 mm - 33 g

GOCCIA

E27	8 W = 60 W	806 lm	No Dimm.	2200 K	INVG3-082722	10/50	6,70 €
-----	------------	--------	----------	--------	---------------------	-------	--------

220-240 V IP20 330°

AMBER FINISH

Lampade a filamento LED dalla finitura ambrata che garantiscono un'atmosfera suggestiva.
 Amber finish LED filament lamps for a suggestive atmosphere.

SORGENTI A FILAMENTO LED
INCANTO EPOCA

AMBER - DIMMABLE



Ø 64 x 140 mm - 40 g

EDISON

E27	8 W = 60 W	806 lm	No Dimm.	2200 K	INVP-082722	10/50	7,50 €
	11 W = 85 W	1.350	Dimm.	2200 K	INVPD-122722	10/50	11,00 €

11 W 220-240 V IP20 330°

AMBER FINISH DIMMABLE (11 W)



Ø 125 x 170 mm - 100 g

GLOBO

E27	8 W = 60 W	806 lm	No Dimm.	2200 K	INVG125-082722	5/20	17,00 €
	11 W = 85 W	1.350	Dimm.	2200 K	INVG125D-122722	5/20	19,90 €

11 W 220-240 V IP20 330°

AMBER FINISH DIMMABLE (11 W)



Ø 160 x 320 mm - 265 g

GLOBO XL

E27	8 W = 60 W	806 lm	Dimm.	2200K	INVPS160-082722	1/4	77,00 €
-----	------------	--------	-------	-------	------------------------	-----	---------

220-240 V IP20 330°

AMBER FINISH DIMMABLE

XL



Ø 200 x 300 mm - 366 g

GLOBO XL

E27	8 W = 60 W	806 lm	Dimm.	2200K	INVG200-082722	1/4	79,00 €
-----	------------	--------	-------	-------	-----------------------	-----	---------

220-240 V IP20 330°

AMBER FINISH DIMMABLE

TECHNICAL NOTES



DIMMERABILI CON SISTEMI A TAGLIO DI FASE
DIMMABLE WITH TRAILING-EDGE SYSTEMS

Lampade a filamento LED dalla finitura ambrata che garantiscono un'atmosfera suggestiva.
Amber finish LED filament lamps for a suggestive atmosphere.

SORGENTI CLASSICHE
HARMONY



GLOBO - DIMMABLE



	A mm	B mm	g
15 W	Ø 95	143	78
20 W	Ø 120	163	143
24 W	Ø 120	158	173
24 W Dimm	Ø 125	173	150

*DISPONIBILE ANCHE SINGOLARMENTE
SINGLE UNITS AVAILABLE

Globo E27	15 W = 90 W	1.500 lm	No Dimm.	3000 K	HR80G95-152730	6/24	9,50 €
				4000 K	HR80G95-152740		
				6500 K	HR80G95-152760		
Globo E27	20 W = 120 W	2.100 lm	No Dimm.	3000 K	HR80G120-202730	6/24	12,50 €
				4000 K	HR80G120-202740		
				6500 K	HR80G120-202760		
Globo E27	24 W = 130 W	2.500 lm	No Dimm.	3000 K	HR80G120-242730	6/24	14,50 €
				4000 K	HR80G120-242740		
				6500 K	HR80G120-242760		
			Dimm.	3000 K	HRDG125-242730	6/24	17,00 €
				4000 K	HRDG125-242740		
				6500 K	HRDG125-242760		

220-240 V IP20 220°

DIMMABLE (HRDG125)

TECHNICAL NOTES

 DIMMERABILE CON SISTEMI A TAGLIO DI FASE
DIMMABLE WITH TRAILING-EDGE SYSTEMS

Massima qualità della luce e possibilità di scelta tra diverse temperature di colore luce.
Maximum light quality and choice between different light color temperatures.

SORGENTI CLASSICHE
HARMONY



GOCCIA - DIMMABLE



	A mm	B mm	g
9 W	∅ 60	108	30
11 W	∅ 60	108	30
15 W	∅ 60	123	40
18 W	∅ 65	120	90
20 W	∅ 65	133	65

Goccia E27	9 W = 60 W	820 lm	No Dimm.	3000 K	HR80G3-092730	10/50	2,50 €
				4000 K	HR80G3-092740		
				6500 K	HR80G3-092764		
	11 W = 75 W	1.055 lm	No Dimm.	3000 K	HR80G3-112730	10/50	3,00 €
				4000 K	HR80G3-112740		
				6500 K	HR80G3-112764		
	15 W = 100 W	1.521 lm	No Dimm.	3000 K	HR80G3-152730	10/50	4,50 €
				4000 K	HR80G3-152740		
				6500 K	HR80G3-152764		
	18 W = 100 W	1.921 lm	No Dimm.	3000 K	HR80G3-172730	10/50	5,50 €
				4000 K	HR80G3-172740		
				6500 K	HR80G3-172764		
	20 W = 150 W	2.450 lm	No Dimm.	3000 K	HR80G3-202730	10/50	8,50 €
				4000 K	HR80G3-202740		
				6500 K	HR80G3-202765		
Dimm.			3000 K	HR80G3D-202730	10/50	12,00 €	
			4000 K	HR80G3D-202740			
			6500 K	HR80G3D-202765			

20 W 220-240 V IP20 200° 180°
18-20 W

DIMMABLE (HR80G3D) 3 YEARS (20 W)

TECHNICAL NOTES

DIMMERABILE CON SISTEMI A TAGLIO DI FASE
DIMMABLE WITH TRAILING-EDGE SYSTEMS

Massima qualità della luce e possibilità di scelta tra diverse temperature di colore luce.
Maximum light quality and choice between different light color temperatures.

SORGENTI CLASSICHE
HARMONY

SFERA



4 W - 6 W - Ø 45 x 80 mm - 23 g
 8 W - Ø 45 x 80 mm - 33 g

E14	4 W = 30 W	350 lm	200°	3000 K	HR80H1G-041430	10/50	2,00 €
				4000 K	HR80H1G-041440		
				6500 K	HR80H1G-041464		
	6 W = 40 W	490 lm	200°	3000 K	HR80H1G-061430	10/50	2,40 €
				4000 K	HR80H1G-061440		
				6500 K	HR80H1G-061465		
	8 W = 60 W	806 lm	180°	3000 K	HR80H1G-081430	10/50	3,10 €
				4000 K	HR80H1G-081440		
				6500 K	HR80H1G-081465		

220-240 V
 IP20
 6 W

SFERA



4 W - 6 W - Ø 45 x 80 mm - 23 g
 8 W - Ø 45 x 80 mm - 33 g

E27	4 W = 30 W	350 lm	200°	3000 K	HR80H1G-042730	10/50	2,00 €
				4000 K	HR80H1G-042740		
				6500 K	HR80H1G-042764		
	6 W = 40 W	490 lm	200°	3000 K	HR80H1G-062730	10/50	2,40 €
				4000 K	HR80H1G-062740		
				6500 K	HR80H1G-062765		
	8 W = 60 W	806 lm	180°	3000 K	HR80H1G-082730	10/50	3,10 €
				4000 K	HR80H1G-082740		
				6500 K	HR80H1G-082765		

220-240 V
 IP20
 6 W

Massima qualità della luce e possibilità di scelta tra diverse temperature di colore luce.
 Maximum light quality and choice between different light color temperatures.

SORGENTI CLASSICHE
HARMONY



4 W - 6 W - Ø 37 x 100 mm - 20 g
 8 W - Ø 37 x 106 mm - 30 g

CANDELA

E14	4 W = 30 W	350 lm	△ 200°	3000 K	HR80M1-041430	10/50	2,00 €
				4000 K	HR80M1-041440		
				6500 K	HR80M1-041464		
	6 W = 40 W	490 lm	△ 220°	3000 K	HR80M1-061430	10/50	2,40 €
				4000 K	HR80M1-061440		
				6500 K	HR80M1-061465		
	8 W = 60 W	806 lm	△ 220°	3000 K	HR80M1-081430	10/50	3,10 €
				4000 K	HR80M1-081440		
				6500 K	HR80M1-081465		



Ø 37 x 124 mm - 23 g

COLPO DI VENTO

E14	6 W = 40 W	490 lm	△ 220°	3000 K	HR80M1C-061430	10/50	2,40 €
				4000 K	HR80M1C-061440		
				6500 K	HR80M1C-061465		

Massima qualità della luce e possibilità di scelta tra diverse temperature di colore luce.
 Maximum light quality and choice between different light color temperatures.

SORGENTI SPOT
LEXAR



Ø 50 x 54 mm - 31 g

35°		OUTPUT 360°	OUTPUT 90°				
GU10 △ 35°	5 W = 40 W	450 lm	380 lm	3000 K	LX38-061030	10/50	4,20 €
				4000 K	LX38-061040		
				6500 K	LX38-061060		
	6,5 W = 50 W	550 lm	500 lm	3000 K	LX38-081030	10/50	4,70 €
				4000 K	LX38-081040		
				6500 K	LX38-081060		

220-240 V IP20



Ø 50 x 54 mm - 31 g

105°		OUTPUT 360°	OUTPUT 120°				
GU10 △ 105°	5 W = 40 W	450 lm	380 lm	3000 K	LX110-061030	10/50	4,20 €
				4000 K	LX110-061040		
				6500 K	LX110-061060		
	6,5 W = 50 W	550 lm	500 lm	3000 K	LX110-081030	10/50	4,70 €
				4000 K	LX110-081040		
				6500 K	LX110-081060		

220-240 V IP20

Disponibili in diverse temperature di colore luce, sono adatte sia per l'illuminazione d'accento che per quella generica.
Available in different color temperatures and suitable for both accent and general lighting.

SORGENTI SPOT
LEXAR

SORGENTI

GO SMART

VERSATILI

INDOOR

OUTDOOR

SOLARI

WORK

PROFESSIONAL

ESPOSITORI



Ø 50 x 55 mm - 25 g

110°		OUTPUT 360°	OUTPUT 120°				
GU10 △ 110°	9 W = 50 W	1.000 lm	750 lm	3000 K	LX110-091030	10/50	6,20 €
				4000 K	LX110-091040		
				6500 K	LX110-091060		

220-240 V IP20



Ø 50 x 46 mm - 26 g

60°		OUTPUT 360°	OUTPUT 120°				
GU5.3 △ 60°	5 W = 40 W	400 lm	350 lm	3000 K	LX60-065330	10/50	6,20 €
				4000 K	LX60-065340		
				6500 K	LX60-065360		
	6,5 W = 50 W	500 lm	450 lm	3000 K	LX60-085330	10/50	6,90 €
				4000 K	LX60-085340		
				6500 K	LX60-085360		

12 V IP20

TECHNICAL NOTES

ALIMENTAZIONE CON TRASFORMATORI ELETTROMAGNETICI E NON ELETTRONICI
POWER SUPPLY WITH ELECTROMAGNETIC AND NON-ELECTRONIC TRANSFORMERS

NON ADATTE AD ESSERE ALIMENTATE DALLA CONVENZIONALE RETE ELETTRICA
NOT SUITABLE TO BE POWERED BY CONVENTIONAL MAINS



Disponibili in diverse temperature di colore luce, sono adatte sia per l'illuminazione d'accento che per quella generica.
Available in different color temperatures and suitable for both accent and general lighting.

SORGENTI SPOT

SPOT MULTILED



Ø50 x 60 mm - 25 g

110°						
GU10 110°	7 W = 50 W	600 lm	3000 K	K2T7LED-071030	6/24	3,20 €
			4000 K	K2T7LED-071040		
			6500 K	K2T7LED-071060		
220-240 V IP20						

SORGENTI SPOT

SPOT MAXILED

12 V AC/DC

12 V
AC/DC



Ø 35 x 40 mm - 15 g

36°		OUTPUT 360°	OUTPUT 90°			
MR11 36°	2,3 W = 20 W	235 lm	200 lm	3000 K	K12XLED-300430	6/24
				4000 K	K12XLED-300440	
12 V IP20						

TECHNICAL NOTES

ALIMENTAZIONE CON TRASFORMATORI ELETTROMAGNETICI E NON ELETTRONICI
POWER SUPPLY WITH ELECTROMAGNETIC AND NON-ELECTRONIC TRANSFORMERS

NON ADATTE AD ESSERE ALIMENTATE DALLA CONVENZIONALE RETE ELETTRICA
NOT SUITABLE TO BE POWERED BY CONVENTIONAL MAINS

NO 230 V/AC

Disponibili in diverse temperature di colore luce, sono adatte sia per l'illuminazione d'accento che per quella generica.
Available in different color temperatures and suitable for both accent and general lighting.

SORGENTI SPOT
DICRO SHOP 95

CRI 95 - DIMMABLE



Ø50 x 55 mm - 25 g

35°		OUTPUT 360°	OUTPUT 90°				
Ψ GU10 △ 35°	6 W = 40 W	350 lm	315 lm	3000 K	DSD-063830	10/50	8,50 €
				4000 K	DSD-063840		
				6500 K	DSD-063860		

220-240 V IP20

DIMMABLE CRI 95

TECHNICAL NOTES

DIMMERABILE CON SISTEMI A TAGLIO DI FASE
DIMMABLE WITH TRAILING-EDGE SYSTEMS

R9>50

SORGENTI SPOT
DICRO SHOP 90

R9>50 - CRI 90 - DIMMABLE



Ø 50 x 54 mm - 72 g

12°		OUTPUT 360°	OUTPUT 90°				
Ψ GU10 △ 12°	6,5 W = 50 W	550 lm	500 lm	3000 K	DSD-061230	10/50	20,00 €
				4000 K	DSD-061240		
				6500 K	DSD-061260		

220-240 V IP20

HIGH DISSIPATION ALUMINUM **DIMMABLE** R9>50 CRI 90 3 YEARS

TECHNICAL NOTES

DIMMERABILE CON SISTEMI A TAGLIO DI FASE
DIMMABLE WITH TRAILING-EDGE SYSTEMS

R9>50 - RENDE I COLORI ROSSI FORTI E BRILLANTI
R9>50 - MAKES RED COLORS STRONG AND BRIGHT

OTTICA STUDIATA PER UN'ELEVATA CONCENTRAZIONE DEL FASCIO LUMINOSO
OPTICS DESIGNED FOR A HIGH CONCENTRATION OF THE LIGHT BEAM



Disponibili in diverse temperature di colore luce, sono adatte sia per l'illuminazione d'accento che per quella generica.
Available in different color temperatures and suitable for both accent and general lighting.

SORGENTI SPECIALI
PIXY G4

12 V
AC/DC



Ø 14 x 51 mm - 10 g

COB 2 W

G4	2 W = 20 W	200 lm	3000 K	PIXYCOB-020430	12/96	5,00 €
			4000 K	PIXYCOB-020440		
			6500 K	PIXYCOB-020464		

12 V IP20 300°
~ --- / \ /



Ø 30 x 43 mm - 4 g

PLATE 1,8 W

G4	1,8 W = 20 W	170 lm	3000 K	PIXYPLT-020430	12/96	5,00 €
----	--------------	--------	--------	-----------------------	-------	--------

12 V IP20 180°
~ --- / \ /



Ø 14 x 48 mm - 10 g

3 W

G4	3 W = 30 W	300 lm	3000 K	PIXYFULL-030430	12/96	5,70 €
			4000 K	PIXYFULL-030440		
			6500 K	PIXYFULL-030464		

12 V IP20 300°
~ --- / \ /



Ø 16 x 57 mm - 13 g

4,5 W

G4	4,5 W = 40 W	540 lm	3000 K	PIXYFULL-450430	12/96	7,00 €
			4000 K	PIXYFULL-450440		
			6500 K	PIXYFULL-450464		

12 V IP20 300°
~ --- / \ /

TECHNICAL NOTES

NON ADATTE AD ESSERE ALIMENTATE DALLA CONVENZIONALE RETE ELETTRICA
NOT SUITABLE TO BE POWERED BY CONVENTIONAL MAINS

NO 230 V/AC

Design trasparente ed elegante. Si alimenta con trasformatori elettromagnetici e non elettronici.
Transparent and elegant design. Powered by electromagnetic and non-electronic transformers.

SORGENTI SPECIALI
PIXY G9



Ø 15 x 48 mm - 11 g

3 W						
G9	3 W = 30 W	270 lm	3000 K	PIXYFULL-030930	12/96	4,50 €
			4000 K	PIXYFULL-030940		
			6500 K	PIXYFULL-030964		

220-240 V IP20 300°



Ø 16 x 60 mm - 14 g

4 W						
G9	4 W = 40 W	450 lm	3000 K	PIXYFULL-040930	12/96	5,50 €
			4000 K	PIXYFULL-040940		
			6500 K	PIXYFULL-040964		

220-240 V IP20 300°



Ø 14 x 64 mm - 10 g

COB 4 W						
G9	4 W = 40 W	470 lm	3000 K	PIXYCOB-040930	12/96	6,40 €
			4000 K	PIXYCOB-040940		
			6500 K	PIXYCOB-040964		

220-240 V IP20 300°



Ø 16 x 60 mm - 15 g

4,8 W						
G9	4,8 W = 40 W	470 lm	3000 K	PIXYFULL-050930	12/96	6,20 €
			4000 K	PIXYFULL-050940		
			6500 K	PIXYFULL-050964		

220-240 V IP20 300°



Ø 18 x 75 mm - 22 g

8 W						
G9	8 W = 60 W	800 lm	3000 K	PIXYFULL-080930	12/96	8,50 €
			4000 K	PIXYFULL-080940		
			6500 K	PIXYFULL-080964		

220-240 V IP20 300°

Design trasparente ed elegante. Si alimenta con corrente a 220 V (senza trasformatore).
Transparent and elegant design. Powered by 220 V current (without transformer).

SORGENTI SPECIALI

PIXYFULL DIMMERABILE



DIMMABLE



	A mm	B mm	g
4,5 W	Ø19	55	10
6,5 W	Ø21	70	25

G9	4,5 W = 35 W	430 lm	3000 K	PIXYDIM-450930	12/96	7,50 €
			4000 K	PIXYDIM-450940		
			6000 K	PIXYDIM-450960		
	6,5 W = 50 W	620 lm	3000 K	PIXYDIM-650930	12/96	8,50 €
			4000 K	PIXYDIM-650940		
			6000 K	PIXYDIM-650960		

220-240 V IP20 330°

DIMMABLE

TECHNICAL NOTES



DIMMERABILE CON SISTEMI A TAGLIO DI FASE
DIMMABLE WITH TRAILING-EDGE SYSTEMS

Lampada speciale LED G9, trasparente e dimmerabile.
Special transparent and dimmable G9 LED lamp.



TRE-D COB



4 W - Ø 16 x 78 mm - 10 g
8 W - Ø 16 x 118 mm - 20 g
11 W - Ø 18 x 118 mm - 23 g

COB R7s	4 W = 40 W	450 lm	Color Box	3000 K	TRCOB-047830	6/24	11,00 €		
				4000 K	TRCOB-047840				
				Blister	3000 K	TRCOB-047830BL	6/24	12,00 €	
					4000 K	TRCOB-047840BL			
	8 W = 70 W	1.000 lm	Color Box		3000 K	TRCOB-0811830	6/24	15,00 €	
					4000 K	TRCOB-0811840			
				Blister		3000 K	TRCOB-0811830BL	6/24	15,50 €
						4000 K	TRCOB-0811840BL		
11 W = 100 W	1.500 lm	Color Box		3000 K	TRCOB-1111830 <small>NEW</small>	6/24	20,00 €		
				4000 K	TRCOB-1111840 <small>NEW</small>				

11 W 4-8 W 220-240 V IP20 330°



Ø 28 x 118 mm - 60 g

TRE-D

R7s	14 W = 120 W	1.900 lm	No Dimm.	3000 K	TR-1411830BL	6/24	17,50 €
				4000 K	TR-1411840BL		
			Dimm.	3000 K	TRD-1411830BL	6/24	19,50 €
				4000 K	TRD-1411840BL		

220-240 V IP20 330°

TRD DIMMABLE

TECHNICAL NOTES



DIMMERABILE CON SISTEMI A TAGLIO DI FASE
DIMMABLE WITH TRAILING-EDGE SYSTEMS

TRE-D SLIM



5 W - Ø 15 x 78 mm - 23 g
9 W - Ø 15 x 118 mm - 35 g

R7s	5 W = 50 W	490 lm	Blister	3000 K	TRS-057830BL	6/24	8,50 €
	9 W = 70 W	950 lm	Blister	3000 K	TRS-0811830BL	6/24	12,00 €

220-240 V IP20 330°

ULTRASLIM

Lampada LED R7S. Elevate prestazioni in dimensioni ridotte.
R7S LED lamp. High performance in short size.

NEW

SORGENTI SPECIALI

ARIA BT

12-24 V
AC/DC

12-24 V AC/DC



Ø 60 x 119 mm - 124 g

Goccia E27	12 W = 85 W	1.280 lm	3000 K	ABTG3-122430 <small>NEW</small>	10/50	12,00 €
			4000 K	ABTG3-122440 <small>NEW</small>		

12-24 V IP20 270°



Ø 45 x 80 mm - 16 g

Sfera E14	5 W = 40 W	450 lm	3000 K	ABTH1G-051430	10/50	9,70 €
			4000 K	ABTH1G-051440		

12-24 V IP20 200°



Ø 45 x 80 mm - 18 g

Sfera E27	5 W = 40 W	450 lm	3000 K	ABTH1G-052730	10/50	9,70 €
			4000 K	ABTH1G-052740		

12-24 V IP20 200°



Ø 37 x 100 mm - 18 g

Candela E14	5 W = 40 W	450 lm	3000 K	ABTM1-051430	10/50	9,70 €
			4000 K	ABTM1-051440		

12-24 V IP20 220°



Ø 50 x 50 mm - 20 g

Spot GU5.3	5 W = 40 W	360 lm	3000 K	ABT38-055330	10/50	9,70 €
			4000 K	ABT38-055340		

12-24 V IP20 38°

TECHNICAL NOTES

NON ADATTE AD ESSERE ALIMENTATE DALLA CONVENZIONALE RETE ELETTRICA
NOT SUITABLE TO BE POWERED BY CONVENTIONAL MAINS

NO 230 V/AC

Lampada a bassa tensione con range di utilizzo 12-24 V AC/DC. Un prodotto versatile che garantisce massima qualità della luce.
Low voltage lamp with 12-24 V AC / DC range. A versatile product for maximum light quality.

NEW

SORGENTI SPECIALI
SENSOR



DAY & NIGHT - MOTION SENSOR



Ø 60 x 120 mm - 36 g

DAY & NIGHT

Goccia E27	11 W = 75 W	1.055 lm	3000 K	HR80G3S-112730 NEW	6/24	7,50 €
			4000 K	HR80G3S-112740 NEW		
			6500 K	HR80G3S-112765 NEW		

220-240 V IP20 200° 0,5 W
Stand By

AUTOMATIC LIGHT SENSOR

AUTOMATIC

In condizione di scarsa luminosità, la lampadina si accende automaticamente e si spegnerà da sola quando il livello di luce ambientale sarà di nuovo sufficiente.
In low light conditions, the bulb will turn on automatically and switch off by itself when the ambient light level is sufficient again.

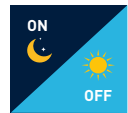

Ø 60 x 120 mm - 32 g

MOTION SENSOR

Goccia E27	11 W = 75 W	1.055 lm	3000 K	HR80G3SP-112730 NEW	6/24	11,50 €
			4000 K	HR80G3SP-112740 NEW		
			6500 K	HR80G3SP-112765 NEW		

220-240 V IP20 200° 0,5 W
Stand By

AUTOMATIC LIGHT SENSOR MICROWAVE SENSOR

AUTOMATIC

In condizione di scarsa luminosità, la lampadina si accende automaticamente al rilevamento di un movimento.
In low light conditions, the light bulb will turn on automatically upon detecting motion.



Se non viene rilevato movimento entro 3 minuti, la lampada si spegne.
If any movement is not detected within 3 minutes, the lamp switches off.



La lampadina rimane spenta in condizione di sufficiente luce naturale.
In good lighting conditions, the light bulb will remain off.



TECHNICAL NOTES



ON-OFF AUTOMATICO GIORNO-NOTTE
AUTOMATIC DAY-NIGHT ON-OFF

L'On-Off automatico giorno-notte e il rilevamento di movimento garantiscono un risparmio energetico ottimale. La tecnologia avanzata dei sensori permette un'illuminazione intelligente e affidabile, attivandosi solo quando necessario.

The automatic day-night On-Off and motion detection ensure optimal energy savings. Advanced sensor technology allows for intelligent and reliable lighting, activating only when necessary.

SORGENTI SPECIALI
CIRCOLINA



	A mm	g
12 W	Ø180	110
18 W	Ø218	160
23 W	Ø253	180

Connection with terminal	12 W	1.250 lm	3000 K	CRL-1218030	1/20	16,90 €
			4000 K	CRL-1218040		
	18 W	1.900 lm	3000 K	CRL-1821830	1/20	20,50 €
			4000 K	CRL-1821840		
	23 W	2.450 lm	3000 K	CRL-2425330	1/20	24,50 €
			4000 K	CRL-2425340		

220-240 V
 IP20
 120°

MAGNETIC
 EASY TO INSTALL
 2-in-1 INSTALLATION

INSTALLATION



**RINNOVA LA TUA PLAFONIERA GRAZIE ALLA DOPPIA INSTALLAZIONE:
 FISSAGGIO CON MAGNETI O TRAMITE APPLICAZIONE CLASSICA CON VITI
 RENOVATE YOUR CEILING LIGHT THANKS TO THE DOUBLE INSTALLATION:
 FIXING WITH MAGNETS OR BY CLASSIC APPLICATION WITH SCREWS**

Doppio sistema di montaggio: fissaggio con magneti nelle plafoniere già esistenti o fissaggio classico tramite viti.
 Double mounting system: magnet fixing installation for existing ceiling lights or classic screw fixing.

SORGENTI SPECIALI
KILLER 50

ANTIZANZARA LED



Ø 60 x 110 mm - 39 g

Goccia E27	9 W = 50 W	650 lm	2200 K	KLRSC-092700	1/25	9,50 €
220-240 V	IP20	230°				

IN VENDITA CON ESPOSITORE DA 25 PZ
25 PCS DISPLAY READY FOR SALE



Questa lampada gialla filtra i raggi infrarossi UV per creare una lunghezza d'onda che tiene lontane le zanzare. Copre una superficie fino a 16 m², è atossica, inodore e sicura per persone e animali.
This yellow lamp filters UV infrared rays to create a wavelength that repels mosquitoes. It covers an area of up to 16 m² and is non-toxic, odorless, and safe for humans and animals.

SORGENTI SPECIALI
VOTIVA

24 V AC/DC

24 V
AC/DC



Ø 21 x 59 mm - 14 g

Candela E14	0,4 W	25 lm	2700 K	VTV-052427	50/200	2,20 €
24 V	IP20	180°				

TECHNICAL NOTES

NON ADATTA AD ESSERE ALIMENTATA DALLA CONVENZIONALE RETE ELETTRICA
NOT SUITABLE TO BE POWERED BY CONVENTIONAL MAINS

NO 230 V/AC

SORGENTI SPECIALI
LAMPADA FRIGO



Ø 18 x 50 mm - 10 g

E14	1,8 W = 40 W	130 lm	2700 K	FGF-011427	12/48	3,75 €
			5000 K	FGF-011450		
220-240 V	IP20	300°				

SORGENTI SPECIALI
LAMPADA FORNO

HALOGEN



Ø 22 x 50 mm - 6 g

E14	15 W Halogen	90 lm	2200 K	PE1514FORBL	12/48	4,00 €
220-240 V	IP20	360°				

300° C
DIMMABLE MAX TEMPERATURE

TECHNICAL NOTES



DIMMERABILE CON SISTEMI A TAGLIO DI FASE
DIMMABLE WITH TRAILING-EDGE SYSTEMS

SORGENTI

GO SMART

VERSATILI

INDOOR

OUTDOOR

SOLARI

WORK

PROFESSIONAL

ESPOSITORI

SORGENTI PROFESSIONALI

MAXIMA



40 W - Ø 78 x 151 mm - 265 g
 70 W - Ø 88 x 180 mm - 396 g
 100 W - Ø 98 x 198 mm - 511 g
 150 W - Ø 114 x 230 mm - 748 g

E27	40 W	4.300 lm	4000 K	MX-402740	5/20	75,00 €
	70 W	7.600 lm	4000 K 6500 K	MX-704040 MX-704065	5/20	112,00 €
E40	100 W	10.950 lm	4000 K	MX-1004040	5/20	127,00 €
			6500 K	MX-1004065		
	150 W	16.490 lm	4000 K 6500 K	MX-1504040 MX-1504065	5/20	190,00 €

175-250 V IP20 200°

HIGH DISSIPATION DIE CAST ALUMINUM

TECHNICAL NOTES

IN SOSTITUZIONE DI LAMPADE TRADIZIONALI AL CORPO PRODOTTO
 VA RIMOSSO IL REATTORE E CABLATO DIRETTAMENTE A 230 V
 TO REPLACE TRADITIONAL LAMPS, THE BALLAST MUST BE REMOVED
 FROM THE PRODUCT BODY AND WIRED DIRECTLY TO 230 V

IDONEO PER SOSPENSIONI INDUSTRIALI APERTE
 SUITABLE FOR OPEN INDUSTRIAL SUSPENSION

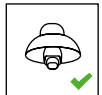

Corpo in alluminio pressofuso verniciato a polveri epossidiche. Idonea per sospensioni industriali aperte in ambienti interni.
 Body in die-cast aluminum painted with epoxy powders. Suitable for open industrial suspensions in indoor environments.

SORGENTI PROFESSIONALI

LOTUS

HIGH POWER



30 W - Ø 96 x 228 mm - 265 g
 50 W - Ø 108 x 264 mm - 330 g
 50 W E40 - Ø 108 x 274 mm - 405 g

E27	30 W	2.800 lm	1800 K	LTS-302718	1/20	31,00 €
			3000 K 4000 K	LTS-302730 LTS-302740	1/20	30,00 €
		50 W	4.250 lm	1800 K	LTS-502718	1/20
5.400 lm	2200 K		LTS-502722	1/20	43,00 €	
	3000 K 4000 K		LTS-502730 LTS-502740			
E40	50 W	5.400 lm	2200 K	LTS-504022	1/20	45,50 €
			3000 K	LTS-504030		
			4000 K	LTS-504040		

220-240 V IP20 330°

HIGH DISSIPATION

INSTALLATION

IDONEA PER AMBIENTI ESTERNI IN APPARECCHI IP65
 SUITABLE FOR OUTDOOR ENVIRONMENTS IN IP65 LUMINAIRES

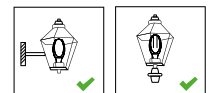

Lampada ad alta potenza simile alle tradizionali SAP, garantisce una luce morbida e uniforme. Ottima dissipazione e idonea all'uso prolungato.
 High-power lamp with SAP traditional shape, for a soft and uniform light. Excellent dissipation suitable for prolonged use.

SORGENTI PROFESSIONALI
PLOSE STREET

ORIENTABLE



0-350° Ø 90 x 260 mm - 634 g

E40	54 W	8.000 lm	4000 K	PSS-544040	5/20	96,00 €
-----	------	----------	--------	-------------------	------	---------

220-240 V IP20 IK08 120°

ORIENTABLE HIGH DISSIPATION ALUMINUM

TECHNICAL NOTES

INSTALLATION

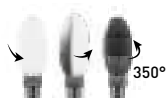

ROTAZIONE SU ASSE 0-350°
ROTATION ON AXIS 0-350°



IDONEA PER AMBIENTI ESTERNI IN APPARECCHI IP65
SUITABLE FOR OUTDOOR ENVIRONMENTS IN IP65 LUMINAIRES

Speciale lampada auto dissipante ideale per il relamping LED degli apparecchi. Idonea per apparecchi chiusi IP65.
Rotazione su asse di 350° per direzionare il flusso luminoso verso l'area desiderata.
Special self-dissipating lamp ideal for LED relamping of luminaires. Suitable for IP65 closed luminaires.
350° rotation on axis to direct the luminous flux towards the desired area.

SORGENTI PROFESSIONALI

PLOSE

HIGH POWER



30 W - Ø 73 x 175 mm - 430 g
40 W - Ø 73 x 180 mm - 450 g
E40 - Ø 73 x 195 mm - 460 g

E27	30 W	4.300 lm	3000 K	PSE-302730	5/20	60,00 €
			4000 K	PSE-302740		
			6500 K	PSE-302765		
E40	40 W	5.700 lm	3000 K	PSE-402730	5/20	81,50 €
			4000 K	PSE-402740		
			6500 K	PSE-402765		
E40	40 W	5.700 lm	3000 K	PSE-404030	5/20	86,50 €
			4000 K	PSE-404040		
			6500 K	PSE-404065		

100-240 V IP20 IK08 280° x 360°

HIGH DISSIPATION ALUMINUM 50.000 h

TECHNICAL NOTES

INSTALLATION

ANGOLO LUCE DI 360° ORIZZONTALE E 280° VERTICALE
360° HORIZONTAL AND 280° VERTICAL LIGHT BEAM

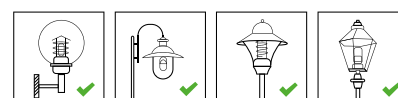

IDONEA PER AMBIENTI ESTERNI IN APPARECCHI IP65
SUITABLE FOR OUTDOOR ENVIRONMENTS IN IP65 LUMINAIRES

Applicabile in apparecchi con grado di protezione IP65, angolo luce di 360° su piano orizzontale ed elevata resa luminosa
Suitable for IP65 fixtures, 360° light beam angle on horizontal axis and high light output.

SORGENTI PROFESSIONALI
SERIE LIGHT



8 W - Ø 50 x 85 mm - 27 g
10 W - Ø 63 x 100 mm - 40 g
15 W - Ø 80 x 114 mm - 77 g

E14 120°	5 W = 40 W	400 lm	3000 K	LR50-051430	6/24	4,50 €
			4000 K	LR50-051440		
E27 120°	9 W = 60 W	820 lm	3000 K	LR63-082730	6/24	6,20 €
			4000 K	LR63-082740		
	15 W = 100 W	1.521 lm	3000 K	LR80-152730	6/24	8,40 €
			4000 K	LR80-152740		

220-240 V IP20
LR50



8 W - Ø 63 x 89 mm - 54 g
10 W - Ø 95 x 105 mm - 96 g
15 W - Ø 121 x 140 mm - 125 g

		OUTPUT 360°	OUTPUT 90°				
E27 38°	8 W	750 lm	640 lm	3000 K	PAR20-082730	6/24	6,70 €
				4000 K	PAR20-082740		
	10 W	870 lm	730 lm	3000 K	PAR30-102730	6/24	11,20 €
				4000 K	PAR30-102740		
	15 W	1.270 lm	1.100 lm	3000 K	PAR38-152730	6/24	13,50 €
				4000 K	PAR38-152740		

220-240 V IP20 38°

TECHNICAL NOTES

SPECIALELENTE PER OMOGENEITÀ DEL FASCIO LUMINOSO
SPECIAL LENS FOR UNIFORMITY LIGHT BEAM

SORGENTI PROFESSIONALI

PAR56

IP68 - 12 V AC/DC



Ø 176 x 110 mm - 940 g

30 W = 300 W	3.375 lm	4000 K	PAR56-301640	1/12	170,00 €
--------------	----------	--------	---------------------	------	----------

12 V IP68 90°

TEMPERED GLASS

TECHNICAL NOTES

LAMPADA PER PISCINE IN VETRO TEMPERATO ANTI INVECCHIAMENTO
ANTI-AGING TEMPERED GLASS POOL LAMP

INSTALLATION



INSTALLAZIONE RAPIDA CON MONTAGGIO A VITE
QUICK INSTALLATION WITH SCREW MOUNT



SORGENTI PROFESSIONALI

AR111



Ø 111 x 57 mm - 165 g

CITYLAMP	OUTPUT 360°	OUTPUT 90°					
Connection with terminal	15 W = 100 W	1.200 lm	1.100 lm	3000 K	CL-152430	6/24	20,00 €
				4000 K	CL-152440		

220-240 V IP20 24°

INCLUDED



DRIVER ESTERNO EXTERNAL DRIVER



Ø 111 x 68 mm - 118 g

CITYLAMP GU10	OUTPUT 360°	OUTPUT 90°					
GU10	15 W = 100 W	1.200 lm	1.100 lm	3000 K	CLGU10-153830	6/24	15,60 €
				4000 K	CLGU10-153840		

220-240 V IP20 38°



Ø 111 x 65 mm - 130 g

SUPERLED	OUTPUT 360°	OUTPUT 90°					
G53	12 W	1.020 lm	900 lm	3000 K	SLAR111-124030	10/50	16,00 €
				4000 K	SLAR111-124040		

12 V IP20 38°

TECHNICAL NOTES

ALIMENTAZIONE CON TRASFORMATORI ELETTROMAGNETICI
POWER SUPPLY WITH ELECTROMAGNETIC TRANSFORMERS

SORGENTI PROFESSIONALI

PL-COVER

E27 - G24d



E27 G24d
35 x 165 x 35 mm - 125 g

E27	10 W = 18 W	800 lm	120°	4000 K	PLC-102740	10/50	22,00 €
G24d 2 pin	10 W = 18 W	930 lm	180°	4000 K	PLC-102440	6/24	

220-240 V IP20

OPAL DIFFUSER

TECHNICAL NOTES

SI RACCOMANDA, PRIMA DELL'INSTALLAZIONE, DI RIMUOVERE
OGNI ALIMENTATORE ELETTRONICO ED ELETTROMAGNETICO PRESENTE NEL CORPO ILLUMINANTE.
BEFORE INSTALLING, IT IS RECOMMENDED TO REMOVE
EACH ELECTRONIC AND ELECTROMAGNETIC BALLAST PRESENT IN THE LIGHTING FIXTURE.

SORGENTI PROFESSIONALI

GXLED

GX53



Ø 74 x 28 mm - 46 g

GX53	5 W = 40 W	470 lm	3000 K	GXLED-055330	6/24	13,70 €
			4000 K	GXLED-055340		

220-240 V IP20 120°

PLASTIC HEATSINK OPAL PC DIFFUSER

CELESTURY®



02



GO SMART
 GO SMART
 GO SMART

 **LAMPADE SMART 3 CCT**
 GOCCIA RGB
 GOCCIA FILAMENTO
 SFERA RGB
 CANDELA RGB
 SPOT RGB

 **STRIP**
 ACCÈNTO SMART RGB+W
 CONTROLLER WI-FI RGB+W

 **PLAFONIERE**
 BLANCA SMART

 **DOWNLIGHT**
 SPOTFIVE SMART

 **SPECIALI**
 INTERRUTTORE SMART
 SMART POWER

SORGENTI

GO SMART

VERSATILI

INDOOR

OUTDOOR

SOLARI

WORK

PROFESSIONAL

ESPOSITORI



La domotica senza costi!
Domotic without costs!

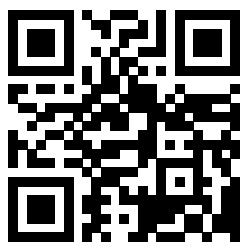

Guarda il video dimostrativo
Watch the demonstrative video





Milioni di colori

Il colore è emozione, energia, stato d'animo. Crea la **giusta atmosfera** per ogni occasione grazie alle **infinite possibilità di scelta**.

Millions of colors

Color is emotion, energy, mood. Create the **right atmosphere** for any occasion thanks to the **endless possibilities of choice**.



Controllo vocale

Puoi usare la tua voce per chiedere agli **assistenti virtuali** Alexa o Google Assistant di accendere la luce, regolare il colore e la luminosità.

Voice control

You can use your voice to ask **virtual assistants** Alexa or Google Assistant to turn on the light, adjust color and brightness.



Bianco puro, alta luminosità

Quando c'è bisogno di luce **scegli il bianco**. Imposta un bianco freddo per leggere o studiare e un bianco caldo per le attività meno impegnative.

Pure white, high brightness

When there is a need for light, **choose white**. Set cool white when reading or studying and warm white for less demanding activities.



Crea i tuoi gruppi

Raggruppa i tuoi dispositivi GO SMART per un **controllo sincronizzato**. Tutta la luce della tua casa sarà nel palmo di una mano!

Create your groups

Group your GO SMART devices together for **synchronized control**. All the light in your home will be in the palm of your hand!

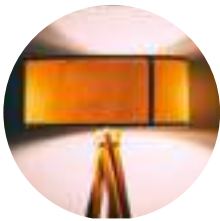

Dimmerabile

Regola la luminosità in base alle tue esigenze: la casa è un luogo dinamico e la luce sa adattarsi benissimo.

Dimmable

Adjust the **brightness** according to your needs: your home is a dynamic place and the light adapts perfectly.



Ovunque sei

Puoi **controllare e regolare** la luce sia in casa che fuori. Non è necessario alcun dispositivo di rete aggiuntivo basta solo uno smartphone.

Wherever you are

You can **control and adjust** your light both **indoors and out**. It is not needed no hub are enough just a smartphone.



Timer ON / OFF

Adatta la luce alla tua routine. Puoi **programmare l'accensione** insieme alla sveglia oppure lo **spegnimento notturno** nella stanza dei bambini.

Timer ON / OFF

Adapt your light to your routine. You can program it to **switch on** together with your alarm clock or **switch it off at night** in the children's room.



[century-italia.it/go-smart](https://www.century-italia.it/go-smart)



Powered by



1. Scarica e installa l'App

Cerca l'App "Tuya Smart" su Apple Store o Google Play Store per scaricare ed installare l'applicazione.



2. Registrati ed esegui il login

Apri l'app Tuya e registrati attraverso il tuo numero di telefono o tramite email. Una volta effettuato l'accesso procedi alla creazione di una nuova Casa.



1. Download App

Search for "Tuya Smart" App on Apple Store or Google Play Store to download and install the application.



2. Register and log in

Open Tuya app and register with your phone number or by email. Proceed to create a new Home.

3. Aggiungi il dispositivo

Per aggiungere un dispositivo, assicurarsi che sia nello stato di connessione (la lampada lampeggia velocemente). A questo punto la lampada inizia a lampeggiare ed è pronta per la connessione.

Cliccare su "+" in alto a destra nella sezione "La mia casa" di Tuya Smart e scegli "Fonte di luce (Wi-Fi)" dal menù "Illuminazione", inserisci la password del Wi-Fi quindi per completare attendi il collegamento.

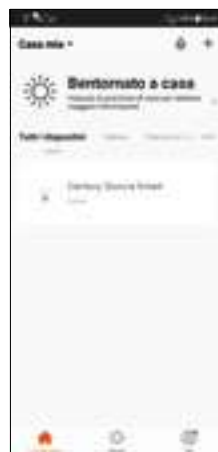

3. Add the device

To add a device, make sure it is in the connected state (the lamp blinks fast). At this point the lamp starts flashing and is ready for connection.

Click on "+" at the top right of the "My home" section of Tuya Smart and choose "Light source (Wi-Fi)" from the "Lighting" menu, enter the Wi-Fi password and then wait for the connection to complete.

4. Controlla il dispositivo

Una volta che il dispositivo è stato configurato con successo, il suo nome comparirà in lista nella schermata "La mia casa".

Premi su di esso per entrare nella schermata di controllo e premi al centro per accenderlo.

Divertiti a scoprire tutte le modalità della lampadina Smart.

Scegli una luce ideale per leggere, una per rilassarti oppure scopri le modalità per selezionare il colore della luce.

Pianifica l'accensione affinché la lampadina si accenda quando non sei in casa, oppure per svegliarti al mattino.

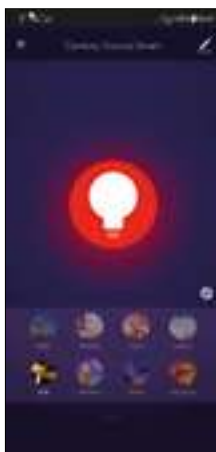

4. Control the device

Once the device has been successfully configured, its name will appear in the list on the screen "My home".

Press on it to enter its control screen and press the center to turn it on.

Have fun discovering all modes of Smart bulb.

Choose between an ideal light for reading, one for relaxing or discover the rotating modes of the light color. Schedule the ignition so that the light bulb turns on when you are not at home or to wake up in the morning.

Per l'integrazione con gli assistenti vocali Amazon Alexa e Google Assistant, la creazione di scenari o la condivisione di un dispositivo consultare il manuale di istruzioni del prodotto.
For integration with Amazon Alexa and Google Assistant voice assistants, creating scenarios or sharing a device, consult the product instruction manual.

GO SMART
LAMPADE SMART



Ø 65 x 134 - 60 g



GOCCIA RGB+TRICOLOR

E27	14 W = 100 W	1.400 lm	RGB + 3000 K - 6500 K	G3SMA-142700	10/50	21,50 €
220-240 V	IP20	220°		WIFI DIMMABLE	RGB CCT TRICOLOR	GO SMART



Ø 65 x 105 - 55 g



GOCCIA FILAMENTO TRICOLOR

E27	7 W = 60 W	806 lm	2700 K - 6500 K	ING3SMA-072700	10/50	16,50 €
220-240 V	IP20	330°		WIFI DIMMABLE	CCT TRICOLOR	GO SMART



Ø 47 x 88 - 24 g



SFERA RGB + TRICOLOR

E14	5,5 W = 40 W	470 lm	RGB + 3000 K - 6500 K	HIGSMA-061400	10/50	14,50 €
220-240 V	IP20	180°		WIFI DIMMABLE	RGB CCT TRICOLOR	GO SMART



Ø 37 x 106 - 25 g



CANDELA RGB + TRICOLOR

E14	5,5 W = 40 W	470 lm	RGB + 2700K - 6500K	M1SMA-061400	10/50	14,50 €
220-240 V	IP20	220°		WIFI DIMMABLE	RGB CCT TRICOLOR	GO SMART



Ø 50 x 56 - 27 g



SPOT RGB + TRICOLOR

GU10	5,5 W = 40 W	400 lm	120°	RGB + 2700 K - 6500 K	GUSMA120-061000	10/50	14,50 €
		345 lm	38°	RGB + 2700 K - 6500 K	GUSMA38-061000		
220-240 V	IP20				WIFI DIMMABLE	RGB CCT TRICOLOR	GO SMART

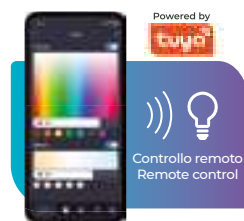

Controllo remoto
Remote control

- Timer ON / OFF
- Controllo funzioni di gruppo
Group function control
- Regolazione dei colori e del bianco
Adjusting colors and white
- Regolazione della luminosità
Brightness adjustment

Puoi controllarle con la tua voce!
You can control them with your voice!



Guarda il video dimostrativo
Watch the demonstrative video

GO SMART

ACCÈNTO SMART

STRIP LED RGB+W



WiFi

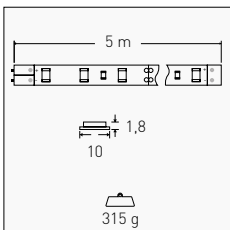

WHITE

24 W (4,8 W/m)	1.650 lm (330 lm/m)	RGB + 4000 K	ACRSMA-484800	10/20	72,00 €
220-240 V	IP20	120°	INDOOR	5 METERS	48 LED/m
					WIFI
					DIMMABLE
					RGB + W
					GO SMART

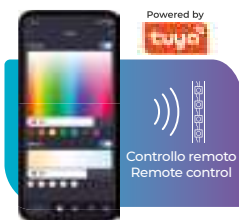

- Timer ON / OFF
- Controllo funzioni di gruppo
Group function control
- Regolazione dei colori e del bianco
Adjusting colors and white
- Regolazione della luminosità
Brightness adjustment

Puoi controllarla con la tua voce!
You can control it with your voice!



GO SMART

ACCÈNTO SMART

CONTROLLER RGB+W



CONTROLLER RGB+W WI-FI

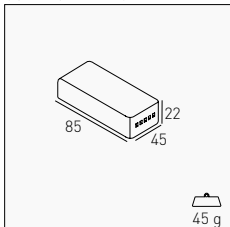

IN / OUT	CARICO MASSIMO / MAXIMUM LOAD	Model	Length	Price
12 - 24 V/DC	5 A x 4 Channel = 20 A / Max 120 W	CTL SMA-ACRGBW	10/180	32,50 €

IP20



RGB + W

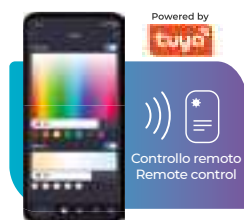

Powered by



Controllo remoto
Remote control



Timer ON / OFF



Controllo funzioni di gruppo
Group function control



Regolazione dei colori e del bianco
Adjusting colors and white



Regolazione della luminosità
Brightness adjustment

TECHNICAL NOTES

RENDE SMART LE STRIP LED RGB+W TRADIZIONALI
MAKES TRADITIONAL RGB+W STRIPS SMART

Puoi controllarlo con la tua voce!
You can control it with your voice!



COMPATIBILE CON COMPATIBLE WITH
ACRGBW-956030 - ACRGBW-956040 - ACRGBW-196010

GO SMART
BLANCA SMART

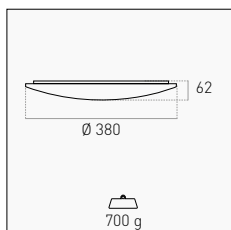

24 W	1.800 lm	3000 K - 6500 K	BCSMA-243800	1/10	62,50 €
Ⓢ 220-240 V ~	IP20 ⚡	120° ⬆️	ULTRASLIM	CCT TRICOLOR	GO SMART

Powered by **tuya**

Controllo remoto
Remote control

- Timer ON / OFF
- Controllo funzioni di gruppo
Group function control
- Regolazione dei colori e del bianco
Adjusting colors and white
- Regolazione della luminosità
Brightness adjustment
- Nessun hub richiesto
No hub required

Puoi controllarla con la tua voce!
You can control it with your voice!

amazon alexa works with the Google Assistant



Guarda il video dimostrativo
Watch the demonstrative video

GO SMART
SPOTFIVE SMART



SORSENTI

GO SMART

VERSATILI

INDOOR

OUTDOOR

SOLARI

WORK

PROFESSIONAL

ESPOSITORI

CCT

RGB + CCT

RGB + CCT

	A mm	B mm	Ø mm	g
12 W	Ø150	46	Ø125	200
18 W	Ø176	55	Ø150	356

12 W	750 lm	RGB + 2700 K - 6500 K	SPFRSMA-121400	10/20	60,00 €
18 W	1.170 lm	RGB + 3000 K - 6500 K	SPFRSMA-181900	10/20	77,00 €

100-240 V IP20 120°

ALUMINUM WIFI DIMMABLE RGB CCT TRICOLOR SMART

CCT

	Ø190	80	Ø150	310 g	
18 W	1.800 lm	3000 K - 6500 K	SPFSMA-181900	10/20	55,00 €
24 W	2.400 lm	3000 K - 6500 K	SPFSMA-241900	10/20	60,00 €

18 W	1.800 lm	3000 K - 6500 K	SPFSMA-181900	10/20	55,00 €
24 W	2.400 lm	3000 K - 6500 K	SPFSMA-241900	10/20	60,00 €

220-240 V IP20 120°

ALUMINUM WIFI DIMMABLE CCT TRICOLOR SMART

Puoi controllarli con la tua voce!
You can control them with your voice!



Guarda il video dimostrativo
Watch the demonstrative video

GO SMART
INTERRUTTORE SMART



1 TAP

2 TAPS

3 TAPS

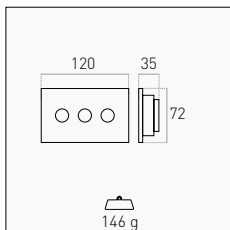

WIFI

2,4 GHz IEEE 802.11 b/g/n	1 Tap	SWSMA-1	1/4	50,50 €
	2 Taps	SWSMA-2	1/4	54,00 €
	3 Taps	SWSMA-3	1/4	62,50 €

IP20 MAX 5A



- Timer ON / OFF
- Controllo funzioni di gruppo
Group function control
- Countdown
- Nessun hub richiesto
No hub required

TECHNICAL NOTES

PER SCATOLE 503
FOR 503 BOX



INTERRUTTORI TOUCH SMART CONTROLLABILI DA REMOTO
 REMOTELY CONTROLLABLE TOUCH SMART SWITCHES



Puoi controllarli con la tua voce!
 You can control them with your voice!



WIRING DIAGRAMS

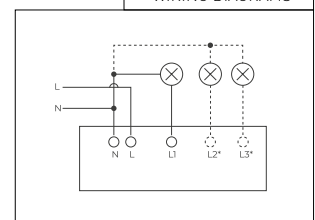





PLUG

SWITCH

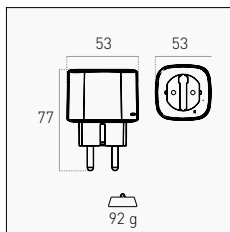
PLUG



Schuko (EU)	MAX 3.680 W	220-240 V/AC Max 16 A	SCKSMA	25/50 	31,00 €
-------------	-------------	-----------------------	---------------	---	---------

IP20





TECHNICAL NOTES

PRESA INTELLIGENTE CON ATTACCO SCHUKO
SMART PLUG WITH SCHUKO SOCKET

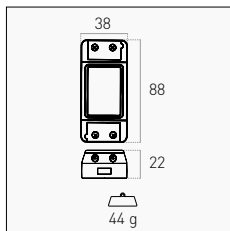
SWITCH



Cavo Cable	MAX 3.680 W	90-50 V/AC Max 16 A	CTLSMA	9/90 	21,50 €
------------	-------------	---------------------	---------------	--	---------





IP20



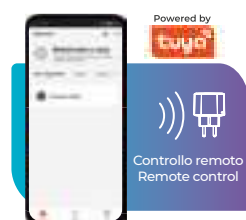

TECHNICAL NOTES

INTERRUTTORE INTELLIGENTE CON COLLEGAMENTO INFRACAVO
SMART SWITCH WITH IN-LINE CONNECTION

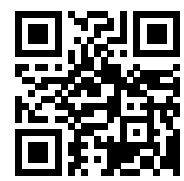

-  Timer ON / OFF
-  Controllo funzioni di gruppo
Group function control
-  Countdown
-  Nessun hub richiesto
No hub required

Puoi controllarli con la tua voce!
You can control them with your voice!



Guarda il video dimostrativo
Watch the demonstrative video

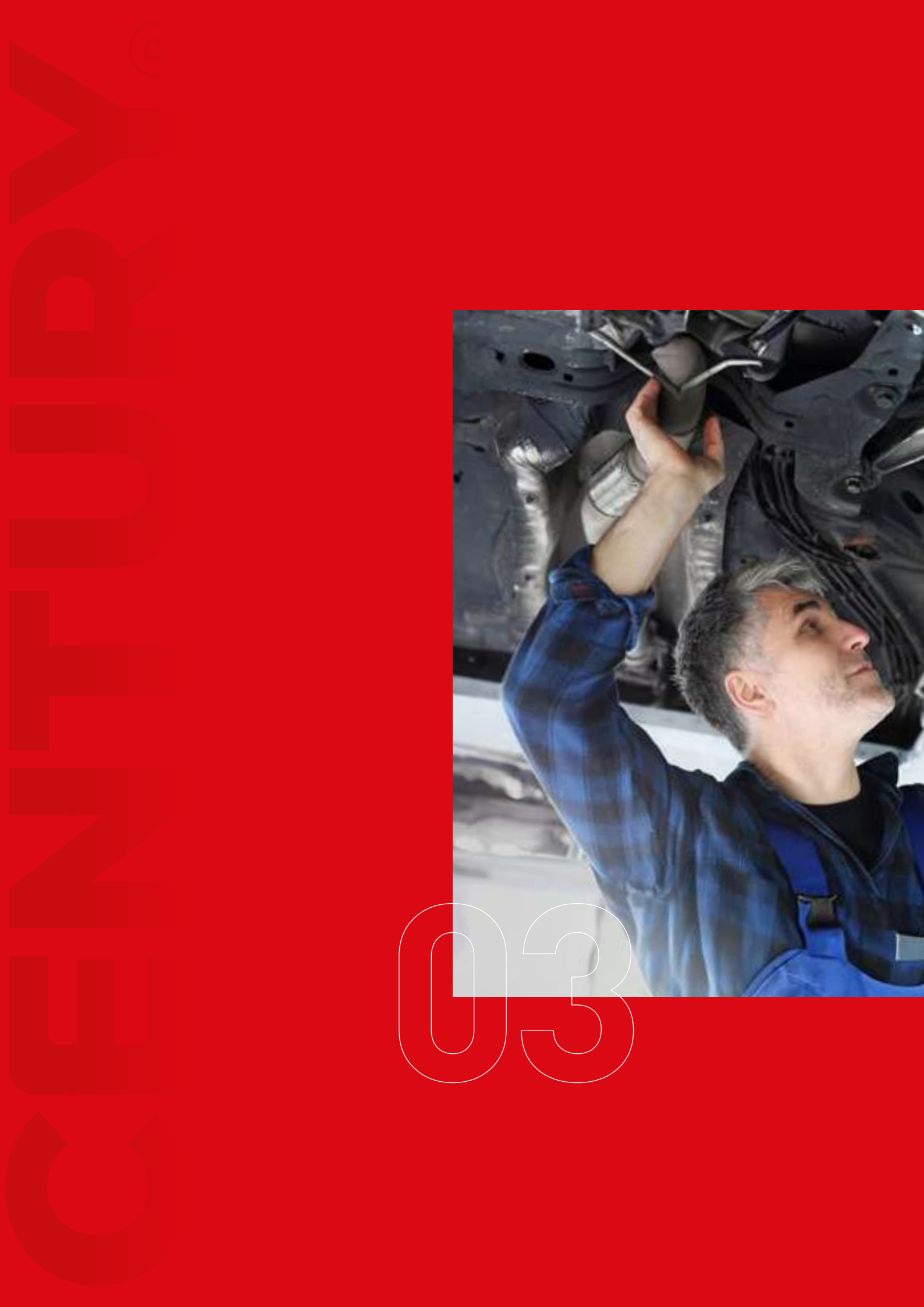

03



VERSATILI
 VERSATILI
 VERSATILI



BIOGIARDINO
 GIARDINETTO



PROIETTORI PORTATILI
 MINI WORK
 FUNNY
 PENNY
 SALLY



STRIP
 STRISCIA LED SENSOR
 STRISCIA LED USB



MINI LAMPADE
 MOUSE
 TOMMY
 ITALO
 NEMO
 SOLIDEA



LAMPADE PORTATILI
 COMODA EMERGENCY
 COMODA SOLAR



SEGNALATORI STRADALI
 BORCHIA SOLARE
 RIFLETTORE

SORGENTI

GO SMART

VERSATILI

INDOOR

OUTDOOR

SOLARI

WORK

PROFESSIONAL

ESPOSITORI

BIOGIARDINO
GIARDINETTO



LA SOLUZIONE PER COLTIVARE LE TUE PIANTE ALL'INTERNO, IN QUALSIASI MOMENTO DELL'ANNO.
 INDOOR SOLUTION FOR PLANTS GROWING ALL YEAR LONG.

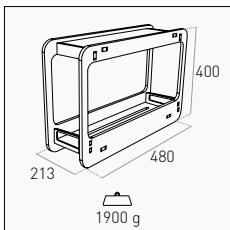

14 W	4000 K	GRD-144840	1/10	72,00 €
220-240 V	IP20		16 h ON	8 h OFF
			AUTOMATIC	

INCLUDED



PRESA 220 V/AC CON INTERRUTTORE
 220 V/AC SOCKET WITH SWITCH

FLOOR DISPLAY



KIT-EX-2RIP-GRD 1/1

TECHNICAL NOTES

FACILE DA ASSEMBLARE
 EASY TO ASSEMBLE

LED = BASSI CONSUMI ENERGETICI
 LED = LOW ENERGY CONSUMPTION

IDEALE PER FIORI, ERBE AROMATICHE ED ORTAGGI
 IDEAL FOR FLOWERS, AROMATIC HERBS AND VEGETABLES



STIMOLA LA FOTOSINTESI DELLE PIANTE
 PLANT PHOTOSYNTHESIS BOOST

1.573 MMOL/J

PROIETTORI PORTATILI

WORK



175 x 32 mm - 316 g

MINI WORK



10 W	700 lm (100%) - 350 lm (50%)	6 x 1,5 V AAA	4000K	MW-108040	1/20	29,00 €
------	------------------------------	---------------	-------	------------------	------	---------

IP44	90°	~10 h (6 BATT.) WORKING TIME 100%	~20 h (3 BATT.) WORKING TIME 50%	NOT INCLUDED	ABS
------	-----	--------------------------------------	-------------------------------------	--------------	-----



60 x 96 x 36 mm - 80 g

FUNNY



2 W	110 lm	3 x 1,5 V AAA	4000 K	FNY-020040	12/48	8,90 €
-----	--------	---------------	--------	-------------------	-------	--------

IP44	110°	~10 h WORKING TIME	NOT INCLUDED	MAGNETIC	ABS
------	------	-----------------------	--------------	----------	-----

INCLUDED



GANCIO ORIENTABILE, DOPPIO SPOT LUCE E MAGNETE
SWIVEL HOOK, DOUBLE LIGHT SPOT AND MAGNET



15 x 160 x 32 mm - 32 g

PENNY



3 W	200 lm	3 x 1,5 V AAA	4000 K	PNY-030040	12/48	8,90 €
-----	--------	---------------	--------	-------------------	-------	--------

IP44	120°	~10 h WORKING TIME	NOT INCLUDED	ABS
------	------	-----------------------	--------------	-----

INCLUDED

GANCIO ORIENTABILE SWIVEL HOOK



56 x 214 x 47 mm - 160 g

SALLY



3 W	130 lm	3 x 1,5 V AAA	4000 K	SLY-030040	12/48	15,50 €
-----	--------	---------------	--------	-------------------	-------	---------

IP44	120°	~10 h WORKING TIME	NOT INCLUDED	MAGNETIC	ABS
------	------	-----------------------	--------------	----------	-----

INCLUDED



GANCIO ORIENTABILE, DOPPIO SPOT LUCE E DOPPIO MAGNETE
SWIVEL HOOK, DOUBLE LIGHT SPOT AND DOUBLE MAGNET

E' possibile collocarli ovunque perché non necessitano di rete elettrica. Funzionano con batterie AAA (non incluse).

Placeable everywhere: no electrical network required. Workable with AAA batteries (not included).

STRIP
STRISCIA LED SENSOR

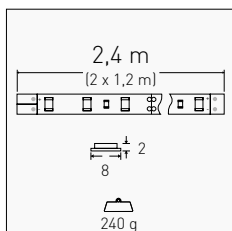

7 W (2,9 W/m)	540 lm (225 lm/m)	3000 K	KIT-SENSOR	10/20	45,00 €
220-240 V	IP20	120°	INDOOR	2 x 1,2 METERS	30 LED/m
					30 sec - 6 min ADJUSTABLE TIMER
					PIR SENSOR LIGHT SENSOR

FOCUS

INCLUDED



2 BOBINE DA 1,2 METRI, 2 SENSORI, DRIVER 230 V/AC, SPLITTER E CLIP DI FISSAGGIO
 2 X 1.2M REELS, 2 SENSORS, 230V/AC DRIVER, SPLITTER AND FIXING CLIP

INSTALLATION

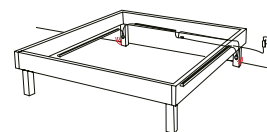

PERFETTA COME LUCE NOTTURNA POSIZIONATA SOTTO IL LETTO
 PERFECT AS A NIGHT LIGHT PLACED UNDER THE BED

TECHNICAL NOTES

ACCENSIONE AUTOMATICA NOTTURNA AL RILEVAMENTO DI MOVIMENTO CON TIMER REGOLABILE 30 SEC - 6 MIN
 AUTOMATIC SWITCH AT NIGHT UPON MOTION DETECTION WITH 30 SEC - 6 MIN ADJUSTABLE TIMER



IN VENDITA CON ESPOSITORE DA 10 PZ
 10 PCS DISPLAY READY FOR SALE

Kit pronto all'uso completo di 2 strisce, 2 sensori e alimentatore. Ideale per illuminare letti, cabine armadio o mobili.

Ready-to-use kit complete with 2 strips, 2 sensors and power supply. Ideal for beds, walk-in closets or furniture.

STRIP

STRISCIA LED USB 55"-75"



SORGENTI

GO SMART

VERSATILI

INDOOR

OUTDOOR

SOLARI

WORK

PROFESSIONAL

ESPOSITORI

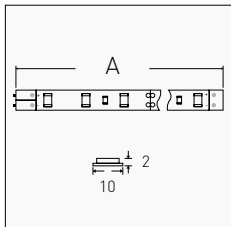

		A						
3 W (1,5 W/m)	43"-55"	2 m (4x50 cm)	66 g	RGB	KIT-TV55	20/40	25,00 €	
4 W (1,3 W/m)	55"-75"	3 m (2x50 cm + 1x1 m)	77 g	RGB	KIT-TV75	20/40	30,00 €	
◆ 5 V	≡ IP20	120°	INDOOR		30 LED/m	USB	DIMMABLE	EASY TO INSTALL

INCLUDED

TELECOMANDO MULTIFUNZIONE
MULTIFUNCTION REMOTE CONTROL

FOCUS

3M 300LSE
EXTRA STRONG
Facile installazione
Easy installation

INSTALLATION



IN VENDITA CON ESPOSITORE DA 20 PZ
20 PCS DISPLAY READY FOR SALE

Strip LED RGB in kit pronto all'uso per illuminare facilmente TV e monitor grazie all'alimentazione con USB.

Ready-to-use RGB LED strip kit for easy lighting of TVs and monitors thanks to USB power supply.



RAPIDA INSTALLAZIONE GRAZIE ALL' ALIMENTAZIONE TRAMITE USB
QUICK INSTALLATION THANKS TO USB POWER SUPPLY

MINI LAMPADE
VERSATILI



52 x 113 x 58 mm - 47 g



MOUSE

0,6 W	50 lm	4000 K	MS-066040	10/50	6,70 €
-------	-------	--------	------------------	-------	--------

□ 220-240 V IP20 120°

LIGHT SENSOR AUTOMATIC



66 x 100 x 73 mm - 42 g



TOMMY

0,6 W	30 lm	4000 K	TMY-062540	10/50	6,70 €
-------	-------	--------	-------------------	-------	--------

□ 220-240 V IP20 120°

LIGHT SENSOR AUTOMATIC



114 x 76 x 20 mm - 70 g



ITALO

3 W	200 lm	4 x 1,5 V AAA	4000 K	ITO-030040	12/24	8,90 €
-----	--------	---------------	--------	-------------------	-------	--------

◆ IP20 120° ~10 h WORKING TIME

NOT INCLUDED MAGNETIC

INCLUDED



ADESIVO 3M E MAGNETE
3M ADHESIVE AND MAGNET

Lampade versatili, compatte e dall'elevata praticità, creano una buona illuminazione generale, ideali per cabine armadio, pensili, ripostigli e dispense.

Versatile, compact and highly practical lamps, they create good general lighting, ideal for walk-in closets, wall units, closets and pantries.

MINI LAMPADE
VERSATILI



81 x 78 x 20 mm - 115 g



NEMO		🔋🔋🔋🔋						
3 W	120 lm	4 x 1,5 V AAA	4000 K	NE-030040	12/24	11,30 €		
⚡ IP20	120°	~10 h	WORKING TIME	🔋🔋🔋🔋	🔗	NOT INCLUDED	MAGNETIC	
							INCLUDED	
							MAGNETE MAGNET	



220 x 56 x 31 mm - 197 g
90° - 3 m



SOLIDEA		🔋🔋🔋						
0,4 W	40 lm	3 x 1,5 V AAA	4000 K	SLDS-042240	6/24	16,00 €		
⚡ IP20	120°	~10 h	WORKING TIME	👤	25 sec	🔋🔋🔋	PIR SENSOR AUTOMATIC OFF NOT INCLUDED	
							TECHNICAL NOTES	
							SELETTORE MODALITÀ	
							MODE SELECTOR	
							SENSOR OFF ALWAYS ON	

Lampade versatili, compatte e dall'elevata praticità, creano una buona illuminazione generale, ideali per cabine armadio, pensili, ripostigli e dispense.

Versatile, compact and highly practical lamps, they create good general lighting, ideal for walk-in closets, wall units, closets and pantries.

LAMPADE PORTATILI
COMODA



105 x 157 x 50 mm - 166 g

EMERGENCY									
6 W	200 lm	Li-Ion 3,7 V/DC	1.500 mAh	6500 K	CMDEM-060065	10/40		16,00 €	
IP20	~4-6 h	~3 h							
	WORKING TIME	RECHARGE		EMERGENCY	POWERBANK	RECHARGEABLE	NOT INCLUDED	ABS	

EMERGENCY MODE

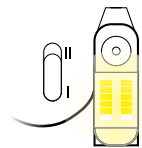

CON INTERRUTTORE IMPOSTATO SU I, MENTRE È IN CARICA, LA TORCIA RESTA SPENTA PER ACCENDERSI IN CASO DI BLACKOUT.
WITH THE SWITCH SET TO I, WHILE IT IS CHARGING, THE FLASHLIGHT REMAINS OFF AND THEN TURNS ON IN CASE OF A BLACKOUT.

OPERATING MODE

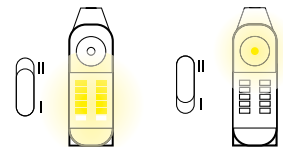

DOPPIA MODALITÀ LUMINOSA
DOUBLE LIGHT MODE



Pannello fotovoltaico
Photovoltaic panel

Ø51 x 174 x 47 mm - 166 g

SOLAR									
5 W		Lead 4 V/DC	1.000 mAh	6500 K	CMDSOL-050065	10/40		13,50 €	
IP20	~4-6 h	~3 h (USB)							
	WORKING TIME	RECHARGE		MONOCRYSTALLINE	RECHARGEABLE	ABS			

OPERATING MODE

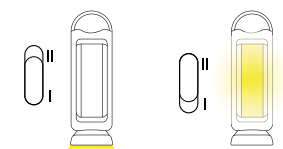

DOPPIA MODALITÀ LUMINOSA
DOUBLE LIGHT MODE

Mini torce LED portatili, ricaricabili con cavo micro USB (incluso). Corpo in materiale plastico antiurto.

Portable mini LED flashlight, rechargeable with micro USB cable (included). Shockproof plastic material body.

SEGNALATORE STRADALE

BORCHIA SOLARE



103 x 106 mm - 286 g

2.5 V / 0.2 W	Ni-MH 1.2 V/DC 800 mAh	4000 K	BSS-024000	1/40	32,00 €	
IP68 	~100 h WORKING TIME					
			FLASH MODE	LIGHT SENSOR	MONOCRYSTALLINE	ALUMINUM

Segnalatore stradale in alluminio, ricaricabile tramite il pannello fotovoltaico incluso. Autonomia fino a 100 ore. Fori per fissaggio a terra.
Aluminum road indicator, rechargeable via photovoltaic panel included. Autonomy up to 100 hours. Holes for ground fixing.

SEGNALATORE STRADALE

RIFLETTORE



103 x 103 mm - 181 g

Catarifrangente Reflector	Orange	RFL100	1/40	5,00 €	
					REFLECTOR ABS

Segnalatore catarifrangente in ABS. Finitura arancione per maggiore visibilità. Fondo sabbato per maggiore aderenza.
ABS Reflector. Orange finish for greater visibility. Sandblasted bottom for greater grip.

SORGENTI

GO SMART

VERSATILI

INDOOR

OUTDOOR

SOLARI

WORK

PROFESSIONAL

ESPOSITORI



04



INDOOR
INDOOR
INDOOR

SORGENTI

GO SMART

VERSATILI

INDOOR

OUTDOOR

SOLARI

WORK

PROFESSIONAL

ESPOSITORI



PLAFONIERE

NEW BLANCA LUXE
BLANCA PERLA
BLANCA SLIM
PL-TONDO
PL-QUADRO



INCASSO

P-TONDO
P-QUADRO
SPOTFIVE
ELIO
FUTURA

SUPPORTI

KLAK
KLIK



GESSI

JESSY APPLIQUE
JESSY INCASSO



DECORATIVO

ENFASI STYLO
ENFASI SQUARE
ENFASI ROUND
ESSENZA QUBE
ESSENZA RONDÒ
ESSENZA ORIENTABILE



SOSPENSIONI

FANTASY
FUSION 150



NEW

PLAFONIERA DECORATIVA
BLANCA LUXE

NEW

PLAFONIERA DECORATIVA

BLANCA LUXE

TRICOLOR
3000K
4000K
6500K

TRICOLOR

Ø 30 CM

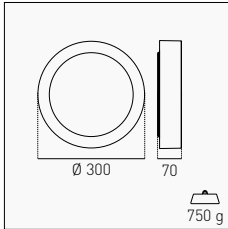

SOURCE	OUTPUT	FINISH		
17 W	2.200 lm	1.600 lm	White <input type="checkbox"/> 3000 - 4000 - 6500 K	BCL-1730BI NEW
			Corten <input type="checkbox"/> 3000 - 4000 - 6500 K	BCL-1730CO NEW
			Grey <input type="checkbox"/> 3000 - 4000 - 6500 K	BCL-1730GR NEW
			Black <input type="checkbox"/> 3000 - 4000 - 6500 K	BCL-1730NE NEW
			Sand <input type="checkbox"/> 3000 - 4000 - 6500 K	BCL-1730SA NEW
			Green <input type="checkbox"/> 3000 - 4000 - 6500 K	BCL-1730VE NEW
			1/5	49,00 €

220-240 V IP20 120°

 PC RING ABS DIFFUSER SPCC BODY CCT TRICOLOR

Ø 40 CM

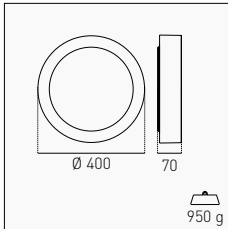

SOURCE	OUTPUT	FINISH		
24 W	2.700 lm	2.250 lm	White <input type="checkbox"/> 3000 - 4000 - 6500 K	BCL-2440BI NEW
			Corten <input type="checkbox"/> 3000 - 4000 - 6500 K	BCL-2440CO NEW
			Grey <input type="checkbox"/> 3000 - 4000 - 6500 K	BCL-2440GR NEW
			Black <input type="checkbox"/> 3000 - 4000 - 6500 K	BCL-2440NE NEW
			Sand <input type="checkbox"/> 3000 - 4000 - 6500 K	BCL-2440SA NEW
			Green <input type="checkbox"/> 3000 - 4000 - 6500 K	BCL-2440VE NEW
			1/5	69,00 €

220-240 V IP20 120°

 PC RING ABS DIFFUSER SPCC BODY CCT TRICOLOR

INSTALLATION



PERFETTA PER INSTALLAZIONI A PARETE O SOFFITTO
PERFECT FOR WALL OR CEILING INSTALLATIONS

TECHNICAL NOTES



LUCE PERIMETRALE DECORATIVA CHE CONTORNA LA PLAFONIERA,
GARANTENDO UN EFFETTO VISIVO ELEGANTE E MODERNO
DECORATIVE PERIMETER LIGHT AROUND THE CEILING LIGHT,
TO REACH AN ELEGANT AND MODERN VISUAL EFFECT

FOCUS

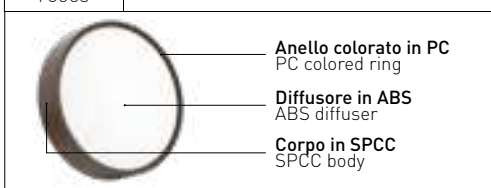

Plafoniera LED decorativa che unisce funzionalità ed eleganza. Ideale per qualsiasi ambiente interno, offre un'illuminazione uniforme e brillante. Il diffusore in ABS di alta qualità assicura una luce omogenea e priva di abbagliamento nella parte frontale ed un'elegante luce perimetrale sul retro. L'anello colorato, infine, aggiunge un tocco di stile distintivo, valorizzando ogni spazio con il suo design moderno.

Decorative LED ceiling light that combines functionality and elegance. Ideal for any interior environment, it offers uniform and bright lighting. The high-quality ABS diffuser ensures uniform and glare-free light on the front and an elegant perimeter light on the back. Finally, the colored ring adds a touch of distinctive style, enhancing any space with its modern design.



REGOLAZIONE DEL COLORE LUCE TRAMITE SELETTORE
COLOR TEMPERATURE ADJUSTMENT THROUGH SWITCH

PLAFONIERA
BLANCA PERLA



	A mm	B mm	g
14 W	Ø 265	100	297
20 W	Ø 290	100	406
24 W	Ø 345	100	520
32 W	Ø 375	110	700

	SOURCE		OUTPUT				
14 W	1.380 lm	1.100 lm	4000 K		BCP-122840	1/6	29,50 €
20 W	2.050 lm	1.520 lm	4000 K		BCP-183340	1/6	34,50 €
24 W	2.500 lm	1.800 lm	4000 K		BCP-243840	1/6	42,00 €
32 W	3.380 lm	2.240 lm	4000 K		BCP-323840	1/6	47,00 €

220-240 V
 IP20
 180°

PEARL WHITE
 PC



INSTALLATION



PERFETTA PER INSTALLAZIONI A PARETE O SOFFITTO
 PERFECT FOR WALL OR CEILING INSTALLATIONS

Plafoniera LED dal design moderno e finitura bianca perlata. Garantisce un flusso luminoso brillante ed uniforme. Adatta per l'illuminazione generale delle stanze, scale, ingressi e corridoi per un'illuminazione diffusa.

LED ceiling lamp with a modern design and pearly white finish. It guarantees a bright and uniform luminous flux. Suitable for general lighting of rooms, stairs, entrances and corridors for diffused lighting.

PLAFONIERA
BLANCA SLIM



	A mm	B mm	g
14 W	Ø 245	55	259
20 W	Ø 330	65	364
24 W	Ø 375	70	487
32 W	Ø 390	65	615

SOURCE		OUTPUT				
14 W	1.550 lm	1.090 lm	3000 K	BCS-142530	1/10	17,25 €
			4000 K	BCS-142540		
20 W	2.200 lm	1.550 lm	3000 K	BCS-203030	1/10	22,50 €
			4000 K	BCS-203040		
24 W	2.800 lm	1.800 lm	3000 K	BCS-243530	1/10	29,50 €
			4000 K	BCS-243540		
32 W	3.380 lm	2.750 lm	3000 K	BCS-323930	1/10	39,50 €
			4000 K	BCS-323940		

220-240 V IP20 120°

WHITE ULTRASLIM PMMA

Plafoniera LED dal design sottile, adatta a tutti gli ambienti interni. Il diffusore in PMMA di elevata qualità garantisce un flusso luminoso brillante ed uniforme.

LED ceiling lamp with a slim design, suitable for all indoor environments. The high quality PMMA diffuser guarantees a bright and uniform luminous flux.

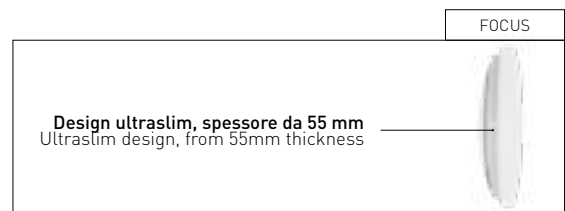

PLAFONIERA
PL-TONDO



ROUND

	A mm	 g
18 W	Ø225	408
24 W	Ø300	672

SOURCE		OUTPUT				
18 W	1.800 lm	1.440 lm	3000 K	PTP-182230	6/24	28,50 €
			4000 K	PTP-182240		
24 W	2.350 lm	1.920 lm	3000 K	PTP-243030	6/12	34,50 €
			4000 K	PTP-243040		

220-240 V IP20 120°

ALUMINUM OPAL PMMA FLICKER-FREE DRIVER INCL.

OPTIONAL

RICAMBIO DRIVER
SPARE DRIVER

INPUT		OUTPUT				
18 W	300 mA	220-240 V/AC	54 V/DC	RDPQ18	1/100	10,00 €
24 W	600 mA	220-240 V/AC	36 V/DC	RDPQ24	1/100	11,00 €

IP20 NOT DIMMABLE

Pannello circolare con montaggio a plafone dal design elegante. Driver antisfarfallio incluso.

Circular ceiling-mounted panels with an elegant design. Flicker-free driver included.

PLAFONIERA
PL-QUADRO



SORGENTI

GO SMART

VERSATILI

INDOOR

OUTDOOR

SOLARI

WORK

PROFESSIONAL

ESPOSITORI

SQUARE

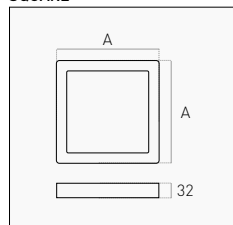

	A mm	g
18 W	225	519
24 W	300	827

	SOURCE	OUTPUT			
18 W	1.800 lm	1.440 lm	3000 K	PQP-182230	6/24
			4000 K	PQP-182240	
24 W	2.350 lm	1.920 lm	3000 K	PQP-243030	6/12
			4000 K	PQP-243040	

220-240 V IP20 120°

ALUMINUM OPAL PMMA FLICKER-FREE DRIVER INCL.

OPTIONAL

RICAMBIO DRIVER
SPARE DRIVER

	INPUT		OUTPUT			
18 W	300 mA	220-240 V/AC	54 V/DC	RDPQ18	1/100	10,00 €
24 W	600 mA	220-240 V/AC	36 V/DC	RDPQ24	1/100	11,00 €

IP20 NOT DIMMABLE

Pannello quadrato con montaggio a plafone dal design elegante. Driver antisfarfallio incluso.

Square ceiling-mounted panels with an elegant design. Flicker-free driver included.

PANNELLI
P-TONDO



P-TONDO

	A mm	mm	g
3 W	Ø85	Ø70	112
6 W	Ø117	Ø105	142
9 W	Ø147	Ø130	181
12 W	Ø170	Ø155	236
18 W	Ø225	Ø205	373
24 W	Ø300	Ø280	532

	SOURCE		OUTPUT			
3 W	260 lm	180 lm	3000 K	PT-038530	6/24	9,50 €
			4000 K	PT-038540		
6 W	550 lm	400 lm	3000 K	PT-061230	6/24	12,50 €
			4000 K	PT-061240		
9 W	780 lm	600 lm	3000 K	PT-091430	6/24	14,50 €
			4000 K	PT-091440		
12 W	1.100 lm	960 lm	3000 K	PT-121730	6/24	16,00 €
			4000 K	PT-121740		
18 W	1.800 lm	1.440 lm	3000 K	PT-182230	6/24	21,25 €
			4000 K	PT-182240		
24 W	2.350 lm	1.920 lm	3000 K	PT-243030	6/12	31,00 €
			4000 K	PT-243040		

220-240 V IP20 120°

ALUMINUM OPAL PMMA ULTRASLIM DRIVER INCL.

Ottica antiabbaglio, alimentatore esterno in dotazione, assenza di raggi UV e IR. Design elegante ultrasottile.

Anti-glare optics, external power supply included, UV and IR rays free. Ultra-thin elegant design.

OPTIONAL PAG. 192

RICAMBIO DRIVER
SPARE DRIVER

PANNELLI
P-QUADRO



P-QUADRO

	A mm	∇ mm	∇ g
3 W	85	65x65	112
6 W	120	100x100	157
9 W	145	130x130	244
12 W	172	155x155	280
18 W	225	205x205	455
24 W	300	280x280	550

	SOURCE	OUTPUT				
3 W	260 lm	180 lm	3000 K	PQ-038530	6/24	11,00 €
			4000 K	PQ-038540		
6 W	550 lm	400 lm	3000 K	PQ-061230	6/24	13,50 €
			4000 K	PQ-061240		
9 W	780 lm	600 lm	3000 K	PQ-091430	6/24	16,00 €
			4000 K	PQ-091440		
12 W	1.100 lm	960 lm	3000 K	PQ-121730	6/24	18,50 €
			4000 K	PQ-121740		
18 W	1.800 lm	1.440 lm	3000 K	PQ-182230	6/24	21,25 €
			4000 K	PQ-182240		
24 W	2.350 lm	1.920 lm	3000 K	PQ-243030	6/12	33,00 €
			4000 K	PQ-243040		

220-240 V IP20 120°

ALUMINUM OPAL PMMA ULTRASLIM DRIVER INCL.

Ottica antiabbaglio, alimentatore esterno in dotazione, assenza di raggi UV e IR. Design elegante ultrasottile.

Anti-glare optics, external power supply included, UV and IR rays free. Ultra-thin elegant design.

OPTIONAL PAG. 192

RICAMBIO DRIVER
SPARE DRIVER



DOWNLIGHT SPOTFIVE

TRICOLOR
3000K
4000K
6500K



	A mm	B mm	Ø mm	g
9 W	Ø113	59	Ø92	130
14 W	Ø145	66	Ø130	185
17 W	Ø174	69	Ø150	252
25 W	Ø244	85	Ø205	381

	SOURCE		OUTPUT				
9 W	960 lm	800 lm	3000 - 4000 - 6500 K		SPF-091100	10/40	19,50 €
14 W	1.510 lm	1.260 lm	3000 - 4000 - 6500 K		SPF-141400	10/40	27,50 €
17 W	1.600 lm	1.550 lm	3000 - 4000 - 6500 K		SPF-171700	10/40	36,00 €
25 W	2.900 lm	2.450 lm	3000 - 4000 - 6500 K		SPF-252400	10/20	49,00 €

220-240 V IP20 ↓ IP44 ↑ IK04 120° DIMMABLE ALUMINUM 40.000 h DRIVER INCL. CCT TRICOLOR

SORGENTI

GO SMART

VERSATILI

INDOOR

OUTDOOR

SOLARI

WORK

PROFESSIONAL

ESPOSITORI



TECHNICAL NOTES



DIMMERABILE CON SISTEMI A TAGLIO DI FASE
DIMMABLE WITH TRAILING-EDGE SYSTEMS

Downlight dimmerabile con sistemi trailing-edge o Led Dimmer e con selettore CCT per la regolazione del colore luce.

Dimmable downlight with trailing-edge or Led Dimmer systems and with CCT selector for adjusting the color temperature.



REGOLAZIONE DEL COLORE LUCE TRAMITE SELETTORE SUL RETRO
COLOR TEMPERATURE ADJUSTMENT THROUGH SELECTOR ON THE BACK

DOWNLIGHT
ELIO



	A mm	mm	g
6 W	Ø 101	Ø 72	40
9 W	Ø 116	Ø 87	55
12 W	Ø 132	Ø 105	70
15 W	Ø 151	Ø 122	95
18 W	Ø 176	Ø 147	120
24 W	Ø 201	Ø 172	215

	SOURCE	OUTPUT				
6 W	540 lm	390 lm	3000 K	ELO-060730	1/20	5,50 €
			4000 K	ELO-060740		
9 W	820 lm	580 lm	3000 K	ELO-090930	1/20	6,50 €
			4000 K	ELO-090940		
12 W	1.160 lm	840 lm	3000 K	ELO-121130	1/20	7,50 €
			4000 K	ELO-121140		
15 W	1.490 lm	1.080 lm	3000 K	ELO-151230	1/20	9,50 €
			4000 K	ELO-151240		
18 W	1.830 lm	1.260 lm	3000 K	ELO-181530	1/20	12,80 €
			4000 K	ELO-181540		
24 W	2.490 lm	1.730 lm	3000 K	ELO-241730	1/20	15,50 €
			4000 K	ELO-241740		

220-240 V
 IP20
 100°

PC DIFFUSER
 ALUMINUM

Pannello a incasso LED. Illuminazione diffusa e omogenea, diffusore in PC, corpo in PP. Per uso interno.

Recessed LED panel. Diffused and homogeneous lighting, diffuser in PC, body in PP. For indoor use.

DOWNLIGHT
FUTURA

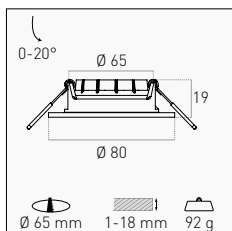

	OUTPUT 360°	OUTPUT 90°				
5 W	520 lm	480 lm	3000 K	FT-066830	1/40	11,00 €
			4000 K	FT-066840		
		220-240 V	IP20	41°	0-20°	ADJUSTABLE ALUMINUM DRIVER INCL.

TECHNICAL NOTES



TESTA ORIENTABILE 0-20° PER DIREZIONARE IL FASCIO LUMINOSO
ADJUSTABLE HEAD 0-20° TO DIRECT THE LIGHT BEAM

Downlight SUPERSLIM da 19 mm di spessore, consente installazioni in controsoffitti anche con minimo spazio. Testa orientabile.

SUPERSLIM downlight only 19 mm thick, it can be installed in false ceiling even with limited space. Adjustable head.



KLRXL-NE



KLRFX-BI



KLRFX-BN



KLRCOON-BI



KLR-CR



KLSCON-NE



KLS-BI

INCASSO - SUPPORTI
KLAK



ORIENTABILE ADJUSTABLE

Round	
White <input type="checkbox"/>	Black <input checked="" type="checkbox"/>
KLRXL-BI	KLRXL-NE
10/50	
12,50 €	

IP20 0-30° 5
 ADJUSTABLE ALUMINUM YEARS

FISSO FIXED

Round	
White <input type="checkbox"/>	Black <input checked="" type="checkbox"/>
KLRFX-BI	KLRFX-NE
10/50	
14,75 €	

IP20 5
 ALUMINUM YEARS

FISSO FIXED

Round	
White <input type="checkbox"/> + Black <input checked="" type="checkbox"/>	
KLRFX-BN	
10/50	
12,50 €	

IP20 5
 ALUMINUM YEARS

ORIENTABILE ADJUSTABLE

Round	
White <input type="checkbox"/>	Black <input checked="" type="checkbox"/>
KLRCON-BI	KLRCON-NE
10/50	
12,50 €	

IP20 0-30° 5
 ADJUSTABLE ALUMINUM YEARS

ORIENTABILE ADJUSTABLE

Round		
Silver <input checked="" type="checkbox"/>	White <input type="checkbox"/>	Cromo <input checked="" type="checkbox"/>
KLR-AR	KLR-BI	KLR-CR
10/50	10/50	10/50
9,75 €	8,75 €	9,75 €

IP20 0-60° 5
 ADJUSTABLE ALUMINUM YEARS

ORIENTABILE ADJUSTABLE

Square	
White <input type="checkbox"/>	Black <input checked="" type="checkbox"/>
KLSCON-BI	KLSCON-NE
10/50	
12,50 €	

IP20 0-30° 5
 ADJUSTABLE ALUMINUM YEARS

ORIENTABILE ADJUSTABLE

Square		
Silver <input checked="" type="checkbox"/>	White <input type="checkbox"/>	Cromo <input checked="" type="checkbox"/>
KLS-AR	KLS-BI	KLS-CR
10/50	10/50	10/50
9,75 €	8,75 €	9,75 €

IP20 0-60° 5
 ADJUSTABLE ALUMINUM YEARS



Eleganti supporti per lampade spot.
 Corpo in alluminio pressofuso.

Elegant supports for spot lamps.
 Die-cast aluminum body.

TECHNICAL NOTES



FACILE INSTALLAZIONE CON SISTEMA A SCATTO BREVETTATO
 EASY INSTALLATION WITH PATENTED CLICK SYSTEM

INCLUDED



ATTACCO GU10 CON BOX DI COLLEGAMENTO PROFESSIONALE
 GU10 SOCKET WITH PROFESSIONAL JUNCTION BOX

REQUIRED PAG. 36-39



LAMPADA SPOT GU10
 GU10 SPOT LAMP

SORGENTI

GO SMART

VERSATILI

INDOOR

OUTDOOR

SOLARI

WORK

PROFESSIONAL

ESPOSITORI

INCASSO - SUPPORTI

KLIK ROUND

PROFONDA DEEP

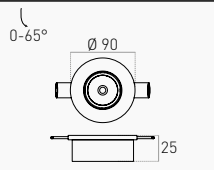



0-65°
Ø 90
25

Ø 75 mm 1-20 mm 39 g

White

KLIRL

10/50 

3,75 €

IP20 0-65°
⚡ ADJUSTABLE PC

SPIRALE SPIRAL

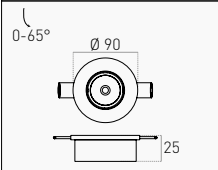



0-65°
Ø 90
25

Ø 75 mm 1-20 mm 39 g

White

KLIRM

10/50 

3,25 €

IP20 0-65°
⚡ ADJUSTABLE PC

SUPERFICIE SURFACE

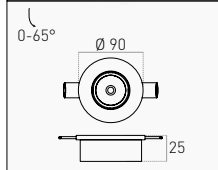



0-65°
Ø 90
25

Ø 75 mm 1-20 mm 39 g

White

KLIRS

10/50 

3,25 €

IP20 0-65°
⚡ ADJUSTABLE PC

A SCOMPARSA CONCEALED

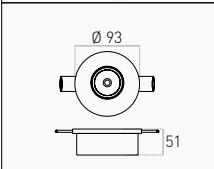



Ø 93
51

Ø 85 mm 1-20 mm 72 g

White

KLIRXL

10/50 

5,50 €

IP20 
⚡ PC

A SCOMPARSA DECENTRATA
CONCEALED DECENTRALIZED

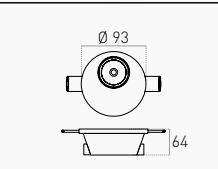



Ø 93
64

Ø 85 mm 1-20 mm 72 g

White

KLIRXLD

10/50 

5,50 €

IP20 
⚡ PC

OPTIONAL

 PORTALAMPADA
LAMP HOLDER

GU10	PLGU10	10 	1,25 €
GU5.3	PLGU53		

Faretti ad incasso orientabili in PC.
Montaggio lampada (non inclusa) a scatto.

Adjustable recessed spotlights in PC.
Snap-on lamp (not included) assembly.



REQUIRED PAG. 36-39

 LAMPADA SPOT GU10
GU10 SPOT LAMP

 LAMPADA SPOT GU5.3
GU5.3 SPOT LAMP

INCASSO - SUPPORTI
KLIK SQUARE

PROFONDA DEEP

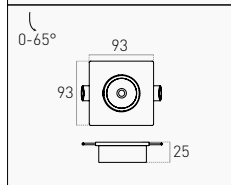
75x75 mm 1-20 mm 59 g

White

KLISL

10/50 

4,25 €

IP20 0-65° 
ADJUSTABLE PC

PROFONDA DOPPIA DOUBLE DEEP

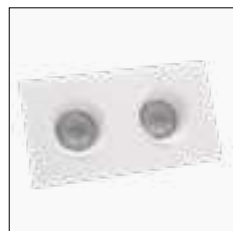
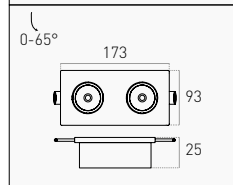
155x75 mm 1-20 mm 114 g

White

KLISL2

10/50 

8,00 €

IP20 0-65° 
ADJUSTABLE PC

SPIRALE SPIRAL

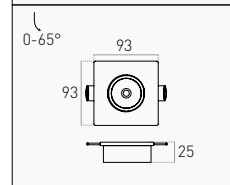
75x75 mm 1-20 mm 48 g

White

KLISM

10/50 

3,75 €

IP20 0-65° 
ADJUSTABLE PC

SPIRALE DOPPIA DOUBLE SPIRAL

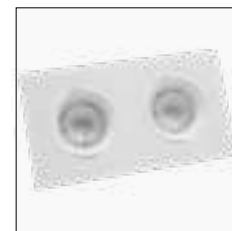
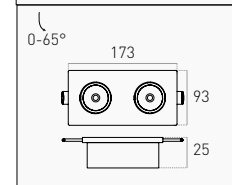
155x75 mm 1-20 mm 92 g

White

KLISM2

10/50 

7,25 €

IP20 0-65° 
ADJUSTABLE PC

SUPERFICIE SURFACE

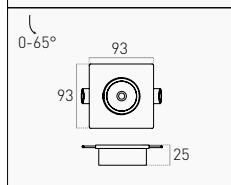
75x75 mm 1-20 mm 46 g

White

KLISS

10/50 

3,75 €

IP20 0-65° 
ADJUSTABLE PC

SUPERFICIE DOPPIA DOUBLE SURFACE

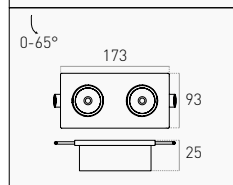
155x75 mm 1-20 mm 90 g

White

KLISS2

10/50 

7,25 €

IP20 0-65° 
ADJUSTABLE PC

A SCOMPARSA CONCEALED

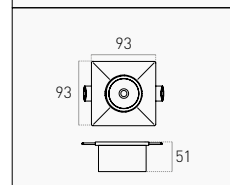
85x85 mm 1-20 mm 74 g

White

KLISXL

10/50 

5,50 €

IP20 
PC

**A SCOMPARSA DECENTRATA
CONCEALED DECENTRALIZED**

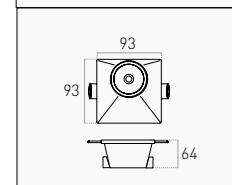
85x85 mm 1-20 mm 74 g

White

KLISXLD

10/50 

5,50 €

IP20 
PC

OPTIONAL

REQUIRED PAG. 36-39



LAMPADA SPOT GU10
GU10 SPOT LAMP

LAMPADA SPOT GU5.3
GU5.3 SPOT LAMP



PORTALAMPADA
LAMP HOLDER

GU10	PLGU10	10 	1,25 €
GU5.3	PLGU53		

Faretti ad incasso orientabili in PC.
Montaggio lampada (non inclusa) a scatto.

Adjustable recessed spotlights in PC.
Snap-on lamp (not included) assembly.



AP115



AP125



AP275



AP360

APPLIQUE - GESSO

JESSY

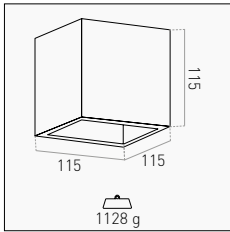

1 Slot G9 (40 W MAX)	White <input type="checkbox"/>	JESSY-AP115	1/18	34,75 €
220-240 V IP20	DOUBLE EMISSION	PAINTABLE	GESSO/PLASTER	3 YEARS

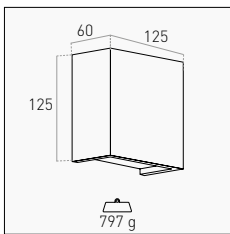
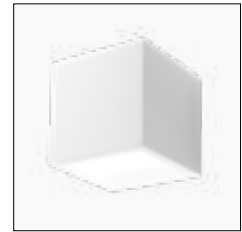

1 Slot G9 (40 W MAX)	White <input type="checkbox"/>	JESSY-AP125	1/12	34,75 €
220-240 V IP20	DOUBLE EMISSION	PAINTABLE	GESSO/PLASTER	3 YEARS

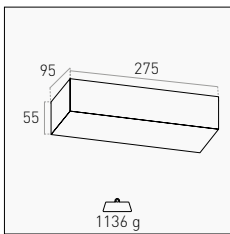

1 Slot E14 (40 W MAX)	White <input type="checkbox"/>	JESSY-AP275	1/12	39,75 €
220-240 V IP20	PAINTABLE	GESSO/PLASTER	3 YEARS	

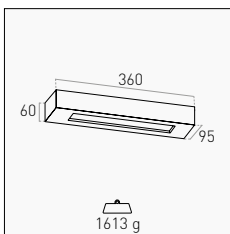
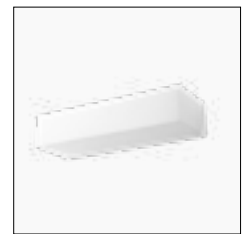

2 Slot E14 (40 W MAX)	White <input type="checkbox"/>	JESSY-AP360	1/12	52,50 €
220-240 V IP20	DOUBLE EMISSION	PAINTABLE	GESSO/PLASTER	3 YEARS

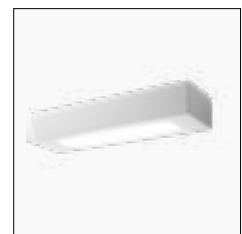

Eleganti applique in gesso per una luce diffusa sulla parete. Possono essere dipinte per integrarsi in ogni ambiente.

Elegant plaster wall light for a diffused light effect. Suitable to be painted for every ambients customization.



REQUIRED PAG. 26/41



LAMPADA G9
G9 LAMP



LAMPADA E14
E14 LAMP

SORGENTI

GO SMART

VERSATILI

INDOOR

OUTDOOR

SOLARI

WORK

PROFESSIONAL

ESPOSITORI



AP150



AP180



AP280

APPLIQUE - GESSO

JESSY

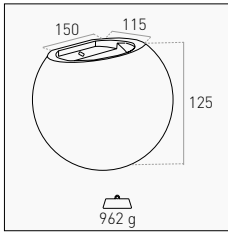

1 Slot G9 (40 W MAX)	White <input type="checkbox"/>	JESSY-AP150	1/12	36,25 €
220-240 V		DOUBLE EMISSION PAINTABLE GESSO/PLASTER 3 YEARS		

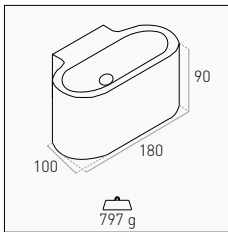
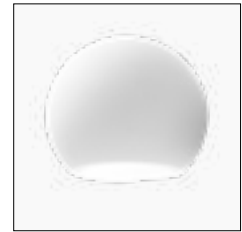

1 Slot G9 (40 W MAX)	White <input type="checkbox"/>	JESSY-AP180	1/9	36,25 €
220-240 V		DOUBLE EMISSION PAINTABLE GESSO/PLASTER 3 YEARS		

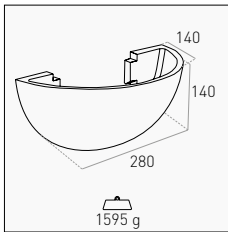

1 Slot E14 (40 W MAX)	White <input type="checkbox"/>	JESSY-AP280	1/12	39,75 €
220-240 V		PAINTABLE GESSO/PLASTER 3 YEARS		

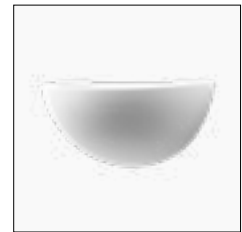

Eleganti applique in gesso per una luce diffusa sulla parete. Possono essere dipinte per integrarsi in ogni ambiente.

Elegant plaster wall light for a diffused light effect. Suitable to be painted for every ambients customization.



REQUIRED PAG. 26/41



SORSENTI

GO SMART

VERSATILI

INDOOR

OUTDOOR

SOLARI

WORK

PROFESSIONAL

ESPOSITORI

SQ100



SQ120



AR111



PORTAFARETTI - GESSO

JESSY SQUARE

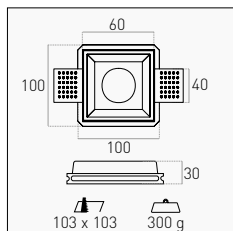

1 Slot \varnothing GU10 (35W MAX) White **JESSY-SQ100** 1/24 9,00 €

220-240 V IP20

PAINTABLE GESSO/PLASTER

INCLUDED

PORTALAMPADA GU10
GU10 LAMP HOLDER

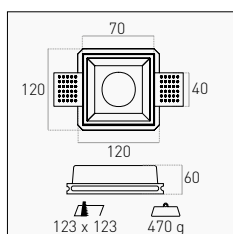
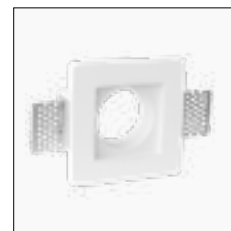

1 Slot \varnothing GU10 (35W MAX) White **JESSY-SQ120** 1/24 12,00 €

220-240 V IP20

PAINTABLE GESSO/PLASTER

INCLUDED

PORTALAMPADA GU10
GU10 LAMP HOLDER

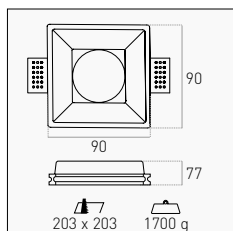
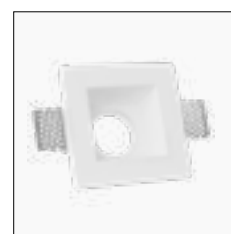

1 Slot \varnothing G53 (35W MAX) White **JESSY-AR111** 1/6 38,75 €

220-240 V IP20

PAINTABLE GESSO/PLASTER



INSTALLATION



REALIZZATO IN GESSO RESINATO VERNICIABILE PER INSTALLAZIONI A SCOMPARSA
MADE OF PAINTABLE RESIN-COATED PLASTER FOR CONCEALED INSTALLATIONS

REQUIRED PAG. 36-39/51

LAMPADA SPOT GU10
GU10 SPOT LAMPS

LAMPADA AR111
AR111 LAMP



Portafaretti da incasso in gesso adatti ad essere installati in ogni controsoffitto in maniera totalmente invisibile.

Plaster recessed spotlight holder suitable to be installed in any false ceiling in a totally invisible way.

SORGENTI

GO SMART

VERSATILI

INDOOR

OUTDOOR

SOLARI

WORK

PROFESSIONAL

ESPOSITORI

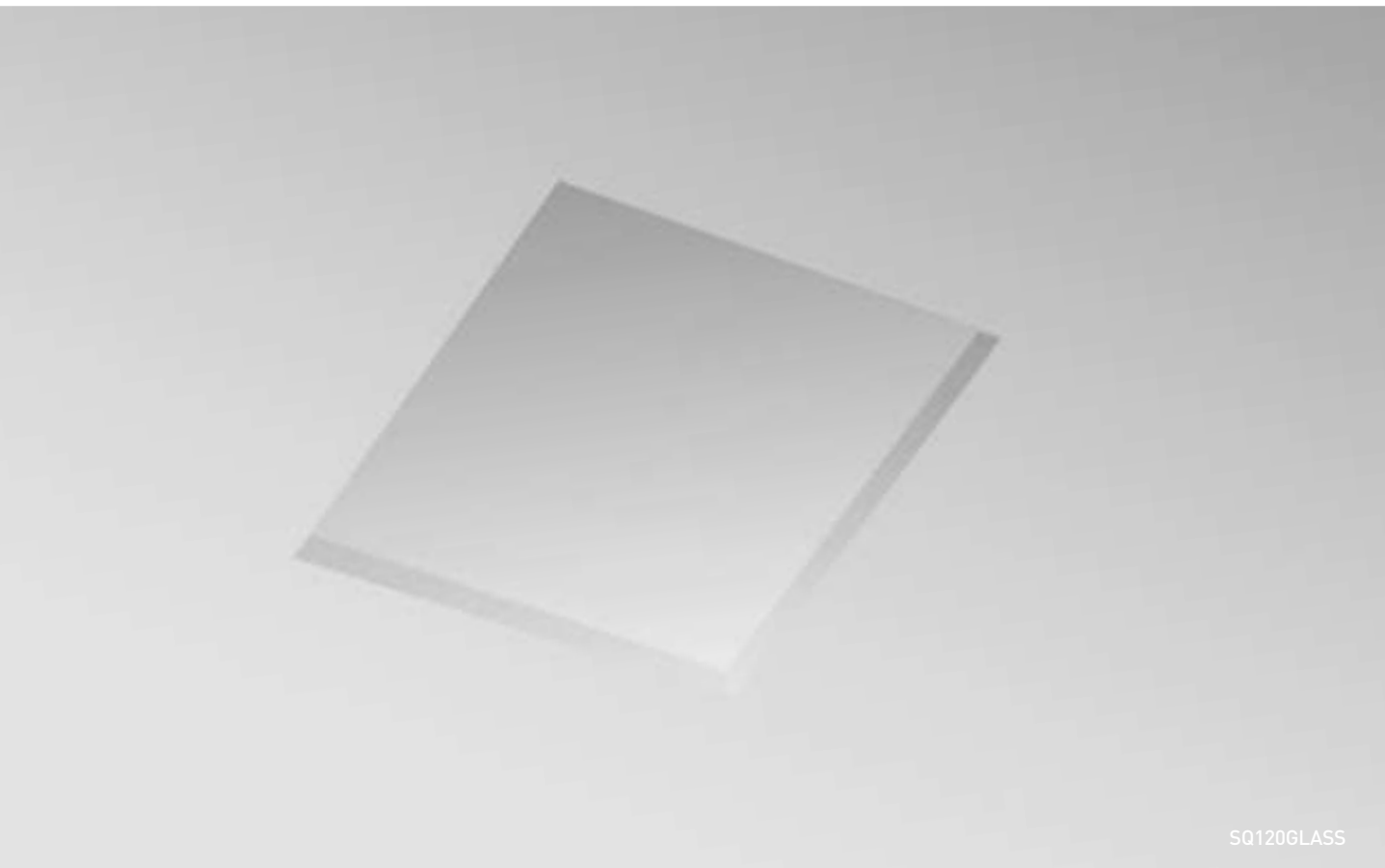

SQ120GLASS

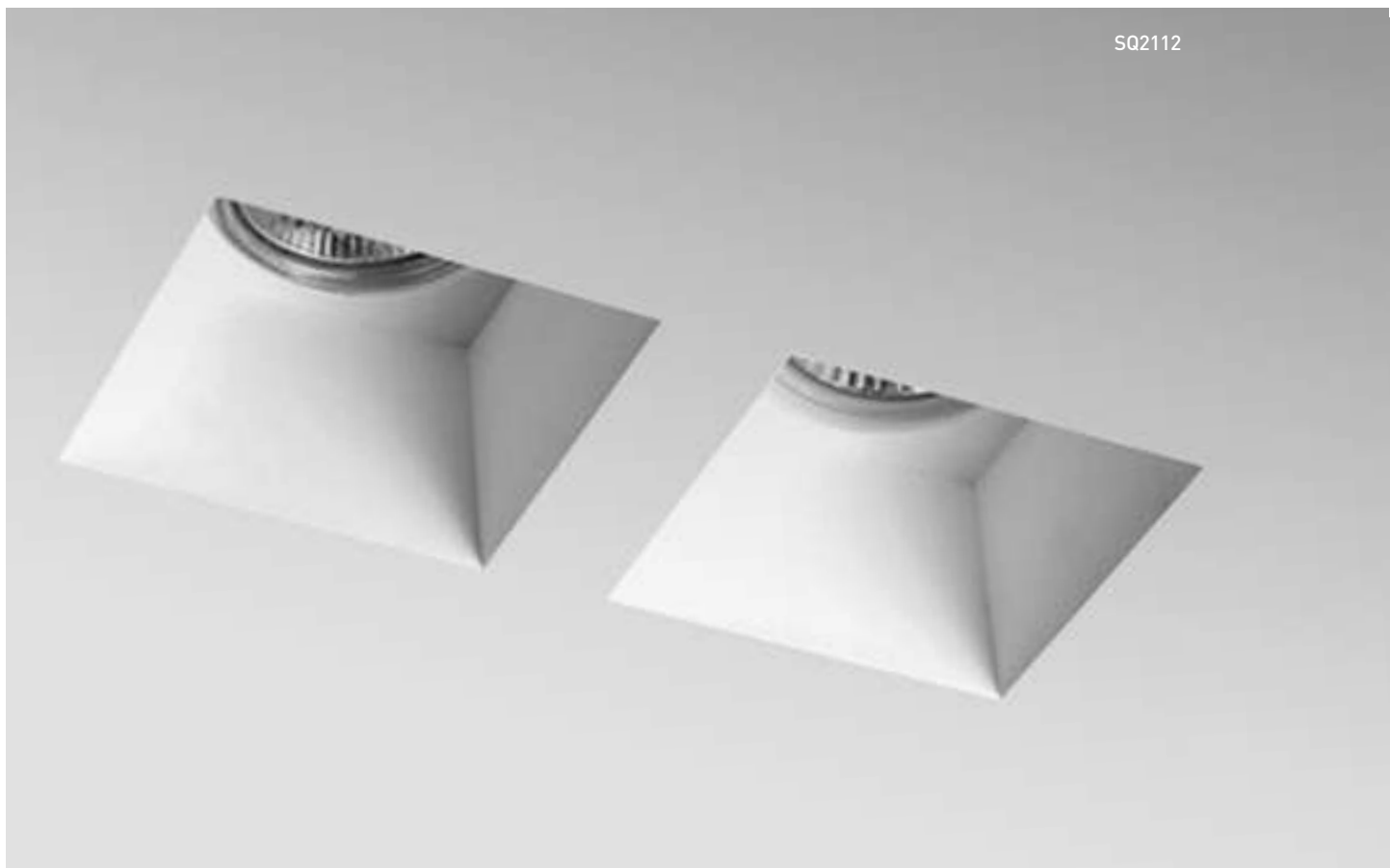

SQ2112

PORTAFARETTI - GESSO

JESSY SQUARE

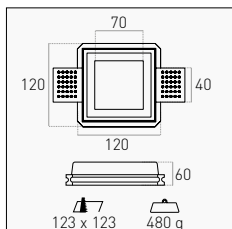

1 Slot GU10 (35W MAX) White **JESSY-SQ120GLASS** 1/24 13,50 €

220-240 V IP20 OPAL GLASS DIFFUSER PAINTABLE GESSO/PLASTER

INCLUDED

PORTALAMPADA GU10
GU10 LAMP HOLDER

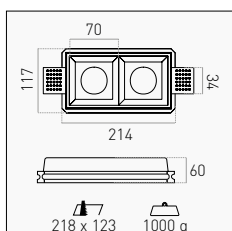

2 Slot GU10 (35W MAX) White **JESSY2-SQ2112** 1/12 24,75 €

220-240 V IP20 PAINTABLE GESSO/PLASTER

INCLUDED

PORTALAMPADA GU10
GU10 LAMP HOLDER

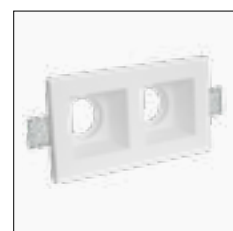

Portafaretti da incasso in gesso adatti ad essere installati in ogni controsoffitto in maniera totalmente invisibile.

Plaster recessed spotlight holder suitable to be installed in any false ceiling in a totally invisible way.

INSTALLATION



REALIZZATO IN GESSO RESINATO VERNICIABILE PER INSTALLAZIONI A SCOMPARSA
MADE OF PAINTABLE RESIN-COATED PLASTER FOR CONCEALED INSTALLATIONS

REQUIRED PAG. 36-39

LAMPADRE SPOT GU10
GU10 SPOT LAMPS

SORGENTI

GO SMART

VERSATILI

INDOOR

OUTDOOR

SOLARI

WORK

PROFESSIONAL

ESPOSITORI



PORTAFARETTI - GESSO
JESSY ROUND

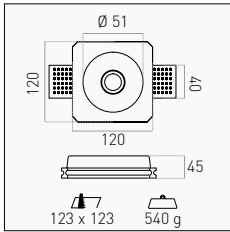

1 Slot ψ GU10 (35W MAX) White **JESSY-SR120** 1/24 12,00 €

220-240 V IP20

PAINTABLE GESSO/PLASTER

INCLUDED

PORTALAMPADA GU10
GU10 LAMP HOLDER

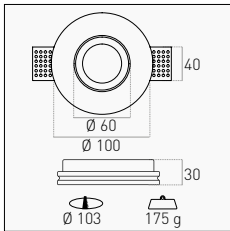
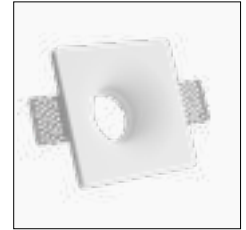

1 Slot ψ GU10 (35W MAX) White **JESSY-RD100** 1/24 9,00 €

220-240 V IP20

PAINTABLE GESSO/PLASTER

INCLUDED

PORTALAMPADA GU10
GU10 LAMP HOLDER

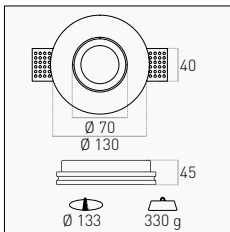

1 Slot ψ GU10 (35W MAX) White **JESSY-RD130** 1/24 13,50 €

220-240 V IP20

PAINTABLE GESSO/PLASTER

INCLUDED

PORTALAMPADA GU10
GU10 LAMP HOLDER

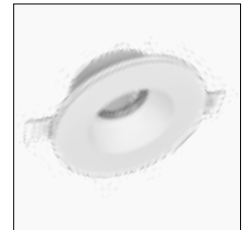

Portafaretti da incasso in gesso adatti ad essere installati in ogni controsoffitto in maniera totalmente invisibile.

Plaster recessed spotlight holder suitable to be installed in any false ceiling in a totally invisible way.

INSTALLATION



REALIZZATO IN GESSO RESINATO VERNICIABILE PER INSTALLAZIONI A SCOMPARSA
 MADE OF PAINTABLE RESIN-COATED PLASTER FOR CONCEALED INSTALLATIONS

REQUIRED PAG. 36-39



LAMPADINE SPOT GU10
GU10 SPOT LAMPS

SORGENTI

GO SMART

VERSATILI

INDOOR

OUTDOOR

SOLARI

WORK

PROFESSIONAL

ESPOSITORI



SOSPENSIONE
ENFASI STYLO

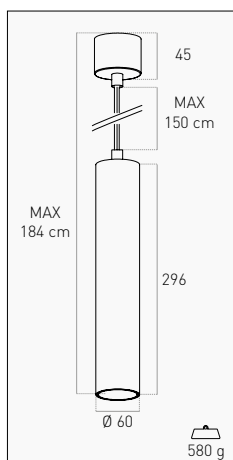

1 Slot ∇ GU10	White <input type="checkbox"/>	ENSTYB-GU10	6/24	47,50 €
	Black <input checked="" type="checkbox"/>	ENSTYN-GU10		
220-240 V IP20			ALUMINUM	5 YEARS

SORGENTI

GO SMART

VERSATILI

INDOOR

OUTDOOR

SOLARI

WORK

PROFESSIONAL

ESPOSITORI



Sospensione in alluminio per lampade spot GU10. E' possibile installare all'interno dell'apparecchio la lampada spot GU10 desiderata. Massima flessibilità ed efficacia. Lampada non inclusa.

Aluminum suspension for GU10 spot lamps. It is possible to install the desired GU10 spot lamp inside the fixture. Maximum flexibility and effectiveness. Lamp not included.

INSTALLATION



ADATTO PER ARREDARE CON STILE OGNI AMBIENTE INTERNO
SUITABLE FOR STILISH FURNITURE IN EVERY INDOOR AMBIENCE

TECHNICAL NOTES



SOSPENSIONE REGOLABILE FINO A 180 CM
ADJUSTABLE SUSPENSION UP TO 180 CM

REQUIRED PAG. 36-39



LAMPADA SPOT GU10 NON INCLUSA
GU10 SPOT LAMP NOT INCLUDED



PORTAFARETTI

ENFASI SQUARE



1 SLOT

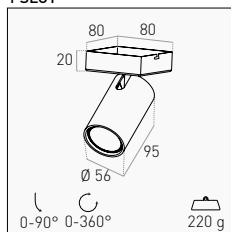

1 Slot \curvearrowright GU10	White <input type="checkbox"/>	ENSB-GU10	6/24	23,50 €
	Black <input checked="" type="checkbox"/>	ENSN-GU10		
<input type="checkbox"/> 220-240 V \sim IP20 $\not\approx$		ALUMINUM 5 YEARS		

2 SLOT

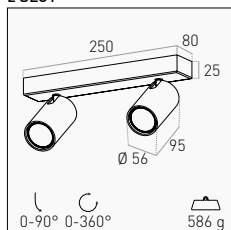

2 Slot \curvearrowright GU10	White <input type="checkbox"/>	ENSB-2GU10	1/12	39,00 €
	Black <input checked="" type="checkbox"/>	ENSN-2GU10		
<input type="checkbox"/> 220-240 V \sim IP20 $\not\approx$		ALUMINUM 5 YEARS		

3 SLOT

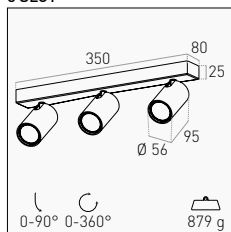

3 Slot \curvearrowright GU10	White <input type="checkbox"/>	ENSB-3GU10	1/12	57,00 €
	Black <input checked="" type="checkbox"/>	ENSN-3GU10		
<input type="checkbox"/> 220-240 V \sim IP20 $\not\approx$		ALUMINUM 5 YEARS		



Portafaretti GU10 in alluminio con base rettangolare. E' possibile installare all'interno dell'apparecchio la lampada spot GU10 desiderata. Massima flessibilità ed efficacia. Lampade non incluse.

Aluminum GU10 spotlight holder with rectangular base. It is possible to install the desired GU10 spot lamp inside the fixture. Maximum flexibility and effectiveness. Lamps not included.

TECHNICAL NOTES



RUOTABILE SU ASSE 360° - INCLINABILE 90°
ROTATABLE ON AXIS 360° - TILTABLE 90°

REQUIRED PAG. 36-39



LAMPADINE SPOT GU10 NON INCLUSE
GU10 SPOT LAMPS NOT INCLUDED

SORGENTI

GO SMART

VERSATILI

INDOOR

OUTDOOR

SOLARI

WORK

PROFESSIONAL

ESPOSITORI



PORTAFARETTI
ENFASI ROUND



PLAFONE CEILING

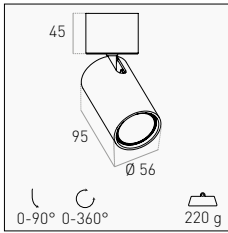

1 Slot GU10 Orientabile / Orientable	White <input type="checkbox"/>	ENRB-GU10	6/24	26,00 €
	Black <input checked="" type="checkbox"/>	ENRN-GU10		
220-240 V IP20		ALUMINUM 5 YEARS		

INCASSO RECESSED

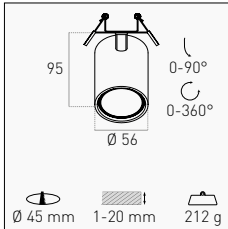

1 Slot GU10 Orientabile / Orientable	White <input type="checkbox"/>	ENIBOR-GU10	6/24	26,00 €
	Black <input checked="" type="checkbox"/>	ENINOR-GU10		
220-240 V IP20		ALUMINUM 5 YEARS		

INCASSO RECESSED

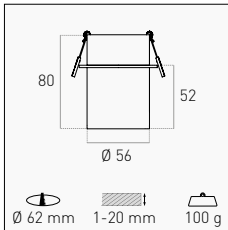

1 Slot GU10 Fisso / Fixed	White <input type="checkbox"/>	ENIB-GU10	6/24	21,25 €
	Black <input checked="" type="checkbox"/>	ENIN-GU10		
220-240 V IP20		ALUMINUM 5 YEARS		



Portafaretti GU10 in alluminio con base rotonda. E' possibile installare all'interno dell'apparecchio la lampada spot GU10 desiderata. Massima flessibilità ed efficacia. La lampada non è inclusa.

Aluminum GU10 spotlight holder with round base. It is possible to install the desired GU10 spot lamp inside the fixture. Maximum flexibility and effectiveness. The lamp is not included.

INCLUDED



ATTACCO GU10 CON BOX DI COLLEGAMENTO PROFESSIONALE
GU10 SOCKET WITH PROFESSIONAL JUNCTION BOX

TECHNICAL NOTES

MONTAGGIO RAPIDO CON CLIP
QUICK ASSEMBLY WITH CLIPS

REQUIRED PAG. 36-39



LAMPADINE SPOT GU10 NON INCLUSE
GU10 SPOT LAMPS NOT INCLUDED

ESQNG96-GU10

ESQNB160-2GU10



ESQBG160-2GU10

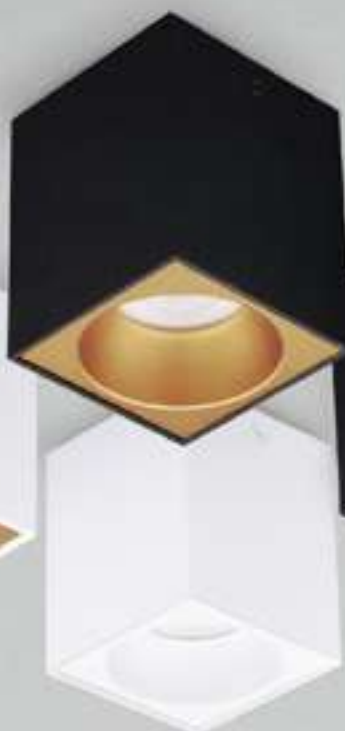

ESQBB80-GU10



APPLIQUE ESSENZA QUBE



QUBE

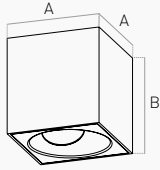

A mm	B mm	g
80	98	278
96	102	409

	A	OUT	IN			
1 Slot Ψ GU10	80 mm	White <input type="checkbox"/>	Gold <input checked="" type="checkbox"/>	ESQBG80-GU10	1/24	27,50 €
			White <input type="checkbox"/>	ESQBB80-GU10		
		Black <input checked="" type="checkbox"/>	Gold <input checked="" type="checkbox"/>	ESQNG80-GU10		
			White <input type="checkbox"/>	ESQNB80-GU10		
96 mm	White <input type="checkbox"/>	Gold <input checked="" type="checkbox"/>	ESQBG96-GU10	1/24	32,50 €	
		White <input type="checkbox"/>	ESQBB96-GU10			
	Black <input checked="" type="checkbox"/>	Gold <input checked="" type="checkbox"/>	ESQNG96-GU10			
		White <input type="checkbox"/>	ESQNB96-GU10			

220-240 V IP20
~ ⚡

ALUMINUM 5 YEARS

QUBE DOPPIO

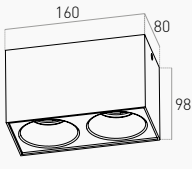

470 g

	OUT	IN			
2 Slot Ψ GU10	White <input type="checkbox"/>	Gold <input checked="" type="checkbox"/>	ESQBG160-2GU10	1/12	49,50 €
		White <input type="checkbox"/>	ESQBB160-2GU10		
	Black <input checked="" type="checkbox"/>	Gold <input checked="" type="checkbox"/>	ESQNG160-2GU10		
		White <input type="checkbox"/>	ESQNB160-2GU10		

220-240 V IP20
~ ⚡

ALUMINUM 5 YEARS

INSTALLATION

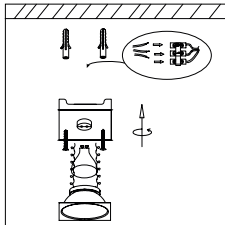

Effettuare i collegamenti elettrici, quindi montare la base a muro, quindi la lampada GU10 nell'attacco e il diffusore a molla sulla lampadina

Set up electrical connections, then mount the base on the wall, then the GU10 lamp in the socket and the spring diffuser on the bulb.

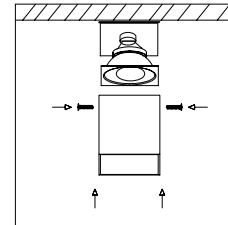

Finire il montaggio con il corpo lampada e fissarlo con le apposite viti.

Complete the installation with the lamp body and fix it with the screws.



Applique a soffitto in alluminio per lampade spot GU10. Diverse combinazioni di colore per adattarsi a tutti gli stili e tendenze.

Aluminum ceiling lamp for GU10 spot lamps. Different color combinations to suit all styles and trends.

REQUIRED PAG. 36-39



LAMPADE SPOT GU10 NON INCLUDE
GU10 SPOT LAMPS NOT INCLUDED



APPLIQUE
ESSENZA RONDÒ

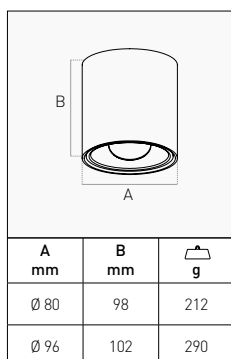

	A	OUT	IN			
1 Slot ψ GU10	Ø 80 mm	White <input type="checkbox"/>	Gold <input checked="" type="checkbox"/>	ESRBG80-GU10	1/24	27,50 €
			White <input type="checkbox"/>	ESRBB80-GU10		
		Black <input checked="" type="checkbox"/>	Gold <input checked="" type="checkbox"/>	ESRNG80-GU10		
			White <input type="checkbox"/>	ESRNB80-GU10		
Ø 96 mm	White <input type="checkbox"/>	Gold <input checked="" type="checkbox"/>	ESRBG96-GU10	1/24	32,50 €	
		White <input type="checkbox"/>	ESRBB96-GU10			
	Black <input checked="" type="checkbox"/>	Gold <input checked="" type="checkbox"/>	ESRNG96-GU10			
		White <input type="checkbox"/>	ESRNB96-GU10			

220-240 V IP20

ALUMINUM 5 YEARS

INSTALLATION

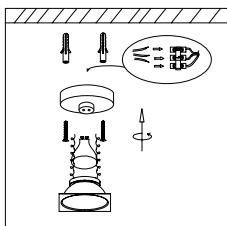

Effettuare i collegamenti elettrici, quindi montare la base a muro, quindi la lampada GU10 nell'attacco e il diffusore a molla sulla lampadina

Set up electrical connections, then mount the base on the wall, then the GU10 lamp in the socket and the spring diffuser on the bulb.

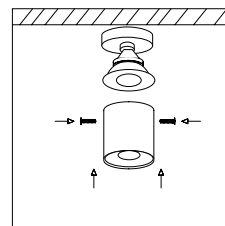

Finire il montaggio con il corpo lampada e fissarlo con le apposite viti.

Complete the installation with the lamp body and fix it with the screws.



Applique a soffitto in alluminio per lampade spot GU10. Diverse combinazioni di colore per adattarsi a tutti gli stili e tendenze.

Aluminum ceiling lamp for GU10 spot lamps. Different color combinations to suit all styles and trends.

REQUIRED PAG. 36-39



LAMPADE SPOT GU10 NON INCLUDE
GU10 SPOT LAMPS NOT INCLUDED



APPLIQUE

ESSENZA ORIENTABILE



QUBE

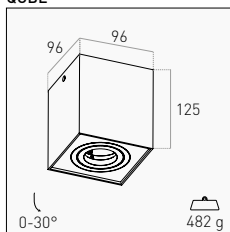

1 Slot ∇ GU10	White <input type="checkbox"/>	ESQBOR96-GU10	1/24	33,50 €
	Black <input checked="" type="checkbox"/>	ESQNOR96-GU10		
220-240 V IP20		ALUMINUM 5 YEARS		

RONDÒ

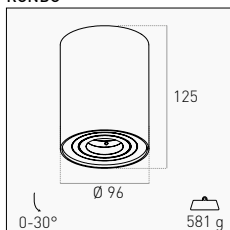

1 Slot ∇ GU10	White <input type="checkbox"/>	ESRBOR96-GU10	1/24	33,50 €
	Black <input checked="" type="checkbox"/>	ESRNOR96-GU10		
220-240 V IP20		ALUMINUM 5 YEARS		



Applique a soffitto orientabile per lampade spot GU10. Massima flessibilità ed efficacia per adattarsi a tutti gli stili e tendenze.

Adjustable ceiling wall light for GU10 spot lamps. Maximum flexibility and effectiveness to adapt to all styles and trends.

TECHNICAL NOTES



INCLINABILE SU ASSE 30°
INCLINABLE ON AXIS 30°

REQUIRED PAG. 36-39



LAMPADE SPOT GU10 NON INCLUDE
GU10 SPOT LAMPS NOT INCLUDED

SORGENTI

GO SMART

VERSATILI

INDOOR

OUTDOOR

SOLARI

WORK

PROFESSIONAL

ESPOSITORI

SOSPENSIONE
FANTASY

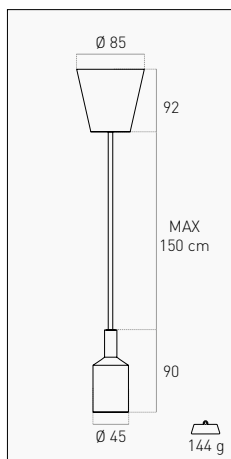

1 Slot E27	White <input type="checkbox"/>	FTBI-150	10/50	7,25 €
	Grey <input type="checkbox"/>	FTGR-150		
	Black <input type="checkbox"/>	FTNE-150		

220-240 V IP20
~ ⚡

SILICONE

Portalamпада in silicone con possibilità di svariate combinazioni di montaggio. Cavo lungo 150 cm.

Silicone lampholder with different mounting combinations. 150 cm long cable.



REQUIRED PAG. 22
LAMPADA E27 NON INCLUSA
E27 LAMP NOT INCLUDED

SOSPENSIONE
FUSION 150



SORGENTI

GO SMART

VERSATILI

INDOOR

OUTDOOR

SOLARI

WORK

PROFESSIONAL

ESPOSITORI

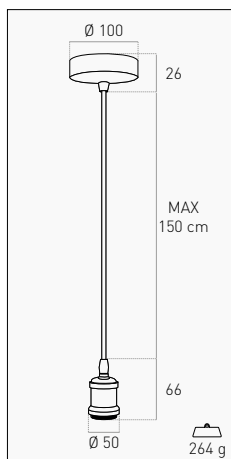

1 Slot E27	Bronze	■	FSBR-150	6/24	18,50 €
	Pearl Black	■	FSNE-150		
	Pink Gold	■	FSRG-150		
	Antique Pink Gold	■	FSRGV-150		

□ 220-240 V IP20

⊠ DIE-CAST ALUMINUM

Portalamпада in alluminio pressofuso con possibilità di svariate combinazioni di montaggio. Cavo lungo 150 cm.

Die-cast aluminum lampholder with different mounting combinations. 150 cm long cable.



REQUIRED PAG. 30

LAMPADA E27 NON INCLUSA
 E27 LAMP NOT INCLUDED



05



OUTDOOR

OUTDOOR

OUTDOOR



PROIETTORI

SIRIO SLIM
SIRIO BT
SMILE
PORTEO
RAINBOW



PLAFONIERE

OASI
PURA
NEW SIMPLY



DECORATIVO

UP&DOWN+
AXO
REVERSO
FORMA
PASEO



GARDEN

BAMBOO
FIESTA
FIESTA 230 V

SORGENTI

GO SMART

VERSATILI

INDOOR

OUTDOOR

SOLARI

WORK

PROFESSIONAL

ESPOSITORI



PROIETTORE
SIRIO SLIM

PROIETTORI
SIRIO SLIM



IP66 - ULTRA SLIM

OUTPUT

A				
B				
C				
	A	B	C	g
	mm	mm	mm	
20 W	160	147	29	480
30 W	160	147	29	480
50 W	200	178	29	760
70 W	270	230	29	1400
100 W	270	230	29	1400
150 W	366	303	34	2800
200 W	366	303	34	2800

20 W	2.100 lm	Grey ■	4000 K ■	SRS-209540	1/24	27,50 €
			6000 K ■	SRS-209560		
		White □	4000 K ■	SRSB-209540		
30 W	3.150 lm	Grey ■	4000 K ■	SRS-309540	1/24	32,50 €
			6000 K ■	SRS-309560		
		White □	4000 K ■	SRSB-309540		
50 W	5.250 lm	Grey ■	4000 K ■	SRS-509540	1/20	36,00 €
			6000 K ■	SRS-509560		
		White □	4000 K ■	SRSB-509540		
70 W	7.350 lm	Grey ■	4000 K ■	SRS-709540	1/12	65,00 €
			6000 K ■	SRS-709560		
		White □	4000 K ■	SRSB-709540		
100 W	10.500 lm	Grey ■	4000 K ■	SRS-1009540	1/12	89,00 €
			6000 K ■	SRS-1009560		
		White □	4000 K ■	SRSB-1009540		
150 W	15.750 lm	Grey ■	4000 K ■	SRS-1509540	1/6	135,00 €
			6000 K ■	SRS-1509560		
		White □	4000 K ■	SRSB-1509540		
200 W	21.000 m	Grey ■	4000 K ■	SRS-2009540	1/6	152,00 €
			6000 K ■	SRS-2009560		
		White □	4000 K ■	SRSB-2009540		

200-240 V 110°

HIGH DISSIPATION ULTRASLIM 304 STAINLESS STEEL

DIE-CAST ALUMINUM GLASS 30.000 h 35.000 h
4000 K 6000 K

TECHNICAL NOTES



VALVOLA ANTI CONDENZA IMPERMEABILE. RIMUOVE L'UMIDITÀ ED EVITA LA CONDENZA
WATERPROOF ANTI-CONDENSATION VALVE. REMOVES MOISTURE AND PREVENTS CONDENSATION



CAVO IN GOMMA H05RN-F 3 X 1.0 MM² RESISTENTE
AI RAGGI UV E ALLE BASSE TEMPERATURE. PRESSACAVO IN ACCIAIO INOX.
RUBBER CABLE H05RN-F 3X1.0 MM² RESISTANT
TO UV RAYS AND LOW TEMPERATURES. STAINLESS STEEL CABLE GLAND.

Proiettore ultraslim IP66 con un design sottile e resistente all'acqua, ideale per l'uso all'aperto. Realizzato in alluminio pressofuso e diffusore in vetro ad alta resistenza.

IP66 ultra-slim floodlight with a slim, water-resistant design, ideal for outdoor use. Made of die-cast aluminum and high resistance glass diffuser.



PROIETTORE
SIRIO BT

PROIETTORE
SIRIO BT

12-36
V/DC

IK08

IP65

SORGENTI

GO SMART

VERSATILI

INDOOR

OUTDOOR

SOLARI

WORK

PROFESSIONAL

ESPOSITORI

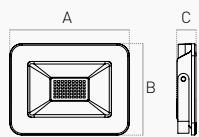

	A mm	B mm	C mm	g
20 W	120	115	24	250
30 W	155	125	24	350
50 W	200	165	33	600

OUTPUT

20 W	1.750 lm	Black ■	4000K ■	SRSBT-203640	1/20	30,00 €
30 W	2.540 lm	Black ■	4000K ■	SRSBT-303640	1/20	40,00 €
50 W	4.400 lm	Black ■	4000K ■	SRSBT-503640	1/20	72,00 €

12-36 V IP65 IK08 110° S.E.L.V. HIGH DISSIPATION ULTRASLIM DIE-CAST ALUMINUM GLASS

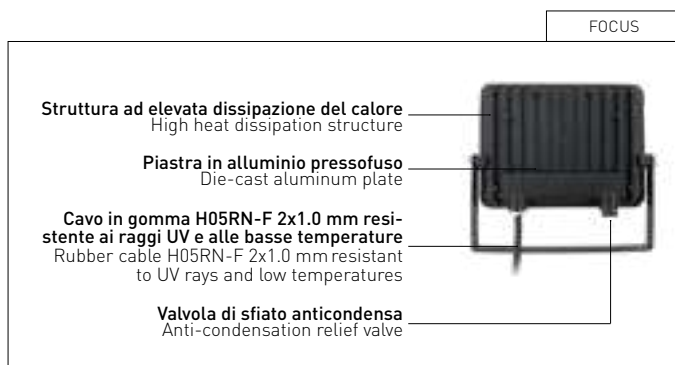

TECHNICAL NOTES

S.E.L.V. (SAFETY EXTRA LOW VOLTAGE)



NO 230 V/AC



Corpo in alluminio pressofuso, diffusore in vetro antiabbaglio, piastra in puro alluminio ad alto potere dissipante. Non adatto ad essere alimentato dalla convenzionale corrente 220-240 V/AC.

Body in die-cast aluminum, diffuser in anti-glare glass, plate in pure aluminum with high dissipating power. Not suitable to be powered by conventional 220-240 V/AC current.

IDEALE IN SISTEMI DI VIDEOSORVEGLIANZA E SICUREZZA CON PANNELLI FOTOVOLTAICI, SU IMBARCAZIONI, CAMPER, MEZZI DA CANTIERE E DI SOCCORSO.
SUITABLE FOR VIDEO SURVEILLANCE AND SECURITY SYSTEMS WITH PHOTOVOLTAIC PANELS, ON BOATS, CAMPER, CONSTRUCTION AND RESCUE VEHICLES.



PROIETTORE **SMILE**



Gamma da 10 a 200 W
Range from 10 to 200 W

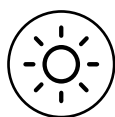

Fino a 22.500 lumen
Up to 22,500 lumens



Versione Standard o RF Sensor
Standard or RF Sensor version



Protetto contro le intemperie
Protected against the weather

Disponibile nelle versioni / Available in versions
Standard • RF and Light Sensor

PROIETTORE SMILE



SORGENTI

GO SMART

VERSATILI

INDOOR

OUTDOOR

SOLARI

WORK

PROFESSIONAL

ESPOSITORI

	A mm	B mm	C mm	g
10 W	105	70	29	150
20 W	124	95	29	220
30 W	154	125	29	340
50 W	190	145	29	500
75 W	225	180	29	745
100 W	275	220	29	1040
150 W	400	295	32	1590
200 W	400	295	32	2130

RAL 7042

OUTPUT						
10 W	1.000 lm	-	4000K	SML-109040	1/24	8,90 €
		Sensor	4000K	SMLS-109040	1/24	18,00 €
20 W	2.100 lm	-	4000K	SML-209040	1/24	13,90 €
		Sensor	4000K	SMLS-209040	1/24	21,00 €
30 W	3.350 lm	-	4000K	SML-309040	1/12	16,50 €
		Sensor	4000K	SMLS-309040	1/12	25,00 €
50 W	5.700 lm	-	4000K	SML-509040	1/6	23,00 €
		Sensor	4000K	SMLS-509040	1/6	31,00 €
75 W	8.500 lm	-	4000K	SML-759040	1/5	30,00 €
100 W	11.500 lm	-	4000K	SML-1009040	1/5	40,00 €
150 W	17.000 lm	-	4000K	SML-1509040	1/5	62,00 €
200 W	22.500 lm	-	4000K	SML-2009040	1/5	80,00 €

10-20W E E 200-240 V IP65 IK07 115°

MICROWAVE SENSOR LIGHT SENSOR HIGH DISSIPATION ULTRASLIM

STAINLESS STEEL DIE-CAST ALUMINUM PRISMATIC GLASS

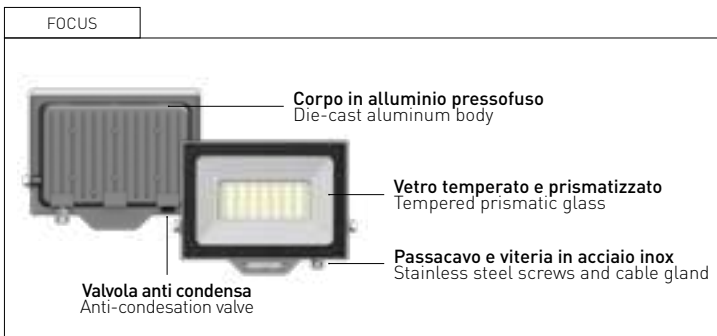

Vetro temperato con diffusore prismaticizzato, struttura in alluminio ad alta dissipazione. Versione standard o con sensore.

Tempered glass with prismatic diffuser, high dissipation aluminum structure. Standard version or with sensor.

TECHNICAL NOTES



SMLS
SENSORE CREPUSCOLARE E DI PRESENZA RF INTEGRATO
INTEGRATED RF PRESENCE AND LIGHT SENSOR

MICROWAVE SENSOR

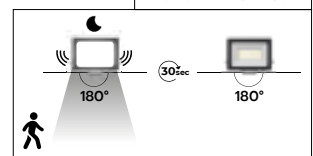

IL PROIETTORE SI ACCENDE AUTOMATICAMENTE DOPO IL TRAMONTO SE RILEVA UN MOVIMENTO NEL RAGGIO DI 6 METRI E SI SPEGNE DOPO 30 SECONDI SE NON RILEVA NESSUN MOVIMENTO. THE FLOODLIGHT TURNS ON AUTOMATICALLY AFTER SUNSET IF IT DETECTS MOVEMENT WITHIN 6 METERS AND TURNS OFF AFTER 30 SECONDS IF IT DOES NOT DETECT ANY MOVEMENT.



PROIETTORE PORTEO

TRICOLOR
3000K
4000K
6500K



SORCENTI

GO SMART

VERSATILI

INDOOR

OUTDOOR

SOLARI

WORK

PROFESSIONAL

ESPOSITORI

SOURCE OUTPUT

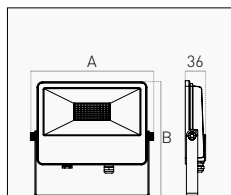

	A mm	B mm	g
20 W	162	145	510
30 W	162	145	510
40 W	227	205	900
50 W	227	205	900

RAL 9010
 RAL 8003
 RAL 9005

Power	Source	Output	Color Temp	Finish	Model	Quantity	Price	
20 W	2.710 lm	2.000 lm	3000 - 4000 - 6500 K	White	PTOBI-209500	1/24	33,50 €	
				Corten	PTOCO-209500			
				Black	PTONE-209500			
30 W	3.660 lm	3.000 lm	3000 - 4000 - 6500 K	White	PTOBI-309500	1/24	41,00 €	
				Corten	PTOCO-309500			
				Black	Sensor	PTOCOS-309500	1/24	46,00 €
					Sensor	PTONES-309500	1/24	46,00 €
40 W	5.080 lm	4.600 lm	3000 - 4000 - 6500 K	White	PTOBI-409500	1/12	53,50 €	
				Corten	PTOCO-409500			
				Black	PTONE-409500			
50 W	6.000 lm	5.000 lm	3000 - 4000 - 6500 K	Corten	PTOCOS-509500	1/12	60,00 €	
				Black	PTONES-509500			

200-240 V IP65 IK08 110° MICROWAVE SENSOR HIGH DISSIPATION ULTRASLIM DIE-CAST ALUMINUM FROSTED GLASS TRICOLOR CCT

TECHNICAL NOTES



REGOLAZIONE DEL COLORE LUCE TRAMITE SELETTORE
COLOR TEMPERATURE ADJUSTMENT THROUGH SELECTOR



Proiettore LED in alluminio pressofuso in 3 finiture e 4 potenze. Schermo in vetro smerigliato e valvola anticondensa. Resistente ad acqua e polvere. Tramite il selettore è possibile selezionare il colore luce desiderato.

Die-cast aluminum LED floodlight in 3 finishes and 4 powers. Frosted glass screen and anti-condensation valve. Resistant to water and dust. Color temperature can be selected through the switch.

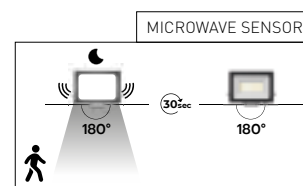
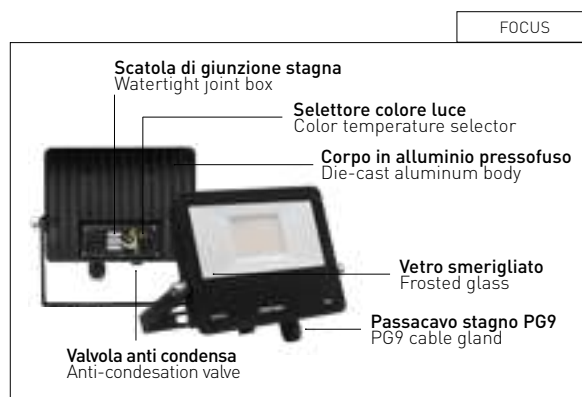

NELLA VERSIONE CON SENSORE A MICROONDE INTEGRATO, IL PROIETTORE SI ACCENDE AUTOMATICAMENTE DOPO IL TRAMONTO SE RILEVA UN MOVIMENTO NEL RAGGIO DI 6 METRI E SI SPEGNE DOPO 30 SECONDI SE NON RILEVA NESSUN MOVIMENTO.
IN MICROWAVE BUILT-IN SENSOR VERSION, THE FLOODLIGHT TURNS ON AUTOMATICALLY AFTER SUNSET IF IT DETECTS MOVEMENT WITHIN 6 METERS AND TURNS OFF AFTER 30 SECONDS IF IT DOES NOT DETECT ANY MOVEMENT.



PROIETTORE
RAINBOW

PROIETTORE
RAINBOW

IP65 - RGB



	A mm	B mm	C mm	g
10 W	104	27	125	210
50 W	200	36	237	880

10 W	RGB	RBW-109510	1/16	34,00 €
50 W	RGB	RBW-509510	1/12	67,00 €

220-240 V
 IP65
 120°
 DIMMABLE
 HIGH DISSIPATION
 ULTRASLIM
 ALUMINUM
 GLASS
 RGB



Proiettore RGB ideale per la creazione di scenari unici. Tramite il telecomando in dotazione è possibile selezionare facilmente il colore o il gioco di luce desiderato. Corpo in alluminio ad alta dissipazione.

RGB floodlight suitable for unique scenarios. Easy selection of colors or light effects by included remote control. High dissipation aluminum body.

INCLUDED



TELECOMANDO RF 2.4 GHZ
2.4 GHZ RF REMOTE CONTROL

MODE

COLORE SINGOLO SINGLE COLOR

VELOCE JUMP

DISSOLVENZA SHADE

INSTALLATION



IDEALE PER TERRAZZE, PORTICI, NEGOZI, CENTRI COMMERCIALI, GIARDINI PUBBLICI E CAPANNONI INDUSTRIALI
IDEAL FOR TERRACES, PORCHES, SHOPS, SHOPPING CENTRES, PUBLIC GARDENS AND INDUSTRIAL BUILDINGS

SORGENTI

GO SMART

VERSATILI

INDOOR

OUTDOOR

SOLARI

WORK

PROFESSIONAL

ESPOSITORI



OSOB



OSTON



OSTOBP



OSONS



OSTOBS



OSTONPS

PLAFONIERA
OASI

PLAFONIERA OASI

TRICOLOR - SENSOR - IP65



SORGENTI

GO SMART

VERSATILI

INDOOR

OUTDOOR

SOLARI

WORK

PROFESSIONAL

ESPOSITORI

OVAL

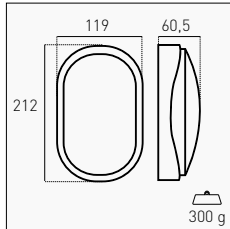

SOURCE		OUTPUT						
14 W	1.680 lm	1.400 lm	White □	-	3000 - 4000 - 6500 K	OSOB-1411900	1/12	22,50 €
				Sensor	3000 - 4000 - 6500 K	OSOBS-1411900	1/12	39,00 €
			Black ■	-	3000 - 4000 - 6500 K	OSON-1411900	1/12	22,50 €
				Sensor	3000 - 4000 - 6500 K	OSONS-1411900	1/12	39,00 €

220-240 V IP65 120° PIR SENSOR PC CCT TRICOLOR

ROUND

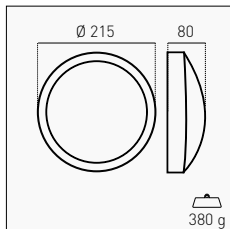

SOURCE		OUTPUT						
14 W	1.680 lm	1.400 lm	White □	-	3000 - 4000 - 6500 K	OSTOB-1421500	1/12	27,50 €
				Sensor	3000 - 4000 - 6500 K	OSTOBS-1421500	1/12	44,75 €
			Black ■	-	3000 - 4000 - 6500 K	OSTON-1421500	1/12	27,50 €
				Sensor	3000 - 4000 - 6500 K	OSTONS-1421500	1/12	44,75 €

220-240 V IP65 120° PIR SENSOR PC CCT TRICOLOR

ROUND + COVER

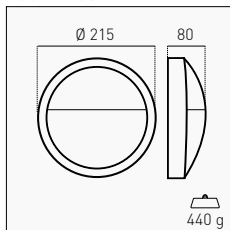

SOURCE		OUTPUT						
14 W	1.680 lm	840 lm	White □	-	3000 - 4000 - 6500 K	OSTOBP-1421500	1/12	30,00 €
				Sensor	3000 - 4000 - 6500 K	OSTOBPS-1421500	1/12	49,75 €
			Black ■	-	3000 - 4000 - 6500 K	OSTONP-1421500	1/12	30,00 €
				Sensor	3000 - 4000 - 6500 K	OSTONPS-1421500	1/12	49,75 €

220-240 V IP65 120° PIR SENSOR PC CCT TRICOLOR



Plafoniera da interno o da esterno protetto. Applicazioni soffitto-pareti con flusso luminoso uniforme.

Indoor or outdoor protected ceiling light. Ceiling-wall applications with uniform luminous flux.

FOCUS

Regolazione del sensore PIR
PIR sensor adjustment

Range: 10 sec - 5 min / 10 - 2000 lx

TECHNICAL NOTES

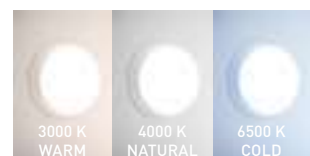

REGOLAZIONE DEL COLORE LUCE TRAMITE SELETTORE SU PIASTRA INTERNA
LIGHT COLOR ADJUSTMENT BY SELECTOR ON INTERNAL PLATE



PACBI



PACGR



PARGR



PARBI

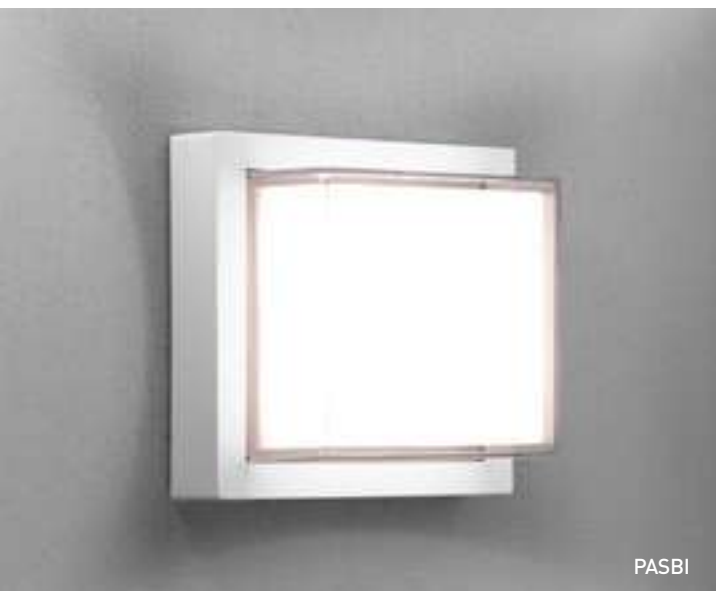

PASBI



PASGR

PLAFONIERA
PURA



IP65

CUBE

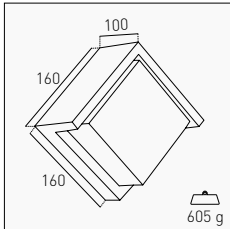

OUTPUT

10 W	920 lm	White <input type="checkbox"/>	3000 K	PACBI-101630	1/20	42,00 €
			4000 K	PACBI-101640		
		Anthracite <input type="checkbox"/>	3000 K	PACGR-101630		
			4000 K	PACGR-101640		

220-240 V IP65 120°



ROUND

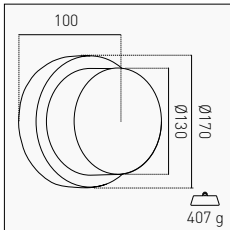

OUTPUT

10 W	920 lm	White <input type="checkbox"/>	3000 K	PARBI-101730	1/20	37,00 €
			4000 K	PARBI-101740		
		Anthracite <input type="checkbox"/>	3000 K	PARGR-101730		
			4000 K	PARGR-101740		

220-240 V IP65 120°



SQUARE

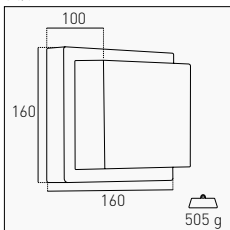

OUTPUT

10 W	920 lm	White <input type="checkbox"/>	3000 K	PASBI-101630	1/20	39,50 €
			4000 K	PASBI-101640		
		Anthracite <input type="checkbox"/>	3000 K	PASGR-101630		
			4000 K	PASGR-101640		

220-240 V IP65 120°



Plafoniera resistente agli agenti atmosferici con certificazione IP65, perfetta per illuminare gli ambienti interni ed esterni con stile. Presenta un design moderno ed è disponibile in due diverse colorazioni. Possibilità di abbinare diverse forme e finiture per la creazione di combinazioni uniche.

Weather-resistant ceiling lamp with IP65 certification, perfect for illuminating stylish indoor and outdoor environments. It features a modern design and it is available in two different colors. Possibility of mixing different shapes and finishes to create unique combinations.



INSTALLATION

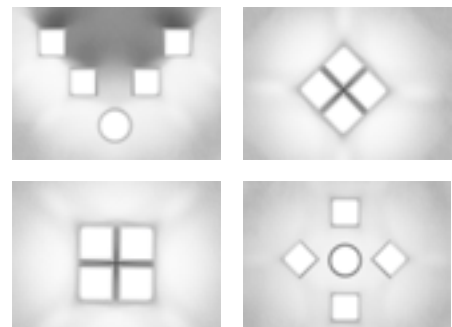

COMBINA DIFFERENTI FORME E FINITURE PER EFFETTI SCENICI UNICI
COMBINE DIFFERENT SHAPES AND FINISHES FOR UNIQUE SCENE EFFECTS

SORGENTI

GO SMART

VERSATILI

INDOOR

OUTDOOR

SOLARI

WORK

PROFESSIONAL

ESPOSITORI



SMO



SMRN



SMS



SMON



SMR



SMSN

NEW

PLAFONIERA
SIMPLY

NEW
PLAFONIERE
SIMPLY



IP65

OVAL

	A mm	B mm	C mm	g
16 W	214	115	64	250
24 W	270	146	70	407

SOURCE		OUTPUT					
16 W	1.650 lm	1.280 lm	White □	3000 K	SMO-162230 NEW	1/20	17,00 €
				4000 K	SMO-162240		
			Black ■	4000 K	SMON-162240		
24 W	2.700 lm	1.920 lm	White □	3000 K	SMO-242730 NEW	1/20	24,50 €
				4000 K	SMO-242740		
			Black ■	4000 K	SMON-242740		

220-240 V IP65 120°
 EASY TO INSTALL OPAL DIFFUSER PC

ROUND

	A mm	B mm	g
16 W	∅166	63	227
24 W	∅220	69	490

SOURCE		OUTPUT					
16 W	1.650 lm	1.280 lm	White □	4000 K	SMR-161740	1/20	17,00 €
				4000 K	SMRN-161740		
			Black ■	4000 K	SMRN-161740		
24 W	2.550 lm	1.920 lm	White □	3000 K	SMR-242230 NEW	1/20	24,50 €
				4000 K	SMR-242240		
			Black ■	4000 K	SMRN-242240		

220-240 V IP65 120°
 EASY TO INSTALL OPAL DIFFUSER PC

SQUARE

	A mm	B mm	g
16 W	150	62	247
24 W	220	73	467

SOURCE		OUTPUT					
16 W	1.800 lm	1.280 lm	White □	4000 K	SMS-161540	1/20	17,00 €
				4000 K	SMSN-161540		
			Black ■	4000 K	SMSN-161540		
24 W	2.700 lm	1.920 lm	White □	4000 K	SMS-242240	1/20	24,50 €
				4000 K	SMSN-242240		
			Black ■	4000 K	SMSN-242240		

220-240 V IP65 120°
 EASY TO INSTALL OPAL DIFFUSER PC

Plafoniera IP65 a led integrato ideale per tutti gli ambienti esterni ed interni umidi. Facile installazione. Disponibile in forme e finiture diverse per adattarsi meglio all'ambiente circostante.

IP65 integrated LED ceiling light suitable for outdoor and humid indoor ambiances. Easy installation. Available in different shapes and finishes to better adapt to the surrounding environment.



INSTALLATION



FACILE INSTALLAZIONE A PARETE O SOFFITTO CON MECCANISMO A SCATTO
EASY WALL OR CEILING INSTALLATION WITH SNAP-ON SYSTEM



APPLIQUE BIDIREZIONALE
UP&DOWN+



IP65 - TRICOLOR

SQUARE

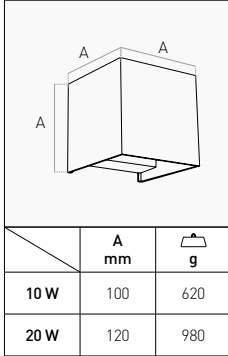

10 W	800 lm	3000 K - 4000 K - 6500 K	White <input type="checkbox"/>	UDSBI-1010	1/12	52,00 €
			Corten <input type="checkbox"/>	UDSCO-1010		
			Grey <input type="checkbox"/>	UDSGR-1010		
			Black <input type="checkbox"/>	UDSNE-1010		
20 W	1.800 lm	3000 K - 4000 K - 6500 K	White <input type="checkbox"/>	UDSBI-2012	1/12	84,00 €
			Corten <input type="checkbox"/>	UDSCO-2012		
			Grey <input type="checkbox"/>	UDSGR-2012		
			Black <input type="checkbox"/>	UDSNE-2012		



ROUND

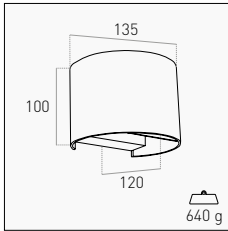

10 W	800 lm	3000 K - 4000 K - 6500 K	White <input type="checkbox"/>	UDRBI-1010	1/12	52,00 €
			Corten <input type="checkbox"/>	UDRCO-1010		
			Grey <input type="checkbox"/>	UDRGR-1010		
			Black <input type="checkbox"/>	UDRNE-1010		



INSTALLATION



TECHNICAL NOTES

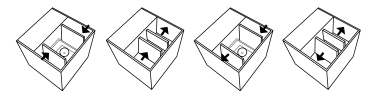

ALETTE INDIPENDENTI REGOLABILI DA 7° A 100°
INDEPENDENT FLAPS ADJUSTABLE FROM 7° TO 100°



Applique di design in alluminio con fascio luminoso bidirezionale, alette regolabili singolarmente per personalizzare ogni ambiente esterno.

Elegant aluminum wall applique with bidirectional light beam, adjustable fins to customize any outdoor ambience.

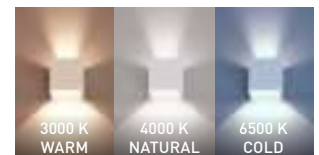

REGOLAZIONE DEL COLORE LUCE TRAMITE SELETTORE SU PIASTRA INTERNA
COLOR TEMPERATURE ADJUSTMENT THROUGH SELECTOR ON INTERNAL PLATE



APPLIQUE BIDIREZIONALE

REVERSO



IP65

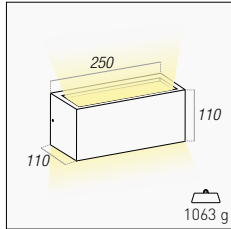

1 Slot E27	White	RVBI-E27	1/6	59,50 €
	Corten	RVCO-E27		
	Grey	RVGR-E27		
	Black	RVNE-E27		



220-240 V



IK10



DOUBLE EMISSION



OPAL PC DIFFUSER



ALUMINUM

SORGENTI

GO SMART

VERSATILI

INDOOR

OUTDOOR

SOLARI

WORK

PROFESSIONAL

ESPOSITORI



Moderna applique in alluminio a doppia emissione luminosa. Installabile in ambienti esterni. Compatibile con lampade E27.

Modern aluminum applique with double light output. Suitable for outdoor ambiances. Compatible with E27 lamps.

INSTALLATION



INSTALLABILE A PARETE PER UN EFFETTO DI LUCE BIDIREZIONALE
WALL INSTALLATION FOR A BIDIRECTIONAL LIGHT EFFECT



REQUIRED PAG. 22

LAMPADA E27 NON INCLUSA
E27 LAMP NOT INCLUDED

PER UN EFFETTO SCENICO OTTIMALE È CONSIGLIATO L'USO
DI LAMPADE INCANTO FILAMENTO COME LA ING3-082727
FOR AN OPTIMAL SCENIC EFFECT, IT IS RECOMMENDED TO USE
INCANTO FILAMENTO LAMPS LIKE ING3-082727

AXO-1GU10B

AXO-1GU10SC



AXO-2GU10G

AXO-2GU10SN



APPLIQUE AXO



IP54

ROUND - SINGLE EMISSION

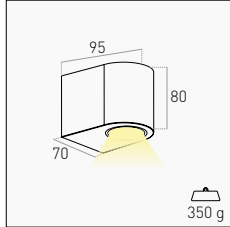

1 Slot GU10	White <input type="checkbox"/>	AXO-1GU10B	12/24	21,00 €
	Corten <input type="checkbox"/>	AXO-1GU10C		
	Grey <input type="checkbox"/>	AXO-1GU10G		
	Black <input type="checkbox"/>	AXO-1GU10N		

220-240 V IP54 IK10

GLASS DIFFUSER ALUMINUM

SQUARE - SINGLE EMISSION

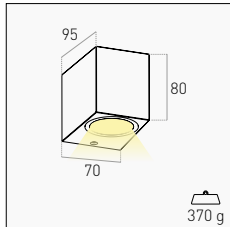

1 Slot GU10	White <input type="checkbox"/>	AXO-1GU10SB	12/24	23,50 €
	Corten <input type="checkbox"/>	AXO-1GU10SC		
	Grey <input type="checkbox"/>	AXO-1GU10SG		
	Black <input type="checkbox"/>	AXO-1GU10SN		

220-240 V IP54 IK10

GLASS DIFFUSER ALUMINUM

ROUND - DOUBLE EMISSION

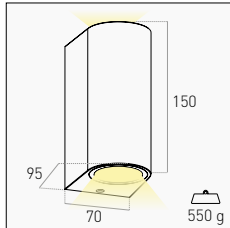

2 Slot GU10	White <input type="checkbox"/>	AXO-2GU10B	12/24	29,00 €
	Corten <input type="checkbox"/>	AXO-2GU10C		
	Grey <input type="checkbox"/>	AXO-2GU10G		
	Black <input type="checkbox"/>	AXO-2GU10N		

220-240 V IP54 IK10

DOUBLE EMISSION GLASS DIFFUSER ALUMINUM

SQUARE - DOUBLE EMISSION

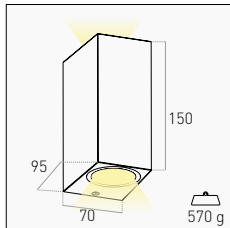

2 Slot GU10	White <input type="checkbox"/>	AXO-2GU10SB	12/24	31,00 €
	Corten <input type="checkbox"/>	AXO-2GU10SC		
	Grey <input type="checkbox"/>	AXO-2GU10SG		
	Black <input type="checkbox"/>	AXO-2GU10SN		

220-240 V IP54 IK10

DOUBLE EMISSION GLASS DIFFUSER ALUMINUM



Moderne applique in alluminio a singola o doppia emissione luminosa. Diffusore in vetro.

Modern aluminum applique with single or double light output. Glass diffuser.

REQUIRED PAG. 36-39



LAMPADE SPOT GU10 NON INCLUDE
GU10 SPOT LAMPS NOT INCLUDED

SORCENTI

GO SMART

VERSATILI

INDOOR

OUTDOOR

SOLARI

WORK

PROFESSIONAL

ESPOSITORI

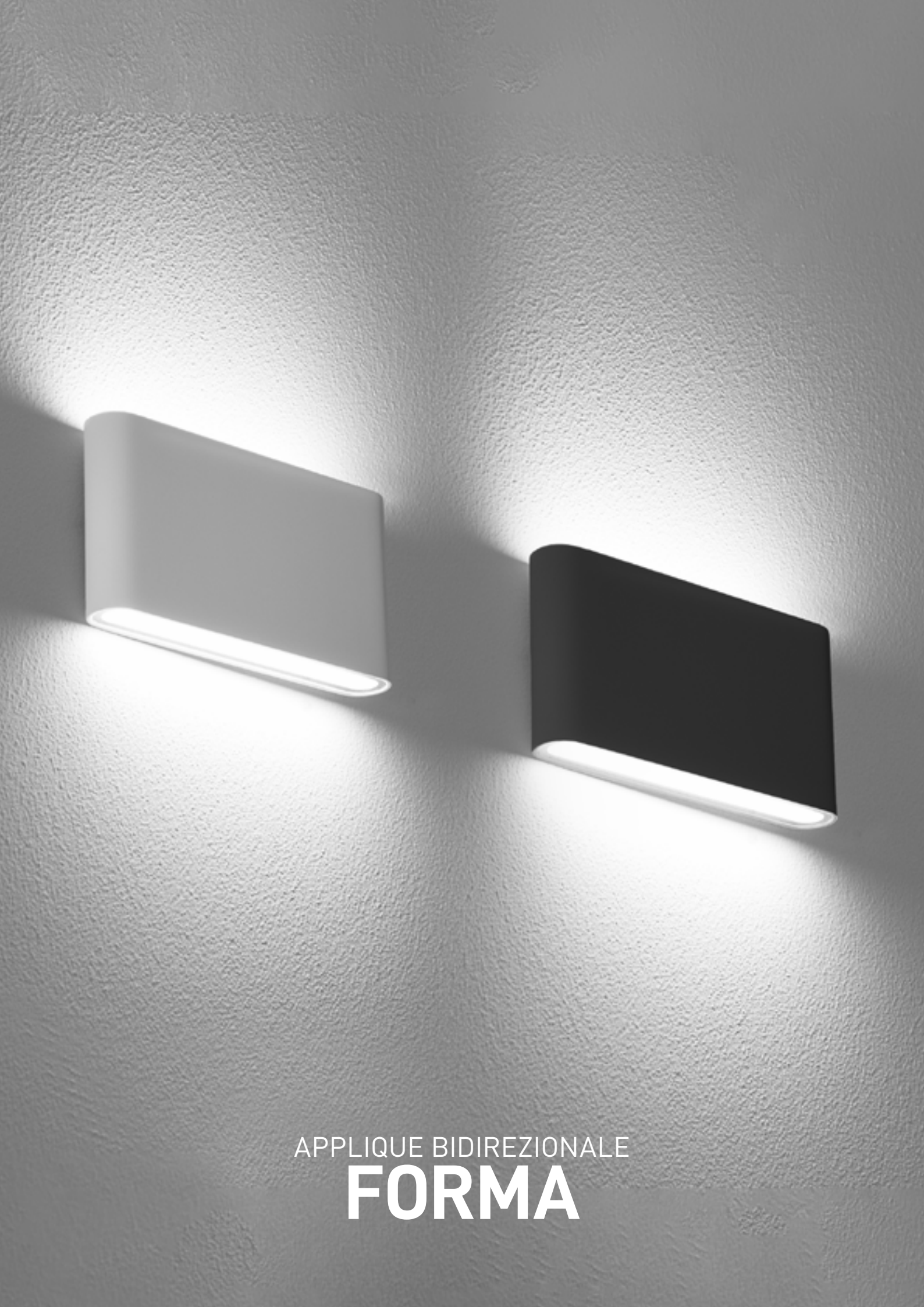

APPLIQUE BIDIREZIONALE
FORMA

APPLIQUE BIDIREZIONALE

FORMA

IP54 - TRICOLOR

TRICOLOR
3000K
4000K
6000K

IP54

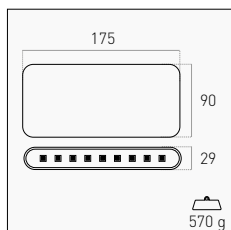

SOURCE		OUTPUT					
12 W	1.390 lm	820 lm	3000 K - 4000 K - 6000 K	White <input type="checkbox"/>	FRMB-129000	6/18	50,00 €
				Black <input checked="" type="checkbox"/>	FRMN-129000		

220-240 V IP54 120°

DOUBLE EMISSION GLASS DIFFUSER ALUMINUM CCT TRICOLOR

SORGENTI

GO SMART

VERSATILI

INDOOR

OUTDOOR

SOLARI

WORK

PROFESSIONAL

ESPOSITORI



Applique bidirezionale dal design moderno ed esclusivo. Produce un'illuminazione decorativa tramite effetto diffondente su parete.

Bidirectional wall lamp with a modern and exclusive design. Recommended for decorative lighting thanks to a diffusing effect on the wall.

INSTALLATION



INSTALLABILE A PARETE PER UN EFFETTO DI LUCE BIDIREZIONALE
WALL INSTALLATION FOR A BIDIRECTIONAL LIGHT EFFECT

TECHNICAL NOTES



REGOLAZIONE DEL COLORE LUCE TRAMITE SELETTORE SU PIASTRA INTERNA
COLOR TEMPERATURE ADJUSTMENT THROUGH SELECTOR ON INTERNAL PLATE



SEGNAPASSO
PASEO



IP54

ROUND

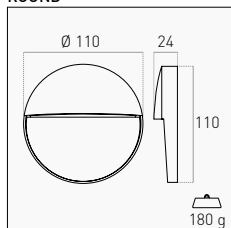

4 W	450 lm	4000 K	White <input type="checkbox"/>	PEOBIR-041140	10/50	31,00 €
			Corten <input checked="" type="checkbox"/>	PEOCOR-041140		
			Grey <input type="checkbox"/>	PEOGR-041140		
			Black <input type="checkbox"/>	PEONER-041140		

220-240 V IP54 IK06 78°

DIE-CAST ALUMINUM

SQUARE

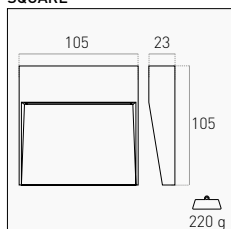

4 W	450 lm	4000 K	White <input type="checkbox"/>	PEOBIS-041040	10/50	32,50 €
			Corten <input checked="" type="checkbox"/>	PEOCOS-041040		
			Grey <input type="checkbox"/>	PEOGS-041040		
			Black <input type="checkbox"/>	PEONES-041040		

220-240 V IP54 IK06 94°

DIE-CAST ALUMINUM



Applique segnapasso dal design moderno. Corpo in alluminio pressofuso in 4 finiture.

Step light applique with a modern design. Die-cast aluminum body in 4 finishes.

INSTALLATION



FORNISCE UNA LUCE DELICATA E DIFFUSA PER ILLUMINARE PERCORSI O AREE ESTERNE
IT PROVIDES A SOFT AND DIFFUSED LIGHT TO ILLUMINATE PATHS OR OUTDOOR AREAS

SORSENTI

GO SMART

VERSATILI

INDOOR

OUTDOOR

SOLARI

WORK

PROFESSIONAL

ESPOSITORI



PALETTO DA GIARDINO
BAMBOO

PALETTO DA GIARDINO

BAMBOO



IP54

45 cm

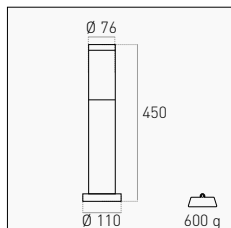

1 Slot E27	Anthracite	BMB-4527AN	1/10	34,00 €
	Corten	BMB-4527CO		

220-240 V IP54 IK06 PC DIFFUSER STAINLESS STEEL



RAL 7016 RAL 8028

80 cm

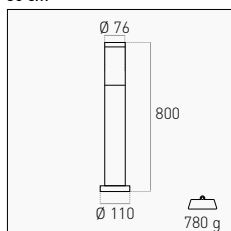

1 Slot E27	Anthracite	BMB-8027AN	1/10	42,00 €
	Corten	BMB-8027CO		

220-240 V IP54 IK06 PC DIFFUSER STAINLESS STEEL



RAL 7016 RAL 8028



Paletto da giardino dal design moderno in acciaio inossidabile e diffusore in PC. Compatibile con lampade E27 (Max 8 W), si adatta perfettamente in ogni ambiente.

Modern design garden bollard with stainless steel body and PC diffuser. Compatible with E27 lamps (Max 8 W), it suits perfectly in every outdoor space.



REQUIRED PAG. 22

LAMPADA E27 (MAX 8 W) NON INCLUSA
E27 LAMP (MAX 8 W) NOT INCLUDED

PER UN EFFETTO SCENICO OTTIMALE È CONSIGLIATO L'USO
DI LAMPADINE INCANTO FILAMENTO SATEN
FOR AN OPTIMAL SCENIC EFFECT, IT IS RECOMMENDED
TO USE SATEN INCANTO FILAMENTO LAMPS

SORGENTI

GO SMART

VERSATILI

INDOOR

OUTDOOR

SOLARI

WORK

PROFESSIONAL

ESPOSITORI

CATENA LUMINOSA

FIESTA

SPARE DRIVER
EASY

10 lampade E27 incluse
10 E27 lamp included

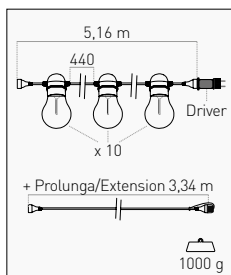

		BULB	CABLE					
6 W	500 lm	Clear	White	2200 K	FSTABCL-062722	1/5	92,00 €	
		Clear	Black	2200 K	FSTACL-062722			
	200 lm	Multicolor	Black	Multicolor	FSTACO-062722			

220-240 V E27 36 V IP44

REPLACEABLE CONNECTABLE EASY TO INSTALL

INCLUDED

10 LAMPAD E27 - ALIMENTATORE CON SPINA SCHUKO
10 E27 BULBS - DRIVER WITH SCHUKO PLUG

OPTIONAL

RICAMBIO DRIVER SPARE DRIVER

TECHNICAL NOTES

2 COLLANE LUMINOSE COLLEGABILI
2 CONNECTABLE LIGHT CHAIN

NON SUPPORTA LAMPAD E 230 V
230 V LAMPS NOT SUPPORTED

Catena luminosa di 10 lampade a filamento LED incluse alimentate a bassa tensione. Possibilità di collegare 2 catene insieme. Driver incluso con spina schuko.

String lighting with 10 LED Filament lamps included and powered by low voltage. 2 chains can be connected together. Driver included with schuko plug.

12 W **FSTADAP-12W** 1/30 18,50 €

RICAMBIO LAMPADINA E27 - 36 V/DC
E27 - 36 V/DC SPARE BULB

0,6 W	50 lm	Clear	2200 K	FSTARCL-062722	1/100	6,50 €
		Blue		FSTARBLU-062722		
	20 lm	Yellow		FSTARGI-062722		
		Magenta		FSTARMAG-062722		
		Red		FSTARRO-062722		
	Green		FSTARVE-062722			

CATENA LUMINOSA
FIESTA 230 V

STAB
EASY

SORSENTI

GO SMART

VERSATILI

INDOOR

OUTDOOR

SOLARI

WORK

PROFESSIONAL

ESPOSITORI

15 portalampe E27
 15 E27 lamp holders

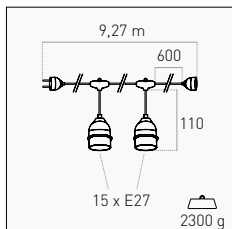

SINGLE LAMP HOLDER SYSTEM

15 Slot E27	MAX 15 W	MAX 230 W	White <input type="checkbox"/>	FSTAB-2202700	1/6	74,00 €
			Black <input checked="" type="checkbox"/>	FSTAN-2202700		

220-240 V IP44

CONNECTABLE EASY TO INSTALL

TECHNICAL NOTES

COLLEGABILE IN SERIE FINO AD UN MASSIMO DI 230 W TOTALI
 CAN BE CONNECTED IN SERIES UP TO A MAX 230 W TOTAL

INCLUDED

15 PORTALAMPADE E27 (MAX 15 W)
 15 E27 LAMP HOLDERS (MAX 15 W)

PRESA SCHUKO PER COLLEGARE IN SERIE ALTRE CATENE LUMINOSE O DISPOSITIVI ELETTRONICI
 SCHUKO SOCKET FOR CONNECT IN SERIES OTHER LIGHT CHAINS OR ELECTRONIC DEVICES



REQUIRED PAG. 22



LAMPADE E27 NON INCLUDE
 E27 LAMPS NOT INCLUDED

Catena luminosa con 15 portalampe E27, lampade non incluse. Collegabile in serie fino a 230 W totali.

String lighting with 15 E27 lamp holders, lamps not included. Connectable in series up to 230 W total.

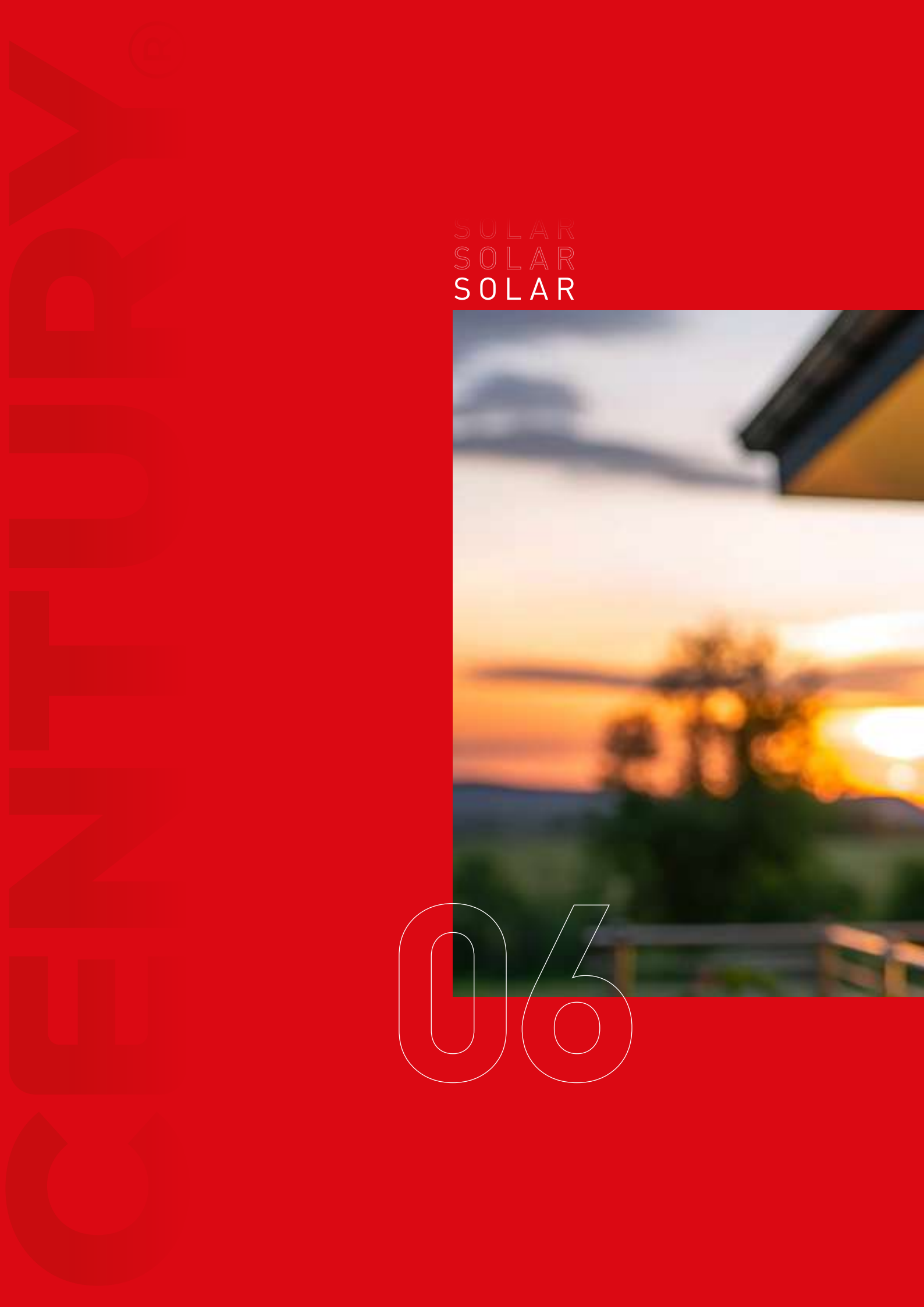

SOLAR
SOLAR
SOLAR



06



SOLARI

SOLARI

SOLARI



PROIETTORI

PROMETEO

NEW ENERGY

GIRASOLE

GENIUS

DVERSO

NEW SOLAR-B



APPLIQUE

NEW UP&DOWN SOLAR

NEW AURA

DOMINO

NEW ARCADIA MAX

ARCADIA



SEGNAPASSO

STEP SOLAR



DECORATIVO

BOLLA



PALETTO

SUNNY



LAMPIONI

SUNNY XL

LEVANTE

SORGENTI

GO SMART

VERSATILI

INDOOR

OUTDOOR

SOLARI

WORK

PROFESSIONAL

ESPOSITORI



PROIETTORE SOLARE
PROMETEO

PROIETTORE SOLARE
PROMETEO



IP65

REPLACEABLE BATTERY

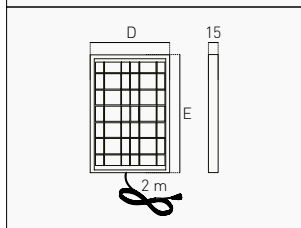
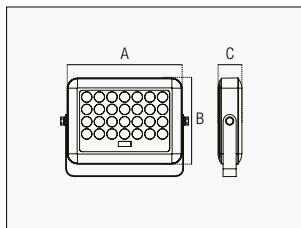

	A mm	B mm	C mm	D mm	E mm	g
5 W	180	126	35	200	210	460
10 W	243	172	39	210	340	850
20 W	243	172	39	300	390	1200
30 W	310	225	41	390	430	1680
40 W	310	225	41	390	560	1910

5 W	700 lm	LiFePO4 3,2 V 6.000 mAh	4000K	PROM-1001640	1/10	49,00 €
10 W	1.400 lm	LiFePO4 3,2 V 10.000 mAh	4000 K	PROM-2002340	1/5	71,00 €
20 W	2.700 lm	LiFePO4 3,2 V 20.000 mAh	4000 K	PROM-3002340	1/5	112,00 €
30 W	4.100 lm	LiFePO4 3,2 V 30.000 mAh	4000 K	PROM-4002940	1/5	158,00 €
40 W	4.600 lm	LiFePO4 3,2 V 40.000 mAh	4000 K	PROM-5002940	1/5	199,00 €

IP65
 IK03
 60°
 ~6-12 h WORKING TIME
 ~4-6 h RECHARGE
 LIGHT SENSOR
 MONOCRYSTALLINE
 DIMMABLE
 ABS

SORSENTI

GO SMART

VERSATILI

INDOOR

OUTDOOR

SOLARI

WORK

PROFESSIONAL

ESPOSITORI



Proiettore solare con pannello fotovoltaico monocristallino e funzione crepuscolare. Corpo in abs anti-urto. Telecomando incluso.

Solar floodlight with monocrystalline photovoltaic panel and twilight function. Shockproof abs body. Remote control included.

INCLUDED

CAVO DI COLLEGAMENTO DA 2 METRI
2 METER CONNECTION CABLE



TELECOMANDO MULTIFUNZIONE PER ACCENSIONE E SPEGNIMENTO,
REGOLAZIONE INTENSITÀ LUMINOSA E IMPOSTAZIONE TIMER
REMOTE CONTROLLER FOR SWITCHING ON/OFF,
LIGHT DIMMING AND TIMER SETTING



OPTIONAL

RICAMBIO BATTERIA REPLACEMENT BATTERY



5 W	RBPROM-100	11,00 €
10 W	RBPROM-200	18,00 €
20 W	RBPROM-300	36,00 €
30 W	RBPROM-400	52,00 €
40 W	RBPROM-500	72,00 €



NEW

PROIETTORE SOLARE

ENERGY

NEW
PROIETTORE SOLARE
ENERGY



IP65 - SENSOR

10-30 W

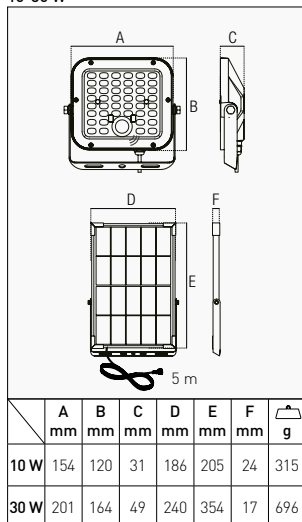

REPLACEABLE BATTERY

10 W	1.500 lm	Li-Ion 3,7 V/DC 3.600 mAh	4000 K	ERGY-1016040	1/12	69,00 €
30 W	4.800 lm	LiFePO4 6,4 V/DC 6.000 mAh	4000 K	ERGY-3016040	1/8	149,00 €

IP65
 IK07
 60° x 120°
 ~6-18 h WORKING TIME
 ~6-8 h RECHARGE
 PIR SENSOR
 LIGHT SENSOR
 MONOCRYSTALLINE
 DIMMABLE
 SMART BATTERY
 STEEL
 ABS
 PC

OPERATING MODE

MODE 1 - SENSOR MODE

Dopo il tramonto, ON al 100% al rilevamento del movimento, in modalità ridotta dopo 60 secondi.
After sunset, ON at 100% upon motion detection, in low mode after 60 seconds.

MODE 2 - ALWAYS ON

Dopo il tramonto, ON alla luminosità selezionata, dopo 3/5/8 ore o se la carica della batteria scende sotto il 30% passa alla modalità sensore.
After sunset, ON at the selected brightness, after 3/5/8 hours or if the battery charge drops below 30% it switches to sensor mode.

SMART BATTERY

Gestione intelligente della batteria in base al livello di carica, ottimizza l'efficienza energetica e le prestazioni.
Smart battery management based on charge level, optimizes energy efficiency and performance.

60 W

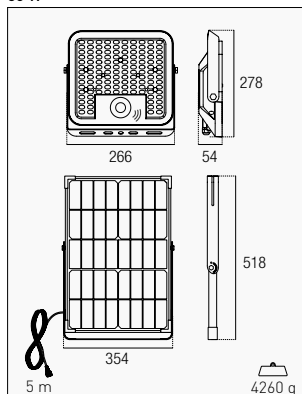

REPLACEABLE BATTERY

60 W	9.600 lm	LiFePO4 12.8 V/DC 6.000 mAh	4000 K - 6000 K	ERGY-6016000 NEW	1/4	300,00 €
------	----------	-----------------------------	-----------------	-------------------------	-----	----------

IP65
 IK07
 60° x 120°
 ~6-18 h WORKING TIME
 ~6-8 h RECHARGE
 PIR SENSOR
 LIGHT SENSOR
 GRADE-A PANEL
 CCT
 BICOLOR
 DIMMABLE
 STEEL
 ABS
 PC

OPERATING MODE

MODE 1 - ALWAYS ON

Dopo il tramonto, ON al 60% per 3 ore per poi passare alla Modalità Sensore. Regolazioni differenti tramite telecomando.
After sunset, ON at 60% for 3 hours then switch to Sensor Mode. Different settings using remote control.

MODE 2 - SENSOR MODE

Dopo il tramonto, ON al 100% al rilevamento del movimento, in modalità ridotta (5%) dopo 30 secondi.
After sunset, ON at 100% when motion is detected, in low mode (5%) after 30 seconds.

FOCUS

↑ +30% ↑
CONVERSION



IL PANNELLO SOLARE MONOCRISTALLINO GRADE-A CON VETRO LAMINATO OFFRE UNA POTENZA DI 22 W E UNA TENSIONE DI 20 V, GENERANDO IL 30% DI ENERGIA IN PIU' RISPETTO AD ALTERNATIVE DI DIMENSIONI SIMILI. IL MEGLIO NELLA SUA CATEGORIA.
THE GRADE-A MONOCRYSTALLINE SOLAR PANEL WITH LAMINATED GLASS OFFERS 22W POWER AND 20V VOLTAGE, GENERATING 30% MORE ENERGY THAN SIMILAR-SIZED ALTERNATIVES. THE BEST IN ITS CATEGORY.

INCLUDED

CAVO DI COLLEGAMENTO DA 5 METRI
5 METER CONNECTION CABLE

TELECOMANDO MULTIFUNZIONE PER ACCENSIONE, REGOLAZIONE LUMINOSITÀ E TIMER
MULTIFUNCTION REMOTE CONTROL FOR SWITCHING ON, LIGHT DIMMING AND TIMER

OPTIONAL

RICAMBIO BATTERIA REPLACEMENT BATTERY

10 W	RBERGY-10	13,00 €
30 W	RBERGY-30	25,00 €
60 W	RBERGY-60 NEW	120,00 €

Proiettore solare compatto con pannello fotovoltaico monocristallino, sensore di rilevamento del movimento e funzione crepuscolare. Corpo e scocca in plastica anti-urto.

Compact solar floodlight with monocrystalline photovoltaic panel, motion detection sensor and twilight function. Body and shockproof plastic shell.





PROIETTORE SOLARE MOTORIZZATO
GIRASOLE

PROIETTORE SOLARE MOTORIZZATO

GIRASOLE

IP65 - FOLLOW THE SUN

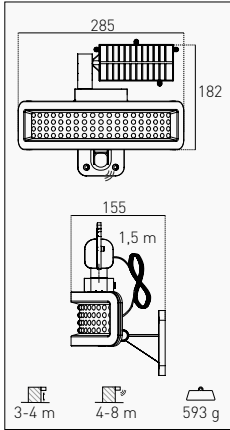

7 W	800 lm	Li-Ion 3,7 V/DC 3.600 mAh	4000 K	GRS-072840	1/12	75,00 €
-----	--------	---------------------------	--------	-------------------	------	---------

IP65
 120° WORKING TIME
 ~6 h
 ~8-12 h RECHARGE
 FOLLOW THE SUN
 SMART BATTERY
 PIR SENSOR
 LIGHT SENSOR
 SEPARABLE MONOCRYSTALLINE
 3 YEARS

OPERATING MODE

BATTERY > 30%
 Dopo il tramonto, ON automatico, 100% al passaggio, in modalità ridotta dopo 20 secondi
 Automatic ON at sunset, 100% at PIR detection, stand by mode after 20 seconds

BATTERY < 30%
 Dopo il tramonto, ON automatico, 100% al passaggio, OFF dopo 20 secondi
 Automatic ON at sunset, 100% at PIR detection, OFF after 20 seconds

SMART BATTERY

Gestione intelligente della batteria in base al livello di carica, ottimizza l'efficienza energetica e le prestazioni.
 Smart battery management based on charge level, optimizes energy efficiency and performance.

INSTALLATION



PANNELLO FOTOVOLTAICO SEPARABILE
 SEPARABLE PHOTOVOLTAIC PANEL



Dotato di un innovativo sistema di rilevamento della luce naturale, il proiettore solare è in grado di orientare automaticamente il pannello fotovoltaico per massimizzare l'irraggiamento solare. Questa innovazione ha ridotto le dimensioni del pannello fotovoltaico per un miglior impatto estetico e permette di ottenere una resa energetica significativamente maggiore, aprendo nuove prospettive per l'utilizzo dell'energia solare in modo efficiente ed economico.

Equipped with an innovative natural light detection system, the solar floodlight is able to orient the photovoltaic panel automatically to maximize solar radiation. This innovation has reduced the size of the photovoltaic panel for a better aesthetic impact and allows to obtain a significantly higher energy yield, opening up new perspectives for the efficient and economic use of solar energy.

INCLUDED

CAVO DI COLLEGAMENTO DA 1,5 METRI
 1,5 METER CONNECTION CABLE

FOCUS

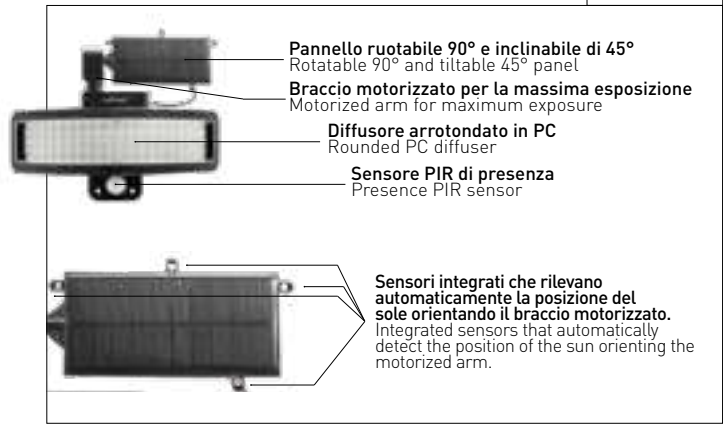

FOLLOW THE SUN



INNOVATIVO SISTEMA AUTOMATICO DI RILEVAMENTO DELLA LUCE NATURALE
 ROTAZIONE SU ASSE DI 90° - INCLINAZIONE 45°
 INNOVATIVE AUTOMATIC NATURAL LIGHT DETECTION SYSTEM
 90° ROTATION ON AXIS - 45° INCLINATION

- SORGENTI
- GO SMART
- VERSATILI
- INDOOR
- OUTDOOR
- SOLARI
- WORK
- PROFESSIONAL
- ESPOSITORI



PROIETTORE SOLARE 7-IN-1
GENIUS

PROIETTORE SOLARE 7-IN-1

GENIUS

IP65 - SENSOR



SORGENTI

GO SMART

VERSATILI

INDOOR

OUTDOOR

SOLARI

WORK

PROFESSIONAL

ESPOSITORI

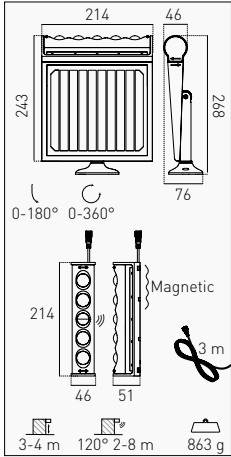

REPLACEABLE BATTERY

8 W	950 lm	Li-Ion 3,7 V/DC 4.000 mAh	4000 K	GNS-081240	1/12	74,00 €
-----	--------	---------------------------	--------	-------------------	------	---------

IP65 IK06 120° ~15 h ~6 h
WORKING TIME RECHARGE

SMART BATTERY PIR SENSOR LIGHT SENSOR
SEPARABLE MONOCRYSTALLINE MAGNETIC 7-in-1
INSTALLATION

OPERATING MODE

MODE 1 - BATTERY > 30%
Dopo il tramonto, ON automatico, 100% al passaggio, in modalità ridotta dopo 20 secondi
Automatic ON after sunset, 100% at PIR detection, low mode after 20 seconds

MODE 1 - BATTERY < 30%
Dopo il tramonto, ON automatico, 100% al passaggio, OFF dopo 20 secondi
Automatic ON after sunset, 100% at PIR detection, OFF after 20 seconds

MODE 2
ON al 100% dopo il tramonto, in modalità ridotta dopo 5 ore
ON at 100% after sunset, low mode after 5 hours

SMART BATTERY

Gestione intelligente della batteria in base al livello di carica, ottimizza l'efficienza energetica e le prestazioni.
Smart battery management based on charge level, optimizes energy efficiency and performance.

7-IN-1 INSTALLATION



A muro con pannello integrato
Integrated wall mount



A muro con pannello separato
Split wall mount



Su superficie
Standable

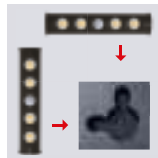

Agganciato
Hanging



Tramite magneti
With magnets

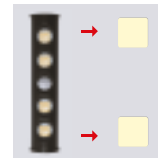

Tramite adesivi
Sticks-on



Portatile
Portable

Proiettore solare per esterno con pannello fotovoltaico monocristallino separabile fino a 3 metri che permette di illuminare anche ambienti non assolati. Ideale per illuminazione generica delle aree esterne dove non è presente la rete elettrica nelle immediate vicinanze. Installazione estremamente versatile grazie alle sue 7 modalità di utilizzo.

Outdoor solar floodlight with mono-crystalline photovoltaic panel that can be separated up to 3 meters which also allows for the illumination of non-sunny environments. Ideal for generic lighting of outdoor areas where there is no electricity grid in the immediate vicinity. Extremely versatile installation thanks to its 7 modes of use.



INCLUDED

CAVO DI COLLEGAMENTO DA 3 METRI
3 METER CONNECTION CABLE

OPTIONAL

RICAMBIO BATTERIA REPLACEMENT BATTERY

RBGNS	17,00 €
-------	---------



PROIETTORE SOLARE
DVERSO

PROIETTORE SOLARE DVERSO



IP65 - SENSOR

5 W

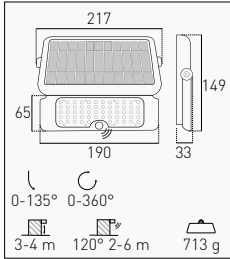

TECHNICAL NOTES



STAFFA RUOTABILE 360° - PANNELLO INCLINABILE 135°
360° ROTATABLE BRACKET - 135° ADJUSTABLE PANEL

2-IN-1 INSTALLATION

INSTALLAZIONE A PARETE O SU SUPERFICIE PIANA
WALL OR FLAT SURFACE INSTALLATION

REPLACEABLE BATTERY

5 W	500 lm	Li-Ion 3,7 V/DC 3.000 mAh	4000 K	DVS-059040	1/12	49,00 €
-----	--------	---------------------------	--------	-------------------	------	---------

IP65	IK07	90°	~12 h	~6 h	SMART BATTERY	PIR SENSOR	LIGHT SENSOR
			WORKING TIME	RECHARGE			
					MONOCRYSTALLINE	2-in-1 INSTALLATION	

OPERATING MODE

MODE 1 - CONSTANT LIGHT MODE
ON finché la capacità della batteria non si riduce a zero. Una volta ricaricato torna automaticamente alla modalità sensore.
ON until the battery capacity drops to zero. Once recharged automatically return to sensor mode.

MODE 2 - SENSOR MODE: BATTERY > 30%
Dopo il tramonto, ON al 100% al rilevamento del movimento, in modalità ridotta dopo 20 secondi.
After sunset, 100% ON on motion detection, low mode after 20 seconds.

MODE 2 - SENSOR MODE: BATTERY < 30%
Dopo il tramonto, ON al 100% al rilevamento del movimento, OFF dopo 30 secondi.
After sunset, 100% ON on motion detection, OFF after 30 seconds.

SMART BATTERY

Gestione intelligente della batteria in base al livello di carica, ottimizza l'efficienza energetica e le prestazioni.
Smart battery management based on charge level, optimizes energy efficiency and performance.

10 W

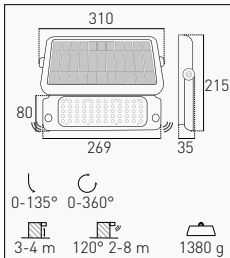

TECHNICAL NOTES



STAFFA RUOTABILE 360° - PANNELLO INCLINABILE 135°
360° ROTATABLE BRACKET - 135° ADJUSTABLE PANEL

2-IN-1 INSTALLATION



INSTALLAZIONE A MURO O A PALO TRAMITE STAFFA INCLUSA
WALL OR POLE INSTALLATION USING THE INCLUDED BRACKET

REPLACEABLE BATTERY

10 W	1.080 lm	Li-Ion 3,7 V/DC 7.200 mAh	4000 K	DVS-109040	1/12	99,00 €
------	----------	---------------------------	--------	-------------------	------	---------

IP65	IK07	90°	~20 h	~6 h	Ø 40-60 mm	SMART BATTERY	PIR SENSOR	LIGHT SENSOR
			WORKING TIME	RECHARGE	POLE CONNECTION			
						MONOCRYSTALLINE	2-in-1 INSTALLATION	3 MODES

OPERATING MODE

MODE 1 - CONSTANT LIGHT MODE
ON finché la capacità della batteria non si riduce a zero. Una volta ricaricato torna automaticamente alla modalità sensore.
ON until the battery capacity drops to zero. Once recharged automatically return to sensor mode.

MODE 2 - TWILIGHT MODE
Dopo il tramonto, ON automatico al 20% per 8 ore.
After sunset, ON automatic at 20% for 8 hours.

MODE 3 - SENSOR MODE: A
Dopo il tramonto, ON al 100% al rilevamento del movimento, in modalità ridotta dopo 20 secondi.
After sunset, 100% ON on motion detection, low mode after 20 seconds.

MODE 3 - SENSOR MODE: B
Dopo il tramonto, ON al 100% al rilevamento del movimento, OFF dopo 30 secondi.
After sunset, 100% ON on motion detection, OFF after 30 seconds.

SMART BATTERY

Gestione intelligente della batteria in base al livello di carica, ottimizza l'efficienza energetica e le prestazioni.
Smart battery management based on charge level, optimizes energy efficiency and performance.

Proiettore solare LED progettato per sfruttare al massimo l'energia del sole e generare una luce di alta qualità. Consente di annullare totalmente i costi energetici.

LED solar floodlight designed to get the maximum energy from the sun and produce high quality light. A good solution to save energy costs.



OPTIONAL

RICAMBIO BATTERIA BATTERY REPLACEMENT

5 W	RBDVS-05	11,00 €
10 W	RBDVS	27,50 €



NEW

PROIETTORE SOLARE
SOLAR-B

NEW
PROIETTORE SOLARE
SOLAR-B

IP65 - SENSOR - TRICOLOR



TRICOLOR
3000K
4000K
6500K

ACTIVATIONS REPLACEABLE BATTERY

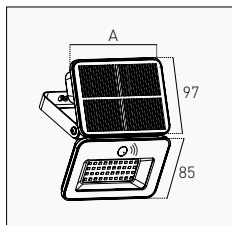

	A mm	g
8 W	143	380
12 W	194	480

8 W	800 lm	~120	Li-Ion 3.7 V/DC 2.200 mAh	3000 - 4000 - 6500 K	SLB-071400 NEW	6/12	26,50 €
12 W	1.200 lm	~180	Li-Ion 3.7 V/DC 2.600 mAh	3000 - 4000 - 6500 K	SLB-091900 NEW	6/12	35,50 €

IP65 IK04 120° ~6-8 h RECHARGE PIR SENSOR LIGHT SENSOR MONOCRYSTALLINE ABS FROSTED GLASS CCT TRICOLOR

OPERATING MODE

MODE 1 - FROM SENSOR TO LOW MODE

Dopo il tramonto, ON al 100% per 30 secondi quando il sensore rileva un movimento, poi diminuisce al 5% di luminosità.
After sunset, ON at 100% for 30 seconds when the sensor detects motion, then decreases to 5% brightness.

MODE 2 - FROM SENSOR TO OFF

Dopo il tramonto, ON al 100% per 30 secondi quando il sensore rileva un movimento, poi si spegne.
After sunset, ON at 100% for 30 seconds when the sensor detects motion, then turns off.

ACTIVATIONS



**NUMEROSE ACCENSIONI CON UNA SINGOLA CARICA!
OGNI CICLO DI RICARICA PERMETTE NUMEROSE ATTIVAZIONI DEL SENSORE,
GARANTENDO UN'ILLUMINAZIONE AFFIDABILE E DUREVOLE.**
NUMEROUS ACTIVATIONS WITH A SINGLE CHARGE!
EACH CHARGING CYCLE ALLOWS NUMEROUS IGNITIONS OF THE SENSOR,
ENSURING RELIABLE AND DURABLE LIGHTING.

FOCUS

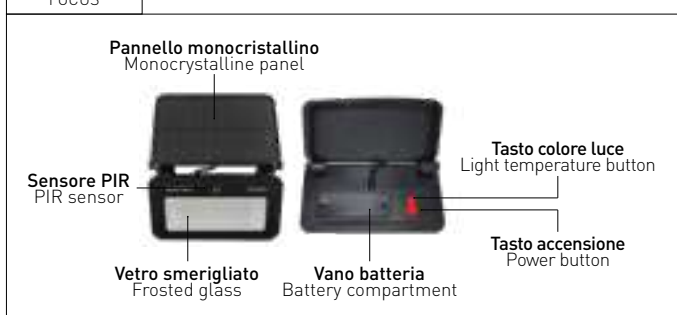

TECHNICAL NOTES

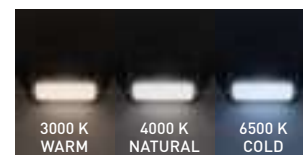

REGOLAZIONE DEL COLORE LUCE TRAMITE PULSANTE
LIGHT COLOR ADJUSTMENT BY BUTTON

OPTIONAL

RICAMBIO BATTERIA REPLACEMENT BATTERY

8 W	RBSLB-07 NEW	5,00 €
12 W	RBSLB-09 NEW	7,00 €

Proiettore solare compatto con pannello fotovoltaico. Ottima soluzione per giardini, viali, cortili; ideale per illuminazione generica delle aree esterne dove non è presente la rete elettrica nelle immediate vicinanze. Batteria sostituibile.

Compact solar floodlight with photovoltaic panel. Excellent solution for gardens, avenues, courtyards; ideal for general lighting of external areas where there is no mains power in the immediate vicinity. Replaceable battery.





NEW

APPLIQUE SOLARE

UP&DOWN SOLAR

NEW

APPLIQUE SOLARE

UP&DOWN SOLAR

IP54 - ADJUSTABLE - DOUBLE EMISSION



REPLACEABLE BATTERY

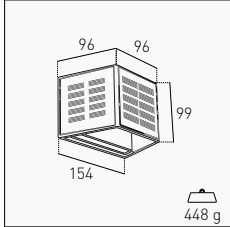

3,3 W	70 lm	Li-Ion 3,7 V/DC 1.300 mAh	3000 K	UDSOL-091530 NEW	6/24	38,00 €
			4000 K	UDSOL-091540 NEW		

IP54
 0°-120°
 ~8-10 h WORKING TIME
 ~5-6 h RECHARGE

DOUBLE EMISSION
 ADJUSTABLE
 LIGHT SENSOR
 MONOCRYSTALLINE X3
 ABS
 GLASS

TECHNICAL NOTES

ALETTE INDIPENDENTI REGOLABILI DA 0° A 120°
 INDEPENDENT FLAPS ADJUSTABLE FROM 0° TO 120°

INSTALLATION



INSTALLAZIONE A PARETE PER UN EFFETTO DI LUCE BIDIREZIONALE
 WALL INSTALLATION FOR A BIDIRECTIONAL LIGHT EFFECT



ADJUSTABLE



Applique solare di design con triplo pannello fotovoltaico ad alta conversione, fascio luminoso bidirezionale, alette regolabili singolarmente per personalizzare ogni ambiente esterno.

Solar wall light with triple high conversion photovoltaic panel, bi-directional light beam, individually adjustable flaps to personalize any outdoor environment.



OPTIONAL

RICAMBIO BATTERIA REPLACEMENT BATTERY



RBUDSOL NEW 6,00 €



NEW

APPLIQUE SOLARE

AURA

NEW

APPLIQUE SOLARE

AURA

IP54 - SENSOR



SORGENTI

GO SMART

VERSATILI

INDOOR

OUTDOOR

SOLARI

WORK

PROFESSIONAL

ESPOSITORI

OVAL

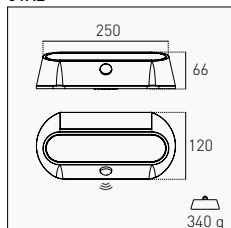

ROUND

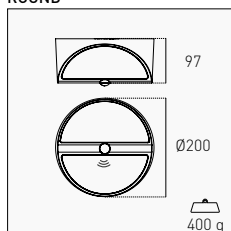

ACTIVATIONS REPLACEABLE BATTERY

5 W 500 lm ~120 Li-Ion 3,7 V/DC 2.000 mAh	White <input type="checkbox"/> 4000 K	AUOBI-052540 NEW	4/16	34,00 €
	Black <input checked="" type="checkbox"/> 4000 K	AUONE-052540 NEW		

IP54 120° ~8-10 h RECHARGE SMART BATTERY PIR SENSOR LIGHT SENSOR MONOCRYSTALLINE ABS PC 3 MODES

ACTIVATIONS REPLACEABLE BATTERY

5 W 500 lm ~120 Li-Ion 3,7 V/DC 2.000 mAh	White <input type="checkbox"/> 4000 K	AURBI-052040 NEW	4/16	39,00 €
	Black <input checked="" type="checkbox"/> 4000 K	AURNE-052040 NEW		

IP54 120° ~8-10 h RECHARGE SMART BATTERY PIR SENSOR LIGHT SENSOR MONOCRYSTALLINE ABS PC 3 MODES

OPERATING MODE

MODE 1 - LOW MODE
Dopo il tramonto, ON al 10%, passa al 100% per 30 secondi quando il sensore rileva un movimento, poi torna al 10%.
After sunset, ON at 10%, switches to 100% for 30 seconds when the sensor detects motion, then returns to 10%.

MODE 2 - ONLY SENSOR
Dopo il tramonto, la luce resta spenta, si attiva per 30 secondi quando il sensore rileva un movimento, poi si spegne.
After sunset, the light remains off, activates for 30 seconds when the sensor detects motion, then turns off.

MODE 3 - ALWAYS ON
Dopo il tramonto, ON in modalità ridotta al 10% per una durata di circa 8-10 ore, il sensore è disattivato.
After sunset, ON in 10% low mode for about 8-10 hours, the sensor is deactivated.

SMART BATTERY

Gestione intelligente della batteria in base al livello di carica, ottimizza l'efficienza energetica e le prestazioni.
Smart battery management based on charge level, optimizes energy efficiency and performance.

FOCUS

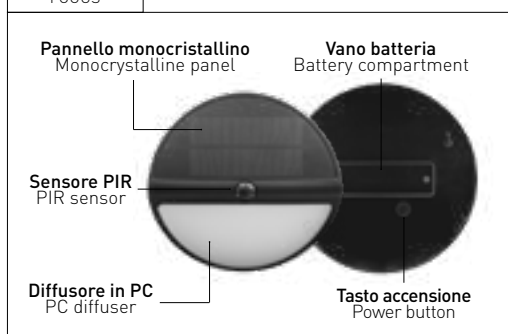

ACTIVATIONS

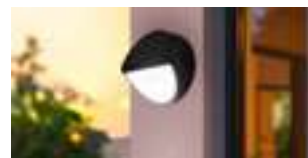

Applique solare dal design elegante. Ottima soluzione per illuminare giardini, viali e cortili in modo sostenibile, a costo zero; ideale per zone non coperte da rete elettrica. Rapida installazione. Batteria sostituibile.

Solar wall light with an elegant design. Excellent solution for lighting gardens, avenues and courtyards in a sustainable way, at zero cost; ideal for areas not covered by mains power. Quick installation. Replaceable battery.



NUMEROSE ACCENSIONI CON UNA SINGOLA CARICA! OGNI CICLO DI RICARICA PERMETTE NUMEROSE ATTIVAZIONI DEL SENSORE, GARANTENDO UN'ILLUMINAZIONE AFFIDABILE E DUREVOLE.
NUMEROUS ACTIVATIONS WITH A SINGLE CHARGE! EACH CHARGING CYCLE ALLOWS NUMEROUS IGNITIONS OF THE SENSOR, ENSURING RELIABLE AND DURABLE LIGHTING.

OPTIONAL

RICAMBIO BATTERIA REPLACEMENT BATTERY

RBAURA NEW	4,00 €
-------------------	--------



APPLIQUE SOLARE
DOMINO

APPLIQUE SOLARE DOMINO



IP65 - SENSOR

DOMINO

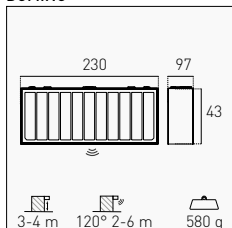

FOCUS



SMART BATTERY

Gestione intelligente della batteria in base al livello di carica.
Smart battery management based on charge level.

REPLACEABLE BATTERY

6 W 800 lm Li-Ion 3,7 V 4.000 mAh	White <input type="checkbox"/>	3000 K	DOMBI-061230	1/12	50,00 €
		4000 K	DOMBI-061240		
	Black <input checked="" type="checkbox"/>	3000 K	DOMNE-061230		
		4000 K	DOMNE-061240		

IP65 IK07 70° x 140° ~15 h WORKING TIME ~5-6 h RECHARGE SMART BATTERY PIR SENSOR LIGHT SENSOR MONOCRYSTALLINE ABS PC

OPERATING MODE

MODE 1 - SENSOR MODE: BATTERY > 30%
Al tramonto, ON al 10%, 100% al rilevamento del movimento, in modalità ridotta al 10% dopo 20 secondi.
At sunset, ON at 10%, 100% at motion detection, in low mode at 10% after 20 seconds.

MODE 1 - SENSOR MODE: BATTERY < 30%
Al tramonto, ON al 10%, 100% al rilevamento del movimento, OFF dopo 20 secondi.
At sunset, ON at 10%, 100% at motion detection, OFF after 20 seconds.

MODE 2 - ALWAYS ON
Al tramonto, ON al 50%, dopo 5 ore o se la carica della batteria scende sotto il 30% passa alla modalità sensore.
At sunset, ON at 50%, after 5 hours or if the battery charge drops below 30% it switches to sensor mode.

DOMINO MINI

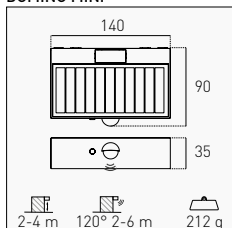

INSTALLATION



INSTALLAZIONE A PARETE PER UN EFFETTO DI LUCE BIDIREZIONALE
WALL INSTALLATION FOR A BIDIRECTIONAL LIGHT EFFECT

Applique solare con pannello fotovoltaico integrato, sensore crepuscolare e sensore PIR di movimento. Design moderno e lineare che garantisce un'illuminazione versatile. Doppia emissione luminosa per il modello 3 W, singola emissione per il 6 W.

Solar wall light with integrated photovoltaic panel, twilight sensor and PIR motion sensor. Modern and linear design that guarantees versatile lighting. Double light emission for the 3 W model, single emission for the 6 W.



REPLACEABLE BATTERY

3 W 350 lm Li-Ion 3,7 V 1.200 mAh	White <input type="checkbox"/>	3000 K	DOMBI-031230	6/24	29,00 €
		4000 K	DOMBI-031240		
	Black <input checked="" type="checkbox"/>	3000 K	DOMNE-031230		
		4000 K	DOMNE-031240		

IP65 IK07 70° + 120° ~12-16 h WORKING TIME ~4-6 h RECHARGE DOUBLE EMISSION PIR SENSOR LIGHT SENSOR MONOCRYSTALLINE ABS PC

OPERATING MODE

SENSOR MODE: A
Dopo il tramonto, ON automatico al 100% al rilevamento del movimento, in modalità ridotta dopo 10 secondi in biemissione.
After sunset, ON automatic 100% upon detection of movement, in low mode after 10 seconds in biemission.

SENSOR MODE: B
Dopo il tramonto, ON automatico al 100% al rilevamento del movimento, in modalità ridotta dopo 10 secondi in emissione superiore.
After sunset, ON automatic 100% on motion detection, in low mode after 10 seconds in upper emission.

FOCUS

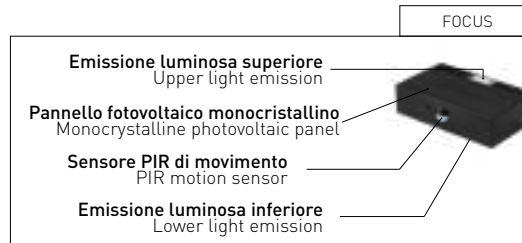

OPTIONAL

RICAMBIO BATTERIA REPLACEMENT BATTERY

6 W	RBDOM	8,75 €
3 W	RBDOM-03 NEW	5,00 €

SORSENTI

GO SMART

VERSATILI

INDOOR

OUTDOOR

SOLARI

WORK

PROFESSIONAL

ESPOSITORI



NEW

APPLIQUE SOLAIRE

ARCADIA MAX

NEW

APPLIQUE SOLARE

ARCADIA MAX

IP65 - SENSOR



SORSENTI

GO SMART

VERSATILI

INDOOR

OUTDOOR

SOLARI

WORK

PROFESSIONAL

ESPOSITORI

3 W

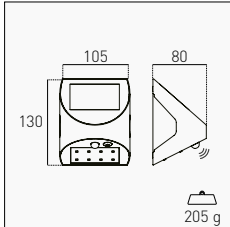

ACTIVATIONS

BATTERY

3 W 300 lm ~120 Li-Ion 3,7 V/DC 1.200 mAh	White <input type="checkbox"/> 4000 K	ACMBI-031040 NEW	1/12	17,00 €
	Black <input checked="" type="checkbox"/> 4000 K	ACMNE-031040 NEW		

IP65 IK05 120° ~12-15 h RECHARGE

DOUBLE EMISSION PIR SENSOR LIGHT SENSOR

MONOCRYSTALLINE ABS PC

OPERATING MODE

MODE 1 - DOUBLE LIGHT

Dopo il tramonto, la luce posteriore si attiva per tutta la notte e quella anteriore si accende per 30 secondi quando il sensore rileva un movimento.
After sunset, the rear light turns on all night and the front light turns on for 30 seconds when the sensor detects motion.

MODE 2 - FRONT LIGHT

Dopo il tramonto, la luce posteriore resta spenta e quella anteriore si attiva per 30 secondi quando il sensore rileva un movimento.
After sunset, the rear light stays off and the front light turns on for 30 seconds when the sensor detects motion.

6 W

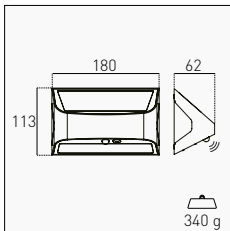

ACTIVATIONS

BATTERY

6 W 600 lm ~120 Li-Ion 3,7 V/DC 2.400 mAh	White <input type="checkbox"/> 4000 K	ACMBI-061840 NEW	1/12	26,50 €
	Black <input checked="" type="checkbox"/> 4000 K	ACMNE-061840 NEW		

IP65 IK05 120° ~12-15 h RECHARGE

DOUBLE EMISSION PIR SENSOR LIGHT SENSOR

MONOCRYSTALLINE ABS PC

OPERATING MODE

MODE 1 - DOUBLE LIGHT

Dopo il tramonto, la luce posteriore si attiva per tutta la notte e quella anteriore si accende per 30 secondi quando il sensore rileva un movimento.
After sunset, the rear light turns on all night and the front light turns on for 30 seconds when the sensor detects motion.

MODE 2 - FRONT LIGHT

Dopo il tramonto, la luce posteriore resta spenta e quella anteriore si attiva per 30 secondi quando il sensore rileva un movimento.
After sunset, the rear light stays off and the front light turns on for 30 seconds when the sensor detects motion.

ACTIVATIONS



**NUMEROSE ACCENSIONI CON UNA SINGOLA CARICA!
OGNI CICLO DI RICARICA PERMETTE NUMEROSE ATTIVAZIONI DEL SENSORE,
GARANTENDO UN'ILLUMINAZIONE AFFIDABILE E DUREVOLE.
NUMEROUS ACTIVATIONS WITH A SINGLE CHARGE!
EACH CHARGING CYCLE ALLOWS NUMEROUS IGNITIONS OF THE SENSOR,
ENSURING RELIABLE AND DURABLE LIGHTING.**

INSTALLATION

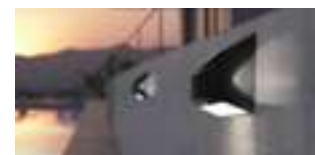

**INSTALLAZIONE A PARETE PER UN EFFETTO DI LUCE BIDIREZIONALE
WALL INSTALLATION FOR A BIDIRECTIONAL LIGHT EFFECT**

Applique solare a doppia emissione luminosa con pannello fotovoltaico integrato. Ottima soluzione per illuminare giardini, viali e cortili in modo sostenibile, a costo zero; ideale per zone non coperte da rete elettrica. Rapida installazione.

Solar wall light with double light emission with integrated photovoltaic panel. Excellent solution for lighting gardens, avenues and courtyards in a sustainable way, at zero cost; ideal for areas not covered by the mains power. Quick installation.

APPLIQUE SOLARE
ARCADIA

IP65



8 W

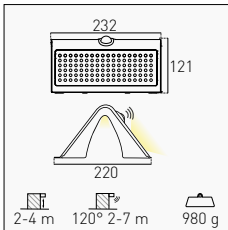

REPLACEABLE BATTERIES

8 W	850 lm	2 x Li-Ion 3,7 V 2.000 mAh	4000 K	ACSB-681240	1/12	86,50 €
-----	--------	----------------------------	--------	--------------------	------	---------



IP65



IK07



120°



~12-16 h



~4-6 h



SMART BATTERY



DOUBLE EMISSION



PIR SENSOR



LIGHT SENSOR



MONOCRYSTALLINE



PBT



PC

OPERATING MODE

MODE 1 - SENSOR MODE: BATTERY > 30%

Dopo il tramonto, ON al 10%, 100% al rilevamento del movimento, in modalità stand by al 10% dopo 20 secondi in biemissione.
After sunset, ON at 10%, 100% upon motion detection, in stand-by mode at 10% after 20 seconds in double emission.

MODE 1 - SENSOR MODE: BATTERY < 30%

Dopo il tramonto, ON al 10%, 100% al rilevamento del movimento, in modalità stand by al 10% dopo 20 secondi in emissione posteriore.
After sunset, ON at 10%, 100% at motion detection, in stand by mode at 10% after 20 seconds in back emission.

MODE 2 - ALWAYS ON

Dopo il tramonto, ON al 50%, dopo 5 ore o se la carica della batteria scende sotto il 30% passa alla modalità sensore.
After sunset, ON at 50%, after 5 hours or if the battery charge drops below 30% it switches to sensor mode.



SMART BATTERY

Applique solare a doppia emissione luminosa con pannello fotovoltaico integrato. Ottima soluzione per illuminare giardini, viali e cortili in modo sostenibile, a costo zero; ideale per zone non coperte da rete elettrica. Rapida installazione.

Solar wall light with double light emission with integrated photovoltaic panel. Excellent solution for lighting gardens, avenues and courtyards in a sustainable way, at zero cost; ideal for areas not covered by the mains power. Quick installation.

Gestione intelligente della batteria in base al livello di carica, ottimizza l'efficienza energetica e le prestazioni.
Smart battery management based on charge level, optimizes energy efficiency and performance.

OPTIONAL

RICAMBIO BATTERIE REPLACEMENT BATTERIES



8 W	RBACS-3268	7,50 €
-----	-------------------	--------

SEGNAPASSO CALPESTABILE-CARRABILE SOLARE

STEP SOLAR

IP67



SORGENTI

GO SMART

VERSATILI

INDOOR

OUTDOOR

SOLARI

WORK

PROFESSIONAL

ESPOSITORI

REPLACEABLE BATTERY

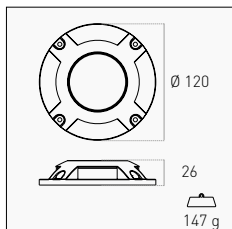

0,04 W	5 lm	Ni-MH 1,2 V/DC 600 mAh (AAA)	3000 K	STEPS-041230	6/48	19,00 €			
			4000 K	STEPS-041240					
		~18-24 h	~6-8 h						
IP67	IK07	WORKING TIME	RECHARGE	DRIVEWAY	WALKABLE	LIGHT SENSOR	MONOCRYSTALLINE	ALUMINUM	PC

Solida struttura in alluminio pressofuso che garantisce robustezza e resistenza nel tempo. Il diffusore opale in policarbonato offre una diffusione uniforme della luce, creando un'illuminazione omogenea e piacevole.

Solid die-cast aluminum structure that guarantees sturdiness and resistance over time. The opal polycarbonate diffuser offers a uniform diffusion of light, creating a homogeneous and pleasant lighting.

INSTALLATION



PERFETTO PER CENTRI STORICI, VIALI, GIARDINI E PARCHI, CON UN'INSTALLAZIONE RAPIDA. PERFECT FOR HISTORIC CENTRES, AVENUES, GARDENS AND PARKS, WITH QUICK INSTALLATION.



LAMPADA SOLARE
BOLLA

LAMPADA SOLARE
BOLLA



RGB+W

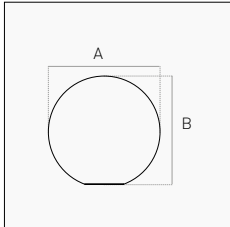

	A mm	B mm	g
0,4 W	Ø 250	230	490
0,7 W	Ø 300	290	680
0,9 W	Ø 400	390	1370

0,4 W	3 lm	Li-Ion 3,7 V/DC 1.200 mAh	RGB + 3000K	BLL-042500	1/4	67,00 €
0,7 W	4 lm	Li-Ion 3,7 V/DC 1.200 mAh	RGB + 3000K	BLL-043000	1/2	80,00 €
0,9 W	7 lm	Li-Ion 3,7 V/DC 1.200 mAh	RGB + 3000K	BLL-044000	1/1	112,00 €

IP44
 360°
 ~48 h WORKING TIME
 ~6-8 h RECHARGE
 DIMMABLE
 LIGHT SENSOR
 MONOCRYSTALLINE
 PE
 RGB+W

TECHNICAL NOTES

NON È NECESSARIO SCAVARE TRACCE, PASSARE CAVI O REALIZZARE IMPIANTI ELETTRICI
IT IS NOT NECESSARY TO DIG TRACKS, RUN CABLES OR MAKE ELECTRICAL SYSTEMS



RICARICABILE TRAMITE PANNELLO FOTOVOLTAICO INTERNO O CON CAVO USB-C INCLUSO
RECHARGEABLE WITH INTERNAL PHOTOVOLTAIC PANEL OR WITH INCLUDED USB-C CABLE

INSTALLATION



ADATTA A OGNI AMBIENTE PER CREARE UN'ATMOSFERA ACCOGLIENTE E RILASSANTE.
SUITABLE FOR ANY AMBIENCE TO CREATE A WELCOMING AND RELAXING ATMOSPHERE.



SCEGLI TRA LA LUCE BIANCA CALDA E LE TONALITÀ DI COLORE PREFERITE.
CHOOSE BETWEEN WARM WHITE LIGHT AND YOUR FAVORITE COLOR TONES.

Si ricarica autonomamente grazie al pannello fotovoltaico interno oppure utilizzando il cavo USB-C incluso. Il picchetto ed il telecomando inclusi ne facilitano l'installazione nel terreno e la selezione del colore luce tra calda o multicolore.



It recharges on its own thanks to the built-in photovoltaic panel or by using the included USB-C cable. The spike and remote control included allow an easy installation in the ground and select light temperature between warm or multicolor.

INCLUDED

CAVO DI RICARICA USB-C
USB-C CHARGING CABLE

TELECOMANDO MULTIFUNZIONE
MULTIFUNCTION REMOTE CONTROL

PICCHETTO PER TERRENO
STAKE FOR GROUND INSTALLATION

SORSENTI
GO SMART
VERSATILI
INDOOR
OUTDOOR
SOLARI
WORK
PROFESSIONAL
ESPOSITORI



SISTEMA MODULARE SOLARE
SUNNY

IP65 - TRICOLOR

KIT PALETTA

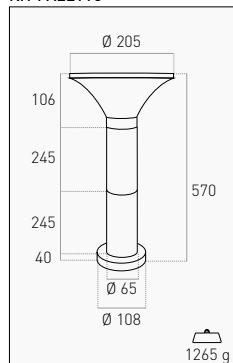

BATTERY

2 W	160 lm	Li-Ion 4,2 V/DC 4.400 mAh	3000 K - 4000 K - 6000 K	SUN-056000	1/4	99,00 €
-----	--------	---------------------------	--------------------------	-------------------	-----	---------

IP65	IK08	360°	~10 h WORKING TIME	-5-8 h RECHARGE	3-in-1 INSTALLATION	LIGHT SENSOR	MONOCRYSTALLINE
					ALUMINUM	PC DIFFUSER	TRICOLOR

INCLUDED

SORGENTE LUMINOSA + 2 MODULI PALO + ANELLO FILETTATO DI FISSAGGIO
LIGHT SOURCE + 2 POLE MODULES + THREADED FIXING RING

TECHNICAL NOTES

NON È NECESSARIO SCAVARE TRACCE, PASSARE CAVI O REALIZZARE IMPIANTI ELETTRICI
IT IS NOT NECESSARY TO DIG TRACKS, RUN CABLES OR MAKE ELECTRICAL SYSTEMS

SORGENTE LUMINOSA
LIGHT SOURCE

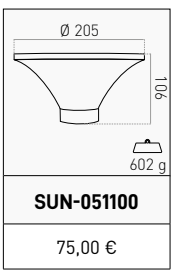

PICCHETTO PER TERRENO
GROUND SPIKE

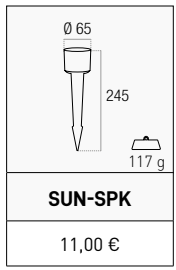

BASE PER SUPERFICIE
SURFACE BASE

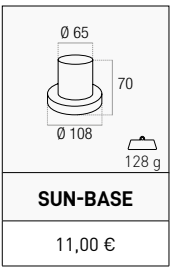

STAFFA DA PARETE
WALL BRACKET

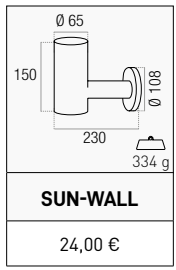

MODULO PALO
POLE MODULE

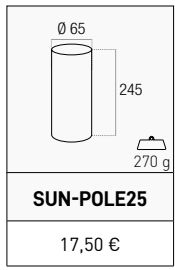

3-IN-1 INSTALLATION

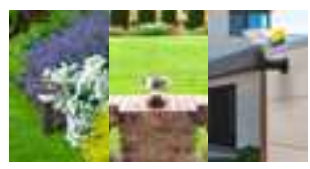

PALETTA, SEGNAPASSO O APPLIQUE
GARDEN BOLLARD, STEP MARKER OR APPLIQUE

Sistema modulare solare costruito interamente in alluminio e con diffusore in PC. Accensione automatica al tramonto. Diverse modalità di installazione grazie agli accessori in alluminio opzionali.

Solar modular system built entirely in aluminum and with PC diffuser. Automatic switch-on at sunset. Different ways of installation thanks to the aluminum optional accessories.



INSTALLATION

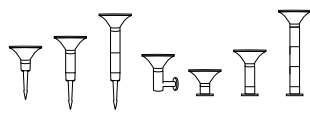

POSSIBILI COMBINAZIONI
POSSIBLE COMBINATIONS

TECHNICAL NOTES



REGOLAZIONE DEL COLORE LUCE TRAMITE PULSANTE
LIGHT COLOR ADJUSTMENT BY BUTTON

SORGENTI

GO SMART

VERSATILI

INDOOR

OUTDOOR

SOLARI

WORK

PROFESSIONAL

ESPOSITORI

LAMPIONE SOLARE ROTOSIMMETRICO

SUNNY XL



LAMPIONE SOLARE ROTOSIMMETRICO

SUNNY XL



IP65

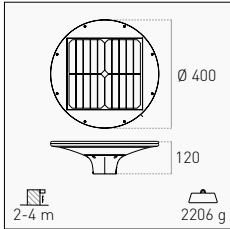

REPLACEABLE BATTERY

15 W	2.000 lm	LiFePO4 6,4 V/DC 6.000 mAh	3000 K	SUNXL-204030	1/1	179,00 €
			4000 K	SUNXL-204040		

IP65 IK07 360° ~15 h WORKING TIME ~4-6 h RECHARGE Ø 50-60 mm POLE CONNECTION SMART BATTERY LIGHT SENSOR
 MONOCRYSTALLINE ALUMINUM PC DIFFUSER

OPERATING MODE

Al tramonto, ON al 100% per le prime 3 ore, al 70% per le successive 2 ore, infine al 50% fino ad esaurimento.
 At sunset, ON at 100% for the first 3 hours, at 70% for the next 2 hours, then at 50% until battery runs out.

Con il sistema di gestione intelligente, SUNNY XL regolerà la luminosità in base alla capacità dinamica della batteria.
 Thanks to an intelligent management system, SUNNY XL dynamically adjusts the brightness according to the battery capacity.

SMART BATTERY

Gestione intelligente della batteria in base al livello di carica, ottimizza l'efficienza energetica e le prestazioni.
 Smart battery management based on charge level, optimizes energy efficiency and performance.

TECHNICAL NOTES

NON È NECESSARIO SCAVARE TRACCE, PASSARE CAVI O REALIZZARE IMPIANTI ELETTRICI
 IT IS NOT NECESSARY TO DIG TRACKS, RUN CABLES OR MAKE ELECTRICAL SYSTEMS



Lampione solare rotosimmetrico ideale per l'illuminazione esterna. Dotato di sensore crepuscolare, gestione intelligente della batteria e diffusore in policarbonato, assicura un'illuminazione ottimale, efficiente ed ecologica.

Rotosymmetrical solar street light ideal for outdoor lighting. Equipped with a twilight sensor, intelligent battery management and polycarbonate diffuser, it ensures optimal, efficient and ecological lighting.

INSTALLATION

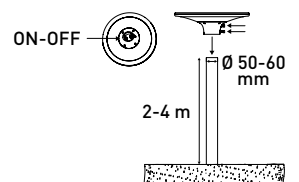

N.B. PALO NON INCLUSO
 POLE NOT INCLUDED



INSTALLABILE SU PALI DA Ø 50-60 MM PER UN'ILLUMINAZIONE EFFICIENTE ED ECOLOGICA
 CAN BE INSTALLED ON Ø 50-60 MM POST FOR EFFICIENT AND ECOLOGICAL LIGHTING

OPTIONAL

RICAMBIO BATTERIA BATTERY REPLACEMENT

RBSUNXL-20	45,00 €
-------------------	---------

SORGENTI

GO SMART

VERSATILI

INDOOR

OUTDOOR

SOLARI

WORK

PROFESSIONAL

ESPOSITORI

LAMPIONE SOLARE
LEVANTE



40 W



15 W

LAMPIONE SOLARE LEVANTE

IP65 - SENSOR



REPLACEABLE BATTERY

WORKING TIME

15 W	1.600 lm	LiFePO4 7,4 V 5.400 mAh	~8 h	4000 K	LVT-159540	1/10	120,00 €
40 W	4.800 lm	LiFePO4 9,6 V 12.000 mAh	~12-16 h	4000 K	LVT-409540	1/8	360,00 €



Ø 40-60 mm
POLE CONNECTION



SMART BATTERY



LIGHT SENSOR



MONOCRYSTALLINE



PIR SENSOR



DIMMABLE (40 W)



3-in-1
INSTALLATION

3
YEARS (40 W)

OPERATING MODE

MODE 1

ON automatico al tramonto in modalità ridotta di intensità, OFF all'alba
Automatic ON at sunset in low intensity mode, OFF at sunrise

MODE 2 - BATTERY > 30%

ON automatico al tramonto, 100% al passaggio, in modalità ridotta dopo 20 secondi
Automatic ON at sunset, 100% at PIR detection, to low intensity mode after 20 seconds

MODE 2 - BATTERY < 30%

ON automatico al tramonto, 100% al passaggio, in modalità ridotta dopo 20 secondi, OFF dopo 5 minuti
Automatic ON at sunset, 100% at PIR detection, in low intensity after 20 seconds, OFF after 5 minutes



SMART BATTERY

Gestione intelligente della batteria in base al livello di carica, ottimizza l'efficienza energetica e le prestazioni.
Smart battery management based on charge level, optimizes energy efficiency and performance.

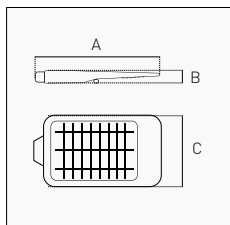

	A mm	B mm	C mm
15 W	413	58	232
40 W	710	74	287
	m	120°-m	g
15 W	3-5	5-8	1660
40 W	3-7	8-12	5130

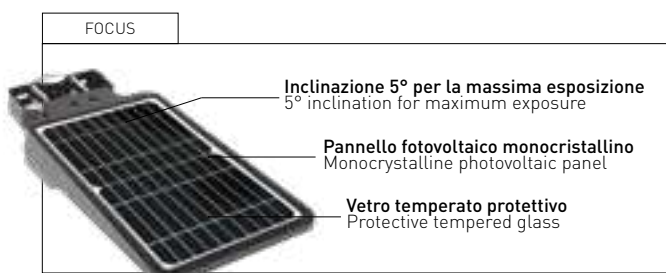

Lampione solare progettato per sfruttare al massimo l'energia del sole e generare una luce di alta qualità. Palo non incluso. Batteria sostituibile, accensione switch power.

Solar street lamp designed to make the most of the sun's energy and generate high quality light. Pole not included. Replaceable battery, switch power ignition.

3-IN-1 INSTALLATION

INCLUDED

STAFFA A U PER PALI DRITTI DA Ø40-60 MM
U-BRACKET FOR Ø40-60 MM STRAIGHT POLES

STAFFA CURVA PER PALI DA Ø40-50 MM
CURVED BRACKET FOR Ø40-50 MM POLES

STAFFA PER FISSAGGIO A MURO
WALL FIXING BRACKET

TELECOMANDO RF MULTIFUNZIONE (40 W)
MULTIFUNCTION RF REMOTE CONTROL (40 W)

OPTIONAL

RICAMBIO ATTACCO PALO SPARE POLE MOUNT

Ø 40-60 mm	ATPLVT	19,00 €
------------	---------------	---------

RICAMBIO BATTERIA BATTERY REPLACEMENT

15 W	RBLVT	45,00 €
40 W	RBLVT40 NEW	165,00 €

SORSENTI

GO SMART

VERSATILI

INDOOR

OUTDOOR

SOLARI

WORK

PROFESSIONAL

ESPOSITORI

NEW
E
C



07



WORK
WORK
WORK

SORGENTI

GO SMART

VERSATILI

INDOOR

OUTDOOR

SOLARI

WORK

PROFESSIONAL

ESPOSITORI



IBRIDO

NEW REWORK HYBRID



CAVO

REWORK

REWORK TREPPEDI



BATTERIA

JOLLY



SUPPORTI

STAND

TRIPOD



NEW

PROIETTORE PORTATILE AD ALIMENTAZIONE IBRIDA

REWORK HYBRID

NEW

PROIETTORE PORTATILE AD ALIMENTAZIONE IBRIDA

REWORK HYBRID

IP65 - DUAL POWER HYBRID

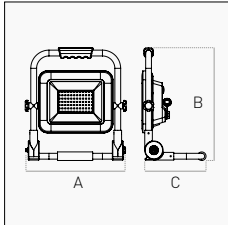

	A mm	B mm	C mm	g
70 W	335	375	200	2169
100 W	395	430	260	3184

BATTERY SLOT	SOURCE	OUTPUT					
1	70 W	9.100 lm	7.000 lm	4000 K	RWH-7010040 NEW	1/4	145,00 €
2	100 W	13.000 lm	10.000 lm	4000 K	RWH-10010040 NEW	1/4	199,00 €

220-240 V IP65 IK07 120°

 HYBRID DIMMABLE 1,5 m - H07RN-F FROSTED GLASS DIE-CAST ALUMINUM 3 YEARS

FOCUS



OPERATING MODE

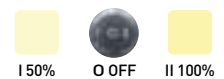

LUCE DIMMERABILE TRAMITE INTERRUTTORE A BILANCIERE
DIMMABLE LIGHT WITH POWER ROCKER SWITCH

INCLUDED



ADATTATORI PER BATTERIE DA 18 V DELLE MIGLIORI MARCHE DI
ELETTROUTENSILI, 1 PER TIPO PER IL 70 W E 2 PER IL 100 W
ADAPTERS FOR 18 V BATTERIES OF THE BEST BRANDS OF
POWER TOOLS, 1 OF TYPE FOR 70 W AND 2 FOR 100 W

CAVO H07RN-F DA 1,5 M, PRESA IP65, SPINA
SCHUKO PER L'ALIMENTAZIONE A 230 V
1.5M H07RN-F CABLE, IP65 SOCKET,
SCHUKO PLUG FOR 230V POWER SUPPLY



REQUIRED

BATTERIE E CARICATORI NON INCLUSI,
IL PROIETTORE NON RICARICA LE BATTERIE.
BATTERIES AND CHARGERS NOT INCLUDED,
THE FLOODLIGHT DOES NOT CHARGE THE BATTERIES.

WORKING TIME

	70 W		100 W*	
	50%	100%	50%	100%
2 A	60 min	30 min	40 min	20 min
4 A	120 min	60 min	80 min	40 min
6 A	180 min	90 min	120 min	60 min
8 A	240 min	120 min	160 min	80 min



Proiettore innovativo che trasforma il modo di lavorare grazie alla sua versatilità e potenza. Funziona sia con alimentazione a 230 V che con batterie ricaricabili da 18 V. Rework Hybrid garantisce illuminazione costante e affidabile ovunque serva.

Innovative and versatile work light that transforms the way you work thanks to its versatility and power. It works with both 230 V power and 18 V rechargeable batteries. Rework Hybrid guarantees constant and reliable lighting wherever it is needed.

*Il modello da 100 W è dotato di 2 slot per batterie. I tempi indicati si riferiscono all'uso di una singola batteria.
The 100 W model features 2 battery slots. The indicated times refer to the use of a single battery.
I marchi Bosch®, Milwaukee®, Makita® e DeWalt® non sono di proprietà di Century Italia S.R.L. e il prodotto non è né fabbricato, né sponsorizzato, né approvato dai suddetti marchi, che sono di proprietà esclusiva delle rispettive aziende.
The Bosch®, Milwaukee®, Makita® and DeWalt® trademarks are not the property of Century Italia S.R.L. and the product is neither manufactured nor sponsored nor endorsed by these trademarks, which are the exclusive property of their respective companies.

SORGENTI
GO SMART
VERSATILI
INDOOR
OUTDOOR
SOLARI
WORK
PROFESSIONAL
ESPOSITORI

PROIETTORE DA LAVORO
REWORK



PROIETTORE CON MANICO FLOODLIGHT WITH HANDLE

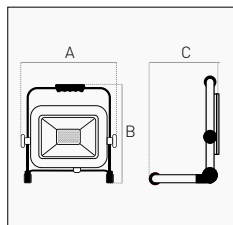

	A mm	B mm	C mm	g
30 W	250	250	180	1300
50 W	292	280	180	1556
70 W	340	370	190	2108
100 W	400	430	250	2960
150 W	400	430	250	3080
200 W	445	475	250	4168

30 W	2.530 lm	4000 K		RW-308540	1/4	47,50 €
50 W	4.425 lm	4000 K		RW-508540	1/4	57,50 €
70 W	5.990 lm	4000 K		RW-708540	1/4	72,50 €
100 W	8.350 lm	4000 K		RW-1008540	1/4	92,50 €
150 W	12.800 lm	4000 K		RW-1508540	1/4	112,00 €
200 W	17.000 lm	4000 K		RW-2008540	1/4	151,00 €

220-240 V IP65 IK05 115°

1,5 m - H07RN-F DIE-CAST ALUMINUM

Proiettore portatile alimentato da rete elettrica. Base in metallo e corpo in alluminio pressofuso con vernice epossidica.

Mains powered portable floodlight. Metal base and die-cast aluminum body with epoxy paint.

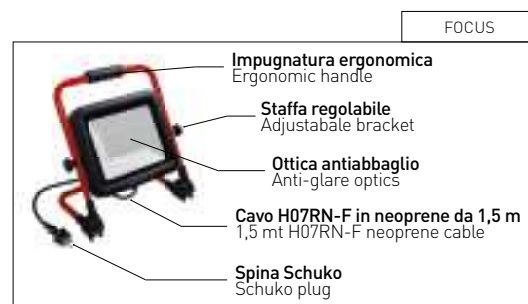

PROIETTORI CON TREPPIEDI
REWORK



SORGENTI

GO SMART

VERSATILI

INDOOR

OUTDOOR

SOLARI

WORK

PROFESSIONAL

ESPOSITORI

2 PROIETTORI CON TREPPIEDI
2 FLOODLIGHTS WITH TRIPOD

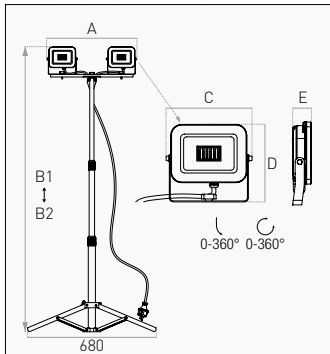

	A mm	B1-B2 mm	C g	D mm	E mm	g
2x30W	527	770-1600	3560	176	159	33
2x50W	568	810-1640	4240	218	203	35

	SOURCE		OUTPUT					
	2 x 30 W	2 x 3.050 lm	2 x 2.530 lm	4000 K		RWT2-608540	1/2	92,00 €
	2 x 50 W	2 x 5.200 lm	2 x 4.425 lm	4000 K		RWT2-1008540	1/2	117,00 €

220-240 V IP65 IK05 115°
 ADJUSTABLE 2,5 m - H07RN-F DIE-CAST ALUMINUM

Treppiedi in metallo con 2 proiettori in alluminio. Altezza regolabile. Proiettori ruotabili 360°.

Metal tripod with 2 aluminum floodlights. Adjustable height. 360° rotatable floodlights.

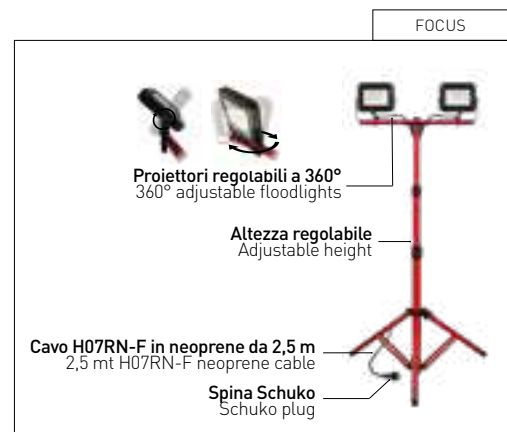

PROIETTORE RICARICABILE

JOLLY



RECHARGEABLE BATTERY

30 W	2.550 lm	Li-Ion 3,7 V/DC 8.800 mAh	4000 K	JL-308540	1/8	93,00 €
50 W	4.250 lm	Li-Ion 11,1 V/DC 4.400 mAh	4000 K	JL-508540	1/8	149,00 €

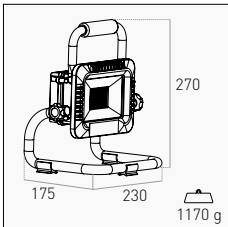

IP54 IK05 120° ~12 h WORKING TIME ~6 h RECHARGE

POWERBANK RECHARGEABLE 4 MODES

OPERATING MODE

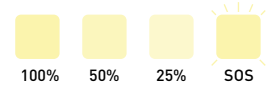

INCLUDED

30 W
ADATTATORE DA PARETE E CAVO MICRO USB
WALL ADAPTER AND MICRO USB CABLE

50 W
ALIMENTATORE DOMESTICO 230 V/AC
230 V / AC DOMESTIC POWER SUPPLY

Faro LED ricaricabile ad alta potenza. 4 modalità di funzionamento. Autonomia fino a 12h. Controllo livello batteria tramite LED sul retro.

High power rechargeable LED floodlight. 4 operating modes. Working time up to 12h. LED battery level control on the back.

FOCUS

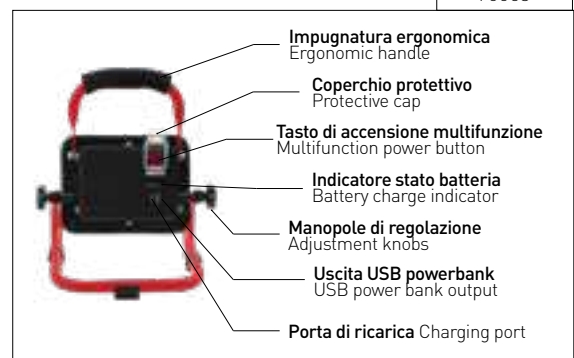

FLOODLIGHT SUPPORTS

SUPPORTI PER PROIETTORI



STAND

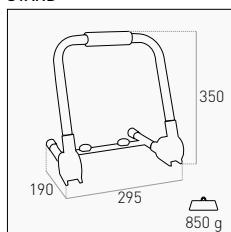

STAND50	1/5	27,50 €
----------------	-----	---------



METAL

TREPPIEDI TRIPOD

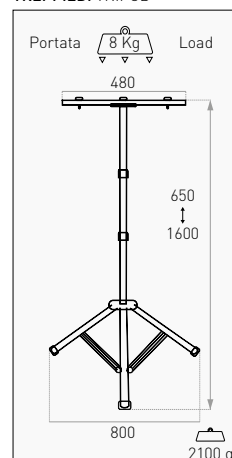

TRIPOD160	1/6	37,50 €
------------------	-----	---------



ADJUSTABLE METAL

Supporto da terra orientabile.
Struttura in metallo con impugnatura ergonomica.
Installazione facile e veloce.

Adjustable ground support. Metal structure with ergonomic handle.
Quick and easy installation.

Treppiedi in metallo ad elevata stabilità. Predisposto per 2 faretti.

High stability metal tripod.
Prepared for 2 spotlights.



08



 **PANNELLI**

NEW BACKLIGHT
ADVANCE
ACCESSORIES
DRIVER
INSTALLATION

 **TRACK LIGHT**

BINARY
REGIA SHOP 180
ACCESSORIES
CONNECTORS

 **STRIP**

ACCÈNTO PRO
NEW ACCÈNTO PRO IP67
ACCÈNTO PRO RGB+W
MAGIC
ACCÈNTO RGB+W
ACCÈNTO 230 V
ACCÈNTO
ACCESSORIES
DRIVER
NEW CONNECTORS
CONTROLLER

 **PROFILI**

INCASSO
CARTONGESSO
SUPERFICIE

 **PLAFONIERE LINEARI**

NEW SPEEDY
STABILA
SUPERLIGHT
PRIMA
SUPREMA ROUND
SUPREMA ROUND-V

 **TUBI**

FULL VISION+
FULL VISION

 **INDUSTRIAL**

NEW ATLAS
DISCOVERY MAX

PROFESSIONAL
PROFESSIONAL
PROFESSIONAL

SORGENTI

GO SMART

VERSATILI

INDOOR

OUTDOOR

SOLARI

WORK

PROFESSIONAL

ESPOSITORI



PANELS

PANNELLI

NEW

P-QUADRO

BACKLIGHT



1195 x 295 x 24 mm - 1500 g

30 X 120	SOURCE	OUTPUT									
40 W	5.190 lm	4.110 lm	CRI 80	4000 K	PQAB-421240	1/4	46,00 €				
			CRI 90	4000 K	PQAB90-421240	1/4	52,00 €				
220-240 V		IP20 ↓ IP43 ↑	120°	OPAL PMMA	FLICKER-FREE	DRIVER INCL.	<19 UGR	60.000 h	5 YEARS	CAM	ENEC 18



595 x 595 x 24 mm - 1260 g

60 X 60	SOURCE	OUTPUT									
40 W	5.190 lm	4.110 lm	CRI 80	3000 K	PQAB-426030	1/4	36,00 €				
				4000 K	PQAB-426040						
				6000 K	PQAB-426060						
			CRI 90	4000 K	PQAB90-426040	1/4	45,00 €				
220-240 V		IP20 ↓ IP43 ↑	120°	OPAL PMMA	FLICKER-FREE	DRIVER INCL.	<19 UGR	60.000 h	5 YEARS	CAM	ENEC 18

NO DRIVER	SOURCE	OUTPUT	DIFFUSER									
40 W	5.190 lm	4.110 lm	Prismatic	4000 K	PQABUN-426040	1/4	31,00 €					
			Opal	4000 K	PQABN-426040	1/4	26,00 €					
PQABN	33-40 V	IP20 ↓ IP43 ↑	120°	PMMA	FLICKER-FREE	DIMMABLE	NO DRIVER	<19 UGR	50.000 h	5 YEARS	CAM	ENEC 18

KIT DALI-2	SOURCE	OUTPUT	DIFFUSER									
40 W	5.190 lm	4.110 lm	Opal	4000 K	PQAB-426040D NEW	1/4	69,00 €					
PQAB	33-40 V	IP20 ↓ IP43 ↑	120°	PMMA	FLICKER-FREE	DIMMABLE DALI-2 / PUSH DIM	DRIVER INCL.	<19 UGR	50.000 h	5 YEARS	CAM	ENEC 18

OPTIONAL PAG. 192-193

ALIMENTATORI E ACCESSORI
POWER SUPPLIES AND ACCESSORIES

P-QUADRO
ADVANCE



595 x 595 x 10 mm - 1860 g

60 X 60		SOURCE	OUTPUT				
40 W	6.450 lm	4.300 lm	CRI 80	3000 K	PQA-426030	1/6	51,00 €
				4000 K	PQA-426040		
				6000 K	PQA-426060		
			CRI 90	3000 K	PQA90-426030	1/6	62,00 €
4000 K	PQA90-426040						

220-240 V IP20 ↓ 120° IP43 ↑ ULTRASLIM OPAL PMMA FLICKER-FREE DRIVER INCL. <19 UGR 60.000 h 5 YEARS CAM

NO DRIVER		SOURCE	OUTPUT				
40 W	6.450 lm	4.300 lm	CRI 80	4000 K	PQAN-426040	1/6	42,00 €
38 W	4.300 lm	3.900 lm	CRI 90	4000 K	PQAN90-426040	1/6	49,00 €

38-42 V IP20 ↓ 120° IP43 ↑ ULTRASLIM OPAL PMMA FLICKER-FREE DIMMABLE NO DRIVER <19 UGR 50.000 h 5 YEARS CAM



595 x 295 x 10 mm - 945 g

30 X 60		SOURCE	OUTPUT				
24 W	3.600 lm	2.400 lm		3000 K	PQA-243030	1/6	42,00 €
				4000 K	PQA-243040		

220-240 V IP20 ↓ 120° IP40 ↑ ULTRASLIM OPAL PMMA FLICKER-FREE DRIVER INCL. <19 UGR 60.000 h 5 YEARS CAM

30 X 120		SOURCE	OUTPUT				
40 W	6.450 lm	4.300 lm	CRI 80	3000 K	PQA-421230	1/6	64,00 €
				4000 K	PQA-421240		
38 W	4.300 lm	3.900 lm	CRI 90	3000 K	PQA90-421230	1/6	70,00 €
				4000 K	PQA90-421240		

220-240 V IP20 ↓ 120° IP40 ↑ ULTRASLIM OPAL PMMA FLICKER-FREE DRIVER INCL. <19 UGR 60.000 h 5 YEARS CAM

NO DRIVER		SOURCE	OUTPUT				
38 W	4.300 lm	3.900 lm	CRI 80	4000 K	PQAN-421240	1/6	49,00 €
			CRI 90	4000 K	PQAN90-421240	1/6	59,00 €

38-42 V IP20 ↓ 120° IP43 ↑ ULTRASLIM OPAL PMMA FLICKER-FREE DIMMABLE NO DRIVER <19 UGR 50.000 h 5 YEARS CAM



1195 x 595 x 10 mm - 4380 g

60 X 120		SOURCE	OUTPUT				
64 W	10.800 lm	8.320 lm	4000 K	PQA-646040	1/4	170,00 €	

220-240 V IP20 ↓ 120° IP40 ↑ ULTRASLIM OPAL PMMA FLICKER-FREE 2 DRIVER INCL. <19 UGR 50.000 h 5 YEARS CAM

OPTIONAL PAG. 192-193

ALIMENTATORI E ACCESSORI
POWER SUPPLIES AND ACCESSORIES

SORSENTI

GO SMART

VERSATILI

INDOOR

OUTDOOR

SOLARI

WORK

PROFESSIONAL

ESPOSITORI

ACCESSORIES
DRIVER

NOT DIMMABLE

IP20

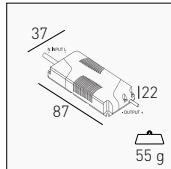

		INPUT	OUTPUT		
12 W	300 mA	220-240 V/AC	38 V/DC	RDPQ12	1/100 10,00 €

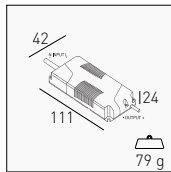

		INPUT	OUTPUT		
18 W	300 mA	220-240 V/AC	54 V/DC	RDPQ18	1/100 10,00 €
24 W	600 mA	220-240 V/AC	36 V/DC	RDPQ24	1/100 11,00 €
			24-42 V/DC	RDPQA24	1/50 13,50 €

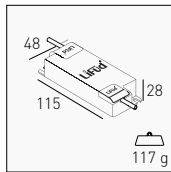

		INPUT	OUTPUT		
38 W	950 mA	220-240 V/AC	33-40 V/DC	RDPQA42	1/50 25,00 €
	1000 mA	220-240 V/AC	33-40 V/DC	RDPQA42120	1/100 20,00 €

5 YEARS

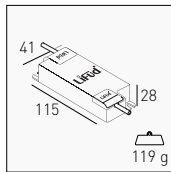

		INPUT	OUTPUT		
64 W	850 mA	220-240 V/AC	33-40 V/DC	RDPQA64	1/50 23,50 €

5 YEARS

DIMMABLE

IP20

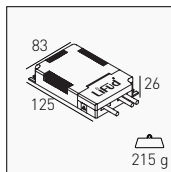

		INPUT	OUTPUT	PROTOCOL		
42 W	850-1050 mA (CC)	220-240 V/AC MAX 0.3 A	25-40 V/DC	1-10 V	DRIMPQ42	1/100 44,00 €

5 YEARS
DIMMABLE 1-10 V

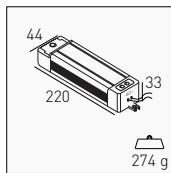

		INPUT	OUTPUT	PROTOCOL		
42 W	1050 mA	170-265 V/AC	30-44 V/DC	10% - 100%	DRIMPQ40	1/50 52,00 €

5 YEARS
DIMMABLE TRAILING EDGE

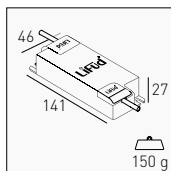

		INPUT	OUTPUT	PROTOCOL		
40 W	550-1050 mA	220-240 V/AC MAX 0.3 A	20-42 V/DC	DALI-2 / PUSH	DRIMPQ42D	1/50 38,00 €

5 YEARS
DIMMABLE DALI-2 / PUSH DIM

Multicorrente 550-1050 mA per alimentare diverse tipologie di apparecchi LED
550-1050 mA multi-current for different types of LED luminaires

T. N.

ACCESSORIES

INSTALLATION

KIT SOSPENSIONE SUSPENSION

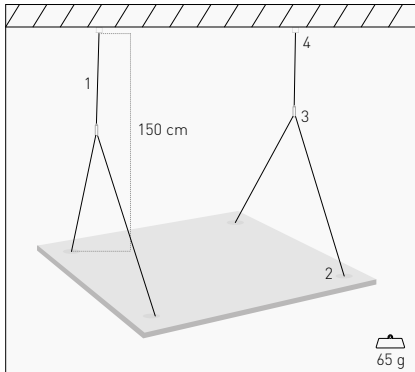

COMPATIBLE WITH

PQAUN - PQA 24 W / 38 W / 80 W	KIT-PQ40	1/100	10,00 €
--------------------------------	-----------------	-------	---------

INCLUDED

1. CAVI IN ACCIAIO STEEL CABLES

2. VITI PER FISSAGGIO AL PANNELLO SCREWS FOR FIXING TO THE PANEL

3. PASSACAVI AUTOCABLANTI SELF-WIRING CABLE GLANDS

4. FERMACAVI CON FILETTATURA PER STAFFA CABLE CLAMP WITH THREAD FOR BRACKET

KIT CLIP CARTONGESSO PLASTERBOARD



COMPATIBLE WITH

PQAUN - PQA 24 W / 38 W	KIT-CLIP	1/100	10,00 €
-------------------------	-----------------	-------	---------

STEEL

INSTALLATION

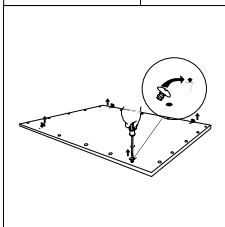

Svitare le viti evidenziate dai quattro angoli del pannello LED.

Unscrew the highlighted screws from the four corners of the LED Panel.

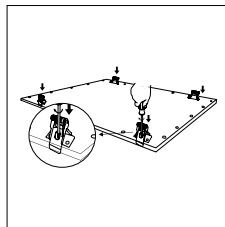

Posizionare le molle in posizione e reinstallare le quattro viti. (Le viti devono essere inserite attraverso il foro centrale della clip).

Place the springs in position and reinstall the four screws. (The screws must be inserted through the center hole of the clip).

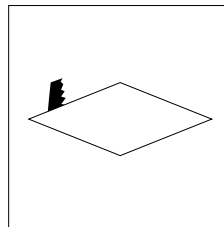

Tagliare un foro nel soffitto.

Cut a hole in the ceiling.

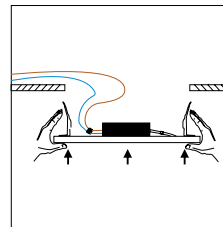

Collegare il LED Driver a corrente alternata di rete. Spingere il Pannello nella cavità del soffitto con le molle in rilievo.

Connect the LED Driver to AC mains power. Push the LED Panel into the ceiling cavity with the springs raised.

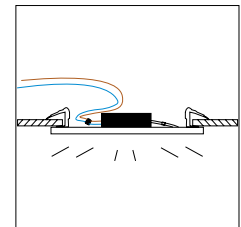

Installazione Completata.

Complete installation.

TECHNICAL NOTES

KIT DI FISSAGGIO IN ACCIAIO PER INSTALLAZIONI SPECIFICHE SU CARTONGESSO
STEEL FIXING KIT FOR SPECIFIC INSTALLATIONS ON PLASTERBOARD

BINARY

THREE-PHASE

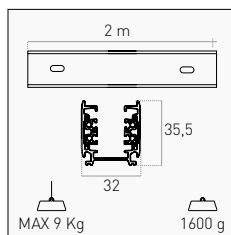

White <input type="checkbox"/>	BNRBI-2000	1/50	52,00 €
Black <input checked="" type="checkbox"/>	BNRNE-2000		

THREE-PHASE 220-240 V 10 A IP20 MAX ALUMINUM

Binario per l'installazione di faretti o sospensioni LED. Il sistema trifase permette fino a tre accensioni indipendenti. Può essere installato sia a parete che a soffitto e, in alternativa, anche a sospensione tramite KIT opzionale. Il sistema binario è completamente personalizzabile grazie agli accessori.

Track suitable for LED spotlights or suspensions installation. The three-phase system allows up to three independent ignitions. To be installed both on the wall and on the ceiling or suspended by an optional KIT. The track system is completely customizable thanks to the accessories.

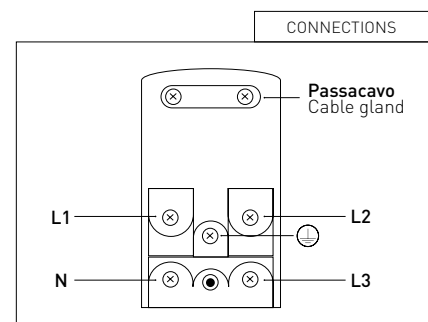

TRACK LIGHT REGIA SHOP 180

UGR<19 - CRI 90



SORSENTI

GO SMART

VERSATILI

INDOOR

OUTDOOR

SOLARI

WORK

PROFESSIONAL

ESPOSITORI

EUTRAC			
0-90° 0-350°			
	A	B	g
	mm	mm	g
20 W	Ø 70	265	640
35 W	Ø 88	273	850

SOURCE		OUTPUT					
20 W	1.800 lm	1.600 lm	White <input type="checkbox"/>	3000 K	RGT180BI-207030	1/6	57,50 €
				4000 K	RGT180BI-207040		
			Black <input type="checkbox"/>	3000 K	RGT180NE-207030		
				4000 K	RGT180NE-207040		
35 W	3.100 lm	2.800 lm	White <input type="checkbox"/>	3000 K	RGT180BI-359030	1/6	82,50 €
				4000 K	RGT180BI-359040		
			Black <input type="checkbox"/>	3000 K	RGT180NE-359030		
				4000 K	RGT180NE-359040		

EUTRAC 220-240 V IP20 45°

EASY TO INSTALL ALUMINUM <19 90 CRI

Apparecchio LED per binario Eutrac ad alte prestazioni. Il corpo snodabile permette di direzionare la luce in maniera ottimale.

Eutrac High performance LED luminaire. Jointed body for a focused and directional light.

TECHNICAL NOTES



RUOTABILE SU ASSE 350° - INCLINABILE 90°
ROTATABLE ON AXIS 350° - TILTABLE 90°

ACCESSORIES - TRACK LIGHT

CONNECTORS

ADATTATORE PER SOSPENSIONE / SUSPENSION ADAPTER

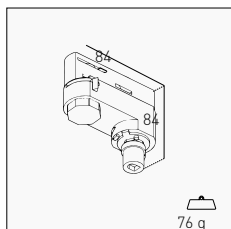

White <input type="checkbox"/>	ACBNRBI-AD	1/50	11,25 €
Black <input checked="" type="checkbox"/>	ACBNRNE-AD		

THREE-PHASE 220-240 V 10 A IP20
 MAX

SISTEMA A BINARIO LINEARE / LINEAR TRACK SYSTEM

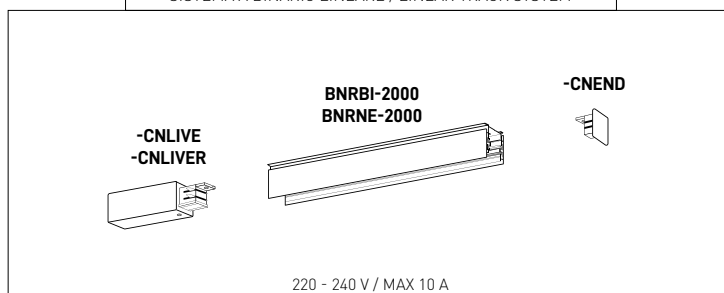

SISTEMA A BINARIO PERSONALIZZATO / CUSTOM TRACK SYSTEM

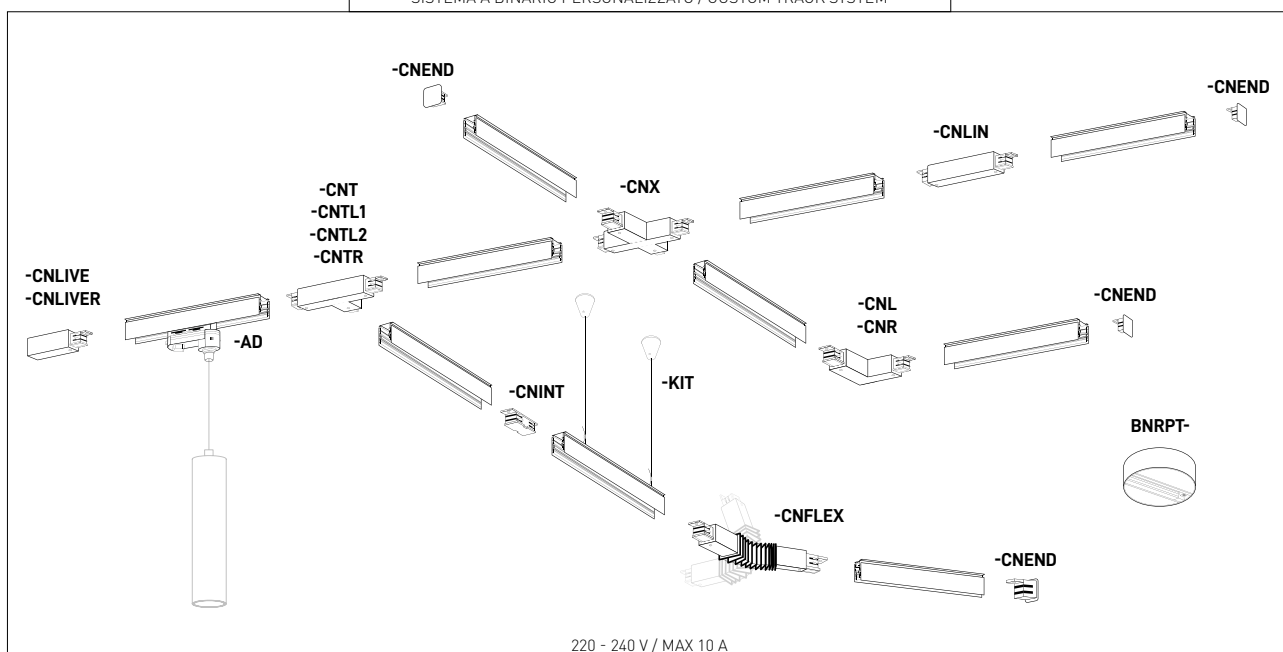

ALIMENTAZIONE SUPPLY

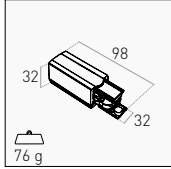

POWER

Sinistro / Left	White □	ACBNRBI-CNLIVE	1/50	6,70 €
	Black ■	ACBNRNE-CNLIVE		
Destro / Right	White □	ACBNRBI-CNLIVER	1/50	6,70 €
	Black ■	ACBNRNE-CNLIVER		

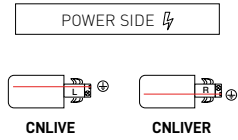

GIUNTO A T-JOINT

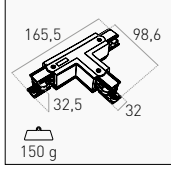

POWER

Destro - Sinistro / Left - Right	White □	ACBNRBI-CNT	1/40	19,90 €
	Black ■	ACBNRNE-CNT		
Sinistro - Destro / Right - Left	White □	ACBNRBI-CNTL1	1/25	21,25 €
	Black ■	ACBNRNE-CNTL1		
Sinistro - Sinistro / Left - Left	White □	ACBNRBI-CNTL2	1/25	
	Black ■	ACBNRNE-CNTL2		
Destro - Destro / Right - Right	White □	ACBNRBI-CNTR	1/25	
	Black ■	ACBNRNE-CNTR		

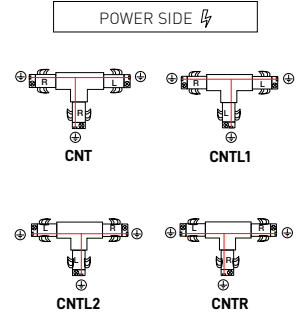

GIUNTO A L-JOINT

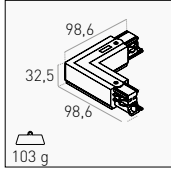

POWER

Sinistro / Left	White □	ACBNRBI-CNL	1/50	14,75 €
	Black ■	ACBNRNE-CNL		
Destro / Right	White □	ACBNRBI-CNR	1/25	14,75 €
	Black ■	ACBNRNE-CNR		

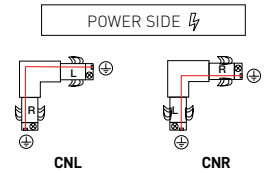

TERMINALE END CAP

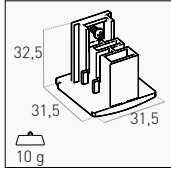

White □	ACBNRBI-CNEND	1/50	1,25 €
Black ■	ACBNRNE-CNEND		

GIUNTO LINEARE LINEAR JOINT

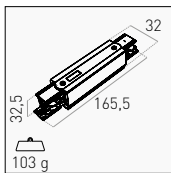

W □	ACBNRBI-CNLIN	1/50	14,75 €
B ■	ACBNRNE-CNLIN		



GIUNTO FLESSIBILE FLEXIBLE JOINT

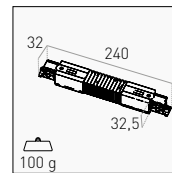

W □	ACBNRBI-CNFLEX	1/50	20,00 €
B ■	ACBNRNE-CNFLEX		



GIUNTO A X-X-JOINT

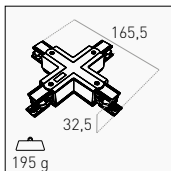

W □	ACBNRBI-CNX	1/50	21,25 €
B ■	ACBNRNE-CNX		



GIUNTO INTERNO (A SCOMPARSA) INTERNAL HIDDEN JOINT

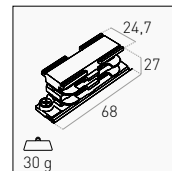

W □	ACBNRBI-CNINT	1/50	6,70 €
B ■	ACBNRNE-CNINT		

PLAFONIERA BINARIO BINARY CEILING

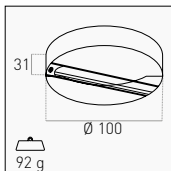

W □	BNRPT-BI	1/20	21,00 €
B ■	BNRPT-NE		

THREE-PHASE

KIT SOSPENSIONE 2 m SUSPENSION KIT 2 m

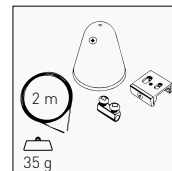

W □	ACBNRBI-KIT	1/50	6,20 €
B ■	ACBNRNE-KIT		



7 W/m - 10 W/m

14 W/m - 20 W/m

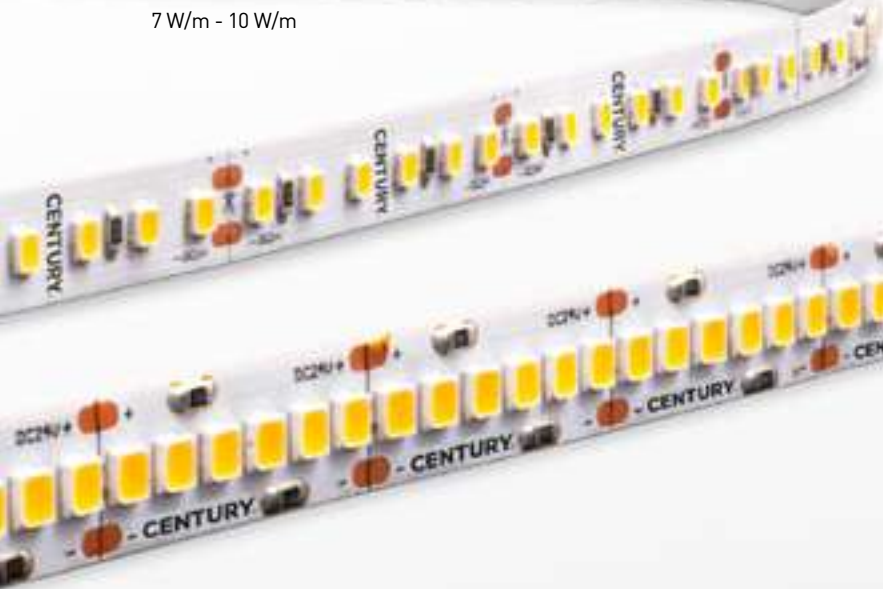

NEW
STRIP

ACCÈNTO PRO

NEW
STRIP
ACCÈNTO PRO



35 W	100	42
50 W	100	42
70 W	118	25
100 W	118	25

35 W (7 W/m)	4.025 lm (805 lm/m)	144 led/m	2700 K	AC95-0714427	10/20	33,75 €
			3000 K	AC95-0714430		
			4000 K	AC95-0714440		
			6000 K	AC95-0714460		
50 W (10 W/m)	5.750 lm (1.150 lm/m)	144 led/m	2700 K	AC95-1014427	10/20	40,00 €
			3000 K	AC95-1014430		
			4000 K	AC95-1014440		
			6000 K	AC95-1014460		
70 W (14 W/m)	8.050 lm (1.610 lm/m)	240 led/m	2700 K	AC95-1424027	10/20	47,50 €
			3000 K	AC95-1424030		
			4000 K	AC95-1424040		
			6000 K	AC95-1424060		
100 W (20 W/m)	12.000 lm (2.400 lm/m)	240 led/m	3000 K	AC95-2024030	10/20	57,50 €
			4000 K	AC95-2024040		
			6000 K	AC95-2024060 NEW		

24 V IP20 120° INDOOR 5 METERS

DIMMABLE 93 CRI 30.000 h 3 YEARS



Strisce LED professionali caratterizzate da una resa cromatica elevatissima, permettono di ottenere un'illuminazione fedele ai reali colori degli oggetti.

Professional LED strips with high color rendering, which allows to obtain a color-true lighting of the objects.



TECHNICAL NOTES



ELEVATA DENSITÀ DI LED PER METRO PER UN EFFETTO DI LUCE CONTINUA
HIGH DENSITY OF LEDS PER METER FOR A CONTINUOUS LIGHT EFFECT

OPTIONAL PAG. 208-209

ALIMENTATORI E ACCESSORI
POWER SUPPLIES AND ACCESSORIES

SORGENTI
GO SMART
VERSATILI
INDOOR
OUTDOOR
SOLARI
WORK
PROFESSIONAL
ESPOSITORI

NEW
STRIP
ACCÈNTO PRO

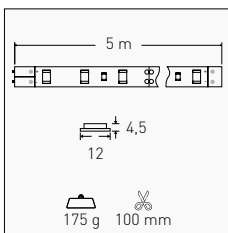

70 W (14 W/m)	7.700 lm (1.540 lm/m)	3000 K	AC9567-1414430 NEW	10/20	67,50 €				
		4000 K	AC9567-1414440 NEW						
24 V	IP67	120°	OUTDOOR	5 METERS	144 LED/m	DIMMABLE	93 CRI	30.000 h	3 YEARS

Striscia LED IP67 professionale progettata per offrire una tenuta ermetica, evitando l'ingresso di particelle di polvere dannose e consentendo la sua immersione temporanea senza compromettere le prestazioni.

Professional IP67 LED strip designed to provide a hermetic seal, preventing the entry of harmful dust particles and allowing temporary immersion without compromising performance.

INCLUDED

CLIP DI FISSAGGIO E TAPPO TERMINALE IN SILICONE
FIXING CLIP AND SILICONE END CAP

OPTIONAL PAG. 208-209

ALIMENTATORI E ACCESSORI
POWER SUPPLIES AND ACCESSORIES

STRIP
ACCÈNTO PRO

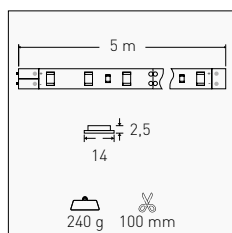

47,5W (9,5 W/m) 2.280 lm (456 lm/m)	RGB + 3000 K	ACRGBW-956030	10/20	89,00 €						
	RGB + 4000 K	ACRGBW-956040								
24 V	IP65	180°	OUTDOOR	5 METERS	60 LED/m	DIMMABLE	90 CRI (WHITE)	RGB+W	50.000 h	3 YEARS

TECHNICAL NOTES

LA STRIP LED RGB+W, A DIFFERENZA DELLE RGB, HA CHIP BIANCHI DEDICATI PER UN BIANCO PURO E COLORI PIÙ VIVACI. THE RGB+W LED STRIP, UNLIKE THE RGB, HAS SPECIFIC WHITE CHIPS FOR PURE WHITE AND BRIGHTER COLORS.



INCLUDED

CLIP DI FISSAGGIO E TAPPO TERMINALE IN SILICONE
FIXING CLIP AND SILICONE END CAP

OPTIONAL PAG. 208-209

ALIMENTATORI E ACCESSORI
POWER SUPPLIES AND ACCESSORIES

Striscia LED IP65 professionale progettata per offrire una tenuta ermetica, protetta contro l'ingresso di particelle di polvere dannose e getti d'acqua. Grazie alla sua funzionalità RGB e alla luce bianca aggiuntiva, è possibile creare un'ampia gamma di effetti luminosi personalizzati.

Professional IP65 LED strip designed to offer an airtight seal, protected against the entry of harmful dust particles and water jets. Thanks to its RGB functionality and additional white light, a wide range of customized lighting effects can be created.

STRIP MAGIC

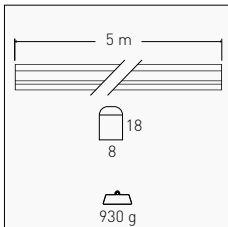

24 W (4,8 W/m)	RGB	MGR5-486010	1/6	72,00 €
220-240 V	IP67	180°	OUTDOOR	5 METERS
			60 LED/m	DIMMABLE
			RGB	40.000 h

INSTALLATION



Strip LED professionale RGB, protetta da polvere e getti d'acqua. Grazie al telecomando in dotazione è possibile gestire oltre mille giochi di luce dinamici.

RGB professional LED strip, dustproof and water resistant. Thanks to the supplied remote control it is possible to manage over a thousand dynamic light effects.

FOCUS

Struttura in silicone IP67 per la massima sicurezza e resa dei colori

IP67 silicone structure for maximum security and color rendering

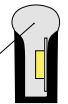

BLISTER KIT

MAGIC STRIP
Telecomando IR IR Remote
Alimentatore a spina Plug-in Power supply
Clip di fissaggio Fixing clip



TECHNICAL NOTES

TECNOLOGIA DI INSEGUIMENTO DEI COLORI, OGNI CHIP È PROGRAMMATO SINGOLARMENTE PER UN EFFETTO A "CASCATA" COLOR TRACKING TECHNOLOGY, EACH CHIP IS INDIVIDUALLY PROGRAMMED FOR A "WATERFALL" EFFECT.



STRIP
ACCENTO



SORSENTI

GO SMART

VERSATILI

INDOOR

OUTDOOR

SOLARI

WORK

PROFESSIONAL

ESPOSITORI

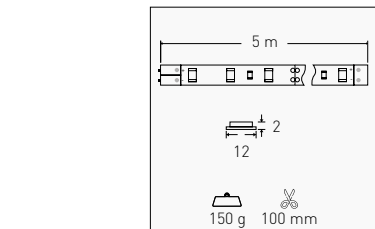

WHITE MODE

95 W (19 W/m)	8.500 lm (1.700 lm/m)	RGB + 4000 K	ACRGBW-196010	10/20	49,00 €
---------------	-----------------------	--------------	----------------------	-------	---------

4000 K	24 V	IP20	120°	INDOOR	5 METERS	120 LED/m	RGB+W	DIMMABLE	90 CRI (WHITE)	30.000 h	3 YEARS
--------	------	------	------	--------	----------	-----------	-------	----------	----------------	----------	---------

FOCUS

3M VHB EXTRA STRONG
Potere dissipante
Dissipation power

TECHNICAL NOTES

LA STRIP LED RGB+W, A DIFFERENZA DELLE RGB, HA CHIP BIANCHI DEDICATI PER UN BIANCO PURO E COLORI PIÙ VIVACI
THE RGB+W LED STRIP, UNLIKE THE RGB, HAS DEDICATED WHITE CHIPS FOR PURE WHITE AND BRIGHTER COLORS

OPTIONAL PAG. 208-209

ALIMENTATORI E ACCESSORI
POWER SUPPLIES AND ACCESSORIES

Striscia LED da interno RGB+W per trasformare la tua casa in un'opera d'arte luminosa. Esplora l'ampia gamma di colori vivaci e regola l'intensità della luce bianca per creare l'atmosfera perfetta per ogni occasione.

RGB+W indoor LED strip to transform your home into a luminous work of art. Explore the wide range of vibrant colors and adjust the intensity of the white light to create the perfect mood for any occasion.



STRIP
ACCÈNTO 230 V



Facile installazione
Easy installation



Collegamento alla rete
Network connection



Alimentatore non richiesto
No power supply required



Senza cali di tensione
Without voltage drops



Illuminazione uniforme
Uniform lighting



Taglio ogni 10 cm
10 cm cuttable

Disponibile in bobine da / Available in reels of
5 m - 20 m

STRIP ACCÈNTO 230 V

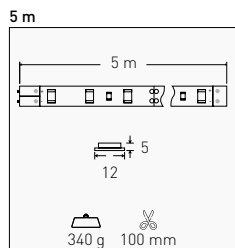

70 W (14 W/m) 7.400 lm (1.480 lm/m)	3000 K	AC5230-1512030	10/20	135,00 €
	4000 K	AC5230-1512040		

220-240 V IP65 120° OUTDOOR 5 METERS EASY TO INSTALL NO DRIVER LED/m DIMMABLE 50.000 h

CONFEZIONATA IN BUSTA TERMICA
PACKED IN THERMAL BAG N.B.

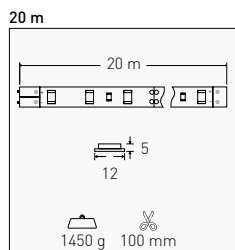

280 W (14 W/m) 29.600 lm (1.480 lm/m)	3000 K	AC20230-1512030	1/4	540,00 €
	4000 K	AC20230-1512040		

220-240 V IP65 120° OUTDOOR 20 METERS EASY TO INSTALL NO DRIVER LED/m DIMMABLE 50.000 h

CONFEZIONATA IN BOBINA INDUSTRIALE
PACKED IN INDUSTRIAL REEL N.B.

INCLUDED

CLIP DI FISSAGGIO E TAPPO TERMINALE IN SILICONE
FIXING CLIP AND SILICONE END CAP

OPTIONAL



Kit start 230 V - Silicone	KIT-STARTAC230	5,00 €
Fixing clip - 10 pz	KIT-CLIPAC230	2,20 €
End cap IP65 - 5 pz	KIT-ENDCAPS	2,00 €

INSTALLATION



Strip LED professionale alimentata direttamente a 230 V (No driver), con guaina protettiva in silicone e nastro adesivo 3M. Sezionabile ogni 10 cm.

Professional LED strip powered directly at 230 V (No driver), with protective silicone sheath and 3M adhesive tape. Sectionable every 10 cm.



IDEALE PER LE INSTALLAZIONI CON COLLEGAMENTO DIRETTO ALLA RETE
IDEAL FOR INSTALLATIONS WITH DIRECT CONNECTION TO THE NETWORK

STRIP
ACCÈNTO



	A	g	mm
35 W	8	71	165
70 W	10	290	100

35 W (7 W/m) 3.500 lm (700 lm/m) 30 led/m	3000 K	AC2-722430	10/20	22,00 €
	4000 K	AC2-722440		
	6000 K	AC2-722460		
70 W (14 W/m) 7.000 lm (1.400 lm/m) 60 led/m	3000 K	AC2-142430	10/20	27,00 €
	4000 K	AC2-142440		
	6000 K	AC2-142460		

24 V
 IP20
 120°
 INDOOR
 5 METERS

DIMMABLE
 EASY TO INSTALL

Striscia LED da interno progettate con la massima attenzione ai dettagli e alle prestazioni.

Indoor LED strip designed with the utmost attention to detail and performance.

FOCUS

3M 300LSE
EXTRA STRONG
Facile installazione
Easy installation

OPTIONAL PAG. 208-209

ALIMENTATORI E ACCESSORI
POWER SUPPLIES AND ACCESSORIES

STRIP
ACCENTO

BLISTER



SORGENTI

GO SMART

VERSATILI

INDOOR

OUTDOOR

SOLARI

WORK

PROFESSIONAL

ESPOSITORI

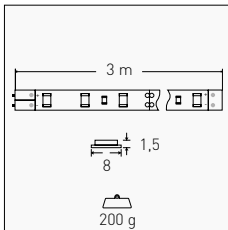

14,4 W (4,8 W/m)	1.260 lm (420 lm/m)	3000 K	ACBL-486030	10/20	33,00 €
		6000 K	ACBL-486060		
	-	RGB	ACRBL-486010	10/20	43,00 €

100-240 V
 IP20
 120°
 INDOOR
 3 METERS
 EASY TO INSTALL
 30 LED/m
 RGB ACRBL
 ACRBL DIMMABLE
 50.000 h

FOCUS

3M 300LSE
EXTRA STRONG
Facile installazione
Easy installation

BLISTER KIT

Strip LED
Alimentatore a spina Plug-in Power supply
Telecomando IR IR Remote (Only ACRBL)

Strip LED da interno in kit pronto all'uso con strip e alimentatore per un rapido utilizzo.

Indoor LED strip in ready-to-use kit with strip and power supply for quick use.

ACCESSORIES
DRIVER

IP20

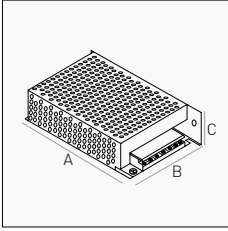

		A	B	C					
40 W	1500 mA	110 mm	77 mm	35 mm	186 g	RDAC35-24	1/100	16,50 €	
60 W	2500 mA	110 mm	77 mm	35 mm	186 g	RDAC60-24	1/100	22,50 €	
100 W	4200 mA	160 mm	99 mm	43 mm	312 g	RDAC100-24	1/50	30,00 €	
120 W	5000 mA	200 mm	99 mm	43 mm	430 g	RDAC120-24	1/50	32,50 €	
150 W	6500 mA	200 mm	99 mm	43 mm	590 g	RDAC150-24	1/50	35,00 €	
200 W	8300 mA	200 mm	110 mm	50 mm	590 g	RDAC200-24	1/36	45,00 €	

IP20 INPUT 100-240 V OUTPUT 24 V

IP67

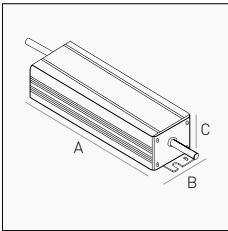

		DIMMABLE	A	B	C			
50 W	2100 mA	No	205 mm	35 mm	24 mm	266 g	RDAC50-2467	1/50 37,50 €
60 W	2500 mA	1-10 V	170 mm	50 mm	32 mm	450 g	RDAC60-2467D	1/20 77,50 €
		No	182 mm	62 mm	20 mm	380 g	RDAC100-2467	1/30 60,00 €
100 W	4200 mA	1-10 V	182 mm	62 mm	20 mm	380 g	RDAC100-2467D	1/30 124,00 €
		No	238 mm	58 mm	32 mm	800 g	RDAC150-2467D	1/15 142,50 €
150 W	6250 mA	1-10 V	238 mm	58 mm	32 mm	800 g	RDAC150-2467D	1/15 142,50 €
200 W	8300 mA	No	238 mm	58 mm	32 mm	760 g	RDAC200-2467	1/100 90,00 €
250 W	10.500 mA	1-10 V	248 mm	72 mm	32 mm	1000 g	RDAC250-2467D	1/15 177,50 €
300 W	12.500 mA	No	228 mm	72 mm	32 mm	1000 g	RDAC300-2467	1/100 120,00 €

IP67 INPUT 175-264 V OUTPUT 24 V DIMMABLE 1-10 V



NEW

ACCESSORIES

CONNECTORS

LINEARE
PLASTIC BAG 2 pz

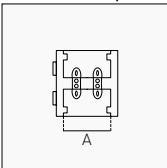

A	COMPATIBILITY		
8 mm	AC	ACCN8	1,00 €
10 mm	AC	ACCN10	1,50 €
	AC95	ACCN95 NEW	1,00 €

1/100

T
PLASTIC BAG 2 pz

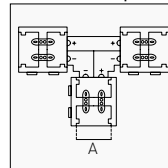

A	COMPATIBILITY		
8 mm	AC	ACCN8T	4,00 €
10 mm	AC	ACCN10T	4,50 €
	AC95	ACCN95T NEW	4,00 €

1/100

LINEARE CON CAVO
PLASTIC BAG 2 pz

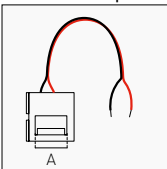

A	COMPATIBILITY		
8 mm	AC	ACCN8WIRE	1,50 €
10 mm	AC	ACCN10WIRE	1,50 €
	AC95	ACCN95WIRE NEW	1,50 €

15 cm 1/100

ANGOLARI A L
PLASTIC BAG 2 pz

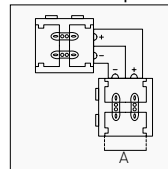

A	COMPATIBILITY		
8 mm	AC	ACCN8ANG	3,00 €
10 mm	AC	ACCN10ANG	3,00 €
	AC95	ACCN95ANG NEW	3,00 €

1/100

LINEARI CON CAVO
PLASTIC BAG 2 pz

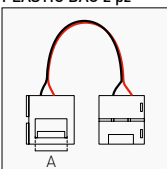

A	COMPATIBILITY		
8 mm	AC	ACCN8WIRE2	2,00 €
10 mm	AC	ACCN10WIRE2	2,00 €
	AC95	ACCN95WIRE2 NEW	2,00 €

15 cm 1/100

X
PLASTIC BAG 2 pz

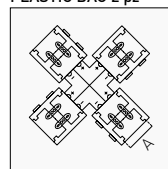

A	COMPATIBILITY		
8 mm	AC	ACCN8X	5,00 €
10 mm	AC	ACCN10X	5,00 €
	AC95	ACCN95X NEW	5,00 €

1/100



ACCESSORIES

CONTROLLER

TOUCH REMOTE RF

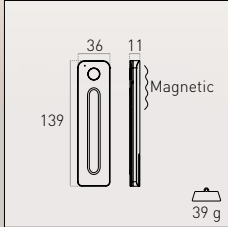

OUTPUT	BATTERY			
RF [2.4 GHz]	1x CR2032	CTRLF	1/100	42,00 €

IP20 30 meters MAX DISTANCE 0-100% TOUCH SLIDE MAGNETIC 5 YEARS

TECHNICAL NOTES

TELECOMANDO RF TOUCH SLIDE CON SUPPORTO A PARETE MAGNETICO
RF TOUCH SLIDE REMOTE CONTROL WITH MAGNETIC WALL SUPPORT



SORGENTI

GO SMART

VERSATILI

DIMMER SINGLE COLOR

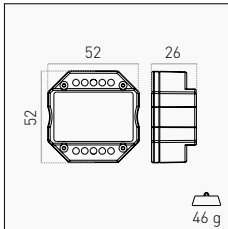

OUTPUT	PROTOCOL			
POWER 192 W / 24 V	0-100%+PUSH	DIM-PWM	1/100	43,00 €

IP20 IN/OUT 12-48 V DIMMABLE 0%-100% + PUSH DIM 4096 STEP 0-100% 5 YEARS

TECHNICAL NOTES

MONTAGGIO TIPICO A PARETE CON SCATOLA DI GIUNZIONE
TYPICAL WALL MOUNT WITH JUNCTION BOX



INDOOR

OUTDOOR

DIMMER SINGLE COLOR

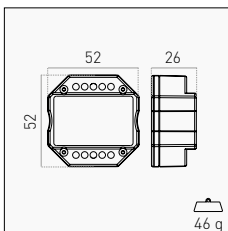

OUTPUT	PROTOCOL			
SIGNAL 0/1-10 V (20 mA)	0/1-10 V + PUSH	DIM-010	1/100	52,00 €

IP20 IN/OUT 100-240 V DIMMABLE 0/1-10 V + PUSH DIM 256 STEP 0-100% 5 YEARS

TECHNICAL NOTES

MONTAGGIO TIPICO A PARETE CON SCATOLA DI GIUNZIONE
TYPICAL WALL MOUNT WITH JUNCTION BOX



SOLARI

CONTROLLER RGB+W WI-FI

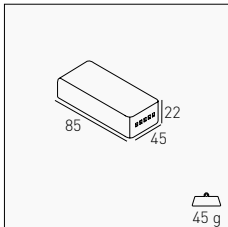

CARICO MASSIMO / MAXIMUM LOAD			
5 A x 4 Channel = 20 A / Max 120 W	CTLSMA-ACRGBW	10/180	32,50 €

IP20 IN/OUT 12-24 V 2,4 GHz WI-FI **RGB+W**



WORK

KIT CONTROLLER RGB+W + TOUCH REMOTE

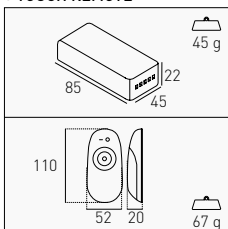

CARICO MASSIMO / MAXIMUM LOAD			
6 A x 4 Channel = 24 A / Max 120 W	KIT-ACRGBW	1/100	36,00 €

IP20 IN/OUT 12-24 V 2,4 GHz REMOTE RF **RGB+W** 30 meters MAX DISTANCE 20 PROGRAMS



PROFESSIONAL

ESPOSITORI

PROFILI IN ALLUMINIO

PROFILI PROFILE



INCASSO RECESSED

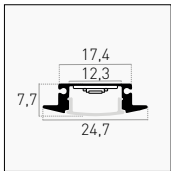

OPTIONAL

Aluminum <input checked="" type="checkbox"/>	KPRI-2508	1/20	25,00 €
White <input type="checkbox"/>	KPRI-2508B	1/20	34,00 €
Black <input checked="" type="checkbox"/>	KPRI-2508N		

IP20 2 m KIT 12,3 mm SPACE FOR STRIP 15 W/m DISSIPATION ALUMINUM 5 YEARS

INCLUDED

OPAL COVER CAPS CLIPS

Cover 1 pz	Opal Black <input checked="" type="checkbox"/>	PRCN-2508N	1/20	12,00 €
	Transparent <input type="checkbox"/>	PRCV-2508	1/20	4,00 €
	Opal <input type="checkbox"/>	PRCO-2508	1/20	5,00 €
Cap 5 pz	-	KPRI-2508-CAP	1/100	2,20 €
	Forati With hole	KPRI-2508-CAPH	1/100	2,50 €
Clip 10 pz	Fissaggio Fixing	KPRI-2508-CLIP	1/100	4,00 €

CARTONGESSO PLASTERBOARD

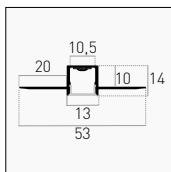

FOCUS

Packaging tubolare protettivo
Protective tubular packaging



OPTIONAL

Aluminum <input checked="" type="checkbox"/>	KPRCG-5314	1/20	60,00 €
--	-------------------	------	---------

IP20 3 m KIT 10,5 mm SPACE FOR STRIP 15 W/m DISSIPATION ALUMINUM 5 YEARS

INCLUDED

OPAL COVER CAPS

Cover 1 pz	Opal <input type="checkbox"/>	PRCO-5314	1/20	6,00 €
Cap 5 pz	-	KPRCG-5314-CAP	1/100	2,50 €
	Forati With hole	KPRCG-5314-CAPH		

SUPERFICIE SURFACE

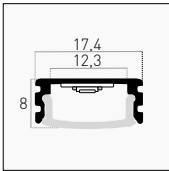

OPTIONAL

Aluminum	<input checked="" type="checkbox"/>	KPRS-1708	1/20	15,00 €
White	<input type="checkbox"/>	KPRS-1708B	1/20	20,00 €
Black	<input checked="" type="checkbox"/>	KPRS-1708N	1/20	25,00 €

IP20 2 m KIT 12,3 mm SPACE FOR STRIP 15 W/m DISSIPATION ALUMINUM 5 YEARS

INCLUDED

OPAL COVER CAPS CLIPS

Cover 1 pz	Opal Black	<input checked="" type="checkbox"/>	PRCN-1708N	1/20	12,00 €
	Transparent	<input type="checkbox"/>	PRCV-1708	1/20	5,50 €
	Opal	<input type="checkbox"/>	PRCO-1708	1/20	5,00 €
Cap 5 pz	-		KPRS-1708-CAP	1/100	2,20 €
	Forati With hole		KPRS-1708-CAPH	1/100	2,50 €
Clip 10 pz	Fissaggio Fixing		KPRS-1708-CLIP	1/100	4,00 €

BOMBATA ROUNDED

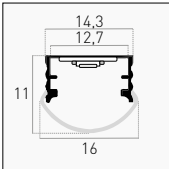

OPTIONAL

Aluminum	<input checked="" type="checkbox"/>	KPRS-1611	1/20	15,50 €
White	<input type="checkbox"/>	KPRS-1611B	1/20	21,00 €
Black	<input checked="" type="checkbox"/>	KPRS-1611N		

IP20 2 m KIT 12,7 mm SPACE FOR STRIP 15 W/m DISSIPATION ALUMINUM 5 YEARS

INCLUDED

OPAL COVER CAPS CLIPS

Cover 1 pz	Opal Black	<input checked="" type="checkbox"/>	PRCN-1611N	1/20	11,00 €
	Opal	<input type="checkbox"/>	PRCO-1611	1/20	5,00 €
Cap 5 pz	-		KPRS-1611-CAP	1/100	2,20 €
	Forati With hole		KPRS-1611-CAPH	1/100	2,50 €
Clip 10 pz	Fissaggio Fixing		KPRS-1611-CLIP	1/100	4,00 €

ANGOLARE ANGULAR

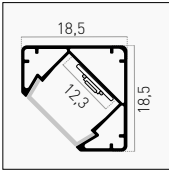

OPTIONAL

Aluminum	<input checked="" type="checkbox"/>	KPRAN-1818	1/20	20,00 €
White	<input type="checkbox"/>	KPRAN-1818B	1/20	24,50 €
Black	<input checked="" type="checkbox"/>	KPRAN-1818N	1/20	37,50 €

IP20 2 m KIT 12,3 mm SPACE FOR STRIP 15 W/m DISSIPATION ALUMINUM 5 YEARS

INCLUDED

OPAL COVER CAPS CLIPS

Cover 1 pz	Opal Black	<input checked="" type="checkbox"/>	PRCN-1818N	1/20	11,00 €
	Transparent	<input type="checkbox"/>	PRCV-1818	1/20	5,50 €
	Opal	<input type="checkbox"/>	PRCO-1818	1/20	5,00 €
Cap 5 pz	-		KPRAN-1818-CAP	1/100	2,20 €
	Forati With hole		KPRAN-1818-CAPH	1/100	2,50 €
Clip 10 pz	Fissaggio Fixing		KPRAN-1818-CLIP	1/100	4,00 €

Profili in alluminio per strisce LED. Assicurano un'installazione professionale e una distribuzione uniforme della luce. Il kit include una cover bianca opale e accessori di montaggio.

Aluminum profiles for LED strips. They ensure a professional installation and uniform light distribution. The kit includes an opal white cover and mounting accessories.

NEW
PLAFONIERA LINEARE
SPEEDY

TRICOLOR
3000K
4000K
6500K



	A mm	g	Max
4 W	313	68	25 pz
8 W	573	106	12 pz
10 W	873	142	10 pz
14 W	1173	186	7 pz
18 W	1478	355	5 pz

OUTPUT					
4 W	400 lm	3000 K - 4000 K - 6500 K	SPD-043000	6/24	13,75 €
8 W	800 lm	3000 K - 4000 K - 6500 K	SPD-086000	6/24	18,00 €
10 W	1.000 lm	3000 K - 4000 K - 6500 K	SPD-109000 NEW	6/24	23,50 €
14 W	1.400 lm	3000 K - 4000 K - 6500 K	SPD-141200 NEW	6/24	27,25 €
18 W	1.850 lm	3000 K - 4000 K - 6500 K	SPD-181500	6/24	36,25 €

200-240 V IP20 120°

CONNECTABLE EASY TO INSTALL CCT TRICOLOR

OPTIONAL

CAVETTO DI RACCORDO FLESSIBILE
FLEXIBLE CONNECTION CABLE

RC-SPD	6/100	3,00 €
---------------	-------	--------

INCLUDED

CAVO DA 1,5 METRI CON SPINA
1.5 METER CABLE WITH PLUG

CLIP DI FISSAGGIO
FIXING CLIPS

TECHNICAL NOTES



REGOLAZIONE DEL COLORE LUCE TRAMITE SELETTORE
COLOR TEMPERATURE ADJUSTMENT THROUGH SWITCH

Plafoniera innestabile l'una nell'altra a filo continuo. Luce funzionale di alta qualità.

Linkable ceiling light.
Functional high quality fixture.

PLAFONIERA LINEARE
STABILA



SORGENTI

GO SMART

VERSATILI

INDOOR

OUTDOOR

SOLARI

WORK

PROFESSIONAL

ESPOSITORI

	A mm	g
19 W	600	367
36 W	1200	578
45 W	1500	783
60 W	1500	783

	SOURCE	OUTPUT				
19 W	2.300 lm	2.090 lm	3000 K	STB-186030	1/6	18,50 €
			4000 K	STB-186040		
36 W	4.400 lm	4.220 lm	3000 K	STB-361230	1/6	26,00 €
			4000 K	STB-361240		
45 W	5.780 lm	5.050 lm	3000 K	STB-451530	1/6	32,00 €
			4000 K	STB-451540		
60 W	7.290 lm	7.000 lm	4000 K	STB-601540	1/6	49,00 €

220-240 V
 IP20
 120°
 3-in-1
 EASY TO INSTALL
 PC DIFFUSER
 ALUMINUM

Plafoniera versatile ed elegante, caratterizzata da un corpo in alluminio di alta qualità. La sua installazione è semplice e può essere montata a soffitto, a parete o sospesa grazie all'opzionale kit di sospensione. Aggiunge un tocco di stile e illuminazione efficace a qualsiasi ambiente.

Versatile and elegant ceiling light, characterized by a high-quality aluminum body. Its installation is simple and can be mounted on the ceiling, on the wall, or suspended using the optional suspension kit. It adds a touch of style and effective illumination to any environment.

INCLUDED



KIT INSTALLAZIONE A SOFFITTO O A PARETE
CEILING OR WALL INSTALLATION KIT

OPTIONAL PAG. 193



KIT INSTALLAZIONE A SOSPENSIONE
SUSPENSION INSTALLATION KIT

KIT-PQ40	1/100	10,00 €
-----------------	-------	---------

PLAFONIERA STAGNA
SUPERLIGHT



	A mm	 g
18 W	625	180
24 W	1150	300
36 W	1525	400

	SOURCE		OUTPUT				
18 W	1.900 lm	1.800 lm	4000 K		SPL65-186040	1/25	21,20 €
24 W	2.500 lm	2.400 lm	4000 K		SPL65-241240	1/25	26,00 €
36 W	3.900 lm	3.600 lm	4000 K		SPL65-361540	1/25	35,00 €

220-240 V IP65 IK06 120°

ULTRASLIM EASY TO INSTALL

Plafoniera IP65 con LED integrato dal design compatto, ideale per ambienti interni ed esterni.

Compact design IP65 ceiling light with integrated LED, for indoor and outdoor ambience.

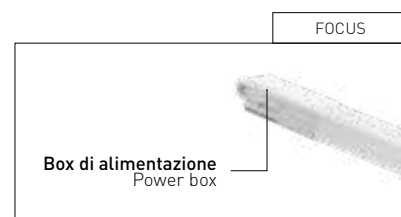

INCLUDED

KIT INSTALLAZIONE A SOFFITTO
CEILING INSTALLATION KIT

PLAFONIERA STAGNA

PRIMA



SORGENTI

GO SMART

VERSATILI

INDOOR

OUTDOOR

SOLARI

WORK

PROFESSIONAL

ESPOSITORI

	A mm	g
30 W	630	300
50 W	1230	500
70 W	1530	600

OUTPUT					
30 W	3.200 lm	4000 K	PRM-306040	1/10	34,50 €
50 W	5.400 lm	4000 K	PRM-501240	1/10	44,50 €
70 W	7.600 lm	4000 K	PRM-701540	1/10	57,00 €

220-240 V
 IP65
 IK06
 120°
 CONNECTABLE
 2-in-1 INSTALLATION
 EASY TO INSTALL
 50.000 h

INCLUDED



KIT INSTALLAZIONE A SOFFITTO
CEILING INSTALLATION KIT

OPTIONAL PAG. 193



KIT INSTALLAZIONE A SOSPENSIONE
SUSPENSION INSTALLATION KIT

KIT-PQ40	1/100	10,00 €
----------	-------	---------

SERIES INSTALLATION



PREDISPOSIZIONE PER INSTALLAZIONE IN SERIE, MAX 200 W
SUITABLE FOR SERIES INSTALLATION, MAX 200 W

30 W	50 W	70 W
6 pz	4 pz	3 pz

Plafoniera IP65 con LED integrato dal design compatto, ideale per ambienti interni ed esterni.

Compact design IP65 ceiling light with integrated LED, for indoor and outdoor ambience.

PLAFONIERA STAGNA
SUPREMA ROUND

IP65 - TUBE INCLUDED



	A mm	B mm	g g
9 W	665	69	630
18 W	1260	69	1200
36 W	1260	110	1860
48 W	1560	110	2400

TUBE INCLUDED	SOURCE					
1	9 W	900 lm	4000 K	SPPR-106040	1/10	24,50 €
	18 W	1.800 lm	4000 K	SPPR-181240	1/10	32,00 €
2	36 W	3.600 lm	4000 K	SPPR-361240	1/10	47,00 €
	48 W	5.000 lm	4000 K	SPPR-481540	1/6	60,00 €

170-250 V IP65 IK05 120°

TUBE INCLUDED EASY TO INSTALL

Plafoniera IP65 con tubi LED inclusi. Cablaggio con possibilità di derivazione linea interna, valida sostituta delle plafoniere stagne tradizionali.

IP65 ceiling light with LED tubes included. Wiring with the possibility of shunting an internal line, suitable for relamping of traditional watertight ceiling lights.

TECHNICAL NOTES

PREDISPOSIZIONE PER CONNESSIONE IN SERIE
 SUITABLE FOR SERIES CONNECTION

INCLUDED

TUBI LED SOSTITUIBILI
 REPLACEABLE LED TUBES

ACCESSORI DI FISSAGGIO E PASSACAPO
 FIXING ACCESSORIES AND CABLE GLAND

PLAFONIERA STAGNA
SUPREMA ROUND-V

IP65 - VUOTA/EMPTY



SORGENTI

GO SMART

VERSATILI

INDOOR

OUTDOOR

SOLARI

WORK

PROFESSIONAL

ESPOSITORI

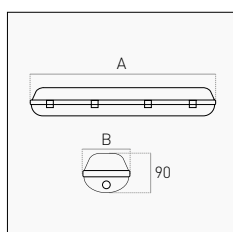

TUBE SLOT	A	B				
1	665 mm	69 mm	510 g	SPPRV-106000	1/10	14,75 €
	1260 mm	69 mm	870 g	SPPRV-181200	1/10	20,00 €
	1560 mm	69 mm	1500 g	SPPRV-241500	1/6	17,50 €
2	665 mm	110 mm	610 g	SPPRV-206000	1/10	27,50 €
	1260 mm	110 mm	1180 g	SPPRV-361200	1/10	26,00 €
	1560 mm	110 mm	1650 g	SPPRV-481500	1/6	34,50 €

170-250 V IP65 IK05 120°

NO TUBE EASY TO INSTALL

REQUIRED

TUBI LED SOSTITUIBILI NON INCLUSI
REPLACEABLE LED TUBES NOT INCLUDED

TECHNICAL NOTES

PREDISPOSIZIONE PER CONNESSIONE IN SERIE
SUITABLE FOR SERIES CONNECTION

Plafoniera stagna IP65 per tubi Led T8 con alimentazione da singolo lato, cablaggio con possibilità di derivazione linea interna.

IP65 watertight ceiling light for T8 Led tubes with single-ended power supply, internal line derivation wiring optional.

WIRING DIAGRAMS

Cablaggio doppio tubo interno 230 V/AC
Internal double tube wiring

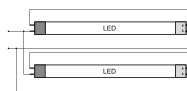

INCLUDED

ACCESSORI DI FISSAGGIO E PASSACAPO
FIXING ACCESSORIES AND CABLE GLAND

TUBI LED
FULL VISION +

160
lm/W

HIGH EFFICIENCY



FULL VISION + 160 lm/W

	A mm	g
9 W	600	96
18 W	1200	176
22 W	1500	210

G13	OUTPUT		Code	Pcs	Price
	W	lm			
9 W	1.440	4000 K	FVT8M160-096040	25	6,00 €
		6500 K	FVT8M160-096065		
18 W	2.880	4000 K	FVT8M160-181240	25	8,50 €
		6500 K	FVT8M160-181265		
22 W	3.520	4000 K	FVT8M160-221540	25	9,90 €
		6500 K	FVT8M160-221565		

220-240 V IP20 270°

OPAL GLASS 160 lm/W

WIRING DIAGRAMS



WIRING DIAGRAMS



RELAMPING

Spegnere la Rete.
Turn off the mains.

Rimuovere tutti i tubi fluorescenti esistenti.
Remove all fluorescent tubes.

Rimuovere gli starter e installare quello in dotazione.
Remove the starter and install the supplied one.

Installare FULL VISION +
Install FULL VISION +

Ripristinare la Rete
Turn on the mains.

Tubo LED idoneo per plafoniere con parabola riflettente. Struttura in vetro opale per un fascio luminoso omogeneo. Alta Efficienza 160 lm/W.

LED tube suitable for ceiling lights with reflector. Opal glass structure for a homogeneous light beam. 160 lm/W high efficiency.

INDUSTRIAL PACK

DISTRIBUITI IN CONFEZIONE INDUSTRIALE DA 25 PZ CON FOAM PROTETTIVO
DISTRIBUTED IN 25 PCS INDUSTRIAL PACK WITH PROTECTIVE FOAM



TUBI LED
FULL VISION



SINGLE BOX

	A mm	g
9 W	600	110
14 W	900	158
18 W	1200	211
22 W	1500	259

Φ G13	W	lm	OUTPUT		1/25	€	
			Color	Model			
9 W	1.000	lm	4000 K	FVT8-096040	1/25	5,50 €	
			6500 K	FVT8-096065			
14 W	1.540	lm	4000 K	FVT8-149040	1/25	8,50 €	
			6500 K	FVT8-149065			
18 W	2.000	lm	3000 K	FVT8-181230	1/25	7,30 €	
			4000 K	FVT8-181240			
	22 W	2.420	lm	6500 K	FVT8-181265	1/25	9,90 €
				3000 K	FVT8-221530		
				4000 K	FVT8-221540		
				6500 K	FVT8-221565		

220-240 V IP20 270°

OPAL GLASS

BOX

DISTRIBUITI IN SCATOLE DA 25 PZ CON PACKAGING IN CARTONE
DISTRIBUTED IN 25 PCS BOX WITH CARDBOARD PACKAGING



INDUSTRIAL PACK

	A mm	g
9 W	600	110
18 W	1200	211
22 W	1500	259

Φ G13	W	lm	OUTPUT		25	€
			Color	Model		
9 W	1.000	lm	4000 K	FVT8M-096040	25	4,50 €
			6500 K	FVT8M-096065		
18 W	2.000	lm	4000 K	FVT8M-181240	25	6,20 €
			6500 K	FVT8M-181265		
22 W	2.420	lm	4000 K	FVT8M-221540	25	7,80 €
			6500 K	FVT8M-221565		

220-240 V IP20 270°

OPAL GLASS

INDUSTRIAL PACK

Tubo LED idoneo per plafoniere con parabola riflettente. Struttura in vetro opale per un fascio luminoso omogeneo.

LED tube suitable for ceiling lights with reflector. Opal glass structure for a homogeneous light beam.

DISTRIBUITI IN CONFEZIONE INDUSTRIALE DA 25 PZ CON FOAM PROTETTIVO
DISTRIBUTED IN 25 PCS INDUSTRIAL PACK WITH PROTECTIVE FOAM



SORGENTI

GO SMART

VERSATILI

INDOOR

OUTDOOR

SOLARI

WORK

PROFESSIONAL

ESPOSITORI



NEW

SOSPENSIONE INDUSTRIALE
ATLAS



SORGENTI

GO SMART

VERSATILI

INDOOR



OUTDOOR

SOLARI

WORK

PROFESSIONAL

ESPOSITORI

NEW
SOSPENSIONE INDUSTRIALE

ATLAS

IP65 - MULTILIGHT - DIMMABLE



ATLAS è la sospensione industriale all-in-one, in alluminio, progettata per la massima versatilità e potenza. Disponibile nelle versioni Multilight (dimmerabile 0-10 V con doppio selettore di wattaggio e colore luce) e DALI-2, offre un'illuminazione personalizzabile ed efficiente. Ideale per officine, magazzini, centri logistici e stabilimenti industriali, ATLAS ottimizza il consumo energetico e migliora la qualità del lavoro. Il modulo sensore permette di programmare accensione, spegnimento e modalità stand-by, rendendolo perfetto per ambienti di passaggio.

ATLAS is the all-in-one industrial suspension. Made of aluminum, it is designed to reach the highest versatility and power. Available in Multilight (dimnable 0-10 V with double wattage and light color selector) and DALI-2 versions, it offers customizable and efficient lighting. Ideal for workshops, warehouses, logistics centers and industrial plants, ATLAS optimizes energy consumption and improves the quality of work. The sensor module allows to program on, off and stand-by mode, making it perfect for passage environments.



INCLUDED



ANELLO FILETTATO PER INSTALLAZIONE A SOSPENSIONE
THREADED RING FOR SUSPENDED INSTALLATION

3-IN-1 INSTALLATION

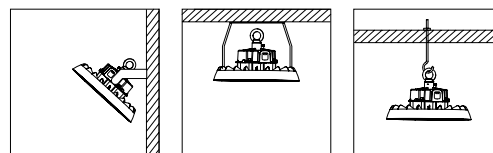

INSTALLABILE A PARETE/SOFFITTO O A SOSPENSIONE TRAMITE ACCESSORI OPZIONALI
SUITABLE FOR WALL/CEILING OR SUSPENSION INSTALLATION USING OPTIONAL ACCESSORIES

DALI-2

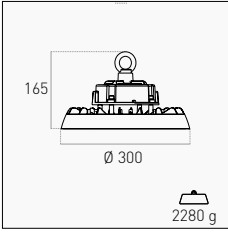

SOURCE		OUTPUT			
200 W	34.700 lm	30.000 lm	4000 K	ATSD-20015040 NEW	1/1 260,00 €
120-277 V	IP65 IK10 110°	3-in-1 INSTALLATION	DIMMABLE DALI-2	DIE CAST ALUMINUM	PC DIFFUSER
					50.000 h 5 YEARS

MULTILIGHT

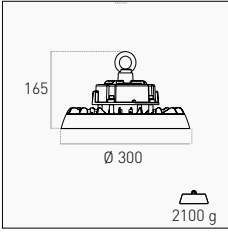

MULTIWATT		SOURCE		OUTPUT		BICOLOR			
100 W - 150 W - 200 W	34.700 lm	30.000 lm	4000 K - 5000 K	ATS-20015000 NEW	1/1 195,00 €				
120-277 V	IP65 IK10 110°	3-in-1 INSTALLATION	DIMMABLE 0-10 V	MULTIWATT	BICOLOR	DIE CAST ALUMINUM			

OPTIONAL (MULTILIGHT)

SENSORE IP65 A MICROONDE E CREPUSCOLARE PROGRAMMABILE
IP65 MICROWAVE AND TWILIGHT PROGRAMMABLE SENSOR

ATS-SENS NEW	1/20	35,00 €
---------------------	------	---------

TELECOMANDO MULTIFUNZIONE A INFRAROSSI
IR MULTIFUNCTION REMOTE

ATS-CNTR NEW	1/10	69,00 €
---------------------	------	---------

Il telecomando è necessario per la programmazione e la personalizzazione di tutte le funzionalità del sensore.
The remote control is required for programming and customization of all sensor functions.

MULTILIGHT				
A	B	C	CW	NW
200 W	150 W	100 W	4000 K	5000 K



DOPPIO SELETTORE PER LA REGOLAZIONE DI POTENZA E TEMPERATURA COLORE LUCE
DOUBLE SELECTOR FOR ADJUSTING POWER AND LIGHT COLOR TEMPERATURE

OPTIONAL

CAVO DI SICUREZZA SAFETY CABLE	STAFFA PARETE/SOFFITTO WALL/CEILING BRACKET	LENTI CON FASCIO LUMINOSO STRETTO NARROW LIGHT BEAM LENSES	GRIGLIA PROTETTIVA SAFETY GRID	RIFLETTORE REFLECTOR
45 cm	Steel	60°	Steel	Aluminum
ATS-CABLE NEW	ATS-BK NEW	ATS-LENS60 NEW	ATS-GRIK NEW	ATS-RFL NEW
1/10	1/10	1/10	1/10	1/10
12,00 €	42,00 €	18,00 €	35,00 €	79,00 €
		90°		PC
		ATS-LENS90 NEW		ATS-RFLP NEW
		1/10		1/10
		18,00 €		42,00 €



SOSPENSIONE INDUSTRIALE
DISCOVERY MAX

SOSPENSIONE INDUSTRIALE DISCOVERY MAX



IP65

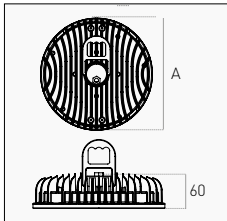

	A mm	g
100 W	Ø 220	1432
150 W	Ø 260	1968
200 W	Ø 300	1616

	OUTPUT 360°	OUTPUT 120°			
100 W	11.830 lm	9.500 lm	4000 K	DSCM-10011040	1/4 99,00 €
150 W	16.870 lm	14.250 lm	4000 K	DSCM-15011040	1/4 139,00 €
200 W	22.570 lm	19.000 lm	4000 K	DSCM-20011040	1/4 159,00 €



Sospensione industriale ad alta dissipazione. Struttura robusta e resistente agli urti. Installazione a sospensione tramite supporto incluso oppure a parete o soffitto tramite staffa opzionale. Ideale per l'illuminazione di aree produttive e logistiche dove è richiesto un elevato livello di flusso luminoso e prestazioni.

High dissipation industrial suspension. Rugged and impact resistant construction. Suspended installation with support included. Wall or ceiling installation using the optional bracket. Suitable for industrial and logistic area where high level of luminous flux and performance is required.

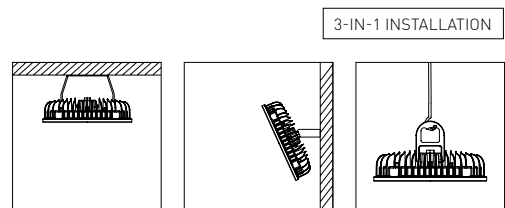

INSTALLA DISCOVERY MAX A SOSPENSIONE TRAMITE SUPPORTO INCLUSO O A PARETE/SOFFITTO TRAMITE STAFFA OPZIONALE
INSTALL DISCOVERY MAX SUSPENSION USING THE INCLUDED SUPPORT OR WALL/CEILING USING THE OPTIONAL BRACKET

INCLUDED

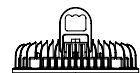

SUPPORTO PER GANCIO PER INSTALLAZIONE A SOSPENSIONE
HOOK SUPPORT FOR SUSPENDED INSTALLATION

OPTIONAL

STAFFA PER MONTAGGIO A PARETE O SOFFITTO
WALL OR CEILING MOUNTING BRACKET



DSCM-BK

27,25 €

SORGENTI

GO SMART

VERSATILI

INDOOR

OUTDOOR

SOLARI

WORK

PROFESSIONAL

ESPOSITORI

DISPLAY
DISPLAY
DISPLAY



09



ESPOSITORI

ESPOSITORI

ESPOSITORI



ESPOSITORI IN LEGNO
DOUBLE EXPO
MULTI SHOW



DISPLAY DA TERRA
EXPO CEN
NEW EXPO COMBO
EXPO VASCH



ESPOSITORI LAMPADE
BALUX 5
BALUX 12



STRIP E PROFILI
NEW EXPO STRIP
EXPO PR



BANNER ESPOSITIVI



CESTO PROMO
EXPO PROMO
CROWNER EXPO PROMO



DISPLAY
MAGIC BOX
GO SMART

SORGENTI

GO SMART

VERSATILI

INDOOR

OUTDOOR

SOLARI

WORK

TECHNICAL

ESPOSITORI



ESPOSITORE IN LEGNO

DOUBLE EXPO

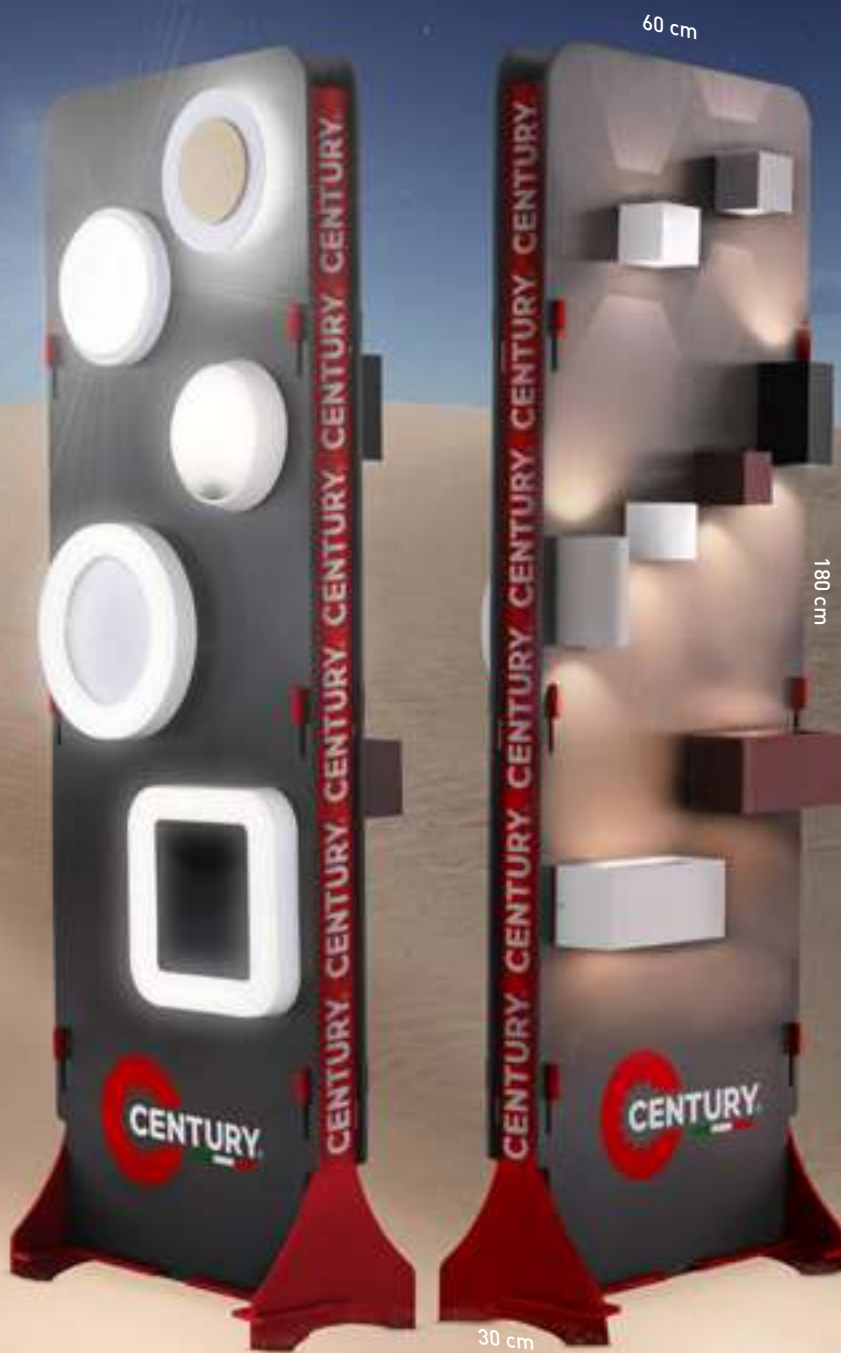

EXPO-DBL	1/1
----------	-----

Espositore in legno bifacciale con prodotti campione già elettrificati pronti per essere collegati alla rete e mostrati in funzione.
Double face wooden display with electrified sample products, ready to be connected to the network and shown in operation.

ESPOSITORE IN LEGNO MULTI SHOW



FIESTA
KIT-EX-2RIP-FST 1/1

ARCADIA
KIT-EX-2RIP-ARC 1/1

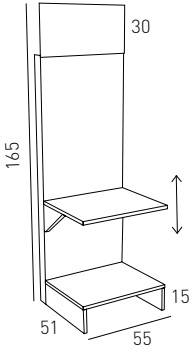

PL-QUADRO / PL-TONDO
KIT-EX-2RIP-PQT 1/1

GIARDINETTO
KIT-EX-2RIP-GRD 1/1

Espositori in legno forniti di prodotti campione già elettrificati pronti per essere collegati alla rete e mostrati in funzione.
Wooden display supplied with electrified sample products ready to be connected to the network and shown in operation.

NEW

ESPOSITORI

SISTEMI ESPOSITIVI



DISPLAY DA TERRA FLOOR DISPLAY

Espositore in cartone con 20 ganci metallici, fornito vuoto
Cardboard display with 20 metal hooks, products not included



457 x 1800 x 400 mm



DISPLAY DA TERRA FLOOR DISPLAY

Espositore in cartone modulare 2-in-1
2-in-1 Modular cardboard display



530 x 1800 x 400 mm



DISPLAY DA TERRA FLOOR DISPLAY

Espositore in cartone modulare con 3 vasche innestabili
Modular cardboard display with 3 plug-in bowls



600 x 1780 x 400 mm



ESPOSITORE PROVA LAMPADE TEST LAMPS EXHIBITOR



440 x 140 x 220 mm



ESPOSITORE PROVA LAMPADE TEST LAMPS EXHIBITOR

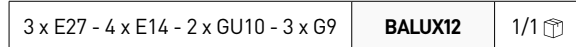

990 x 140 x 240 mm

Espositore professionale elettrificato con plexiglass di protezione. Interruttore a pressione, quando rilasciato la lampada si spegne.
Professional electrified display with protective plexiglass. Push switch, when released the lamp turns off.



ESPOSITORE STRISCE STRIPS EXHIBITOR

Espositore elettrificato con 9 campioni
Electrified display with 9 samples



320 x 175 x 80 mm



ESPOSITORE PROFILI PROFILES EXHIBITOR

Espositore con 19 profili campione
Display with 19 sample profiles



320 x 175 x 80 mm

ESPOSITORI

SISTEMI ESPOSITIVI

BANNER ESPOSITIVI EXHIBITION BANNERS

400 x 300 mm	Profili	BAN40-PROFILI	1/1 
995 x 500 mm	Classic	BAN100-CLAS	
	Filamento Clear	BAN100-FILCL	
	Filamento Mix	BAN100-FILMX	
	Filamento Saten	BAN100-FILST	
	Strip LED	BAN100-STRIP	
995 x 650 mm	Proiettori	BAN100-FARI	
	Special	BAN100-SPEC	
1320 x 500 mm	Classic	BAN133-CLAS	
	Filamento Clear	BAN133-FILCL	
	Filamento Mix	BAN133-FILMX	
	Filamento Saten	BAN133-FILST	
	Special	BAN133-SPEC	
	Proiettori	BAN133-FARI	

Banner espositivi in Forex, misure assortite
Forex display banners, assorted sizes



CESTO PROMO PROMO BASKET
Espositore da terra in cartone fornito vuoto
Cardboard floor display supplied empty

EXPO-PROMO	1/1 
-------------------	---

550 x 400 x 850 mm



CROWNER EXPO PROMO

Pannello in cartone da associare a EXPO-PROMO
Cardboard panel to be associated with EXPO-PROMO

Go Smart	CRW-G3SMART	1/1 
Sensor	CRW-G3SP	
Killer 50	CRW-KLR	

540 x 700 mm



DISPLAY DA BANCO COUNTER DISPLAY
Display in cartone capiente e facile da montare
Large and easy to assemble cardboard display

MAGIC BOX	1/25 
------------------	--

330 x 650 x 10 mm



DISPLAY GO SMART
Display in cartone microonda
Display in microwave cardboard

EXPO-GOSMART	1/1 
---------------------	---

700 x 470 x 300 mm

PIASTRINA ESPOSITIVA EXHIBITION PLATE
Piastrina espositiva per lampade E14 o E27
Exhibition plate for E14 or E27 lamps

E14	PIASTRINA P E14	1/1 
E27	PIASTRINA P E27	
	PIASTRINA G E27	

10 x 8 mm



FINE CORSA END-OF-STROKE
Talloncino fustellato di fine corsa per ganci
End-of-stroke punched-out for hooks

XT-FC	1/200 
--------------	---

70 x 119 mm

CONDIZIONI GENERALI DI VENDITA

GENERALITÀ

Le condizioni generali di vendita, qui di seguito riportate, si intendono valide per qualsiasi ordine pervenuto alla ns. Azienda e costituiscono parte essenziale di ciascun ordine. Eventuali modifiche alle presenti clausole nonché eventuali condizioni particolari dovranno essere espressamente concordate per iscritto.

ORDINI

Le ordinazioni acquisite dalla nostra organizzazione di vendita sono soggette all'approvazione della ns. Azienda. Non si accettano ordini d'importo inferiore a € 500,00 + IVA. Ordini pervenuti con quantità inferiori agli standard indicati a listino, saranno automaticamente arrotondati all'imbello minimo, altrimenti non potranno essere gestiti.

TRASPORTO

La merce viaggia a rischio e pericolo del Committente il quale, nel proprio interesse, deve verificare, prima del ritiro, l'integrità dei colli e la quantità della merce ricevuta. Eventuali reclami dovranno essere avanzati direttamente al vettore al momento della consegna e comunicati anche alla ns. Azienda, come indicato al capitolo "Reclami".

CONSEGNE

I termini di consegna hanno carattere puramente indicativo e non hanno valore contrattuale. La spedizione viene effettuata unicamente con ns. corrieri convenzionati. La consegna si intende effettuata nel momento in cui la merce viene conferita al vettore. La consegna della merce con procedure d'urgenza e/o sponda idraulica, verrà effettuata solamente previa accettazione da parte dell'acquirente del costo aggiuntivo relativo al servizio richiesto. All'atto della consegna l'acquirente si impegna a verificare immediatamente e in presenza del vettore la conformità quantitativa e l'integrità dei colli inviati rispetto al D.D.T. e al packing-list, anche per consegne con pallets filmati.

GARANZIA

La ns. Azienda garantisce che i prodotti sono esenti da vizi o difetti di fabbricazione per un periodo di 2 anni decorrente dalla data di consegna dei medesimi al Cliente. La garanzia non opererà con riferimento a quei prodotti i cui difetti sono dovuti a:

- I** Danni causati durante il trasporto; (ad eccezione di quanto indicato al capitolo "Reclami").
- II** Lampade che presentino rotture di vetri (ad eccezione di quanto indicato al capitolo "Reclami").
- III** Un uso negligente o improprio degli stessi;
- IV** Inosservanza delle istruzioni della ns. Azienda riguardanti il funzionamento, manutenzione e conservazione dei prodotti;
- V** Riparazioni o modifiche apportate dal Cliente o da soggetti terzi senza la previa autorizzazione scritta della ns. Azienda.
- VI** In ogni caso il Cliente non potrà far valere i diritti di garanzia verso la ns. Azienda, se il prezzo dei Prodotti non sia stato corrisposto alle condizioni e nei termini pattuiti, anche nel caso in cui la mancata corresponsione del prezzo alle condizioni e nei termini pattuiti si riferisca a prodotti diversi da quelli per i quali il Cliente intende far valere la garanzia. La ns. Azienda non riconosce alcuna garanzia circa la conformità dei prodotti alle norme e ai regolamenti di Paesi che non rientrano o non appartengono all'Unione Europea.

RECLAMI

A condizione che il reclamo del Cliente sia coperto dalla garanzia e notificato nei termini sotto indicati, la ns. Azienda si impegnerà, a sua discrezione, a sostituire o riparare ciascun prodotto o le parti di questo che presentino vizi o difetti. Eventuali reclami devono essere inviati per iscritto alla ns. Azienda entro 8 giorni dal ricevimento della merce. Per reclami relativi a differenze quantitative o per colli danneggiati, o per rotture di vetri delle lampade, dovranno essere evidenziati sia nel D.D.T. che nella lettera di vettura del corriere, pena la non ns. accettazione del reclamo. Non sarà accettato nessun reclamo se non esclusivamente operato nel modo sopraindicato.

RESI MERCE

Eventuali prodotti difettosi potranno essere resi esclusivamente previa ns. autorizzazione, con le modalità che Vi saranno comunicate dall'ufficio contestazioni al momento della richiesta di reso. Previa iniziale valutazione telefonica, o eventuale ns. intervento diretto per la prima verifica, seguiranno istruzioni da parte della ns. Azienda per effettuare il reso. I resi autorizzati dovranno essere inviati ai magazzini, corredati di regolare D.D.T. e dei relativi estremi d'acquisto. Prodotti che hanno subito un utilizzo, anche parziale, non possono essere considerati difettosi; in questo caso si valuterà la convenienza della sostituzione del componente danneggiato, con spese a carico dell'acquirente. Si precisa che con il termine "materiale difettoso" è inteso qualsiasi prodotto che non abbia subito alcun utilizzo e che presenti evidenti anomalie di fabbricazione e/o di funzionamento. Non rientrano nel campo dei difettosi le lampade che presentano rotture di vetri. Altri prodotti potranno essere resi esclusivamente previa ns. autorizzazione, in porto franco, con le modalità che Vi saranno comunicate dall'ufficio contestazioni al momento della richiesta di reso ed accreditati al prezzo di acquisto dedotto un minimo del 10% per le spese di controllo, rimborso e riposizionamento a magazzino. Non potranno essere prese in considerazione richieste di resi di materiale la cui consegna risalga a più di 24 mesi prima della richiesta di restituzione, ed inoltre per articoli non presenti nell'attuale listino.

PAGAMENTI

I pagamenti devono essere eseguiti alla ns. Azienda, alla scadenza stabilita e per l'importo pattuito, ed indirizzati unicamente alla ns. sede amministrativa. In caso di ritardo del pagamento delle scadenze, anche parziale, oltre i termini concordati, l'Azienda si riserva la facoltà a sospendere successivi invii di merce. Saranno conteggiati gli interessi bancari per il ritardo sul pagamento concordato, secondo le modalità di legge in vigore.

PROPRIETÀ DELLA MERCE

La ns. Azienda rimane proprietaria della merce fino al completo pagamento della stessa da parte del Committente.

MISURE E DISEGNI

Le indicazioni di misure e disegni riguardanti la costruzione dei prodotti, le dimensioni, le caratteristiche tecniche e/o fotometriche, presenti su qualsiasi pubblicazione della ns. Azienda, sono da intendersi a puro titolo informativo e possono essere soggette a modifiche senza alcun preavviso. Per informazioni aggiornate sui prodotti, visitare il sito: www.century-italia.com.

RESPONSABILITÀ

I prodotti devono essere utilizzati e/o installati nel rispetto delle loro caratteristiche tecniche e delle istruzioni indicate, in osservanza delle disposizioni di sicurezza esistenti nel paese di utilizzo e/o d'installazione. La ns. Azienda declina ogni responsabilità per eventuali danni che possono, direttamente o indirettamente, derivare a persone, cose ed animali domestici, in conseguenza della mancata osservanza di tutte le prescrizioni indicate sui prodotti e/o sulle istruzioni per l'uso e/o per installazione. La ns. Azienda declina inoltre ogni responsabilità, qualora i prodotti fossero utilizzati per applicazioni speciali, o installati in posizioni per le quali si richiedesse l'ausilio di ponteggi, trabatelli o gru; non sono pertanto imputabili alla ns. Azienda costi di disinstallazione o sostituzione, in caso di eventuali difettosità dei prodotti.

PROPRIETÀ INTELLETTUALE

La ns. Azienda si riserva i diritti, il titolo e la proprietà intellettuale su documenti, disegni, fotografie e schede fornite al Cliente. Il Cliente non potrà utilizzare tale documentazione, senza previa autorizzazione scritta della ns. Azienda, per la realizzazione di propri cataloghi, volantini promozionali, siti web o qualunque altro mezzo divulgativo e/o pubblicitario.

FORO COMPETENTE

Per ogni controversia che dovesse sorgere tra la ns. Azienda ed il Committente, si intende eletto Foro competente quello della Ditta Venditrice.

GENERAL TERMS OF SALE

GENERAL INFORMATION

The general terms of sale below are valid for any order received from our Company and they are an essential part of each order. Any change to these clauses and any particular condition must be expressly agreed in writing.

ORDERS

Orders acquired by our sale team are subject to our Company approval. Orders received with quantities less than the listed standards will be automatically rounded to the minimum packaging, otherwise they will not be managed.

TRANSPORTATION

The goods travel is at Client risk. It's in his own interest to check, before withdrawal, the integrity of packages and quantity of received goods. Any complaint must be made directly to the carrier at delivery time and communicated to our Company, as stated in the chapter "Complaints".

DELIVERY

The terms of delivery are purely indicative and have no contractual value. The shipment is carried out only with our trusted couriers. The delivery is intended to be made at the time the goods are delivered to the carrier. The delivery of the goods with emergency procedures and/or hydraulic bank, will be carried out only after acceptance by the Client of the additional cost related to the requested service. At delivery time, the Client undertakes to check immediately the quantitative compliance and integrity of the received packages as mentioned on Transport Document and the packing-list, even for deliveries with filmed pallets.

WARRANTY

Our Company guarantees that the products are free of manufacturing defects for a period of 2 years from the date of delivery to the Client. The warranty will not cover products whose defects are due to:

- I** Damage caused during transport; [except what is described in the "Complaints" chapter].
- II** Lamps with broken glass [except what is described in the "Complaints" chapter].
- III** A negligent or improper use;
- IV** Non-compliance with the instructions of our Company regarding the use, maintenance and preservation of products;
- V** Repairs or changes made by the Client or third parties without the prior written permission of our Company.
- VI** In any case, the Client will not be able to claim the warranty rights to our Company if the price of the products has not been paid under the agreed terms and conditions, even if the non-payment refers to products different from those for which the Client intends to make guarantee. Our Company does not recognize any guarantee regarding products compliance with the rules and regulations of countries not belonging to the European Union.

COMPLAINTS

As long as the Client complaint is covered by the warranty and notified in the below terms, our Company will undertake at its discretion to replace or repair each defective product or component. Any written complaint must be received by our Company within 8 days from delivery. Complaints about quantitative differences or damaged packages, or for broken lamps, should be highlighted on the Transport Document and the courier's letter. Any other way will be not accepted.

RETURNS

All defective products can be returned after our permission only. Naturally it is necessary a first evaluation or check, then instructions from our Company to make the return will follow. Authorized returns must be sent to our warehouses with Transport Document and related purchase details. Products that have been used, even partially, cannot be considered defective; in this case, the convenience of replacing the damaged component will be evaluated, at Client cost. It should be noted that the term "defective" means any product that has not been used and has obvious manufacturing and/or operating anomalies. Broken glass lamps do not fall within the field of defectiveness. Other products can be returned by our permission only, freight prepaid, as communicated by the claim's office at the time of the request. The price paid for the product will be refunded except 10 % charged for control, repackaging and repositioning in stock. Requests for returns of goods delivered more than 24 months before the claim will not be considered.

PAYMENTS

Payments must be made to our Company at the fixed deadline for the agreed amount and addressed only to our administrative headquarters. In the event of a delay in the payment, even partial, beyond the agreed deadlines, the Company reserves the right to suspend subsequent deliveries of goods. Bank fee will be counted for the delay on the agreed payment according to the current legal arrangements.

PROPERTY OF GOODS

Our Company remains the owner of the goods until the Customer pays for them in full.

SIZES AND DESIGNS

Technical drawings related to the construction of products, dimensions, technical and/or photometric characteristics on any publication of our Company, have to be understood as informational and may be subject to change without any notice. For the latest product information, visit: www.century-italia.com.

RESPONSIBILITY

The products must be used and/or installed in accordance with their technical characteristics and instructions, in accordance with the safety regulation in the country of use and/or installation. Our Company disclaims any liability for any damage that may, directly or indirectly, result from people, things and pets, as a result of non-compliance with all the requirements stated on the products and/or instructions for use and/or for installation. Our Company also disclaims any responsibility if the products are used for special applications, or installed in locations for which scaffolding, beams or cranes are required; costs of uninstallation or replacement, in case of any product defect, are therefore not charged by our Company.

INTELLECTUAL PROPERTY

Our Company reserves the rights, title and intellectual property on documents, drawings, photographs and datasheets provided to the Client. The Client can't use this documentation – without prior written permission from our Company – for the creation of its own catalogues, promotional flyers, websites or any other means of dissemination and/or advertising.

PLACE OF JURISDICTION

For every dispute that arises between our Company and the Client, the place of jurisdiction is intended to be the Seller's one.

