



AULIX lighting

návrhy osvětlení a prodej svítidel
inteligentní systémy, vypínače

SVĚTELNÉ STUDIO

Náměstí Na Sádkách 705
252 41 Dolní Břežany (Praha západ)

Telefon: +420 246 083 152

Mobil.: +420 702 061 783

E-mail: studio@aulix.cz

Web: www.aulix.cz

E-shop: <http://obchod.aulix.cz>

Sledujte nás také na sociálních sítích:



All prices are recommended gross sales prices including VAT. We keep the right to adjust the prices during the validity of the catalogue. You will always find the current prices on our website. Our general terms and conditions apply. Errors and availability reserved. All articles are basically delivered without illuminants, unless the product description specifies otherwise.



LIGHTING DESIGN AND 3D VISUALISATION

Light is more than just its technical values. Light evokes emotions, sets the scene for people, rooms and objects and has a decisive influence on our well-being and daily rhythm. Accordingly, it is not only the luminaire itself that plays a decisive role for private and commercial end customers, but also its lighting effect. »What will the light look like afterwards?« – In order to answer this frequently asked question in advance we are now offering our customers an extended service and taking over the lighting design and 3D lighting calculation for your project!



Dialux member

As an official Dialux member, Deko-Light luminaires are integrated into the world's leading lighting design software and can be used for lighting design, calculation and 3D visualisation in DIALux evo. Once the lighting design has been completed, the software creates informative project documentation in PDF form with all the details of the property, lighting concept, the luminaires used and the results of the lighting design, including the normative certificates.



Are you interested in our lighting design service?

Your contact person will explain the next steps and will be happy to answer any questions you may have.

04 product presentation

INTERIOR LIGHTS

- 34 pendant lights
- 56 surface mounted ceiling lights
- 98 built in ceiling lights
- 148 insert panels
- 170 surface mounted wall lights
- 184 built in wall lights
- 190 reading lights
- 196 table and floor lights
- 204 showcase lights
- 212 office lights
- 236 hall floodlight
- 242 damp-proof luminaires

POWER RAILS

- 258 D ONE 1-phase power rail system
- 276 1-phase power rail luminaires
- 290 D LINE 3-phase power rail system
- 322 D LINE DALI 3-phase power rail system
- 348 3-phase power rail luminaires

BATTERY AND SOLAR LIGHTS

- 386 battery lights
- 396 solar lights

OUTDOOR LIGHTS

- 402 bollard lights
- 424 surface mounted wall lights
- 454 ceiling and wall lights
- 458 built in wall lights
- 464 spherical lamps
- 468 energy distributor
- 478 surface mounted and ground spike lights
- 490 wall washer
- 494 ground recessed lights
- 516 floodlight
- 522 display lights

SYSTEM PLANO

- 528 PLANO luminaire system
- 546 PLANO-profiles

SYSTEM COMBO

- 560 concrete profiles
- 564 Installation profiles
- 568 Insulation profiles
- 570 Click profiles

ALUMINIUM PROFILES

- 574 linear light in 5 steps
- 576 aluminium profiles | overview
- 587 assembly for profiles and stripes
- 580 homogeneous light image
- 582 U-profiles | flat + high | built-in/built-on
- 605 T-profiles | flat + high | built-in
- 624 H- und groove-profiles
- 632 step/plinth/angle/corner-profiles | built-in/built-on
- 658 dry construction profiles
- 678 tile profiles
- 694 profiles for outdoor use | walkable/trafficable

LED STRIPES

- 708 LED stripes | overview
- 710 technical information
- 712 COB
- 722 12V
- 726 24V
- 758 48V
- 764 230V

POWER SUPPLIES

- 768 power supplies | overview
- 770 technical information
- 772 DC | CV | quick finder
- 776 DC | CV
- 790 DC | CC | quick finder
- 793 DC | CC
- 804 AC | CV | quick finder
- 805 AC | CV

CONTROLLER

- 810 controller | overview
- 812 RF-smart
- 834 RF control
- 840 Casambi Bluetooth
- 844 DMX wall controller
- 850 DMX controller
- 852 DMX dimmer
- 858 DALI PWM dimmer

ILLUMINANTS

- 866 G4 | G53 QR111
- 868 MR16/GU5,3
- 869 G9 | GU10
- 873 E14
- 874 E27
- 884 R7s | GX53

ACCESSORIES

- 890 indoor | dimming and switching
- 891 indoor | other
- 892 indoor | low voltage
- 896 outdoor | low voltage DC | WEIPU HQ plug-in connector
- 901 indoor | DMX cable
- 903 indoor | high voltage
- 906 indoor | high voltage | plug systems
- 908 outdoor | high voltage | plug systems
- 911 outdoor | cable connectors
- 916 mounting material for LED stripes and profiles
- 918 outdoor | mounting accessories
- 919 chemical products

- 922 legend
- 924 Energy efficiency class
- 926 technical information
- 932 lighting solutions
- 944 index

LUCEA

The LUCEA series includes pendant, ceiling and track luminaires and impresses with its timeless design and flexible customisation options.

All information on the LUCEA series can be found from page 46 onwards.

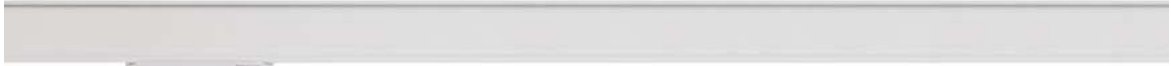

lenses

Depending on the model, you can narrow or widen the beam angle of the LUCEA luminaires using the easily replaceable lenses.

reflector rings

With the reflector rings [available for all models in black, white and gold], you can set colourful accents depending on the surroundings and atmosphere.

door panels

With the optional barn door trim, you can limit the light emission of the LUCEA luminaires with particular precision using four individually adjustable wings.

LUCEA-VARIETY

surface-mounted lights

The LUCEA surface-mounted luminaires are available as pendant luminaires, as swivelling and tilting ceiling luminaires with a base and as fixed spotlights.



1-phase luminaires

The pendant luminaires with a particularly soft textile cable and the spotlights for use on single-circuit track systems are primarily aimed at private users looking for a slim and versatile solution for the home.



3-phase luminaires

The LUCEA luminaires for 3-phase 230V track systems are available as ceiling and pendant versions and, thanks to the CCT dip switch, are particularly suitable for commercial use in bars, restaurants or offices.



FLEXIBLE COLOUR TEMPERATURE

The colour temperature has a decisive influence on the lighting effect in the room. For this reason, the LUCEA series is available in different colour temperatures, depending on the model and intended use. With an Ra value >90, the LUCEA luminaires also guarantee true-to-life colour rendering of walls, ceilings and objects. Using the LUCEA ceiling light as an example, you can see in the illustrations below how the light colour and lighting mood change depending on the model version - from warm white to neutral white and as a flexible dim-to-warm version.

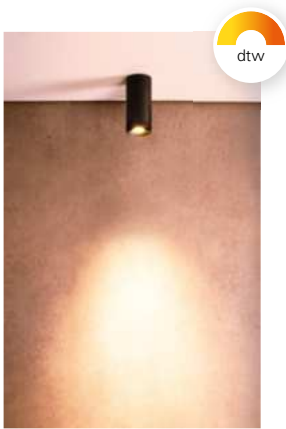

dim-to-warm

[1,800K - 2.700K]

In the dim-to-warm version, the colour temperature adjusts automatically when dimming [the lower the light intensity, the warmer the colour temperature].



2,700 K

For private users: the lights with extra warm white 2,700K.

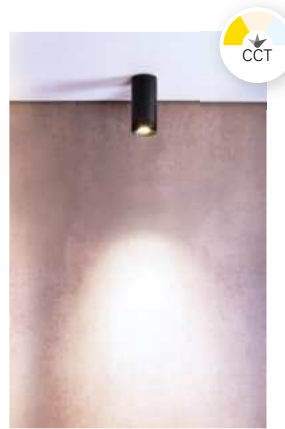

3,000 K

For commercial applications: The surface-mounted and 3-phase luminaires offer a CCT dip switch to switch between 3,000K [warm white] and 4,000K [neutral white].



4,000 K

In addition to the CCT versions, the 3-phase spotlights with 40W are also available as a pure 4,000K [neutral white] version.



Technical data sheet

New in the onlineshop: The technical data sheets offer even more information: Light and energy data, light distribution curves, dimensional drawings and more.

FLEXIBLE BEAM ANGLE

Wide, soft light or a precise, focussed spot – with the LUCEA series you have the choice, even retrospectively. In addition to the standard beam angle of 36°, the luminaires can be narrowed or widened in all versions [surface-mounted, pendant, track] using optionally available lenses. You are even more flexible with the optional, colour-matching barn door cover. With its four wings, the light emission can be adapted to different room and object geometries. The illustrations below show how the light emission of the LUCEA changes through the use of different lenses and the barn door.



24°
narrow beam angle with optional 24° lens



36°
standard beam angle with 36° lens [standard]



60°
wide beam angle with optional 60° lens

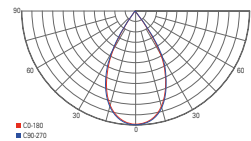
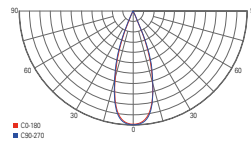
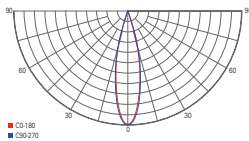

door panels

individual limitation of the beam angle with the wings of the barn door panel

CAN

The new CAN series is an all-round solution for both private and commercial use. Available as a pendant light, ceiling light, wall light, reading light and outdoor light, the CAN feels at home in living rooms, hotel rooms, restaurants and many other environments. All versions have the GU10 socket in common, which enables a flexible choice and easy replacement of the light source.

All information on the CAN series can be found from page 50 onwards.

Coming Soon: Variety of colours

In future, users will be able to customise the look of the CAN luminaires. The optional coloured covers and housing rings [coming soon] can be screwed on and off without the use of tools using a thread – even on luminaires that are already installed.



THE VARIANTS



CAN pendant light

The CAN pendant luminaire is available in two lengths: 150 and 350 mm



CAN surface-mounted ceiling light

The CAN surface-mounted ceiling light is available as a single and three-lamp version and as an IP40 version for use in damp rooms.



CAN wall light

The CAN wall light is available as a classic spotlight and as an up/down version with light emission on both sides.



CAN reading light

The CAN reading light is available in round and square versions and offers a charging option for smartphones & co. via USB-C / USB-A - perfect for use in hotel rooms next to the bed.



CAN outdoor light

The CAN outdoor light is IP65-certified and available as a classic wall light and as an up/down version with light emission on both sides.



Simple assembly

The CAN lights are equipped with plug-in terminals for rigid and flexible cables for easy installation.

GU10

The widely used GU10 base enables quick and easy replacement of light sources.

Screwable cylinder

No tools required: To gain access to the light source, the cylinder housing of the CAN can simply be screwed on and off.

Interchangeable decorative ring

Set individual accents - with optional, coloured decorative rings that can be replaced quickly and easily.

UNI II

The UNI II series comprises high-quality surface-mounted luminaires and track-mounted spotlights for use on walls and ceilings in commercial and private premises.

The rotating and swivelling luminaire heads of the UNI II series – available in white and black aluminium housing versions – are equipped with warm white COB LEDs and can be folded flush onto the base if required to shine vertically downwards like a ceiling spotlight. In addition to the single, double and triple versions, both a MINI version [with smaller luminaire head and base] and a MAX version are available.

All information on the UNI II series can be found from page 70 onwards.

THE SERIES AT A GLANCE



UNI II

The standard version [TILT] with 3,000 K is also available with two [DOUBLE] and three [TRIPLE] luminaire heads on a base and as a wall-mounted version.

UNI II MINI

The MINI version [optionally 2,700 K or 3,000 K] is available with one [MINI II TILT] or two [MINI II DOUBLE] luminaire heads and is suitable for particularly discreet use in small rooms.

UNI II MAX

THE MAX version [3,000 K] with its 2,410 lumens also makes a big impression on its own.



UNI II TRACK SPOT

Whether private [1-phase] or commercial [3-phase]: As a track spotlight, the UNI II can be aligned even more flexibly in the room. Available as a standard version [UNI II TILT] and as a MINI version [MINI II TILT].

UNI II WALL LIGHT

The surface-mounted wall light is available in white and black and can be swivelled up/down by up to 90° to position the warm white light [3,000 K] precisely in the room.

UNI II RECESSED LIGHT

The rotatable and swivelling luminaire head of the UNI II recessed luminaire [also available as a MINI and MAX version] can be folded flush onto the base if required in order to shine vertically downwards like a ceiling spotlight.

VERSATILE ACCESSORIES

THE UNI II series offers numerous options to further individualise the light and appearance of the luminaires:



Reflectors

Interchangeable reflectors for narrower [24°] or wider [48°] light emission.

Lenses

Interchangeable lenses in clear/satin finish for a broader and/or softer light.

Honeycomb filter

Optional honeycomb filter to reduce glare.

Reflector rings

Interchangeable reflector rings [black, glossy black, gold, chrome] for customising the lighting effect.

Covers

Covers [white, black] as replacement or deliberate colour contrast when UNI II is opened.





MADERA

The MADERA luminaire family is made from FSC-certified European oak wood and comes from sustainable forestry. Available as a pendant, ceiling, wall or table/floor lamp, MADERA blends seamlessly into private living areas, hotels, restaurants and more with its modern and natural appearance. To ensure flexibility even after installation, the pendant luminaires can be infinitely adjusted in height using a cable pull.



page 55



page 95



page 182



page 202



page 203



BRAHE

Whether as a wall light next to the bed, as a bedside lamp or as a floor lamp behind the reading chair – when you put the book or newspaper to one side, many reading lights often lack indirect lighting options. This is where BRAHE comes in with its illuminated base, which can be switched separately and creates atmospheric, indirect islands of light.



page 193



page 192



page 198



page 199



LED DESIGN BULB ORBIT E27 DIMMABLE

Let our new design lamp series ORBIT, SHINE and MOON take you into the world of style. The filigree light body and the reflections created in the glass give the impression of floating light. Whether light and airy in the living room at home or opulent and spacious in the hotel lobby – the dimmable LED lamps in the Design Bulb series are perfect for open luminaires without a shade or socket luminaires with an E27 fitting and are a real eye-catcher wherever they are used.



page 874



page 874



page 876

LED-PANELS

Our STANDARD, BASIC and PRO LED panel series cover all requirements – from flexible all-rounders for private and commercial use to glare-free special solutions for workplace lighting. Whether residential, commercial or office – we have the right solution for your project!

All information on the LED-PANELS can be found from page 152 onwards.

Below you will find an overview of the series, variants and technologies of our LED panels:

SERIES

BASIC

maximum cost efficiency
[power supply unit included]

PRO

maximum performance
efficiency



VARIANTS

FLEX

- BEG-eligible [4000 K]
- CCT switch

OFFICE

- BEG-eligible
- UGR<19
- screen workstation
suitable
[EN 12464-1 BAP65]



TECHNOLOGIES

backlight technology

- high efficiency
- long service life
- low costs



STANDARD

maximum application versatility

FLEX	OFFICE	OFFICE FLEX	SANO	HCL	RGBW/RGBCCT
<ul style="list-style-type: none"> • CCT switch • Ra>90 	<ul style="list-style-type: none"> • Ra>90 • UGR<19 • screen workstation suitable [EN 12464-1 BAP65] 	<ul style="list-style-type: none"> • CCT dip switch • Ra>90 • UGR<19 • screen workstation suitable [EN 12464-1 BAP65] 	<ul style="list-style-type: none"> • T5/T8 refurbishment solution • Ra>90 • BEG-eligible 	<ul style="list-style-type: none"> • HCL controllable [Human Centric Lighting] 	<ul style="list-style-type: none"> • adjustable RGBW- bzw. RGBCCT-colours • Ra>90

sidelight technology

- low housing depth
- wide beam angle [120°]
- simple suspension





OFFICE THREE

The OFFICE THREE series is our bestseller and problem solver for lighting individual workstations. Optionally available as a free-standing or table lamp, the OFFICE THREE impresses with excellent light quality [Ra95] and glare-free [UGR<6] and ensures fatigue-free working in any situation. Thanks to the individually adjustable brightness for direct and indirect light, OFFICE THREE enables high-quality and flexible illumination of individual workstations. Optimised for tables with standard dimensions of 160 x 80 cm, the series is also suitable for other table sizes.

All information on the OFFICE THREE series can be found from page 230 onwards.





The OFFICE THREE is available as STANDARD [with fixed light colour: 4,000 K] and PRO-VARIANTE [with adjustable light colour: 2,700-6,500 K]. Both versions are visually identical and have the same sensor technology. The OFFICE THREE is also available as a table lamp for use on height-adjustable desks. In combination with the separately available mounting adapter, the desk lamp can be attached to any desk position using a small drill hole.



Touch panel

- Brightness of direct and indirect light separately or synchronised, continuously adjustable
- Direct and indirect light can be switched separately
- Light colour infinitely adjustable [PRO models only]
- Follow-up time of the presence sensor adjustable



High-precision radar presence detector

- The 24Ghz presence sensor recognises even the smallest movements on the desk - such as movements of the computer mouse - and switches the light on automatically. Faulty switch-offs are effectively prevented despite the short run-on time.
- If there is no movement, the brightness is reduced to 30% after 5*/15/30 minutes [*default setting].
- If there is no movement, the light switches off after a further 5*/15/30 minutes [*default setting].

Daylight sensor

- Switch on the light and dim to the desired brightness [this setting is saved by the daylight sensor as the default]
- As soon as the ambient light changes, the sensor adjusts the brightness according to the saved standard [10% tolerance].



LINEAR PRO

The LINEAR PRO 3-circuit track luminaires are the ideal solution for illuminating shelves and aisles in supermarkets, shops and more. Available in the LINEAR PRO FOLD and LINEAR PRO TILT versions, the LINEAR PRO models enable precise illumination of products and other objects – also in combination with other track spotlights.

LINEAR PRO: TILT or FOLD?

Both versions – the LINEAR PRO TILT and the LINEAR PRO FOLD - can be flexibly aligned to the respective shop areas in order to illuminate sales shelves evenly and at full height in almost all application scenarios. While the LINEAR PRO TILT can shine downwards as a whole or be tilted individually by up to 30° to each side, the LINEAR PRO FOLD has a three-part construction with two LED wings, which are supplemented by a diffuse light strip in the centre. This makes the LINEAR PRO FOLD particularly suitable for the homogeneous illumination of complete aisles with shelves on both sides, while the LINEAR PRO TILT can be aligned particularly flexibly to individual shelves [or changing shelf arrangements].





3 ADVANTAGES

Adjustable output

The output of the LINEAR PRO 3-phase track luminaires can be adjusted in three stages to optimally adapt the light to the respective requirements and shop designs. The LINEAR PRO luminaires are also DC-capable and can be integrated into corresponding emergency power systems.

BEG subsidy

The LINEAR PRO luminaires fulfil the requirements of the BEG subsidy for particularly efficient LED luminaires and are subsidised by the Federal Ministry of Economics and Climate Protection with 15%.

Seamlessly combinable

The 1500 mm versions of the LINEAR PRO have a sliding track adapter and are each available in 50% mirrored A/B versions to enable seamless side-by-side installation, even across track connectors.

All information on the LINEAR PRO series can be found from page 356 onwards.



D LINE DALI

The D LINE 3-phase track system is the ideal lighting solution for all commercial applications and impresses with its particularly versatile planning and installation. D LINE is now also available as a DALI version and offers users even more flexible control of all components in the track system. With D LINE DALI, planning track [structure and installation] is easier than ever before.

With its elegant and timeless design [available in white and black], D LINE DALI blends seamlessly into a wide variety of environments - from use in the hospitality and retail sectors to covering entire shopping centres or corporate buildings. Thanks to the wide range of accessories and mounting components, there are no limits to its use and installation. The new interchangeable mechanism of the 90° and T-connectors makes planning easier than ever before, so that even the installation of complex shapes is child's play.

D LINE DALI is compatible with all standard luminaires – standard spotlights and DALI spotlights can be operated simultaneously. be operated simultaneously.

All information on the D LINE DALI series can be found from page 322 onwards.

THE COMPONENTS



Electrical feeder

Feed-in of up to three phases [3x 16A]



Electrical longitudinal connector

For the electrical connection of two busbars, including infeed of up to three phases [3x 16A]



Flex connector

For the electrical connection of two busbars, equalises different height levels or angles in the busbar system



Mechanical connector

For the electrical separation of two different circuits within a track system



90° connector

For the electrical connection of two busbars across corners, with interchangeable mechanism for changing direction L/R



T-connector

For the electrical connection of three busbars, with changeover mechanism for changing direction L/R



X-connector

For the electrical connection of four busbars





FACADO II

FACADO II is our flexible solution for outdoor lighting - either as a bollard light or as a wall light. In both versions, the IP65 luminaires made of robust die-cast aluminium offer a wide range of optical options: angular or round shape, with opal or transparent diffuser in smoked glass look, in the housing colours dark grey or rust. The FACADO II bollard luminaires are also available in two different sizes [650 mm / 1,000 mm]. For even more flexibility, the FACADO II has an E27 socket for interchangeable light sources.

Both FACADO II versions enable quick and easy installation: the wall luminaires have a removable mounting plate with plug-in connection and screwless connection terminals. The bollard luminaires are supplied with an IP67 connection box with double M20 cable gland, which is suitable for underground cables with 3x 1.5 mm², 5x 1.5 mm² or 3x 2.5 mm², among others. All FACADO II luminaires can also be through-wired.

All information on the FACADO II series can be found from page 406 onwards.



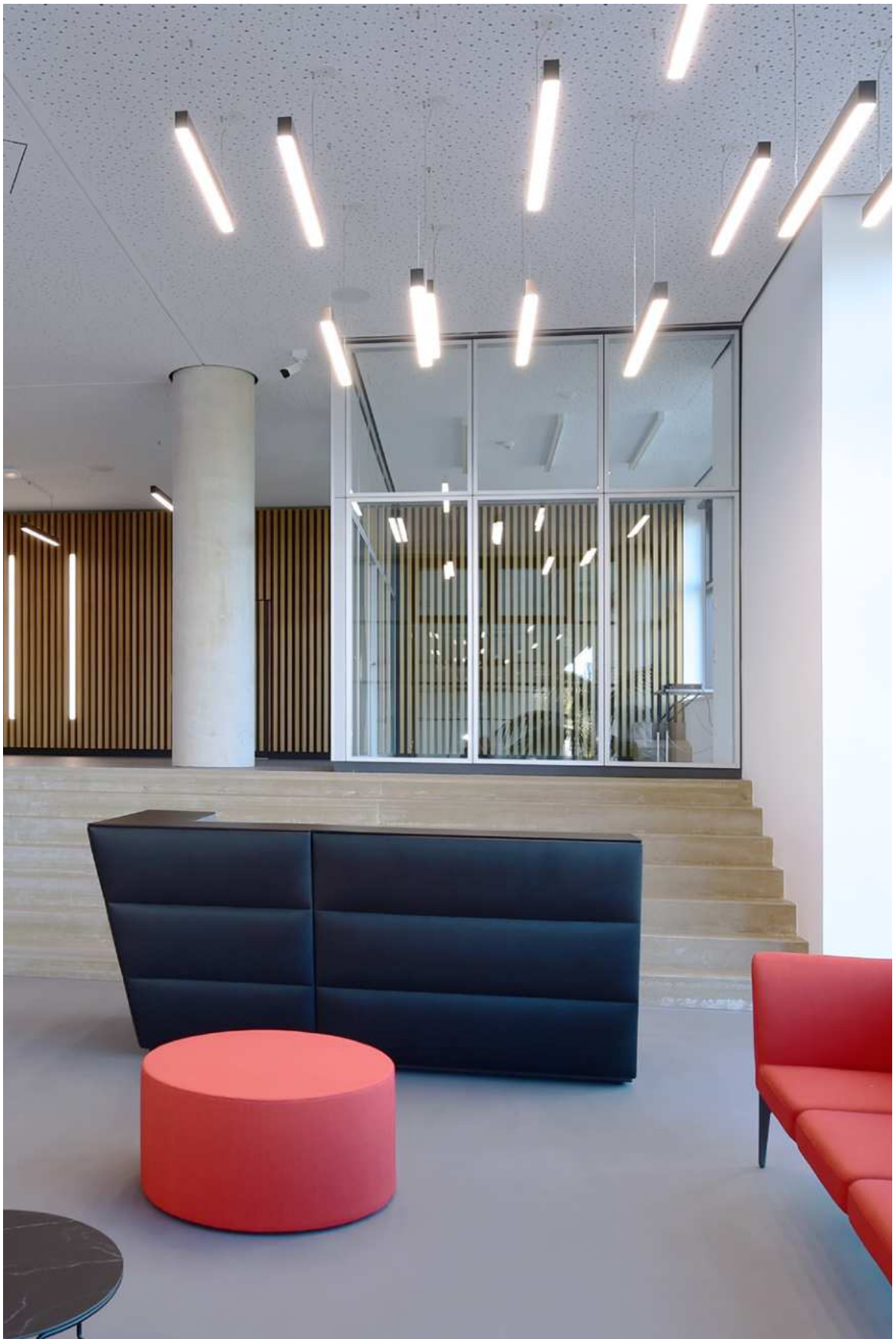

PLANO

The PLANO series is more than just another combination of profile and LED stripe and is produced entirely in Europe. The linear lighting solutions are based on four different profiles with LED equipment, surrounded by an aluminium corpus. PLANO can be individually configured in terms of length, lamps, colour temperature and body design. There are thus hardly any limits to the possible applications - whether in offices, schools, private homes, shops, showrooms and many more.

- individually plannable
- flexible in use
- manufactured in Europe

individual solution

A PLANO profile luminaire always has the same design - and yet it is individual. Inside sits a profile with LED illumination in 2,700, 3,000 or 4,000 K. The surrounding luminaire body is made of extruded aluminum and has an anodized or powder-coated surface. You can individually determine the length, equipment as well as the basic shape of the body, because the PLANO series is an individual lighting solution.

All information on the PLANO series can be found from page 526 onwards.

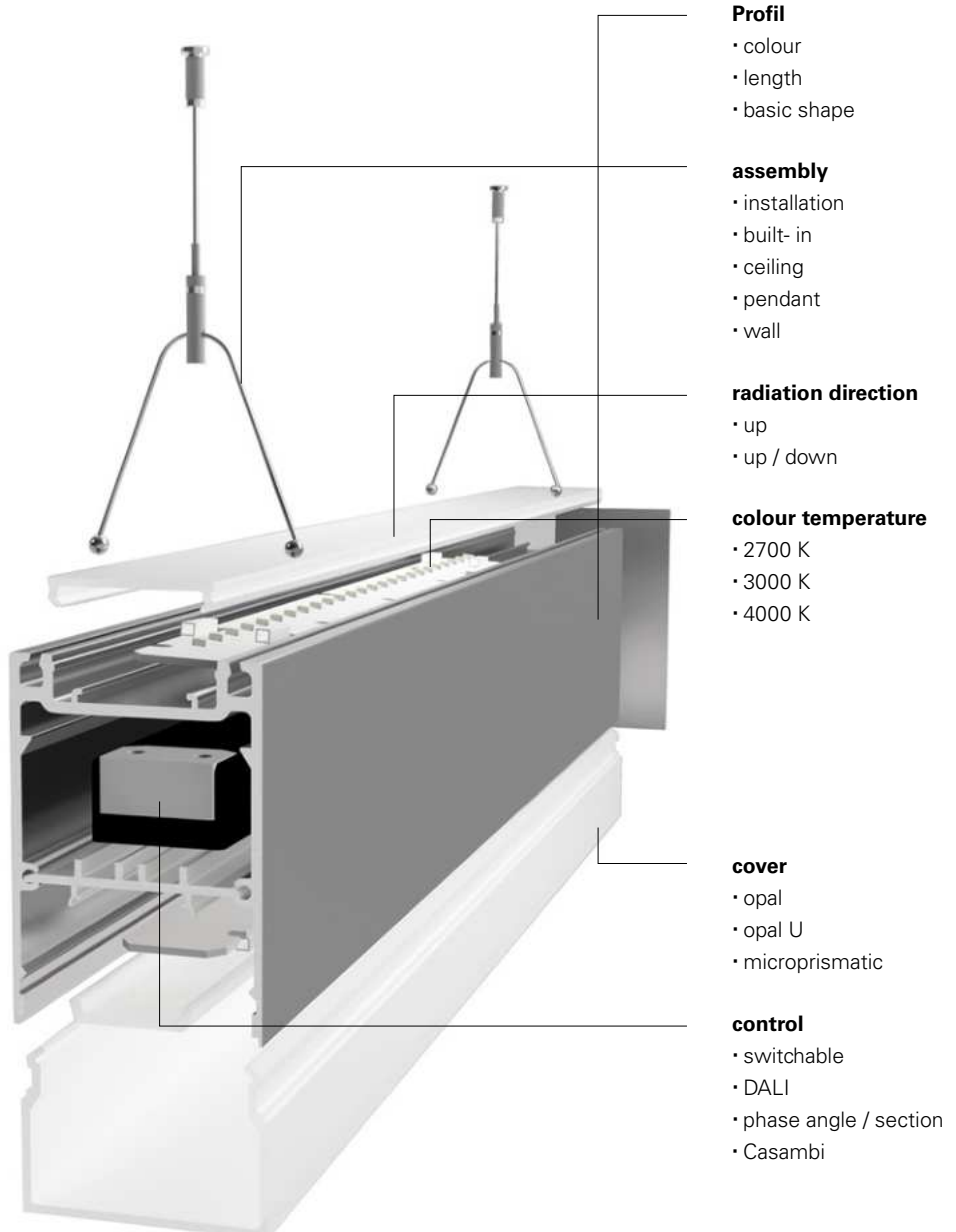

COMBO

COMBO is a new, easy-to-install profile-in-profile solution for the recessed use of light lines in façades, gardens, living spaces and more. The linear system solution can be integrated into all common building materials – from exposed concrete to brick, solid thermal insulation to wood and plasterboard – and is available in three versions: COMBO CONCRETE, COMBO DRY CONSTRUCTION and COMBO INSULATION, each as a mounting profile and as a transformer profile for integrated mounting of the LED transformer. Once the COMBO base profile has been installed, the PLANO KLICK luminaire insert profile is simply and easily clipped into the respective mounting profile.



All information on the COMBO series can be found from page 554 onwards.

PROFILE-IN-PROFILE VARIANTS

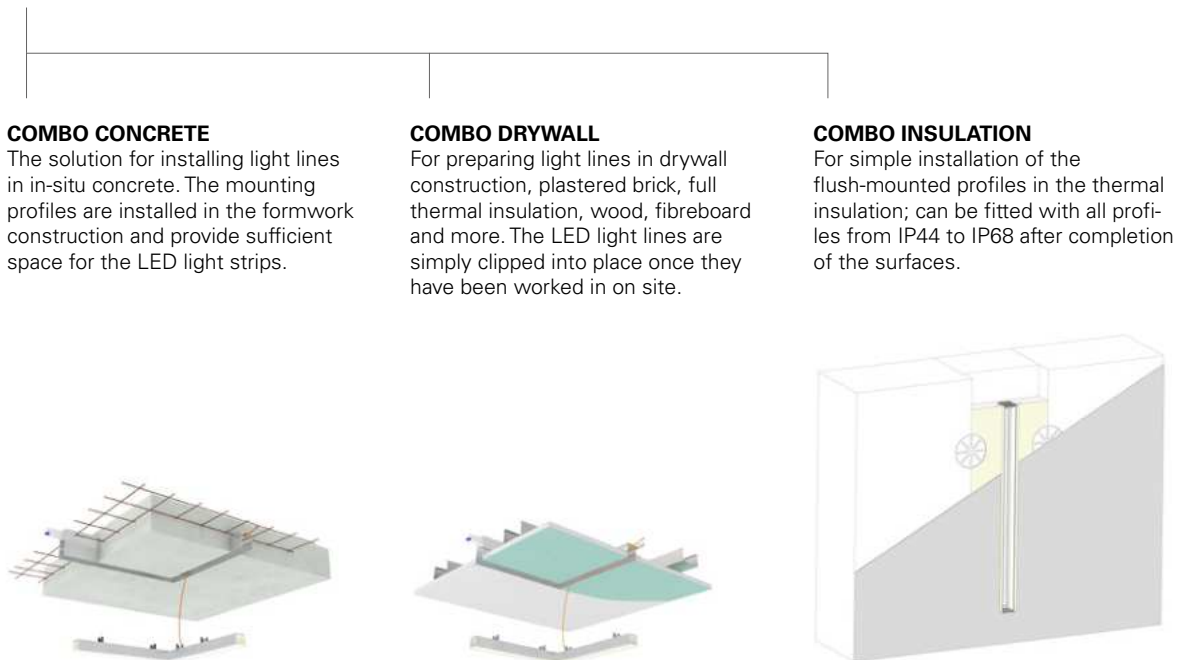

COMBO transformer profiles

For all three COMBO variants [CONCRETE, DRY CONSTRUCTION, INSULATION], DEKO-LIGHT offers a suitable transformer profile for accommodating the LED transformers in order to conceal the power supply unit behind the luminaire in the case of long light lines or different wiring.

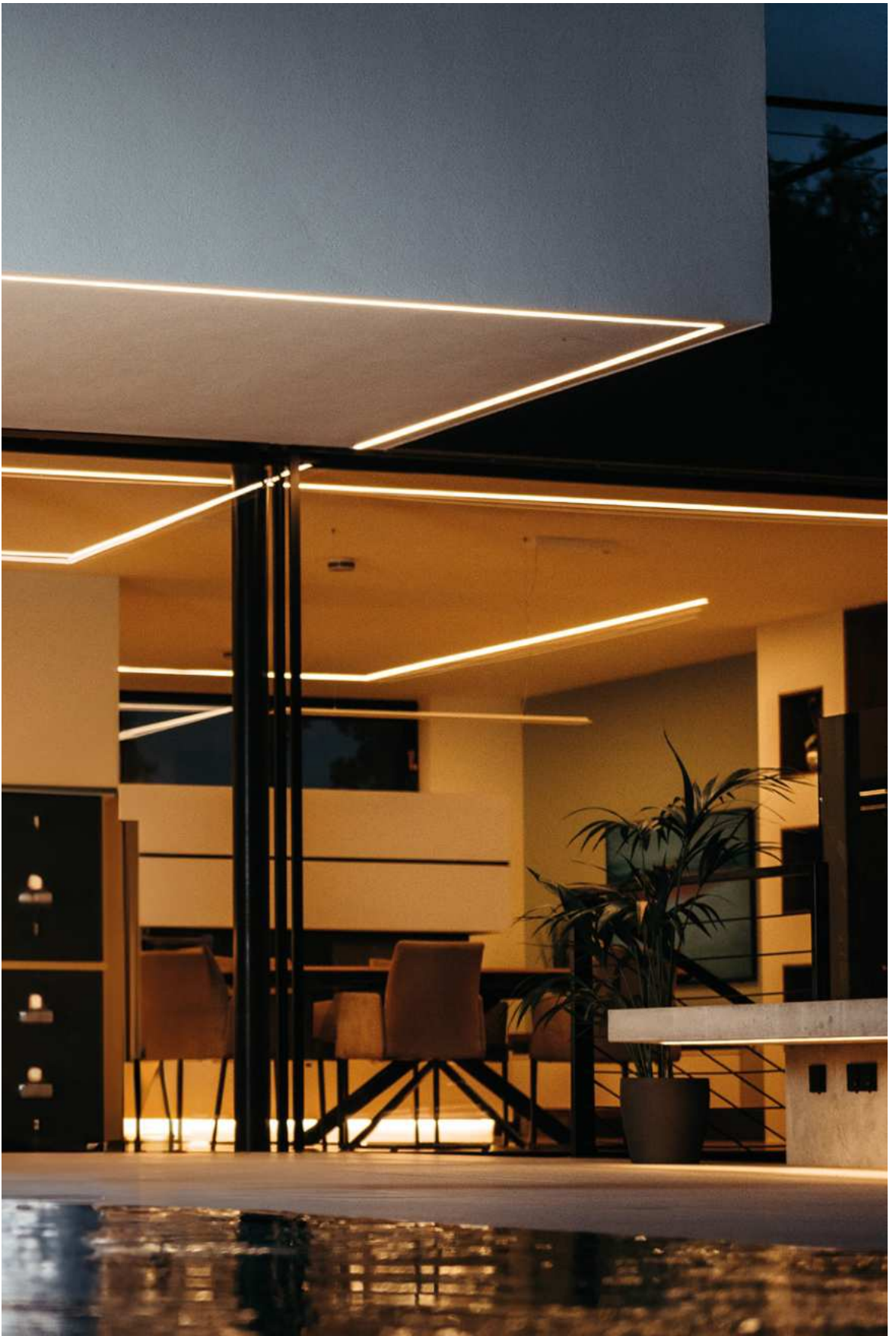



Copyright: mediahain.de / #599037239 / stock.adobe.com

RF-SMART

RF-smart is a multifunctional control system that combines quick and easy installation with maximum control convenience. RF-smart requires only a few basic components and can be used in a wide variety of applications. These range from commercial applications to company buildings and private homes.

RF-SMART COMPONENTS



Remote controls

The remote controls can be used to control the components on different channels in one or more zones [max. 8]. The remote controls are available as mobile versions or for wall mounting.



Repeater

The repeater can be used to extend the wireless range of the remote controls by up to 30 metres.



Light source

The LED retrofit light sources are equipped with an RF-smart radio module and fit into the standard GU10 and E27 sockets.



Lights

The RF-smart luminaires [FLOOD and SPOT] are equipped with a ZigBee-compatible wireless module and can therefore also be controlled via the market-leading smart home systems from Amazon, Google and others.



Triac dimmer

The triac dimmer works with trailing edge phase dimming and enables the switching and / or dimming of devices with 230V mains voltage. The triac dimmer is also available as an IP67 version for outdoor applications.



LED dimmer

The LED dimmer can be used to control LED strips with 1-5 channels and 12V to 48V voltage. The LED dimmer is also available as an IP67 version for outdoor applications.

Simple installation

The installation and commissioning of RF-smart is extremely simple: after the electrical connection, all the necessary function tests can be carried out on the connected lights or devices. The two dimmer modules are seamlessly complemented by integrated push inputs. In most cases, this allows you to use an existing electrical installation, including the existing switch range, to switch the connected RF-smart dimmers on/off and, if necessary, dim them using standard push-buttons.

Unlimited control

Whether via smartphone, tablet or with your voice - you decide how to control the RF-smart components. ZigBee 3.0 offers comprehensive compatibility with apps from different providers for an almost limitless range of applications.

All information on the RF-SMART series can be found from page 812 onwards.



INTERIOR LIGHTS

- 34 pendant lights
- 56 surface mounted ceiling lights
- 98 built in ceiling lights
- 148 insert panels
- 170 surface mounted wall lights
- 184 built in wall lights
- 190 reading lights
- 196 table and floor lights
- 204 showcase lights
- 212 office lights
- 236 hall floodlight
- 242 damp-proof luminaires

pendant lights



□ ■ □ ■
page 36



□ ■ □ ■
page 38



□ ■
page 40



■ □
page 42



■ □
page 44



□ ■
page 46



□ ■
page 48



□ ■
page 49



□ ■
page 51



■ □
page 52



■ ■
page 54





MENKAR

MENKAR series pendant lamps feature clever lighting functions and high-quality aluminium accents. The separate rear light (approx. 15-20 % indirect light) allows permanent indirect lighting.



page 58





MENKAR

- Indirect and direct lighting
- High light intensity
- Light colour adjustable in two stages
- Suspension up to 1800/3000 mm [depending on model]
- optionally with diffusing disc for UGR<19

Housing	Aluminium	Power Supply Unit incl.	Yes
Colour Temperature	3000/4000 K	Control	Leading-edge dimmer, Trailing-edge dimmer
Rated Input Voltage	220-240 V/AC	Colour Rendering Index (Ra)	80
Height	90 mm		
Base Height	30 mm		

Article	Housing Color		Luminous Flux	Power	Ø	Pendulum Length	Base Ø	Price
342201	<input type="checkbox"/> White		3300/3500 lm	45.0 W	400 mm	1800 mm	100 mm	€ 239.95
342202	<input checked="" type="checkbox"/> Black		3300/3500 lm	45.0 W	400 mm	1800 mm	100 mm	€ 239.95
342203	<input type="checkbox"/> Silver		3300/3500 lm	45.0 W	400 mm	1800 mm	100 mm	€ 239.95
342204	<input type="checkbox"/> Coffee		3300/3500 lm	45.0 W	400 mm	1800 mm	100 mm	€ 239.95
342205	<input type="checkbox"/> White		5600/6000 lm	65.0 W	600 mm	1800 mm	120 mm	€ 399.95
342206	<input checked="" type="checkbox"/> Black		5600/6000 lm	65.0 W	600 mm	1800 mm	120 mm	€ 399.95
342207	<input type="checkbox"/> Silver		5600/6000 lm	65.0 W	600 mm	1800 mm	120 mm	€ 399.95
342208	<input type="checkbox"/> Coffee		5600/6000 lm	65.0 W	600 mm	1800 mm	120 mm	€ 399.95
342209	<input type="checkbox"/> White		8400/8700 lm	90.0 W	800 mm	3000 mm	150 mm	€ 559.95
342210	<input checked="" type="checkbox"/> Black		8400/8700 lm	90.0 W	800 mm	3000 mm	150 mm	€ 559.95
342211	<input type="checkbox"/> Silver		8400/8700 lm	90.0 W	800 mm	3000 mm	150 mm	€ 559.95
342212	<input type="checkbox"/> Coffee		8400/8700 lm	90.0 W	800 mm	3000 mm	150 mm	€ 559.95



Accessories for **342201, 342202, 342203, 342204**

930709 Diffusing disc UGR 19 for Menkar 400



Accessories for **342205, 342206, 342207, 342208**

930710 Diffusing disc UGR 19 for Menkar 600



Accessories for **342209, 342210, 342211, 342212**

930711 Diffusing disc UGR 19 for Menkar 800





MEROPE

The pendant lamps of the MEROPE series combine timeless elegance and subdued modernity. Available in the diameters 380, 580 and 780 mm, the light colour [3,000/4,000 K] can be selected before installation using a CCT switch. The outside is finished in brushed aluminium in the colours white, silver, coffee and black.



page 60





MEROPE

- Light colour adjustable in two stages
- Suspension up to 1800/3000 mm [depending on model]

Housing	Aluminium	Power Supply Unit incl.	Yes
Colour Temperature	3000/4000 K	Control	Leading-edge dimmer, Trailing-edge dimmer
Rated Input Voltage	220-240 V/AC		
Height	35 mm	Colour Rendering Index (Ra)	80
Base Height	65 mm		

Article	Housing Color		Luminous Flux	Power	Ø	Pendulum Length	Base Ø	Price
342189	White	ww nw	2100/2200 lm	30.0 W	380 mm	1800 mm	220 mm	€ 209.95
342190	Black	ww nw	2100/2200 lm	30.0 W	380 mm	1800 mm	220 mm	€ 209.95
342191	Silver	ww nw	2100/2200 lm	30.0 W	380 mm	1800 mm	220 mm	€ 209.95
342192	Coffee	ww nw	2100/2200 lm	30.0 W	380 mm	1800 mm	220 mm	€ 209.95
342193	White	ww nw	3100/3200 lm	42.0 W	580 mm	1800 mm	220 mm	€ 279.95
342194	Black	ww nw	3100/3200 lm	42.0 W	580 mm	1800 mm	220 mm	€ 279.95
342195	Silver	ww nw	3100/3200 lm	42.0 W	580 mm	1800 mm	220 mm	€ 279.95
342196	Coffee	ww nw	3100/3200 lm	42.0 W	580 mm	1800 mm	220 mm	€ 279.95
342197	White	ww nw	4800/4900 lm	60.0 W	780 mm	3000 mm	275 mm	€ 469.95
342198	Black	ww nw	4800/4900 lm	60.0 W	780 mm	3000 mm	275 mm	€ 469.95
342199	Silver	ww nw	4800/4900 lm	60.0 W	780 mm	3000 mm	275 mm	€ 469.95
342200	Coffee	ww nw	4800/4900 lm	60.0 W	780 mm	3000 mm	275 mm	€ 469.95





SCULPTORIS

SCULPTORIS series pendant lamps boast an impressive matte visual design and luminous ring. With high luminous intensity and large light emission angle, the series offers flexible applications in many different areas, whether in living areas or for providing imposing lighting solutions to office spaces.





SCULPTORIS

- light colour adjustable in two levels
- all-round diffuser
- suspension up to 1800/3000 mm [depending on model]

Housing	Aluminium	Light Beam Angle	150 Degree
Colour Temperature	3000/4000 K	Control	Leading-edge dimmer, Trailing-edge dimmer
Rated Input Voltage	220-240 V/AC	Colour Rendering Index (Ra)	80
Base Height	65 mm		
Power Supply Unit incl.	Yes		

Article	Housing Color		Luminous Flux	Power	Height	Ø	Pendulum Length	Price
342183	<input type="checkbox"/> White		2000/2100 lm	30.0 W	85 mm	400 mm	1800 mm	€ 289.95
342184	<input checked="" type="checkbox"/> Black		2000/2100 lm	30.0 W	85 mm	400 mm	1800 mm	€ 289.95
342185	<input type="checkbox"/> White		3000/3100 lm	42.0 W	110 mm	600 mm	1800 mm	€ 369.95
342186	<input checked="" type="checkbox"/> Black		3000/3100 lm	42.0 W	110 mm	600 mm	1800 mm	€ 369.95
342187	<input type="checkbox"/> White		4100/4200 lm	60.0 W	110 mm	800 mm	3000 mm	€ 569.95
342188	<input checked="" type="checkbox"/> Black		4100/4200 lm	60.0 W	110 mm	800 mm	3000 mm	€ 569.95





page 285



page 382



SLIM ANGULAR

- extra-soft fabric cable
- glare-free thanks to low UGR value (<19)
- slim design with just 39 mm diameter
- incl. silver-coloured reflector ring

Housing	Aluminium	Base Width	80 mm
Colour Temperature	2700 K	Base Height	26 mm
Luminous Flux	1500 lm	Power Supply Unit incl.	Yes
Power	15 W	Light Beam Angle	24 Degree
Rated Input Voltage	220-240 V/AC	Control	Leading-edge dimmer, Trailing-edge dimmer
Height	300 mm	Colour Rendering Index (Ra)	90
Ø	39 mm		
Pendulum Length	1800 mm		
Base Length	370 mm		

Article	Housing Color		Price
342239	Black		€ 209.95
342240	White		€ 209.95



Accessories

930744	Reflector-ring white for series Slim		€ 4.95
930745	Reflector-ring black for series Slim		€ 4.95
930746	Reflector-ring gold for series Slim		€ 5.95
930748	Lense 36° for series Slim		€ 4.95
930749	Lense 60° for series Slim		€ 4.95

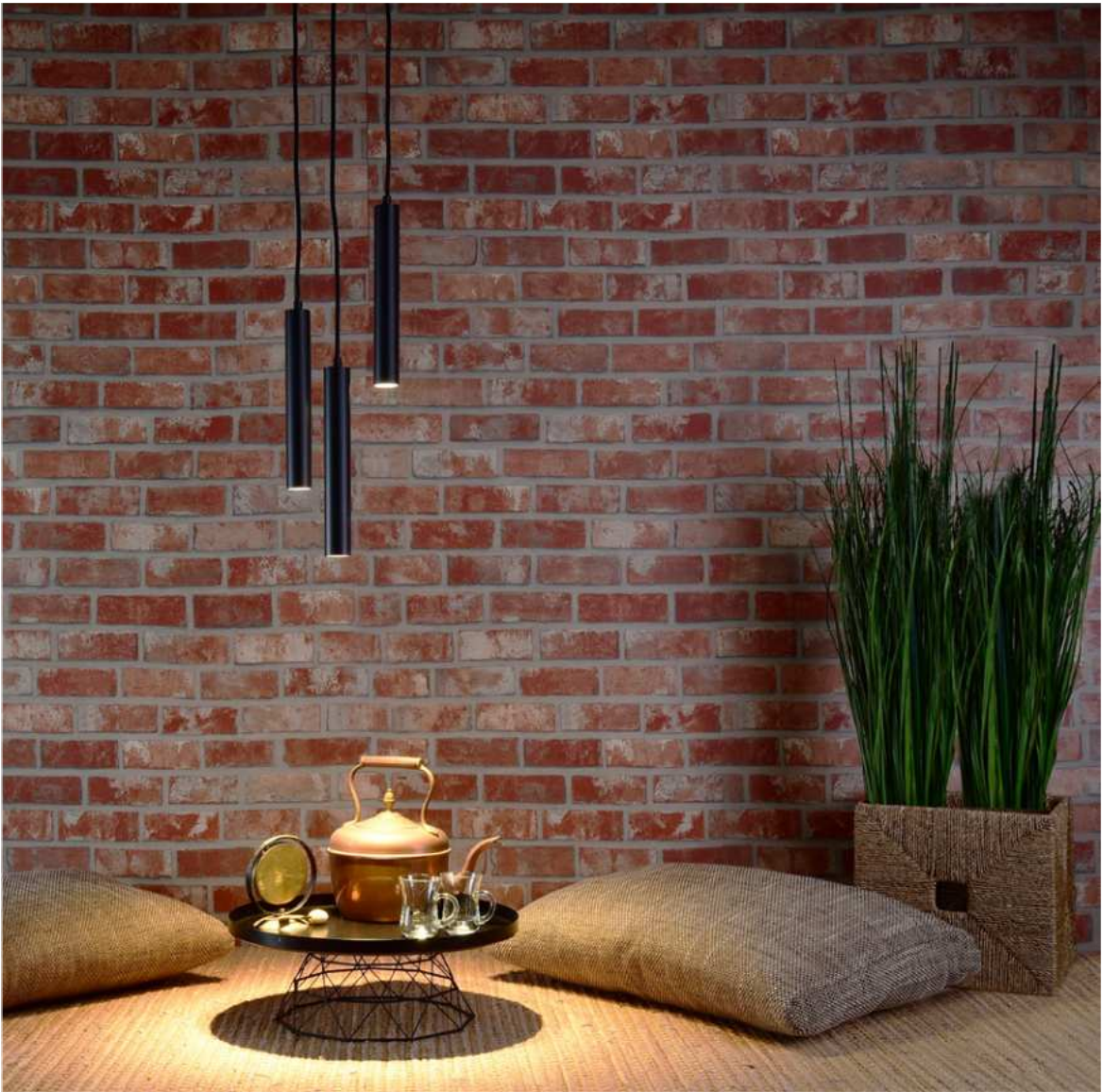

SLIM ROUND

SLIM series lights include single-luminaire and triple-luminaire pendant lamps and matching pendant lamps for the DEKO-LIGHT current track system. The light body in die-cast aluminium is always the same size [300 x 39 mm]. Several SLIM models therefore can also be combined with each other in larger spaces. The pendant lamps for ceiling installation with max. 180 cm suspended mounting are available in a one or three-luminaire variant; three-luminaire variant both with long or round base depending on the arrangement of the lights.

Whilst fixed SLIM models immerse dining tables, reading corners and more in a pleasantly warm white light, the single-luminaire SLIM current track light is especially well suited to gastronomy and retail projects with variable room layouts. The value of the Slim series is rounded off with a flexible fabric cable.



page 285



page 382



SLIM ROUND





- Extra-soft fabric cable
- Glare-free thanks to low UGR value [<19]
- Slim design with only 39 mm diameter
- Incl. silver-coloured reflector ring

Housing	Aluminium	Power Supply Unit incl.	Yes
Colour Temperature	2700 K	Light Beam Angle	24 Degree
Rated Input Voltage	220-240 V/AC	Control	Leading-edge dimmer, Trailing-edge dimmer
Height	300 mm	Colour Rendering Index (Ra)	90
Ø	39 mm		
Pendulum Length	1800 mm		
Base Height	25 mm		

Article	Housing Color		Luminous Flux	Power	Base Ø	Price
342237	■ Black	ww	500 lm	5.0 W	100 mm	€ 84.95
342238	□ White	ww	500 lm	5.0 W	100 mm	€ 84.95
342241	■ Black	ww	1500 lm	15.0 W	240 mm	€ 209.95
342242	□ White	ww	1500 lm	15.0 W	240 mm	€ 209.95



Accessories

930744	Reflector-ring white for series Slim		€ 4.95
930745	Reflector-ring black for series Slim		€ 4.95
930746	Reflector-ring gold for series Slim		€ 5.95
930748	Lense 36° for series Slim		€ 4.95
930749	Lense 60° for series Slim		€ 4.95



LUCEA CCT

- Particularly soft textile cable
- Light colour adjustable in two levels
- incl. black reflector ring

Housing	Aluminium	Power Supply Unit incl.	Yes
Colour Temperature	3000/4000 K	Light Beam Angle	36 Degree
Rated Input Voltage	220-240 V/AC	Control	Leading-edge dimmer, Trailing-edge dimmer
Pendulum Length	1800 mm	Colour Rendering Index (Ra)	90
Base Ø	104.5 mm		
Base Height	29 mm		

Article	Housing Color		Luminous Flux	Power	Height	Ø	Price
342177	<input type="checkbox"/> White		930/1000 lm	10.0 W	157 mm	65 mm	€ 139.95
342178	<input checked="" type="checkbox"/> Black		930/1000 lm	10.0 W	157 mm	65 mm	€ 139.95
342179	<input type="checkbox"/> White		1460/1500 lm	15.0 W	178 mm	85 mm	€ 159.95
342180	<input checked="" type="checkbox"/> Black		1460/1500 lm	15.0 W	178 mm	85 mm	€ 159.95
342181	<input type="checkbox"/> White		1930/2000 lm	20.0 W	178 mm	85 mm	€ 179.95
342182	<input checked="" type="checkbox"/> Black		1930/2000 lm	20.0 W	178 mm	85 mm	€ 179.95



Accessories for **342177, 342178**

930679	Lenze 24° for Lucea 6/10 W		€ 9.95
930752	Blind cover for Lucea 6/10 white		€ 22.95
930753	Blind cover for Lucea 6/10 black		€ 22.95
930756	Reflector ring for Lucea 6/10 white		€ 4.95
930757	Reflector ring for Lucea 6/10 black		€ 4.95
930758	Reflector ring for Lucea 6/10 Gold		€ 4.95

Accessories for **342179, 342180, 342181, 342182**

930680	Lenze 24° for Lucea 15/20		€ 12.95
930681	Lenze 60° for Lucea 15/20		€ 12.95
930754	Blind cover for Lucea 15/20 white		€ 23.95
930755	Blind cover for Lucea 15/20 black		€ 23.95
930759	Reflector ring for Lucea 15/20 white		€ 5.95
930760	Reflector ring for Lucea 15/20 black		€ 5.95
930761	Reflector ring for Lucea 15/20 Gold		€ 5.95



page 80



page 82



page 374



page 378



Technical data sheet

New in the onlineshop: The technical data sheets offer even more information: Light and energy data, light distribution curves, dimensional drawings and more.



LUCEA

- particularly soft textile cable
- incl. black reflector ring

Housing	Aluminium	Base Height	29 mm
Colour Temperature	2700 K	Power Supply Unit incl.	Yes
Rated Input Voltage	200-240 V/AC	Light Beam Angle	36 Degree
Height	157 mm	Control	Leading-edge dimmer, Trailing-edge dimmer
Ø	65 mm	Colour Rendering Index (Ra)	90
Pendulum Length	1800 mm		
Base Ø	104.5 mm		

Article	Housing Color	Luminous Flux	Power	Price
342243	<input type="checkbox"/> White	800 lm	6.0 W	€ 129.95
342244	<input checked="" type="checkbox"/> Black	800 lm	6.0 W	€ 129.95
342245	<input type="checkbox"/> White	1300 lm	10.0 W	€ 139.95
342246	<input checked="" type="checkbox"/> Black	1300 lm	10.0 W	€ 139.95



Accessories

930679	Lense 24° for Lucea 6/10 W		€ 9.95
930752	Blind cover for Lucea 6/10 white		€ 22.95
930753	Blind cover for Lucea 6/10 black		€ 22.95
930756	Reflector ring for Lucea 6/10 white		€ 4.95
930757	Reflector ring for Lucea 6/10 black		€ 4.95
930758	Reflector ring for Lucea 6/10 Gold		€ 4.95





LUCEA DTW

- high colour rendering
- Dim-to-warm 1,800K-2,700K
- incl. black reflector ring

Housing	Aluminium	Pendulum Length	1800 mm
Colour Temperature	1800-2700 K	Power Supply Unit incl.	Yes
Luminous Flux	750 lm	Light Beam Angle	36 Degree
Power	10 W	Control	Leading-edge dimmer, Trailing-edge dimmer
Rated Input Voltage	200-240 V/AC	Colour Rendering Index (Ra)	90
Height	157 mm		
Ø	65 mm		

Article	Housing Color		Price
342247	<input type="checkbox"/> White		€ 149.95
342248	<input checked="" type="checkbox"/> Black		€ 149.95



Accessories

930752	Blind cover for Lucea 6/10 white		€ 22.95
930753	Blind cover for Lucea 6/10 black		€ 22.95
930756	Reflector ring for Lucea 6/10 white		€ 4.95
930757	Reflector ring for Lucea 6/10 black		€ 4.95
930758	Reflector ring for Lucea 6/10 Gold		€ 4.95



page 80



page 82



page 374



page 378





CAN

- customised lighting solution thanks to replaceable light source
- can be combined with the product family of the CAN series

Housing	Aluminium	Sockets	1
Ø	60 mm	Max. Power	1x max. 7.5 W
Pendulum Length	1500 mm	Rated Input Voltage	220-240 V/AC
Base Height	27 mm	Control	Dimmable via optional light source
Base Ø	60 mm		

Article	Housing Color	Height	Price
342254	<input type="checkbox"/> White	150 mm	€ 64.95
342255	<input checked="" type="checkbox"/> Black	150 mm	€ 64.95
342256	<input type="checkbox"/> White	350 mm	€ 74.95
342257	<input checked="" type="checkbox"/> Black	350 mm	€ 74.95



page 88



page 90



page 180



page 181



page 194



page 195



page 364



Light sources

For all lights and bases:

You can find the right light sources in the »Light sources« section.



APOLLON

The APOLLON narrow, puristic pendant lamp fits into almost any environment seamlessly and in addition to the elegant visual design also delivers a rich warm white light. The APOLLON is available in two different sizes with a matte surface in black and white.



APOLLON

- Particularly narrow design
- High colour reproduction
- Including uplight for indirect light
- Suspended mounting up to max. 3,000 mm
- Dimmable

Housing	Aluminium	Base Height	48 mm
Colour Temperature	2700 K	Power Supply Unit incl.	Yes
Rated Input Voltage	200-250 V/AC	Light Beam Angle	110 Degree
Width	8 mm	Control	Leading-edge dimmer, Trailing-edge dimmer
Height	80 mm	Colour Rendering Index (Ra)	90
Pendulum Length	3000 mm		
Base Width	35 mm		

Article	Housing Color		Luminous Flux	Power	Length	Base Length	EEL	Price
342148	Black	ww	1755 lm	28.0 W	1004 mm	650 mm		€ 329.95
342149	White	ww	1755 lm	28.0 W	1004 mm	650 mm		€ 329.95
342150	Black	ww	2475 lm	42.0 W	1464 mm	850 mm		€ 439.95
342151	White	ww	2475 lm	42.0 W	1464 mm	850 mm		€ 439.95





MADERA

The MADERA pendant lamp combines modern design with environmentally friendly manufacturing. Every light is manufactured from high-quality European oak with FSC certification and therefore comes from sustainable forestry. You can dim the brightness of the light however you like using the touch sensor on the side, creating a pleasant atmosphere. They are also available in the variant with indirect upward lighting and a cable for height adjustment so you can adjust the light perfectly at any time. The MADERA pendant lamps have environmentally friendly packaging to protect our environment.



page 94



page 182



page 202



page 203



MADERA

- Manufactured in Europe from high-quality, oiled quality class A oak
- FSC-certified oak raw material from sustainable forestry sources
- Infinitely dimmable using touch sensor
- Height adjustable using cable
- Incl. uplight [342235, 342236 only]

Housing	Wood, Steel	Base Width	66 mm
Colour Temperature	3000 K	Base Height	56 mm
Rated Input Voltage	220-240 V/AC	Power Supply Unit incl.	Yes
Width	42 mm	Control	Touch-Sensor
Height	60 mm	Colour Rendering Index (Ra)	85
Pendulum Length	1000 mm		
Base Length	372 mm		

Article	Housing Color	Luminous Flux	Power	Length	Light Direction	Price
342234	■ Brown, Black	1600 lm	13.0 W	900 mm	Below	€ 579.95
342235	■ Brown, Black	2890 lm	22.0 W	1200 mm	Top / Below	€ 719.95
342236	■ Brown, Black	4400 lm	33.0 W	1600 mm	Top / Below	€ 839.95



surface mounted ceiling lights



page 58



page 60



page 62

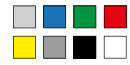

page 64



page 66



page 66



page 68



page 70



page 72



page 74



page 76



page 77



□ ■
page 78



□ ■
page 80



□ ■
page 82



□ ■
page 84



□ ■
page 85



□ ■
page 86



□ ■
page 87



□ ■
page 88



□ ■
page 88



□ ■
page 90



□ ■
page 91



□ ■ □
page 92



□ ■ □
page 92



□ ■
page 93



■ ■
page 94



■ ■
page 94



□ □
page 96



MENKAR

The ceiling and wall lights in the MENKAR series impress with their clever lighting functions and high-quality aluminium accents. The rear light (approx. 15 - 20 % indirect light component) provides additional indirect lighting.



page 36





MENKAR

- Direct and indirect lighting [light component approx. 15 - 20%]
- Light colour adjustable in two levels
- Optionally with diffusing disc for UGR<19
- Can be used as a wall and ceiling light [depending on model]

Housing	Aluminium, Polycarbonate, Steel	Control	Leading-edge dimmer, Trailing-edge dimmer
Colour Temperature	3000/4000 K	Colour Rendering Index (Ra)	80
Height	90 mm		
Rated Input Voltage	220-240 V/AC		
Power Supply Unit incl.	Yes		

Article	Housing Color		Luminous Flux Surface	Ø	Power	Price
348200	Silver		3300/3500 lm Brushed	400 mm	45.0 W	€ 219.95
348201	Coffee		3300/3500 lm Brushed	400 mm	45.0 W	€ 219.95
348198	White		3300/3500 lm Matt	400 mm	45.0 W	€ 219.95
348199	Black		3300/3500 lm Matt	400 mm	45.0 W	€ 219.95
348204	Silver		5600/6000 lm Brushed	600 mm	65.0 W	€ 379.95
348205	Coffee		5600/6000 lm Brushed	600 mm	65.0 W	€ 379.95
348202	White		5600/6000 lm Matt	600 mm	65.0 W	€ 379.95
348203	Black		5600/6000 lm Matt	600 mm	65.0 W	€ 379.95
348208	Silver		8400/8700 lm Brushed	800 mm	90.0 W	€ 539.95
348209	Coffee		8400/8700 lm Brushed	800 mm	90.0 W	€ 539.95
348206	White		8400/8700 lm Matt	800 mm	90.0 W	€ 539.95
348207	Black		8400/8700 lm Matt	800 mm	90.0 W	€ 539.95



Accessories for **348198, 348199, 348200, 348201**

930709 Diffusing disc UGR 19 for Menkar 400



Accessories for **348202, 348203, 348204, 348205**

930710 Diffusing disc UGR 19 for Menkar 600



Accessories for **348206, 348207, 348208, 348209**

930711 Diffusing disc UGR 19 for Menkar 800





MEROPE

The timeless MEROPE demonstrates not only impressively high luminous flux and a low assembly height, it is also highly visually appealing thanks to its elegant outer aluminium ring – available in sandblasted white or black, brushed in silver or on-trend coffee. Available in the diameters 380 mm, 580 mm and 780 mm, the MEROPE can be integrated into very different environments even more flexibly.



page 38





MEROPE

- Light colour adjustable in two stages
- Low installation height

Housing	Aluminium	Control	Leading-edge dimmer, Trailing-edge dimmer
Colour Temperature	3000/4000 K		
Height	60 mm		
Rated Input Voltage	220-240 V/AC	Colour Rendering Index (Ra)	80
Power Supply Unit incl.	Yes		

Article	Housing Color		Luminous Flux	Surface	Ø	Power	Price
348188	Silver	WW NW	2100/2200 lm	Brushed	380 mm	30.0 W	€ 189.95
348189	Coffee	WW NW	2100/2200 lm	Brushed	380 mm	30.0 W	€ 189.95
348186	White	WW NW	2100/2200 lm	Matt	380 mm	30.0 W	€ 189.95
348187	Black	WW NW	2100/2200 lm	Matt	380 mm	30.0 W	€ 189.95
348192	Silver	WW NW	3100/3200 lm	Brushed	580 mm	42.0 W	€ 269.95
348193	Coffee	WW NW	3100/3200 lm	Brushed	580 mm	42.0 W	€ 269.95
348190	White	WW NW	3100/3200 lm	Matt	580 mm	42.0 W	€ 269.95
348191	Black	WW NW	3100/3200 lm	Matt	580 mm	42.0 W	€ 269.95
348196	Silver	WW NW	4800/4900 lm	Brushed	780 mm	60.0 W	€ 449.95
348197	Coffee	WW NW	4800/4900 lm	Brushed	780 mm	60.0 W	€ 449.95
348194	White	WW NW	4800/4900 lm	Matt	780 mm	60.0 W	€ 449.95
348195	Black	WW NW	4800/4900 lm	Matt	780 mm	60.0 W	€ 449.95





SCULPTORIS

Modern elegance for ceilings; the ceiling lights from the SCULPTORIS series can be used in a number of ways indoors thanks to different outputs, sizes and colour temperatures. The surface-mounted ceiling lights provide extensive illumination for rooms and also look great as wall lights.

The light is softly and extensively diffused through the large, circumferential diffuser with matt aluminium design and illuminates rooms pleasantly and evenly.

The light colours warm white (3,000 K) or neutral white (4,000 K) can be set for each variant.



page 40





SCULPTORIS

- Light colour adjustable in 2 stages
- Uniform illumination
- Circumferential diffuser

Housing	Aluminium	Light Beam Angle	150 Degree
Colour Temperature	3000/4000 K	Control	Leading-edge dimmer, Trailing-edge dimmer
Surface	Matt	Colour Rendering Index (Ra)	80
Rated Input Voltage	220-240 V/AC		
Power Supply Unit incl.	Yes		

Article	Housing Color		Luminous Flux	Height	Ø	Power	Price
348180	<input type="checkbox"/> White		2000/2100 lm	100 mm	400 mm	30.0 W	€ 269.95
348181	<input checked="" type="checkbox"/> Black		2000/2100 lm	100 mm	400 mm	30.0 W	€ 269.95
348182	<input type="checkbox"/> White		3000/3100 lm	130 mm	600 mm	42.0 W	€ 349.95
348183	<input checked="" type="checkbox"/> Black		3000/3100 lm	130 mm	600 mm	42.0 W	€ 349.95
348184	<input type="checkbox"/> White		4100/4200 lm	130 mm	800 mm	60.0 W	€ 579.95
348185	<input checked="" type="checkbox"/> Black		4100/4200 lm	130 mm	800 mm	60.0 W	€ 579.95





ZANIAH

Whilst flat surfaces and covers are the go-to for most surface-mounted ceiling lights, the ZANIAH places special emphasis on its 360° lamp [either a 12W, 18W or 21W variant]. This isn't just for visual reasons, as the ZANIAH can be combined with covers from the similarly new ORBIT series if needed. This means that not only are different colours available - the ZANIAH itself comes in eight colour variants per performance class.



ZANIAH

- Can be customised with coloured covers
- 360° beam angle
- Can be used as a wall and ceiling light

Housing	Aluminium	Control	Leading-edge dimmer, Trailing-edge dimmer
Colour Temperature	3000 K	Colour Rendering Index (Ra)	80
Rated Input Voltage	220-240 V/AC	IK Protection Class	IK05
Power Supply Unit incl.	Yes		
Light Beam Angle	120 Degree		

Article	Housing Color		Luminous Flux	Height	Ø	Power	EEL	Price
620033	Silver		1510 lm	42 mm	290 mm	12.0 W		€ 99.95
620034	Blue		1510 lm	42 mm	290 mm	12.0 W		€ 99.95
620035	Green		1510 lm	42 mm	290 mm	12.0 W		€ 99.95
620036	Red		1510 lm	42 mm	290 mm	12.0 W		€ 99.95
620037	Yellow		1510 lm	42 mm	290 mm	12.0 W		€ 99.95
620038	Grey		1510 lm	42 mm	290 mm	12.0 W		€ 99.95
620039	Black		1510 lm	42 mm	290 mm	12.0 W		€ 99.95
620040	White		1510 lm	42 mm	290 mm	12.0 W		€ 99.95
620041	Silver		2020 lm	46 mm	370 mm	18.0 W		€ 109.95
620042	Blue		2020 lm	46 mm	370 mm	18.0 W		€ 109.95
620043	Green		2020 lm	46 mm	370 mm	18.0 W		€ 109.95
620044	Red		2020 lm	46 mm	370 mm	18.0 W		€ 109.95
620045	Yellow		2020 lm	46 mm	370 mm	18.0 W		€ 109.95
620046	Grey		2020 lm	46 mm	370 mm	18.0 W		€ 109.95
620047	Black		2020 lm	46 mm	370 mm	18.0 W		€ 109.95
620048	White		2020 lm	46 mm	370 mm	18.0 W		€ 109.95
620049	Silver		2565 lm	46 mm	420 mm	24.0 W		€ 119.95
620050	Blue		2565 lm	46 mm	420 mm	24.0 W		€ 119.95
620051	Green		2565 lm	46 mm	420 mm	24.0 W		€ 119.95
620052	Red		2565 lm	46 mm	420 mm	24.0 W		€ 119.95
620053	Yellow		2565 lm	46 mm	420 mm	24.0 W		€ 119.95
620054	Grey		2565 lm	46 mm	420 mm	24.0 W		€ 119.95
620055	Black		2565 lm	46 mm	420 mm	24.0 W		€ 119.95
620056	White		2565 lm	46 mm	420 mm	24.0 W		€ 119.95





ALTAIS

It takes a lot to catch the Altais series off guard. Thanks to IP54 and impact strength class IK10, these slender outdoor lamps are impressive all-rounders both in commercial and private settings. The adjustable light colour provides additional versatility for different lighting scenarios.





ALTAIS

- Light colour adjustable in three stages
- Optional surface-mounted cable insertion
- Through-wiring possible

Housing	Plastic	Light Beam Angle	120 Degree
Colour Temperature	3000/4000/6000 K	Colour Rendering Index (Ra)	85
Height	48 mm	IK Protection Class	IK10
Rated Input Voltage	220-240 V/AC		
Power Supply Unit incl.	Yes		

Article	Housing Color		Luminous Flux	Ø	Power	EEL	Price
348141	<input type="checkbox"/> White	WW NW CW	1260 lm	220 mm	12.0 W		€ 69.95
348143	<input type="checkbox"/> White	WW NW CW	1870 lm	280 mm	18.0 W		€ 89.95
348145	<input type="checkbox"/> White	WW NW CW	2715 lm	330 mm	25.0 W		€ 109.95



ALTAIS MOTION

- Light colour adjustable in three levels
- Optional surface-mounted cable insertion
- Through-wiring possible
- Motion detector adjustable via remote control [included]

Housing	Plastic	Light Beam Angle	120 Degree
Colour Temperature	3000/4000/6000 K	Colour Rendering Index (Ra)	85
Rated Input Voltage	220-240 V/AC	IK Protection Class	IK10
Power Supply Unit incl.	Yes		

Article	Housing Color		Luminous Flux	Height	Ø	Power	EEL	Price
348142	<input type="checkbox"/> White	WW NW CW	1260 lm	48 mm	220 mm	12.0 W		€ 114.95
348144	<input type="checkbox"/> White	WW NW CW	1870 lm	49 mm	280 mm	18.0 W		€ 129.95
348146	<input type="checkbox"/> White	WW NW CW	2715 lm	48 mm	330 mm	25.0 W		€ 149.95





HELEN

The 3-in-1 ceiling light - with the Helen, you get three lights in one. The LEDs can be switched from warm white to neutral white or cold white using a small switch on the printed circuit board. Thanks to IP54, the ceiling light is suitable for all areas of the home, such as the kitchen, bathroom, living areas and even outdoors. The same light in both the garage and kitchen? No problem with the Helen. Whilst you would probably prefer cold white in the garage, warm white is the top pick for living areas and usually neutral white in the kitchen and bathroom. All bases are covered with just one light.



HELEN

- Light colour adjustable in three stages
- Splash-proof

Housing	Plastic	Power Supply Unit incl.	Yes
Colour Temperature	3000/4000/5500 K	Light Beam Angle	115 Degree
Surface	Brushed	Colour Rendering Index (Ra)	80
Base Height	20 mm		
Rated Input Voltage	220-240 V/AC		

Article	Housing Color		Luminous Flux	Height	Ø	Base Ø	Power	Price
348051	Silver		1400 lm	83 mm	276 mm	251 mm	16.3 W	€ 79.95
348052	Silver		1800 lm	89 mm	351 mm	326 mm	20.0 W	€ 119.95

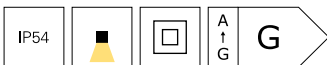

Onlineshop

You can find more information about the products in the onlineshop:
Detailed images, videos, project reports, LDT files, EPREL data sheets and more.



UNI II













- „Glow“ effect on the reflector ring
- Rotatable and swivelling
- Can be customised with a wide range of accessories

Housing	Aluminium	Rated Input Voltage	220-240 V/AC
Colour Temperature	3000 K	Power Supply Unit incl.	Yes
Luminous Flux	670 lm	Light Beam Angle	36 Degree
Height	103 mm	Swivelling Angle	90 Degree
Ø	100 mm	Control	Leading-edge dimmer, Trailing-edge dimmer
Base Height	14.5 mm		
Base Ø	96 mm	Colour Rendering Index (Ra)	90
Power	12 W		

Article	Housing Color		Price
348124	<input type="checkbox"/> White		€ 144.95
348179	<input checked="" type="checkbox"/> Black		€ 144.95



Accessories

930305	Reflector 36° for series Klara / Nihal Mini / Rigel Mini / Uni II		€ 3.6
930306	Reflector 48° for series Klara / Nihal Mini / Rigel Mini / Uni II		€ 8.95
930307	Honeycomb filter for series Klara / Nihal Mini / Rigel Mini / Uni II		€ 8.95
930308	Spread lense for series Klara / Nihal Mini / Rigel Mini / Uni II		€ 8.95
930309	Softening lense for series Klara / Nihal Mini / Rigel Mini / Uni II		€ 8.95
930310	Linear spread lense for series Klara / Nihal Mini / Rigel Mini / Uni II		€ 8.95
930334	Cover back white for series Uni II		€ 3.55
930335	Cover back black for series Uni II		€ 2.95
930336	Cover heatsink white for series Uni II		€ 3.55
930337	Cover heatsink black for series Uni II		€ 7.95
930339	Reflector ring black for series Uni II		€ 10.95
Accessories			
930340	Reflector ring gold for series Uni II		€ 10.95
930341	Reflector ring chrome for series Uni II		€ 10.95



page 140



page 172



page 366



Lighting design

Interested in our lighting design service?

Your contact person will be happy to answer any questions you may have.



UNI II DOUBLE













- „Glow“ effect on the reflector ring
- Rotatable and swivelling
- Can be customised with a wide range of accessories

Housing	Aluminium	Power	20 W
Colour Temperature	3000 K	Rated Input Voltage	220-240 V/AC
Luminous Flux	1350 lm	Power Supply Unit incl.	Yes
Length	212 mm	Light Beam Angle	36 Degree
Width	100 mm	Swivelling Angle	90 Degree
Height	103 mm	Control	Leading-edge dimmer, Trailing-edge dimmer
Base Length	212 mm	Colour Rendering Index (Ra)	90
Base Width	20 mm		
Base Height	14 mm		

Article	Housing Color		Price
348125	<input type="checkbox"/> White		€ 259.95
348175	<input checked="" type="checkbox"/> Black		€ 259.95



Accessories

930305	Reflector 36° for series Klara / Nihal Mini / Rigel Mini / Uni II		€ 3.6
930306	Reflector 48° for series Klara / Nihal Mini / Rigel Mini / Uni II		€ 8.95
930307	Honeycomb filter for series Klara / Nihal Mini / Rigel Mini / Uni II		€ 8.95
930308	Spread lense for series Klara / Nihal Mini / Rigel Mini / Uni II		€ 8.95
930309	Softening lense for series Klara / Nihal Mini / Rigel Mini / Uni II		€ 8.95
930310	Linear spread lense for series Klara / Nihal Mini / Rigel Mini / Uni II		€ 8.95
930334	Cover back white for series Uni II		€ 3.55
930335	Cover back black for series Uni II		€ 2.95
930336	Cover heatsink white for series Uni II		€ 3.55
930337	Cover heatsink black for series Uni II		€ 7.95
930339	Reflector ring black for series Uni II		€ 10.95
Accessories			
930340	Reflector ring gold for series Uni II		€ 10.95
930341	Reflector ring chrome for series Uni II		€ 10.95



page 140



page 172



page 366



Technical data sheet

New in the onlineshop: The technical data sheets offer even more information: Light and energy data, light distribution curves, dimensional drawings and more.



UNI II TRIPLE













- „Glow“ effect on the reflector ring
- Rotatable and swivelling
- Can be customised with a wide range of accessories

Housing	Aluminium	Power	30 W
Colour Temperature	3000 K	Rated Input Voltage	220-240 V/AC
Luminous Flux	2150 lm	Power Supply Unit incl.	Yes
Length	324 mm	Light Beam Angle	36 Degree
Width	100 mm	Swivelling Angle	90 Degree
Height	103 mm	Control	Leading-edge dimmer, Trailing-edge dimmer
Ø	100 mm	Colour Rendering Index (Ra)	90
Base Length	315 mm		
Base Width	25 mm		
Base Height	14.5 mm		

Article	Housing Color		Price
348107	<input type="checkbox"/> White		€ 369.95
348210	<input checked="" type="checkbox"/> Black		€ 369.95



Accessories

930305	Reflector 36° for series Klara / Nihal Mini / Rigel Mini / Uni II		€ 3.6
930306	Reflector 48° for series Klara / Nihal Mini / Rigel Mini / Uni II		€ 8.95
930307	Honeycomb filter for series Klara / Nihal Mini / Rigel Mini / Uni II		€ 8.95
930308	Spread lense for series Klara / Nihal Mini / Rigel Mini / Uni II		€ 8.95
930309	Softening lense for series Klara / Nihal Mini / Rigel Mini / Uni II		€ 8.95
930310	Linear spread lense for series Klara / Nihal Mini / Rigel Mini / Uni II		€ 8.95
930334	Cover back white for series Uni II		€ 3.55
930335	Cover back black for series Uni II		€ 2.95
930336	Cover heatsink white for series Uni II		€ 3.55
930337	Cover heatsink black for series Uni II		€ 7.95
930339	Reflector ring black for series Uni II		€ 10.95
930340	Reflector ring gold for series Uni II		€ 10.95
930341	Reflector ring chrome for series Uni II		€ 10.95



page 140



page 172



page 366



5-year guarantee

Benefit from the maximum quality promise:

All DEKO-LIGHT brand products come with a five-year manufacturer's guarantee.



UNI II MINI

- „Glow“ effect on the reflector ring
- Rotatable and swivelling
- Can be customised with a wide range of accessories

Housing	Aluminium	Light Beam Angle	36 Degree
Height	75 mm	Rotation Angle	350 Degree
Ø	91 mm	Swivelling Angle	90 Degree
Base Height	44 mm	Control	Leading-edge dimmer, Trailing-edge dimmer
Base Ø	75 mm	Colour Rendering Index (Ra)	90
Rated Input Voltage	220-240 V/AC		
Power Supply Unit incl.	Yes		

Article	Housing Color	Colour Temperature	Luminous Flux	Power	EEL	Price
348234	■ Black	ww 2700 K	645 lm	11.3 W		€ 129.95
348233	□ White	ww 2700 K	710 lm	11.3 W		€ 129.95
348122	□ White	ww 3000 K	600 lm	8.0 W		€ 119.95
348178	■ Black	ww 3000 K	600 lm	8.0 W		€ 119.95



Accessories

930326	Cover back white for series Uni II Mini		€ 3.55
930327	Cover back black for series Uni II Mini		€ 3.45
930328	Cover heatsink white for series Uni II Mini		€ 3.55
930329	Cover heatsink black for series Uni II Mini		€ 2.95
930330	Reflector ring white for series Uni II Mini		€ 10.95
930331	Reflector ring black for series Uni II Mini		€ 10.95
930332	Reflector ring gold for series Uni II Mini		€ 10.95
930333	Reflector ring chrome for series Uni II Mini		€ 10.95
930770	Reflector 24° for series Uni II Mini		€ 10.95
930771	Reflector 48° for series Uni II Mini		€ 10.95

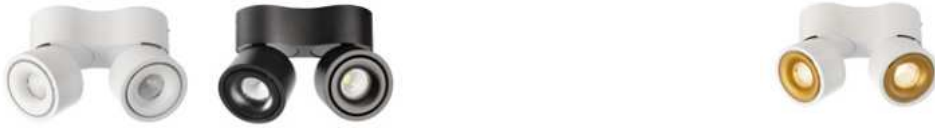

UNI II MINI DOUBLE

- „Glow“ effect on the reflector ring
- Rotatable and swivelling
- Can be customised with a wide range of accessories

Housing	Aluminium	Light Beam Angle	36 Degree
Length	160 mm	Rotation Angle	350 Degree
Width	75 mm	Swivelling Angle	90 Degree
Height	91 mm	Control	Leading-edge dimmer, Trailing-edge dimmer
Base Length	160 mm	Colour Rendering Index (Ra)	90
Base Width	75 mm		
Base Height	44 mm		
Power Supply Unit incl.	Yes		

Article	Housing Color	Colour Temperature	Luminous Flux	Power	Rated Input Voltage	EEL	Price
348236	■ Black	ww 2700 K	1240 lm	21.0 W	200-240 V/AC		€ 209.95
348235	□ White	ww 2700 K	1360 lm	21.0 W	200-240 V/AC		€ 209.95
348123	□ White	ww 3000 K	980 lm	15.0 W	220-240 V/AC		€ 199.95
348177	■ Black	ww 3000 K	980 lm	15.0 W	220-240 V/AC		€ 199.95



Accessories

930326	Cover back white for series Uni II Mini		€ 3.55
930327	Cover back black for series Uni II Mini		€ 3.45
930328	Cover heatsink white for series Uni II Mini		€ 3.55
930329	Cover heatsink black for series Uni II Mini		€ 2.95
930330	Reflector ring white for series Uni II Mini		€ 10.95
930331	Reflector ring black for series Uni II Mini		€ 10.95
930332	Reflector ring gold for series Uni II Mini		€ 10.95
930333	Reflector ring chrome for series Uni II Mini		€ 10.95
930770	Reflector 24° for series Uni II Mini		€ 10.95
930771	Reflector 48° for series Uni II Mini		€ 10.95



UNI II MAX











- High colour rendering
- Can be rotated and swivelled
- Dimmable

Housing	Aluminium	Rated Input Voltage	220-240 V/AC
Colour Temperature	3000 K	Power Supply Unit incl.	Yes
Luminous Flux	2410 lm	Light Beam Angle	36 Degree
Height	128 mm	Swivelling Angle	90 Degree
Ø	125 mm	Control	Leading-edge dimmer, Trailing-edge dimmer
Base Height	62 mm	Colour Rendering Index (Ra)	90
Base Ø	125 mm		
Power	32 W		

Article	Housing Color		Price
348127	<input type="checkbox"/> White		€ 249.95
348176	<input checked="" type="checkbox"/> Black		€ 249.95



Accessories

930390	Reflector 24° for Uni II Max		€ 10.95
930391	Reflector 36° for Uni II Max		€ 12.95
930392	Reflector 48° for Uni II Max		€ 10.95
930393	Cover back white for series Uni II Max		€ 10.95
930394	Cover back black for series Uni II Max		€ 10.95
930395	Cover heatsink white for series Uni II Max		€ 10.95
930396	Cover heatsink black for series Uni II Max		€ 10.95
930397	Reflector ring white for series Uni II Max		€ 12.95
930398	Reflector ring black for series Uni II Max		€ 10.95
930399	Reflector ring gold for series Uni II Max		€ 14.95



page 142



page 282



Onlineshop

You can find more information about the products in the onlineshop:
Detailed images, videos, project reports, LDT files, EPREL data sheets and more.



LUCEA CCT



- incl. black reflector ring
- Can be customised with a wide range of accessories
- Light colour adjustable in two stages

Housing	Aluminium	Control	Leading-edge dimmer, Trailing-edge dimmer
Colour Temperature	3000/4000 K		
Rated Input Voltage	220-240 V/AC		
Power Supply Unit incl.	Yes	Colour Rendering Index (Ra)	90
Light Beam Angle	36 Degree		

Article	Housing Color		Luminous Flux	Height	Ø	Power	Price
348153	<input type="checkbox"/> White		930/1000 lm	157 mm	65 mm	10.0 W	€ 119.95
348154	<input checked="" type="checkbox"/> Black		930/1000 lm	157 mm	65 mm	10.0 W	€ 119.95
348155	<input type="checkbox"/> White		1460/1500 lm	178 mm	85 mm	15.0 W	€ 139.95
348156	<input checked="" type="checkbox"/> Black		1460/1500 lm	178 mm	85 mm	15.0 W	€ 139.95
348157	<input type="checkbox"/> White		1930/2000 lm	178 mm	85 mm	20.0 W	€ 159.95
348158	<input checked="" type="checkbox"/> Black		1930/2000 lm	178 mm	85 mm	20.0 W	€ 159.95
348159	<input type="checkbox"/> White		2700/2900 lm	211 mm	100 mm	30.0 W	€ 179.95
348160	<input checked="" type="checkbox"/> Black		2700/2900 lm	211 mm	100 mm	30.0 W	€ 179.95



Accessories for **348153, 348154**

930679	Lense 24° for Lucea 6/10 W		€ 9.95
930756	Reflector ring for Lucea 6/10 white		€ 4.95
930757	Reflector ring for Lucea 6/10 black		€ 4.95
930758	Reflector ring for Lucea 6/10 Gold		€ 4.95

Accessories for **348155, 348156, 348157, 348158**

930680	Lense 24° for Lucea 15/20		€ 12.95
930681	Lense 60° for Lucea 15/20		€ 12.95
930759	Reflector ring for Lucea 15/20 white		€ 5.95
930760	Reflector ring for Lucea 15/20 black		€ 5.95
930761	Reflector ring for Lucea 15/20 Gold		€ 5.95

Accessories for **348159**

930677	Blind cover for Lucea 30/40 white		€ 24.95
---------------	-----------------------------------	---	---------

Accessories for **348159, 348160**

930682	Lense 24° for Lucea 30		€ 15.95
930684	Lense 60° for Lucea 30		€ 15.95
930762	Reflector ring for Lucea 30/40 white		€ 6.95
930763	Reflector ring for Lucea 30/40 black		€ 6.95
930764	Reflector ring for Lucea 30/40 Gold		€ 6.95

Accessories for **348160**

930678	Blind cover for Lucea 30/40 black		€ 24.95
---------------	-----------------------------------	---	---------



page 46



page 374



page 378



LUCEA TILT CCT

- incl. black reflector ring
- Can be customised with a wide range of accessories
- Light colour adjustable in two stages

Housing	Aluminium	Swivelling Angle	90 Degree
Colour Temperature	3000/4000 K	Control	Leading-edge dimmer, Trailing-edge dimmer
Rated Input Voltage	220-240 V/AC	Colour Rendering Index (Ra)	90
Power Supply Unit incl.	Yes		
Light Beam Angle	36 Degree		
Rotation Angle	350 Degree		

Article	Housing Color		Luminous Flux	Height	Ø	Power	Price
348161	<input type="checkbox"/> White		1000 lm	218 mm	65 mm	10.0 W	€ 129.95
348162	<input checked="" type="checkbox"/> Black		1000 lm	218 mm	65 mm	10.0 W	€ 129.95
348163	<input type="checkbox"/> White		1500 lm	241 mm	85 mm	15.0 W	€ 149.95
348164	<input checked="" type="checkbox"/> Black		1500 lm	241 mm	85 mm	15.0 W	€ 149.95
348165	<input type="checkbox"/> White		2000 lm	241 mm	85 mm	20.0 W	€ 169.95
348166	<input checked="" type="checkbox"/> Black		2000 lm	241 mm	85 mm	20.0 W	€ 169.95
348167	<input type="checkbox"/> White		2900 lm	274 mm	100 mm	30.0 W	€ 189.95
348168	<input checked="" type="checkbox"/> Black		2900 lm	274 mm	100 mm	30.0 W	€ 189.95









Accessories for **348161, 348162**

930679	Lense 24° for Lucea 6/10 W		€ 9.95
930752	Blind cover for Lucea 6/10 white		€ 22.95
930753	Blind cover for Lucea 6/10 black		€ 22.95
930756	Reflector ring for Lucea 6/10 white		€ 4.95
930757	Reflector ring for Lucea 6/10 black		€ 4.95
930758	Reflector ring for Lucea 6/10 Gold		€ 4.95

Accessories for **348163, 348164, 348165, 348166**

930680	Lense 24° for Lucea 15/20		€ 12.95
930681	Lense 60° for Lucea 15/20		€ 12.95
930754	Blind cover for Lucea 15/20 white		€ 23.95
930755	Blind cover for Lucea 15/20 black		€ 23.95
930759	Reflector ring for Lucea 15/20 white		€ 5.95
930760	Reflector ring for Lucea 15/20 black		€ 5.95
930761	Reflector ring for Lucea 15/20 Gold		€ 5.95

Accessories for **348167, 348168**

930677	Blind cover for Lucea 30/40 white		€ 24.95
930678	Blind cover for Lucea 30/40 black		€ 24.95
930682	Lense 24° for Lucea 30		€ 15.95
930684	Lense 60° for Lucea 30		€ 15.95
930762	Reflector ring for Lucea 30/40 white		€ 6.95
930763	Reflector ring for Lucea 30/40 black		€ 6.95
930764	Reflector ring for Lucea 30/40 Gold		€ 6.95



page 46



page 374



page 378



LUCEA

- incl. black reflector ring
- Can be customised with a wide range of accessories

Housing	Aluminium	Light Beam Angle	36 Degree
Colour Temperature	2700 K	Control	Leading-edge dimmer, Trailing-edge dimmer
Height	157 mm		
Ø	65 mm		
Rated Input Voltage	200-240 V/AC	Colour Rendering Index (Ra)	90
Power Supply Unit incl.	Yes		

Article	Housing Color		Luminous Flux	Power	Price
348213	<input type="checkbox"/> White		800 lm	6.0 W	€ 119.95
348214	<input checked="" type="checkbox"/> Black		800 lm	6.0 W	€ 119.95
348215	<input type="checkbox"/> White		1300 lm	10.0 W	€ 129.95
348216	<input checked="" type="checkbox"/> Black		1300 lm	10.0 W	€ 129.95



Accessories

930679	Lense 24° for Lucea 6/10 W		€ 9.95
930756	Reflector ring for Lucea 6/10 white		€ 4.95
930757	Reflector ring for Lucea 6/10 black		€ 4.95
930758	Reflector ring for Lucea 6/10 Gold		€ 4.95





LUCEA TILT

- incl. black reflector ring
- Can be customised with a wide range of accessories

Housing	Aluminium	Light Beam Angle	36 Degree
Colour Temperature	2700 K	Rotation Angle	350 Degree
Height	157 mm	Swivelling Angle	90 Degree
Ø	65 mm	Control	Leading-edge dimmer, Trailing-edge dimmer
Base Height	29 mm	Colour Rendering Index (Ra)	90
Base Ø	103.5 mm		
Rated Input Voltage	200-240 V/AC		
Power Supply Unit incl.	Yes		

Article	Housing Color		Luminous Flux	Power	Price
348223	<input type="checkbox"/> White		800 lm	6.0 W	€ 119.95
348224	<input checked="" type="checkbox"/> Black		800 lm	6.0 W	€ 119.95
348225	<input type="checkbox"/> White		1300 lm	10.0 W	€ 129.95
348226	<input checked="" type="checkbox"/> Black		1300 lm	10.0 W	€ 129.95



Accessories

930679	Lense 24° for Lucea 6/10 W		€ 9.95
930752	Blind cover for Lucea 6/10 white		€ 22.95
930753	Blind cover for Lucea 6/10 black		€ 22.95
930756	Reflector ring for Lucea 6/10 white		€ 4.95
930757	Reflector ring for Lucea 6/10 black		€ 4.95
930758	Reflector ring for Lucea 6/10 Gold		€ 4.95





LUCEA DTW

- Dim-to-warm 1,800K - 2,700K
- incl. black reflector ring
- Can be customised with a wide range of accessories

Housing	Aluminium	Power Supply Unit incl.	Yes
Colour Temperature	1800-2700 K	Light Beam Angle	36 Degree
Luminous Flux	750 lm	Control	Leading-edge dimmer, Trailing-edge dimmer
Height	157 mm	Colour Rendering Index (Ra)	90
Ø	65 mm		
Power	10 W		
Rated Input Voltage	200-240 V/AC		

Article	Housing Color		Price
348237	<input type="checkbox"/> White		€ 129.95
348238	<input checked="" type="checkbox"/> Black		€ 129.95



Accessories

930752	Blind cover for Lucea 6/10 white		€ 22.95
930753	Blind cover for Lucea 6/10 black		€ 22.95
930756	Reflector ring for Lucea 6/10 white		€ 4.95
930757	Reflector ring for Lucea 6/10 black		€ 4.95
930758	Reflector ring for Lucea 6/10 Gold		€ 4.95





LUCEA DTW TILT

- Dim-to-warm 1,800K - 2,700K
- incl. black reflector ring
- Can be customised with a wide range of accessories

Housing	Aluminium	Light Beam Angle	36 Degree
Colour Temperature	1800-2700 K	Rotation Angle	350 Degree
Luminous Flux	750 lm	Swivelling Angle	90 Degree
Height	218 mm	Control	Leading-edge dimmer, Trailing-edge dimmer
Ø	65 mm	Colour Rendering Index (Ra)	90
Power	10 W		
Rated Input Voltage	200-240 V/AC		
Power Supply Unit incl.	Yes		

Article	Housing Color		Price
348239	<input type="checkbox"/> White		€ 129.95
348240	<input checked="" type="checkbox"/> Black		€ 129.95



Accessories

930752	Blind cover for Lucea 6/10 white		€ 22.95
930753	Blind cover for Lucea 6/10 black		€ 22.95
930756	Reflector ring for Lucea 6/10 white		€ 4.95
930757	Reflector ring for Lucea 6/10 black		€ 4.95
930758	Reflector ring for Lucea 6/10 Gold		€ 4.95





CAN IP20

The new CAN series is an all-round solution for both private and commercial use. Available as a pendant light, ceiling light, wall light, reading light and outdoor light, the CAN feels at home in living rooms, hotel rooms, restaurants and many other environments. All versions have the GU10 socket in common, which allows flexible choice and easy replacement of the light source.



page 51



page 180



page 194



page 195



page 364



page 439



CAN IP20

- customised lighting solution thanks to replaceable light source
- can be combined with the product family of the CAN series

Housing	Aluminium	Rated Input Voltage	220-240 V/AC
Height	105 mm	Control	Dimmable via optional light source
Ø	60 mm		
Max. Power	1x max. 7.5 W		

Article	Housing Color	Price
348241	<input type="checkbox"/> White	€ 29.95
348242	<input checked="" type="checkbox"/> Black	€ 29.95



CAN IP44

- Customised lighting solution thanks to replaceable light source
- Can be combined with the extensive product family of the CAN series
- Suitable for damp rooms

Housing	Aluminium	Rated Input Voltage	220-240 V/AC
Height	105 mm	Control	Dimmable via optional light source
Ø	60 mm		
Max. Power	1x max. 7.5 W		

Article	Housing Color	Price
348243	<input type="checkbox"/> White	€ 34.95
348244	<input checked="" type="checkbox"/> Black	€ 34.95





CAN TILT ANGULAR

- customised lighting solution thanks to replaceable light source
- can be combined with the product family of the CAN series

Housing	Aluminium	Rated Input Voltage	220-240 V/AC
Height	125 mm	Control	Dimmable via optional light source
Ø	60 mm	Rotation Angle	350 Degree
Base Width	90 mm	Swivelling Angle	90 Degree
Base Height	15 mm		

Article	Housing Color	Base Length	Max. Power	Price
348245	<input type="checkbox"/> White	110 mm	1x max. 7.5 W	€ 44.95
348246	<input checked="" type="checkbox"/> Black	110 mm	1x max. 7.5 W	€ 44.95
348247	<input type="checkbox"/> White	305 mm	2x max. 7.5 W	€ 84.95
348248	<input checked="" type="checkbox"/> Black	305 mm	2x max. 7.5 W	€ 84.95
348249	<input type="checkbox"/> White	480 mm	3x max. 7.5 W	€ 119.95
348250	<input checked="" type="checkbox"/> Black	480 mm	3x max. 7.5 W	€ 119.95

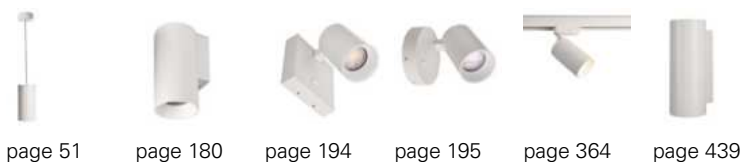



CANTILT ROUND

- customised lighting solution thanks to replaceable light source
- can be combined with the product family of the CAN series

Housing	Aluminium	Control	Dimmable via optional light source
Height	125 mm	Rotation Angle	350 Degree
Ø	60 mm	Swivelling Angle	90 Degree
Base Height	15 mm		
Rated Input Voltage	220-240 V/AC		

Article	Housing Color	Base Ø	Max. Power	Price
348251	<input type="checkbox"/> White	80 mm	1x max. 7.5 W	€ 44.95
348252	<input checked="" type="checkbox"/> Black	80 mm	1x max. 7.5 W	€ 44.95
348253	<input type="checkbox"/> White	200 mm	2x max. 7.5 W	€ 84.95
348254	<input checked="" type="checkbox"/> Black	200 mm	2x max. 7.5 W	€ 84.95
348255	<input type="checkbox"/> White	250 mm	3x max. 7.5 W	€ 119.95
348256	<input checked="" type="checkbox"/> Black	250 mm	3x max. 7.5 W	€ 119.95





BENGALA

- replaceable lamp (GU10)
- can be rotated and swivelled

Housing	Aluminium	Rated Input Voltage	220-240 V/AC
Height	120 mm	Control	Dimmable via optional light source
Ø	96 mm	Swivelling Angle	30 Degree
Base Ø	96 mm		
Max. Power	1x max. 50 W		

Article	Housing Color	Price
122416	Silver	€ 44.95
348022	Black	€ 44.95
348023	White	€ 44.95



DATO

- replaceable lamp (GU10)
- can be rotated and swivelled

Housing	Aluminium	Max. Power	1x max. 50 W
Length	96 mm	Rated Input Voltage	220-240 V/AC
Width	96 mm	Control	Dimmable via optional light source
Height	120 mm	Swivelling Angle	30 Degree
Base Length	96 mm		
Base Width	96 mm		

Article	Housing Color	Price
122417	Silver	€ 44.95
348024	Black	€ 44.95
348025	White	€ 44.95

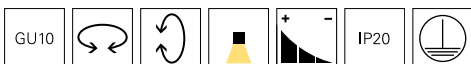



MONA

- replaceable lamp (GU10)
- can be rotated and swivelled

Housing	Aluminium	Control	Dimmable via optional light source
Width	93 mm	Swivelling Angle	45 Degree
Height	120 mm		
Rated Input Voltage	220-240 V/AC		

Article	Housing Color	Length	Max. Power	Price
348001	<input type="checkbox"/> White	93 mm	1x max. 50.0 W	€ 59.95
348002	<input checked="" type="checkbox"/> Black	93 mm	1x max. 50.0 W	€ 59.95
348004	<input type="checkbox"/> White	186 mm	2x max. 50.0 W	€ 109.95
348005	<input checked="" type="checkbox"/> Black	186 mm	2x max. 50.0 W	€ 109.95





MADERA

The MADERA series is made from premium European oak and captivates with its modern design and mix of materials in private living areas, hotels, restaurants and many more places too.

The elegant MADERA lights distribute their powerful warm white light in every room and also cut an excellent figure providing functional and high-quality lighting at reception desks and elsewhere.



page 64



page 152



page 172



page 173



MADERA

- Manufactured in Europe from high-quality class A oak
- FSC-certified oak raw material from sustainable forestry

Housing	Wood, Steel	Base Height	30 mm
Colour Temperature	3000 K	Power	15 W
Luminous Flux	1120 lm	Rated Input Voltage	100-240 V/AC
Length	810 mm	Power Supply Unit incl.	Yes
Width	135 mm	Light Beam Angle	120 Degree
Height	115 mm	Colour Rendering Index (Ra)	80
Base Length	250 mm		
Base Width	135 mm		

Article	Housing Color		Price
348147	Brown, Black		€ 499.95

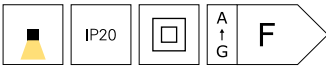

MADERA DIM

- manufactured in Europe from high-quality class A oak
- FSC-certified oak raw material from sustainable forestry
- incl. indirect lighting upwards

Housing	Wood, Steel	Base Height	30 mm
Colour Temperature	3000 K	Power	22 W
Luminous Flux	2740 lm	Rated Input Voltage	100-240 V/AC
Length	1100 mm	Power Supply Unit incl.	Yes
Width	42 mm	Control	Leading-edge dimmer
Height	60 mm	Colour Rendering Index (Ra)	85
Base Length	250 mm		
Base Width	135 mm		

Article	Housing Color		Price
348212	Brown, Black		€ 569.95





DRACONIS

The DRACONIS series from DEKO-LIGHT allows flexible ceiling lighting for a variety of applications in the areas of industry, trade and logistics. With the DRACONIS light for optional use as a surface-mounted ceiling light or in a 3-phase track system, the power [45, 55 or 72 W] and light colour [2,700, 3,500 or 4,000 K] can be flexibly adjusted using a switch on the back of the housing. To be able to integrate the DRACONIS into almost any environment, we offer several lenses for asymmetrical or symmetrical lighting in different light emission angles. The maximum luminous flux is 8,215 lumens.



luminous flux at 2700 K: 72 W = 7330 lm / 55 W = 6000 lm / 45 W = 5030 lm
 luminous flux at 3500 K: 72 W = 8210 lm / 55 W = 6590 lm / 45 W = 5560 lm
 luminous flux at 4000 K: 72 W = 8250 lm / 55 W = 6950 lm / 45 W = 5700 lm





DRACONIS

- Output adjustable in three stages
- Light colour adjustable in three stages
- High luminous flux
- Interchangeable lenses

Housing	Aluminium	Base Height	25 mm
Colour Temperature	2700/3500/4000 K	Power Selectable	45 W, 55 W, 72 W
Luminous Flux	8215 lm	Rated Input Voltage	220-240 V/AC
Length	577.6 mm	Power Supply Unit incl.	Yes
Width	188.6 mm	Light Beam Angle	60 Degree
Height	71 mm	Colour Rendering Index (Ra)	80
Base Length	102 mm		
Base Width	88 mm		

Article	Housing Color		Price
348099	<input type="checkbox"/> Aluminum		€ 269.95
348128	<input type="checkbox"/> White		€ 269.95



Accessories

930544	20° Lens for surface-mounted ceiling light Draconis symmetrical		€ 9.95
930545	30° Lens for surface-mounted ceiling light Draconis symmetrical		€ 9.95
930546	90° Lens for surface-mounted ceiling light Draconis symmetrical		€ 9.95
930577	15° Lens for surface-mounted ceiling light Draconis asymmetrical		€ 9.95

built in ceiling lights



□ □ □ □
□ □
page 100



■ □ □ □
□ □
page 101



□ □ □ □
■ □
page 102



□ □ □ □
■ □
page 103



□ □ □
page 104



□ □ □
page 104



□
page 105



□
page 105



□ □ □ □
□ □
page 108



□ ■
page 112



□
page 114



□
page 115



page 116



page 117



page 118



page 119



page 124



page 126



page 128



page 130



page 132



page 135



page 136



page 138



page 140



page 144



BUILT-IN CEILING LAMP GU10 BASIC

Housing	Metal	Rated Input Voltage	220-240 V/AC
Height	140 mm	Cut Out Ø	68 mm
Ø	89 mm	Control	Dimmable via optional light source
Installation Depth	140 mm	Swivelling Angle	30 Degree
Max. Power	1x max. 35 W		

Article	Housing Color	Surface	Price
110032	<input type="checkbox"/> White	Matt	€ 16.95
110033	<input type="checkbox"/> Chrome	Shiny	€ 16.95
110034	<input type="checkbox"/> Silver	Brushed	€ 16.95
110035	<input type="checkbox"/> Aluminum	Matt	€ 16.95
110036	<input type="checkbox"/> Copper	Shiny	€ 16.95
110037	<input type="checkbox"/> Black	Matt	€ 16.95



Accessories

829063 Safety spacer



€ 5.95



Light sources

For all lights and bases:

You can find the right light sources in the »Light sources« section.



BUILT IN CEILING LAMP MR16 BASIC

Housing	Metal	Cut Out Ø	68 mm
Ø	89 mm	Control	Dimmable via optional light source
Installation Depth	65 mm	Swivelling Angle	30 Degree
Max. Power	1x max. 50 W		
Rated Input Voltage	12 V/AC/DC		

Article	Housing Color	Surface	Price
686864	■ Black	Matt	€ 10.95
686867	■ Copper	Shiny	€ 10.95
686868	□ White	Matt	€ 10.95
686869	■ Chrome	Shiny	€ 10.95
686871	■ Silver	Brushed	€ 10.95
686880	□ Aluminum	Matt	€ 10.95



MODULA ROUND

Housing	Aluminium	Rated Input Voltage	12 V/AC/DC
Surface	Matt	Cut Out Ø	80 mm
Height	26 mm	Control	Dimmable via optional light source
Ø	92 mm	Swivelling Angle	35 Degree
Installation Depth	75 mm		
Max. Power	1x max. 35 W		

Article	Housing Color	Price
110222	■ Silver	€ 17.95



Accessories

829063 Safety spacer



€ 5.95



SAMSOLA ROUND



- Suitable for GU10/GU5.3 holders (sold separately)
- Lamps are simple to install by means of a click lock

Housing	Metal	Control	Dimmable via optional light source
Height	23 mm		
Ø	82 mm	Swivelling Angle	30 Degree
Cut Out Ø	68 mm		

Article	Housing Color	Surface	Price
110038	 Copper	Brushed	€ 9.95
110039	 White	Matt	€ 9.95
110040	 Silver	Brushed	€ 9.95
110041	 Silver	Shiny	€ 9.95
110042	 Aluminium	Matt	€ 9.95
110043	 Black	Matt	€ 9.95



Accessories

100204	Socket GU10 with spacer		€ 3.95
100200	Socket GU5.3 with 15 cm cable		€ 0.95
829063	Safety spacer		€ 5.95



Light sources

For all lights and bases:
You can find the right light sources in the »Light sources« section.

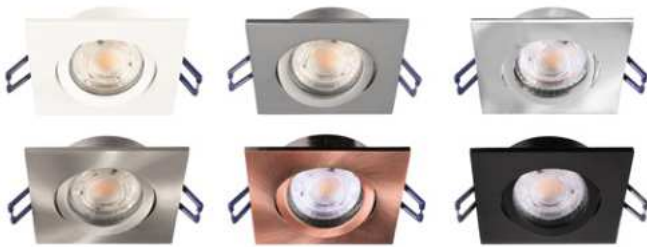

SAMSOLA ANGULAR

- Suitable for GU10/GU5.3 holders (sold separately)
- Lamps are simple to install by means of a click lock

Housing	Metal	Cut Out Ø	68 mm
Length	85 mm	Control	Dimmable via optional light source
Width	85 mm	Swivelling Angle	30 Degree
Height	23 mm		

Article	Housing Color	Surface	Price
110044	Copper	Brushed	€ 9.95
110045	White	Matt	€ 9.95
110046	Silver	Brushed	€ 9.95
110047	Silver	Shiny	€ 9.95
110048	Aluminium	Matt	€ 9.95
110049	Black	Matt	€ 9.95



Accessories

100204	Socket GU10 with spacer		€ 3.95
100200	Socket GU5.3 with 15 cm cable		€ 0.95
829063	Safety spacer		€ 5.95



Light sources

For all lights and bases:
You can find the right light sources in the »Light sources« section.



BUILT IN CEILING LAMP STYLE ROUND

Housing	Aluminium	Rated Input Voltage	12 V/AC/DC
Height	27 mm	Cut Out Ø	68 mm
Ø	81 mm	Control	Dimmable via optional light source
Installation Depth	65 mm	Swivelling Angle	30 Degree
Max. Power	1x max. 35 W		

Article	Housing Color	Surface	Price
449200	<input type="checkbox"/> White	Matt	€ 12.95
449201	<input type="checkbox"/> Chrome	Shiny	€ 12.95
449202	<input type="checkbox"/> Silver	Brushed	€ 12.95



BUILT IN CEILING LAMP STYLE ROUND

Housing	Aluminium	Rated Input Voltage	12 V/AC/DC
Length	82 mm	Cut Out Ø	68 mm
Width	82 mm	Control	Dimmable via optional light source
Height	27 mm	Swivelling Angle	30 Degree
Installation Depth	65 mm		
Max. Power	1x max. 35 W		

Article	Housing Color	Surface	Price
449210	<input type="checkbox"/> White	Matt	€ 12.95
449211	<input type="checkbox"/> Chrome	Shiny	€ 12.95
449212	<input type="checkbox"/> Silver	Brushed	€ 12.95



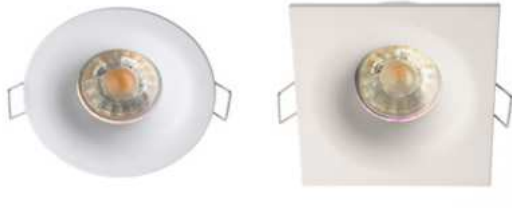

ALTAIR

- Exchangeable lamp (GU5.3/MR16)
- Dimmable

Housing	Aluminium	Rated Input Voltage	12 V/AC/DC
Height	35 mm	Cut Out Ø	68 mm
Installation Depth	33 mm	Control	Dimmable via optional light source
Max. Power	1x max. 35 W		

Article	Housing Color	Length	Width	Ø	Price
110017	<input type="checkbox"/> White			85 mm	€ 11.95
110018	<input type="checkbox"/> White	85 mm	85 mm		€ 11.95



ARKTUR

- Exchangeable lamp (GU5.3/MR16)
- Swivel-mounted
- Dimmable

Housing	Aluminium	Control	Dimmable via optional light source
Height	43 mm	Swivelling Angle	30 Degree
Max. Power	1x max. 35 W		
Rated Input Voltage	12 V/AC/DC		

Article	Housing Color	Length	Width	Ø	Cut Out Length	Cut Out Width	Price
110019	<input type="checkbox"/> White			93 mm			€ 15.95
110020	<input type="checkbox"/> White	90 mm	90 mm		80 mm	80 mm	€ 15.95



DIONE

The new DIONE series comprises elegant recessed spotlights in aluminium housing with particularly shallow mounting depth - a real problem solver in the refurbishment sector.

The popular DIONE recessed ceiling luminaires with high-quality COB LED including reflector are housed in an aluminium casing and have a cut-out dimension of 68 mm. While the available colours white, silver, black, chrome and nickel harmonise with almost any type of ceiling, the actual special feature of the DIONE is not visible when installed: The recessed spotlights are extremely space-saving when installed and require only 25 or 27 mm of ceiling cavity. This is where the power supply unit and the Quick connection box are located, which allows 3-pole through-wiring of several DIONE models as well as retrofitting as part of renovations.

The plug-in connector between the spotlight and the power supply unit allows installers to conveniently install the lighting equipment and connect the spotlight once the ceiling work has been completed.

The DIONE recessed spotlights are available in the light colours 2,700 K, 3,000 K, 4,000 K and as a dim-to-warm version [1,800 - 3,000 K]. In addition to the IP20 version, an IP44 version is also available, making the DIONE suitable for bathrooms and other damp areas indoors.

With this variety, the DIONE series offers recessed spotlights for a wide range of applications - from private homes and exhibition areas to guest areas in hotels and restaurants. Thanks to the wide selection of light colours and IP classes, the DIONE can be flexibly integrated into any environment and covers all design requirements, from a feel-good character to functional lighting.



only 25 or 27 mm ceiling cavity required

H x Ø: 41 x 82 mm [cut-out dimension 68 mm]

aluminium housing in white, silver, black, chrome and brushed nickel

reflector with 36° beam angle

high-quality COB technology with up to 800 lm

new connector between spot and power supply unit for even more convenient mounting

dimnable power supply unit

Quick connection box with quick-release fastener [optionally fixable with screw] for quick installation and through-wiring for flexible and rigid cables up to 1.5 mm² NYM



Living space

- living and dining room
- children's room
- study room
- kitchen
- hallway and staircase



Business Areas

- hotel
- gastronomy
- trade fair
- shop fitting



Damp room

- bathroom
- laundry room
- wellness centre
- indoor swimming pool



DIONE IP20



- Flat installation depth
- Incl. dimmable power supply unit and connection box
- Feed-through wiring possible
- Ideal refurbishment solution
- Light and power supply unit with adapter plug

Housing	Aluminium	Required Installation	25 mm
Height	41 mm	Depth	
Ø	82 mm	Light Beam Angle	36 Degree
Power	8.5 W	Swivelling Angle	30 Degree
Rated Input Voltage	220-240 V/AC	Cut Out Ø	68 mm
Power Supply Unit incl.	Yes	Control	Leading-edge dimmer, Trailing-edge dimmer
Installation Depth	38 mm		

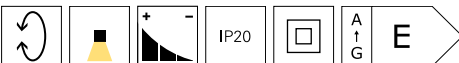
Article	Housing Color	Colour Temperature	Luminous Flux	Colour Rendering Index (Ra)	Price
565375	<input type="checkbox"/> White	2700 K	750 lm	81	€ 59.95
565376	<input type="checkbox"/> Silver	2700 K	750 lm	81	€ 59.95
565377	<input checked="" type="checkbox"/> Black	2700 K	750 lm	81	€ 59.95
565378	<input type="checkbox"/> Nickel	2700 K	750 lm	81	€ 59.95
565379	<input type="checkbox"/> Chrome	2700 K	750 lm	81	€ 59.95
565355	<input type="checkbox"/> White	3000 K	800 lm	81	€ 59.95
565356	<input type="checkbox"/> Silver grey	3000 K	800 lm	81	€ 59.95
565357	<input checked="" type="checkbox"/> Black	3000 K	800 lm	81	€ 59.95
565371	<input type="checkbox"/> Nickel	3000 K	800 lm	81	€ 59.95
565372	<input type="checkbox"/> Chrome	3000 K	800 lm	81	€ 59.95
565358	<input type="checkbox"/> White	4000 K	800 lm	84	€ 59.95
565359	<input type="checkbox"/> Silver grey	4000 K	800 lm	84	€ 59.95
565360	<input checked="" type="checkbox"/> Black	4000 K	800 lm	84	€ 59.95
565373	<input type="checkbox"/> Nickel	4000 K	800 lm	84	€ 59.95
565374	<input type="checkbox"/> Chrome	4000 K	800 lm	84	€ 59.95



Accessories

- 930863** Reflector 60° for Dione light series  € 5.95
- 930864** Frosted diffusing lens for Dione lamp series  € 2.95
- 829063** Safety spacer  € 5.95



DIONE IP20 DTW



- Flat installation depth (25 mm)
- Incl. dimmable power supply unit and connection box
- Feed-through wiring possible
- Ideal refurbishment solution
- Light and power supply unit with adapter plug

Housing	Aluminium	Required Installation	25 mm
Colour Temperature	1800-3000 K	Depth	
Luminous Flux	480 lm	Light Beam Angle	36 Degree
Height	41 mm	Swivelling Angle	30 Degree
Ø	82 mm	Cut Out Ø	68 mm
Power	8.5 W	Control	Leading-edge dimmer, Trailing-edge dimmer
Rated Input Voltage	220-240 V/AC	Colour Rendering Index (Ra)	95
Power Supply Unit incl.	Yes		
Installation Depth	38 mm		

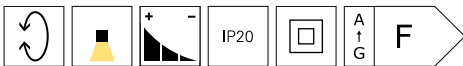
Article	Housing Color		Price
565380	<input type="checkbox"/> White	ww	€ 69.95
565381	<input type="checkbox"/> Silver	ww	€ 69.95
565382	<input type="checkbox"/> Black	ww	€ 69.95
565383	<input type="checkbox"/> Chrome	ww	€ 69.95
565384	<input type="checkbox"/> Nickel	ww	€ 69.95



Accessories

930863	Reflector 60° for Dione light series		€ 5.95
930864	Frosted diffusing lens for Dione lamp series		€ 2.95
829063	Safety spacer		€ 5.95

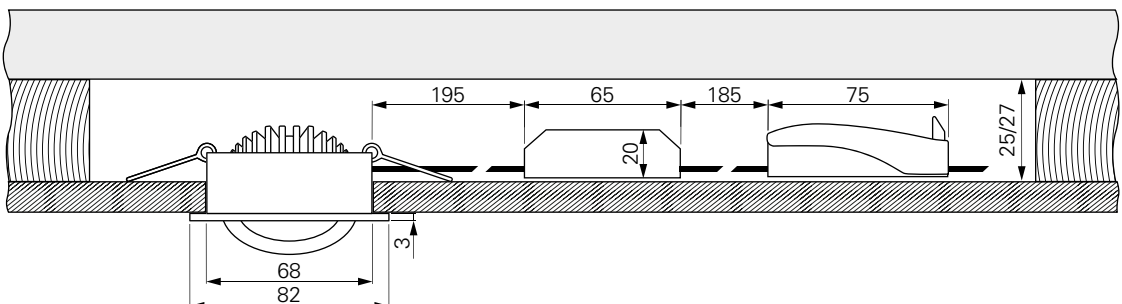



DIONE IP44

- Flat installation depth
- Splash-proof (downwards after installation)
- Including dimmable power supply and connection box
- Feed-through wiring possible
- Ideal refurbishment solution
- Light and power supply unit with adapter plug

Housing	Aluminium	Required Installation Depth	27 mm
Height	41 mm	Light Beam Angle	36 Degree
Ø	82 mm	Swivelling Angle	30 Degree
Power	8.5 W	Cut Out Ø	68 mm
Rated Input Voltage	220-240 V/AC	Control	Leading-edge dimmer, Trailing-edge dimmer
Power Supply Unit incl.	Yes		
Installation Depth	41 mm		

Article	Housing Color	Colour Temperature	Luminous Flux	Colour Rendering Index (Ra)	Price
565388	White	2700 K	750 lm	81	€ 64.95
565389	Silver	2700 K	750 lm	81	€ 64.95
565390	Black	2700 K	750 lm	81	€ 64.95
565391	Chrome	2700 K	750 lm	81	€ 64.95
565392	Nickel	2700 K	750 lm	81	€ 64.95
565393	White	3000 K	800 lm	81	€ 64.95
565394	Silver	3000 K	800 lm	81	€ 64.95
565395	Black	3000 K	800 lm	81	€ 64.95
565396	Chrome	3000 K	800 lm	81	€ 64.95
565397	Nickel	3000 K	800 lm	81	€ 64.95
565398	White	4000 K	800 lm	84	€ 64.95
565399	Silver	4000 K	800 lm	84	€ 64.95
565400	Black	4000 K	800 lm	84	€ 64.95
565401	Chrome	4000 K	800 lm	84	€ 64.95
565402	Nickel	4000 K	800 lm	84	€ 64.95

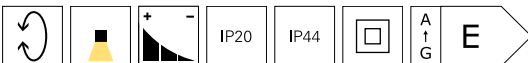

Accessories

930863	Reflector 60° for Dione light series		€ 5.95
930864	Frosted diffusing lens for Dione lamp series		€ 2.95
829063	Safety spacer		€ 5.95



DIONE IP44 DTW



- Flat installation depth
- Splash-proof (downwards after installation)
- Including dimmable power supply and connection box
- Feed-through wiring possible
- Ideal refurbishment solution
- Light and power unit with adapter plug

Housing	Aluminium	Required Installation Depth	27 mm
Colour Temperature	1800-3000 K	Light Beam Angle	36 Degree
Luminous Flux	480 lm	Swivelling Angle	30 Degree
Height	41 mm	Cut Out Ø	68 mm
Ø	82 mm	Control	Leading-edge dimmer, Trailing-edge dimmer
Power	8.5 W	Colour Rendering Index (Ra)	95
Rated Input Voltage	220-240 V/AC		
Power Supply Unit incl.	Yes		
Installation Depth	41 mm		

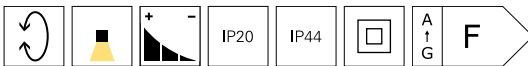
Article	Housing Color		Price
565403	<input type="checkbox"/> White	ww	€ 74.95
565404	<input type="checkbox"/> Silver	ww	€ 74.95
565405	<input type="checkbox"/> Black	ww	€ 74.95
565406	<input type="checkbox"/> Chrome	ww	€ 74.95
565407	<input type="checkbox"/> Nickel	ww	€ 74.95



Accessories

930863	Reflector 60° for Dione light series		€ 5.95
930864	Frosted diffusing lens for Dione lamp series		€ 2.95
829063	Safety spacer		€ 5.95

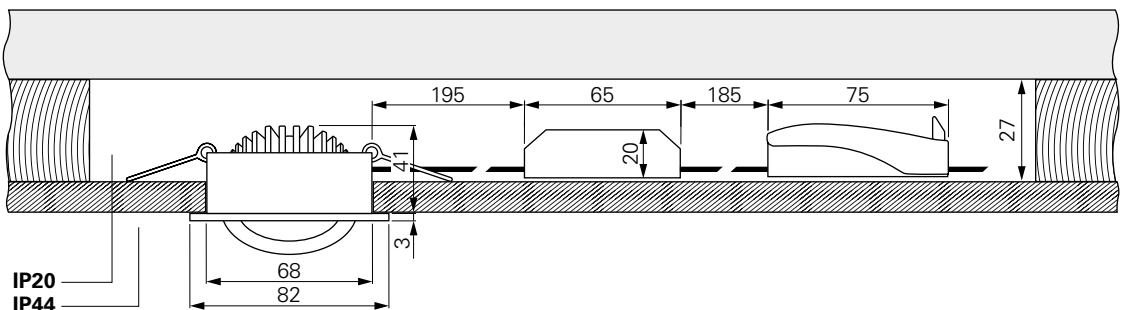



SMD-68-230V-ROUND

Plenty of power for less! SMD-68 series recessed lights deliver up to 550 lm and also have an integrated, dimmable power supply (230 V direct connection), which makes the use of GU10 holders and retrofitted equipment redundant.



SMD-68-230V-ROUND

- Integrated power supply unit
- swivelling
- low installation depth

Housing	Plastic	Light Beam Angle	45 Degree
Height	43.8 mm	Swivelling Angle	36 Degree
Ø	85 mm	Cut Out Ø	68 mm
Power	6.5 W	Control	Leading-edge dimmer, Trailing-edge dimmer
Rated Input Voltage	220-240 V/AC	Colour Rendering Index (Ra)	80
Power Supply Unit incl.	Yes		
Installation Depth	41.3 mm		

Article	Housing Color	Colour Temperature	Luminous Flux	EEL	Price
565337	<input type="checkbox"/> White	2700 K	510 lm		€ 19.95
565385	<input checked="" type="checkbox"/> Black	2700 K	510 lm		€ 19.95
565338	<input type="checkbox"/> White	3000 K	540 lm		€ 19.95
565386	<input checked="" type="checkbox"/> Black	3000 K	540 lm		€ 19.95
565339	<input type="checkbox"/> White	4000 K	550 lm		€ 19.95
565387	<input checked="" type="checkbox"/> Black	4000 K	550 lm		€ 19.95



Technical data sheet

New in the onlineshop: The technical data sheets offer even more information: Light and energy data, light distribution curves, dimensional drawings and more.



COB 68 IP65



- Ideal for damp rooms
- Can be individually combined with power supply unit [excl.]

Housing	Aluminium	Light Beam Angle	45 Degree
Height	44 mm	Cut Out Ø	68 mm
Ø	78 mm	Control	Dimmable via optional power supply unit
Power	6.5 W	Colour Rendering Index (Ra)	80
Rated Input Voltage	17-18 V/DC	Rated Current	350 mA
Power Supply Unit incl.	No		
Installation Depth	46 mm		

Article	Housing Color	Colour Temperature	Luminous Flux	Price
565108	<input type="checkbox"/> White	ww 2700 K	670 lm	€ 59.95
565110	<input type="checkbox"/> White	nw 4000 K	730 lm	€ 59.95



Accessories

829063	Safety spacer		€ 5.95
180512	BASIC, CC, CC35018/18W		€ 23.95
862202	BASIC, DIM, CC, D35009UF/9W		€ 28.95



COB 68 HCL

- Suitable for 24 V HCL control units
- swivelling

Housing	Aluminium	Installation Depth	60 mm
Colour Temperature	2500-6500 K	Light Beam Angle	65 Degree
Luminous Flux	534 lm	Swivelling Angle	25 Degree
Height	46 mm	Cut Out Ø	68 mm
Ø	78 mm	Control	Dimmable via optional controller
Power	8 W	Colour Rendering Index (Ra)	80
Rated Input Voltage	24 V/DC		
Power Supply Unit incl.	No		

Article	Housing Color	Colour Temperature	Price
565193	<input type="checkbox"/> White	ww cw 2500-6500 K	€ 64.95

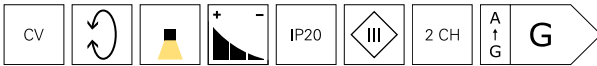

COB 95 HCL

Housing	Aluminium	Installation Depth	70 mm
Colour Temperature	2500-6500 K	Light Beam Angle	65 Degree
Luminous Flux	1118 lm	Swivelling Angle	25 Degree
Height	65 mm	Cut Out Ø	95 mm
Ø	108 mm	Control	Dimmable via optional controller
Power	16 W	Colour Rendering Index (Ra)	80
Rated Input Voltage	24 V/DC		
Power Supply Unit incl.	No		

Article	Housing Color	Colour Temperature	Price
565194	<input type="checkbox"/> White	ww cw 2500-6500 K	€ 109.95

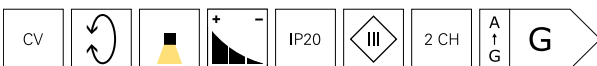



COB 68 ACRYL

- Acrylic glass ring
- Discreet side lighting

Housing	Aluminium	Installation Depth	50 mm
Colour Temperature	2700 K	Light Beam Angle	30 Degree
Luminous Flux	675 lm	Cut Out Ø	62 mm
Length	78 mm	Control	Dimmable via optional power supply unit
Height	53.5 mm	Colour Rendering Index (Ra)	80
Ø	78 mm	Rated Current	350 mA
Power	6.5 W		
Rated Input Voltage	18-20 V/DC		
Power Supply Unit incl.	No		

Article	Housing Color		Price
565195	Silver		€ 65.95

CC

IP20

1 CH

A
↑
G

G



COB 68 ACRYLIC HCL

Housing	Aluminium	Installation Depth	43 mm
Colour Temperature	2400-6500 K	Light Beam Angle	45 Degree
Luminous Flux	590 lm	Cut Out Ø	68 mm
Height	58.5 mm	Control	Dimmable via optional controller
Ø	78 mm	Colour Rendering Index (Ra)	80
Power	8 W		
Rated Input Voltage	24 V/DC		
Power Supply Unit incl.	No		

Article	Housing Color	Colour Temperature	Price
565247	Silver	2400-6500 K	€ 65.95

CV

IP20

A
↑
G

E



COB 68 RGBW

- Suitable for 24 V colour controls
- swivelling

Housing	Aluminium	Installation Depth	55 mm
Colour Temperature	3000 K	Light Beam Angle	50 Degree
Luminous Flux	500 lm	Swivelling Angle	25 Degree
Height	48 mm	Cut Out Ø	68 mm
Ø	78 mm	Control	Dimmable via optional controller
Power	8.5 W	Colour Rendering Index (Ra)	80
Rated Input Voltage	24 V/DC		
Power Supply Unit incl.	No		

Article	Housing Color		Price
565335	<input type="checkbox"/> White		€ 99.95
565336	<input type="checkbox"/> Silver		€ 99.95

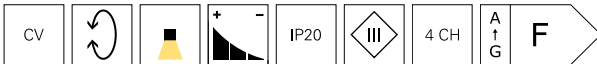

COB-68-350MA-2700K-SQUARE

Housing	Aluminium	Light Beam Angle	45 Degree
Length	78 mm	Swivelling Angle	25 Degree
Width	78 mm	Cut Out Ø	68 mm
Height	46 mm	Control	Dimmable via optional power supply unit
Power	6 W	Colour Rendering Index (Ra)	90
Rated Input Voltage	16-17 V/DC	Rated Current	350 mA
Power Supply Unit incl.	No		
Installation Depth	50 mm		

Article	Housing Color	Colour Temperature	Luminous Flux	EEL	Price
565282	<input type="checkbox"/> Silver	2700 K	580 lm		€ 59.95
565283	<input type="checkbox"/> White	2700 K	580 lm		€ 59.95
565284	<input type="checkbox"/> Silver	4000 K	660 lm		€ 59.95
565285	<input type="checkbox"/> White	4000 K	660 lm		€ 59.95





COB 95 RGBW

- Suitable for 24 V colour control
- swivelling

Housing	Aluminium	Installation Depth	68 mm
Colour Temperature	3000 K	Light Beam Angle	60 Degree
Luminous Flux	710 lm	Swivelling Angle	25 Degree
Height	70 mm	Cut Out Ø	95 mm
Ø	110 mm	Control	Dimmable via optional controller
Power	16 W	Colour Rendering Index (Ra)	80
Rated Input Voltage	24 V/DC		
Power Supply Unit incl.	No		

Article	Housing Color		Price
565245	<input type="checkbox"/> White	RGB WW	€ 129.95
565246	<input type="checkbox"/> Silver	RGB WW	€ 129.95

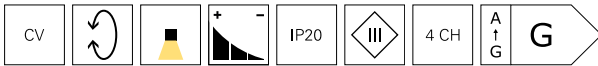

Accessories

829063	Safety spacer		€ 5.95
862234	FLAT, CV, UT24V/20W		€ 25.95
862166	BASIC, CV, Q8H-24-100W		€ 96.95
843502	RF-smart, Starter-Set RGBW/CCT, 12-48V, 20A remote control, IP20 incl.		€ 99.95



COB 95 MAX

- Plug on the luminaire housing
- incl. two diffuser discs [clear, satinised]

Housing	Aluminium	Light Beam Angle	60 Degree
Luminous Flux	1100 lm	Cut Out Ø	95 mm
Height	53 mm	Control	Dimmable via optional power supply unit
Ø	110 mm	Colour Rendering Index (Ra)	90
Power	13 W	Rated Current	350 mA
Rated Input Voltage	34.8 V/DC		
Power Supply Unit incl.	No		
Installation Depth	53 mm		

Article	Housing Color	Colour Temperature	EEL	Price
565007	<input type="checkbox"/> White	3000 K		€ 89.95
565010	<input type="checkbox"/> White	4000 K		€ 89.95



Accessories

180512	BASIC, CC, CC35018/18W		€ 23.95
862204	BASIC, DIM, CC, D35020UF/20W		€ 39.95
862191	BASIC, DIM, Multi CC, IE-25D		€ 64.95



COB 130 MAX

- Plug on the luminaire housing
- incl. two diffuser discs [clear, satinised]

Housing	Aluminium	Light Beam Angle	60 Degree
Height	69 mm	Cut Out Ø	130 mm
Ø	145 mm	Control	Dimmable via optional power supply unit
Power	18.5 W	Colour Rendering Index (Ra)	90
Rated Input Voltage	34.8 V/DC	Rated Current	500 mA
Power Supply Unit incl.	No		
Installation Depth	69 mm		

Article	Housing Color	Colour Temperature	Luminous Flux	Price
565180	<input type="checkbox"/> White	3000 K	1360 lm	€ 119.95
565181	<input type="checkbox"/> White	4000 K	1451 lm	€ 119.95

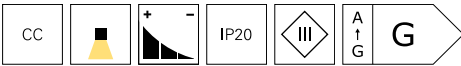

Accessories

862226	FLAT, CC, UT500mA/20W		€ 28.95
862205	BASIC, DIM, CC, D50020UF/20W		€ 39.95
862191	BASIC, DIM, Multi CC, IE-25D		€ 64.95

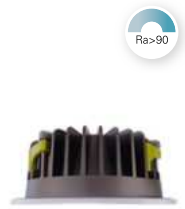

COB 170 MAX

- Plug on the luminaire housing
- incl. two diffuser discs [clear, satinised]

Housing	Aluminium	Light Beam Angle	60 Degree
Luminous Flux	2100 lm	Cut Out Ø	170 mm
Height	86 mm	Control	Dimmable via optional power supply unit
Ø	190 mm	Colour Rendering Index (Ra)	90
Rated Input Voltage	35 V/DC	Rated Current	700 mA
Power Supply Unit incl.	No		
Installation Depth	86 mm		

Article	Housing Color	Colour Temperature	Power	Price
565182	<input type="checkbox"/> White	3000 K	25.0 W	€ 139.95
565183	<input type="checkbox"/> White	4000 K	25.6 W	€ 139.95

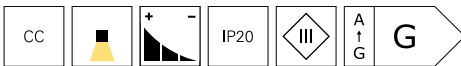

Accessories

862198	BASIC, CC, V8-30-700mA/30W		€ 26.95
862208	BASIC, DIM, CC, D70040NTF/40W		€ 46.95
862192	BASIC, DIM, Multi CC, IE-45D		€ 69.95



COB 210 MAX

- Plug on the luminaire housing
- incl. two diffuser discs [clear, satinised]

Housing	Aluminium	Light Beam Angle	60 Degree
Height	99 mm	Cut Out Ø	210 mm
Ø	230 mm	Control	Dimmable via optional power supply unit
Power	37 W	Colour Rendering Index (Ra)	90
Rated Input Voltage	35 V/DC	Rated Current	1050 mA
Power Supply Unit incl.	No		
Installation Depth	99 mm		

Article	Housing Color	Colour Temperature	Luminous Flux	Price
565184	<input type="checkbox"/> White	3000 K	3000 lm	€ 179.95
565185	<input type="checkbox"/> White	4000 K	3200 lm	€ 179.95

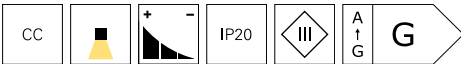

Accessories

862201	BASIC, CC, V8-40-1050mA/40V		€ 29.95
862209	BASIC, DIM, CC, D105040NTF/40W		€ 46.95
862193	BASIC, DIM, Multi CC, IE-45HD		€ 69.95





MODULAR SYSTEM COB 31 W

The MODULAR recessed ceiling light range offers a wide range of possible applications. Whether virtually invisible or with a prominent frame - these modules are as flexible as you want them to be. By replacing the reflectors, different light beams can be created and by using filters / diffusers, you can individually select or retrofit your lighting mood. We offer the LED modules in warm and neutral white. This gives you the option of adapting the individual elements to local requirements in order to create your perfect lighting situation.





MODULAR SYSTEM COB 31 W

·Luminaire can be customized with a range of accessories

Housing	Aluminium	Power Supply Unit incl.	No
Height	103 mm	Light Beam Angle	60 Degree
Ø	85 mm	Colour Rendering Index (Ra)	90
Power	31 W	Rated Current	900 mA
Rated Input Voltage	35-36 V/DC		

Article	Housing Color	Colour Temperature	Luminous Flux	Price
565352	Grey	3000 K	3270 lm	€ 119.95
565353	Grey	4000 K	3350 lm	€ 119.95



Accessories

930084	Reflector 17° for Modular System COB		€ 19.95
930085	Reflector 40° for Modular System COB		€ 19.95
930087	Frosted glass diffuser for Modular System COB		€ 1.25
930088	Honeycomb filter for Modular System COB		€ 5.95
930089	170 mm recessed ring for Modular System COB		€ 22.95
930090	230 mm recessed ring for Modular System COB		€ 29.95
930091	Swivelling recessed ring for Modular System COB		€ 32.95
930092	Cardan frame for Modular System COB		€ 36.95
930093	Cardan frame for Modular System COB		€ 66.95
930094	Cardan insert without frame for Modular System COB		€ 89.95
930095	Cardan insert without frame for Modular System COB		€ 89.95
930096	Cardan insert without frame for Modular System COB		€ 115.95
930097	Cardan insert without frame for Modular System COB		€ 115.95
862157	BASIC, CC, V8-40-900/40W		€ 29.95
862264	BASIC, DIM, CC, D090040NTF/40W		€ 46.95
862192	BASIC, DIM, Multi CC, IE-45D		€ 69.95



DAMP

Housing	Aluminium	Rated Input Voltage	12 V/AC/DC
Height	42 mm	Cut Out Ø	72 mm
Ø	84 mm	Control	Dimmable via optional light source
Installation Depth	85 mm		
Max. Power	1x max. 35 W		

Article	Housing Color	Surface	Price
110000	<input type="checkbox"/> White		€ 17.95
110001	<input type="checkbox"/> Silver Matt		€ 17.95
110002	<input type="checkbox"/> Silver Shiny		€ 17.95



Accessories

829063	Safety spacer		€ 5.95
---------------	---------------	---	---------------



Lighting design

Interested in our lighting design service?

Your contact person will be happy to answer any questions you may have.



PUNTO LUMI

- suitable for damp areas
- filigree luminaire for furniture / ceiling installation
- small installation diameter

Housing	Aluminium	Power Supply Unit incl.	No
Colour Temperature	3000 K	Installation Depth	30 mm
Luminous Flux	40 lm	Light Beam Angle	50 Degree
Height	25 mm	Cut Out Ø	18 mm
Ø	30 mm	Colour Rendering Index (Ra)	80
Power	1 W	Rated Current	350 mA
Rated Input Voltage	3.1-3.9 V/DC		

Article	Housing Color		Price
565172	<input type="checkbox"/> White		€ 17.95
565173	<input type="checkbox"/> Silver		€ 17.95



Accessories

872628 FLAT, CC, UT350mA/6W



€ 17.95



5-year guarantee

Benefit from the maximum quality promise:

All DEKO-LIGHT brand products come with a five-year manufacturer's guarantee.



ACRUX

All ACRUX-series recessed lights have a special feature: The switch on the back allows the light temperature [3,000, 4,000, 6,000 K] to be set before installation. This enables a great deal of flexibility in the planning phase. The light intensity can be individually controlled via leading-edge/trailing-edge phase dimmers. The respective supplied cover can be easily removed if required, so that the lamp can also be installed with its housing colour [white]. An integrated diffusing lens reduces glare, creating a pleasant lighting ambience.





ACRUX

- Integrated power supply unit
- Light colour adjustable in three levels
- incl. removable ring in silver / black [depending on model]
- Basic housing white, can also be used without colour ring

Housing	Plastic	Control	Leading-edge dimmer, Trailing-edge dimmer
Colour Temperature	3000/4000/6000 K		
Rated Input Voltage	220-240 V/AC		
Power Supply Unit incl.	Yes	Colour Rendering Index (Ra)	80
Light Beam Angle	90 Degree		

Article	Housing Color		Luminous Flux	Ø cut out	Ø	Power	Installation Depth	Price
565315	☐ White, Silver	WW NW CW	630 lm	68 mm	95 mm	7.0 W	55 mm	€ 24.95
565362	▣ White, Black	WW NW CW	630 lm	68 mm	95 mm	7.0 W	55 mm	€ 24.95
565316	☐ White, Silver	WW NW CW	760 lm	90 mm	113 mm	8.0 W	55 mm	€ 29.95
565363	▣ White, Black	WW NW CW	760 lm	90 mm	113 mm	8.0 W	55 mm	€ 29.95
565317	☐ White, Silver	WW NW CW	1370 lm	120 mm	145 mm	14.5 W	63 mm	€ 34.95
565364	▣ White, Black	WW NW CW	1370 lm	120 mm	145 mm	14.5 W	63 mm	€ 34.95
565318	☐ White, Silver	WW NW CW	1570 lm	145 mm	174 mm	16.0 W	63 mm	€ 39.95
565365	▣ White, Black	WW NW CW	1570 lm	145 mm	174 mm	16.0 W	63 mm	€ 39.95
565332	☐ White, Silver	WW NW CW	2670 lm	195 mm	244 mm	26.0 W	82 mm	€ 54.95
565366	▣ White, Black	WW NW CW	2670 lm	195 mm	244 mm	26.0 W	82 mm	€ 54.95





ZAURAK

Recessed ceiling lights can be subtly integrated into private and commercial spaces, yet when it comes to replacing, the existing ceiling cut-out can present a problem. The ZAURAK series comes with an adjustable mounting clip, which can be used with larger and smaller ceiling cut-outs. In addition, the ZAURAK has a low installation depth for universal use. Two exchangeable cover rings in silver and black are included in the scope of delivery.





ZAURAK

- Light colour adjustable in three stages
- Power adjustable in two stages
- adjustable cut-out dimension 65-270mm [depending on model]
- ideal refurbishment solution for ceiling cut-outs
- incl. two colour rings [black / silver]

Housing	Plastic	Light Beam Angle	110 Degree
Colour Temperature	3000/4000/5700 K	Colour Rendering Index (Ra)	80
Rated Input Voltage	220-240 V/AC	IK Protection Class	IK03
Power Supply Unit incl.	Yes		

Article	Housing Color		Luminous Flux	Height	Ø	Power Selectable	Cut Out Ø	Price
565327	<input type="checkbox"/> White	WW NW CW	1060 lm	20.5 mm	180 mm	8.0 W / 12.0 W	65-160 mm	€ 46.95
565328	<input type="checkbox"/> White	WW NW CW	1750 lm	21.5 mm	220 mm	12.0 W / 18.0 W	120-200 mm	€ 56.95
565329	<input type="checkbox"/> White	WW NW CW	2420 lm	25 mm	300 mm	18.0 W / 25.0 W	150-270 mm	€ 79.95

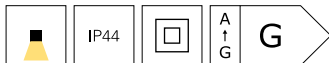



LED PANEL ROUND III 6 + 12

The recessed ceiling lights in the LED PANEL ROUND III series for indoor use are available in two light colours (3,000 K / 4,000 K) and four wattages (6 W, 12 W, 20 W, 26 W). With their low installation depth (32 mm) and neutral, white housing design, the aluminium ceiling spots are suitable for a wide range of applications and can be individually combined and dimmed with a power supply unit.



LED PANEL ROUND III 6 + 12

·Can be individually combined with power supply unit [excl.]

Housing	Aluminium	Colour Rendering Index (Ra)	80
Power Supply Unit incl.	No	Rated Current	350 mA
Light Beam Angle	100 Degree		
Control	Dimmable via optional power supply unit		

Article	Housing Color	Colour Temperature	Luminous Flux	Height	Ø cut out	Ø	Power	Price
565229	<input type="checkbox"/> White	3000 K	620 lm	34 mm	90 mm	106 mm	6.3 W	€ 59.59
565231	<input type="checkbox"/> White	3000 K	1310 lm	36 mm	125 mm	140 mm	12.5 W	€ 79.95
565230	<input type="checkbox"/> White	4000 K	630 lm	34 mm	90 mm	106 mm	6.3 W	€ 59.95
565232	<input type="checkbox"/> White	4000 K	1320 lm	36 mm	125 mm	140 mm	12.5 W	€ 79.95

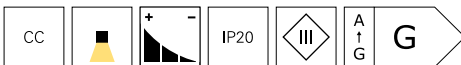

Accessories

180512 BASIC, CC, CC35018/18W  **€ 23.95**

Accessories for **565229, 565230**

862190 BASIC, DIM, Multi CC, IE-12D  **€ 59.95**

862202 BASIC, DIM, CC, D35009UF/9W  **€ 28.95**

862223 FLAT, CC, UT350mA/12W  **€ 24.95**

Accessories for **565231, 565232**

862191 BASIC, DIM, Multi CC, IE-25D  **€ 64.95**

862204 BASIC, DIM, CC, D35020UF/20W  **€ 39.95**



LED PANEL ROUND III 20 + 26

·Can be individually combined with power supply unit [excl.]

Housing	Aluminium	Control	Dimmable via optional power supply unit
Height	38 mm		
Power Supply Unit incl.	No		
Installation Depth	36 mm	Colour Rendering Index (Ra)	80
Light Beam Angle	100 Degree	Rated Current	700 mA

Article	Housing Color	Colour Temp.	Luminous Flux	Ø cut out	Ø	Power	Rated Input Voltage	Price
565233	<input type="checkbox"/> White	3000 K	1980 lm	160 mm	180 mm	20.0 W	28 V/DC	€ 99.95
565235	<input type="checkbox"/> White	3000 K	2680 lm	200 mm	230 mm	26.0 W	37 V/DC	€ 109.95
565234	<input type="checkbox"/> White	4000 K	1970 lm	160 mm	180 mm	20.0 W	28 V/DC	€ 99.95
565236	<input type="checkbox"/> White	4000 K	2690 lm	200 mm	230 mm	26.0 W	37 V/DC	€ 109.95

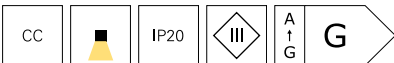

Accessories

862198 BASIC, CC, V8-30-700mA/30W  **€ 26.95**

Accessories for **565233, 565234**

862191 BASIC, DIM, Multi CC, IE-25D  **€ 64.95**

862207 BASIC, DIM, CC, D70020UF/20W  **€ 39.95**

Accessories for **565235, 565236**

862192 BASIC, DIM, Multi CC, IE-45D  **€ 69.95**

862208 BASIC, DIM, CC, D70040NTF/40W  **€ 46.95**



LED PANEL SQUARE 8 + 15 + 20

·Can be individually combined with power supply unit [excl.]

Housing	Aluminium	Control	Dimmable via optional power supply unit
Power Supply Unit incl.	No		
Installation Depth	20 mm	Colour Rendering Index (Ra)	80
Light Beam Angle	110 Degree		

Article	Housing Color	Colour Temp.	Luminous Flux	L x B cut out	Length	Width	EEL	Price
565152	<input type="checkbox"/> White	2700 K	560 lm	90x90 mm	110 mm	110 mm		€ 34.95
565153	<input checked="" type="checkbox"/> Grey	2700 K	560 lm	90x90 mm	110 mm	110 mm		€ 34.95
565156	<input type="checkbox"/> White	2700 K	1000 lm	155x155 mm	180 mm	180 mm		€ 59.95
565157	<input checked="" type="checkbox"/> Grey	2700 K	1000 lm	155x155 mm	180 mm	180 mm		€ 59.95
565160	<input type="checkbox"/> White	2700 K	1560 lm	215x215 mm	237 mm	237 mm		€ 74.95
565161	<input checked="" type="checkbox"/> Grey	2700 K	1560 lm	215x215 mm	237 mm	237 mm		€ 74.95
565154	<input type="checkbox"/> White	4000 K	560 lm	90x90 mm	110 mm	110 mm		€ 34.95
565155	<input checked="" type="checkbox"/> Grey	4000 K	560 lm	90x90 mm	110 mm	110 mm		€ 34.95
565158	<input type="checkbox"/> White	4000 K	1130 lm	155x155 mm	180 mm	180 mm		€ 59.95
565159	<input checked="" type="checkbox"/> Grey	4000 K	1130 lm	155x155 mm	180 mm	180 mm		€ 59.95
565162	<input type="checkbox"/> White	4000 K	1740 lm	215x215 mm	237 mm	237 mm		€ 74.95
565163	<input checked="" type="checkbox"/> Grey	4000 K	1740 lm	215x215 mm	237 mm	237 mm		€ 74.95



Accessories for **565152, 565153, 565154, 565155**

862202	BASIC, DIM, CC, D35009UF/9W		€ 28.95
---------------	-----------------------------	--	----------------

Accessories for **565153, 565154, 565155**

862190	BASIC, DIM, Multi CC, IE-12D		€ 59.95
---------------	------------------------------	--	----------------

862223	FLAT, CC, UT350mA/12W		€ 24.95
---------------	-----------------------	--	----------------

Accessories for **565156, 565157, 565158, 565159**

180512	BASIC, CC, CC35018/18W		€ 23.95
---------------	------------------------	--	----------------

862204	BASIC, DIM, CC, D35020UF/20W		€ 39.95
---------------	------------------------------	--	----------------

Accessories for **565156, 565157, 565158, 565159, 565160, 565161, 565162, 565163**

862191	BASIC, DIM, Multi CC, IE-25D		€ 64.95
---------------	------------------------------	--	----------------

Accessories for **565160, 565161, 565162, 565163**

862207	BASIC, DIM, CC, D70020UF/20W		€ 39.95
---------------	------------------------------	--	----------------



LED PANEL 8 + 12 + 16

•Can be individually combined with power supply unit [excl.]

Housing	Aluminium	Control	Dimmable via optional power supply unit
Power Supply Unit incl.	No		
Light Beam Angle	115 Degree	Colour Rendering Index (Ra)	80

Article	Housing Color	Colour Temp.	Luminous Flux	Ø cut out	Height	Ø	Power	Price
565082	<input type="checkbox"/> White	2700 K	590 lm	135 mm	18 mm	145 mm	7.0 W	€ 39.95
565083	<input checked="" type="checkbox"/> Grey	2700 K	590 lm	135 mm	18 mm	145 mm	7.0 W	€ 39.95
565088	<input type="checkbox"/> White	2700 K	820 lm	169 mm	20 mm	180 mm	9.0 W	€ 55.95
565089	<input checked="" type="checkbox"/> Grey	2700 K	820 lm	169 mm	20 mm	180 mm	9.0 W	€ 55.95
565094	<input type="checkbox"/> White	2700 K	1260 lm	222 mm	20 mm	236 mm	13.0 W	€ 77.95
565095	<input checked="" type="checkbox"/> Grey	2700 K	1260 lm	222 mm	20 mm	236 mm	13.0 W	€ 77.95
565084	<input type="checkbox"/> White	4000 K	610 lm	135 mm	18 mm	145 mm	7.0 W	€ 39.95
565085	<input checked="" type="checkbox"/> Grey	4000 K	610 lm	135 mm	18 mm	145 mm	7.0 W	€ 39.95
565090	<input type="checkbox"/> White	4000 K	870 lm	169 mm	20 mm	180 mm	9.0 W	€ 55.95
565091	<input checked="" type="checkbox"/> Grey	4000 K	870 lm	169 mm	20 mm	180 mm	9.0 W	€ 55.95
565096	<input type="checkbox"/> White	4000 K	1150 lm	222 mm	20 mm	236 mm	13.0 W	€ 77.95
565097	<input checked="" type="checkbox"/> Grey	4000 K	1150 lm	222 mm	20 mm	236 mm	13.0 W	€ 77.95

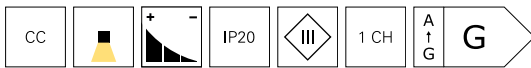

Accessories for **565082, 565083, 565084, 565085**

862202 BASIC, DIM, CC, D35009UF/9W  **€ 28.95**

Accessories for **565082, 565083, 565084, 565085, 565088, 565089, 565090, 565091**

180512 BASIC, CC, CC35018/18W  **€ 23.95**

862190 BASIC, DIM, Multi CC, IE-12D  **€ 59.95**

Accessories for **565088, 565089, 565090, 565091**

862203 BASIC, DIM, CC, D350012UF/12W  **€ 36.95**

Accessories for **565094, 565095, 565096, 565097**

180514 BASIC, CC, CC70018/18W  **€ 23.95**

862207 BASIC, DIM, CC, D70020UF/20W  **€ 39.95**

862246 Multi CC, LCM-25DA2 / DALI2 + DALI1  **€ 89.95**



LED PANEL 8 + 16

- Can be individually combined with power supply unit [excl.]
- suitable for 24 V HCL control units

Housing	Aluminium	Control	Dimmable via optional controller
Colour Temperature	2700-6000 K	Colour Rendering Index (Ra)	80
Rated Input Voltage	24 V/DC		
Power Supply Unit incl.	No		
Light Beam Angle	115 Degree		

Article	Housing Color		Luminous Flux	Ø cut out	Ø	Power	Installation Depth	Price
565102	<input type="checkbox"/> White		470 lm	135 mm	145 mm	8.5 W	18 mm	€ 55.95
565103	<input type="checkbox"/> White		940 lm	222 mm	236 mm	15.0 W	20 mm	€ 85.95

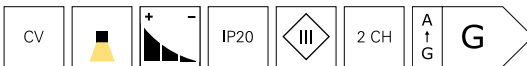

Accessories

843501 RF-smart, Starter-Set LED Single/CCT, 12-48V, 20A remote control incl.  **€ 99.95**

Accessories for 565102

862166 BASIC, CV, Q8H-24-100W  **€ 96.95**

862233 FLAT, CV, UT24V/12W  **€ 21.95**

Accessories for 565103

862168 BASIC, CV, Q8H-24-150W  **€ 129.95**

862234 FLAT, CV, UT24V/20W  **€ 25.95**



Lighting design

Interested in our lighting design service?

Your contact person will be happy to answer any questions you may have.



LED PANEL 8 RGBW

- Can be individually combined with power supply unit [excl.]
- suitable for 24 V colour controls

Housing	Aluminium	Installation Depth	18 mm
Colour Temperature	3000 K	Light Beam Angle	115 Degree
Luminous Flux	140 lm	Cut Out Ø	135 mm
Height	18 mm	Control	Dimmable via optional controller
Ø	145 mm	Colour Rendering Index (Ra)	80
Power	8 W		
Rated Input Voltage	24 V/DC		
Power Supply Unit incl.	No		

Article	Housing Color		Price
565248	<input type="checkbox"/> White	RGB WW	€ 59.95

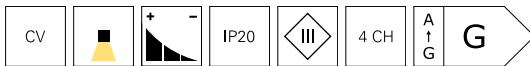

Accessories

862233	FLAT, CV, UT24V/12W		€ 21.95
862166	BASIC, CV, Q8H-24-100W		€ 96.95
843502	RF-smart, Starter-Set RGBW/CCT, 12-48V, 20A remote control, IP20 incl.		€ 99.95

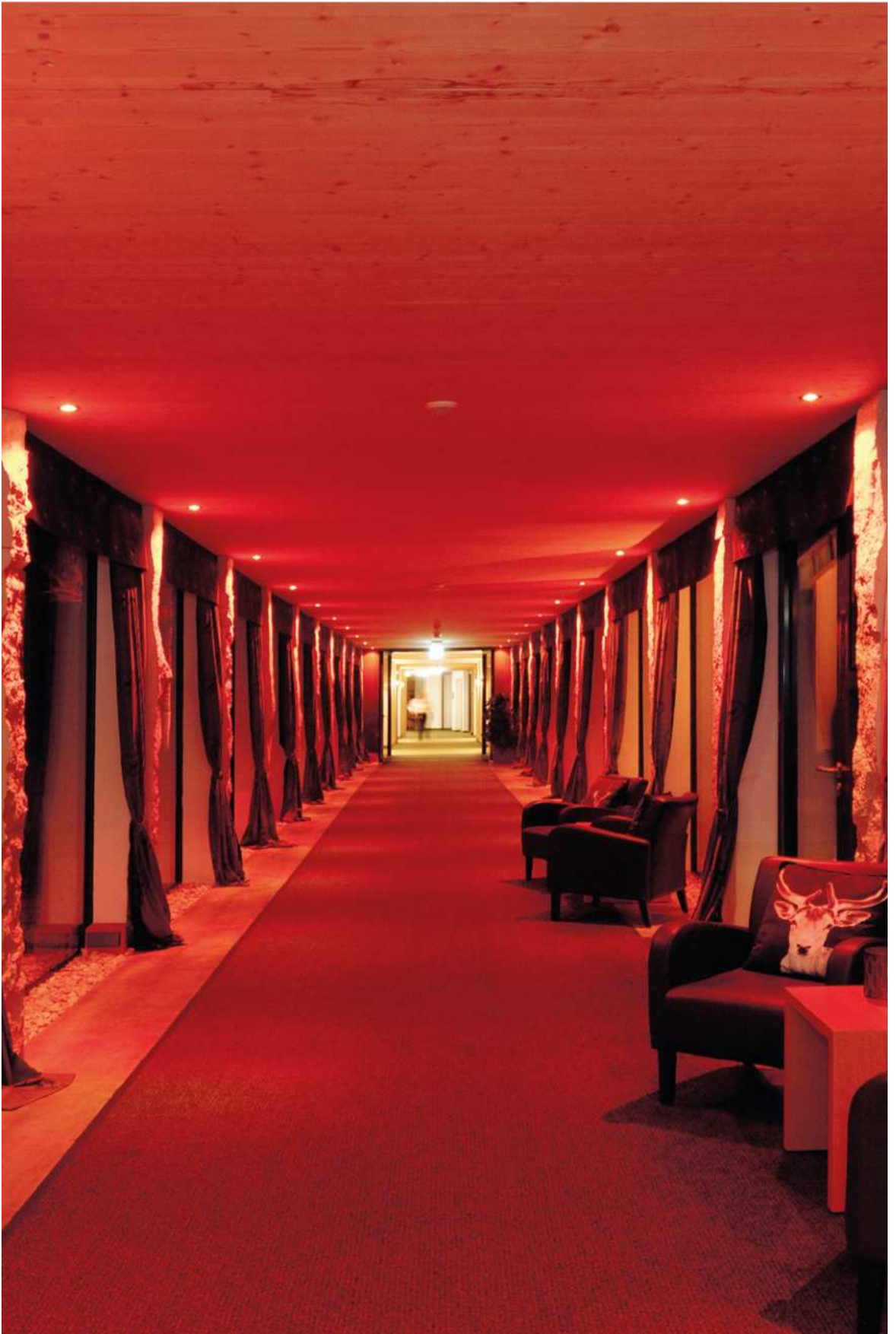



UNI II













- „Glow“ effect on the reflector ring
- Can be rotated and swivelled
- Can be individually combined with power supply unit [excl.]

Housing	Aluminium	Light Beam Angle	36 Degree
Colour Temperature	3000 K	Swivelling Angle	85 Degree
Luminous Flux	1035 lm	Cut Out Ø	125 mm
Height	84 mm	Control	Dimmable via optional power supply unit
Ø	139 mm	Colour Rendering Index (Ra)	90
Power	12 W	Rated Current	350 mA
Rated Input Voltage	33-34 V/DC		
Power Supply Unit incl.	No		
Installation Depth	90 mm		



Article	Housing Color		Price
565343	<input type="checkbox"/> White		€ 119.95
565361	<input checked="" type="checkbox"/> Black		€ 119.95



Accessories

930305	Reflector 36° for series Klara / Nihal Mini / Rigel Mini / Uni II		€ 3.6
930306	Reflector 48° for series Klara / Nihal Mini / Rigel Mini / Uni II		€ 8.95
930307	Honeycomb filter for series Klara / Nihal Mini / Rigel Mini / Uni II		€ 8.95
930308	Spread lense for series Klara / Nihal Mini / Rigel Mini / Uni II		€ 8.95
930309	Softening lense for series Klara / Nihal Mini / Rigel Mini / Uni II		€ 8.95
930310	Linear spread lense for series Klara / Nihal Mini / Rigel Mini / Uni II		€ 8.95
930334	Cover back white for series Uni II		€ 3.55
930335	Cover back black for series Uni II		€ 2.95
930336	Cover heatsink white for series Uni II		€ 3.55
930337	Cover heatsink black for series Uni II		€ 7.95
930339	Reflector ring black for series Uni II		€ 10.95
930340	Reflector ring gold for series Uni II		€ 10.95
930341	Reflector ring chrome for series Uni II		€ 10.95

Accessories

180512	BASIC, CC, CC35018/18W		€ 23.95
862204	BASIC, DIM, CC, D35020UF/20W		€ 39.95
862191	BASIC, DIM, Multi CC, IE-25D		€ 64.95



page 70



page 172



page 366



Technical data sheet

New in the onlineshop: The technical data sheets offer even more information: Light and energy data, light distribution curves, dimensional drawings and more.



UNI II MINI

- „Glow“ effect on the reflector ring
- Can be rotated and swivelled
- Can be individually combined with power supply unit [excl.]

Housing	Aluminium	Light Beam Angle	36 Degree
Colour Temperature	3000 K	Swivelling Angle	75 Degree
Luminous Flux	670 lm	Cut Out Ø	95 mm
Height	80 mm	Control	Dimmable via optional power supply unit
Ø	103 mm	Colour Rendering Index (Ra)	90
Power	9 W	Rated Current	500 mA
Rated Input Voltage	18-19 V/DC		
Power Supply Unit incl.	No		
Installation Depth	85 mm		

Article	Housing Color		Price
565342	<input type="checkbox"/> White		€ 99.95
565354	<input checked="" type="checkbox"/> Black		€ 99.95



Accessories

930328	Cover heatsink white for series Uni II Mini		€ 3.55
930329	Cover heatsink black for series Uni II Mini		€ 2.95
930330	Reflector ring white for series Uni II Mini		€ 10.95
930331	Reflector ring black for series Uni II Mini		€ 10.95
930332	Reflector ring gold for series Uni II Mini		€ 10.95
930333	Reflector ring chrome for series Uni II Mini		€ 10.95
930770	Reflector 24° for series Uni II Mini		€ 10.95
930771	Reflector 48° for series Uni II Mini		€ 10.95
180513	BASIC, CC, CC50018/18W		€ 23.95
862236	OCTO, DIM, CC, RSM-12-500T/12W		€ 29.95
862190	BASIC, DIM, Multi CC, IE-12D		€ 59.95



UNI II MAX

- „Glow“ effect on the reflector ring
- Can be rotated and swivelled
- Can be individually combined with power supply unit [excl.]

Housing	Aluminium	Light Beam Angle	36 Degree
Colour Temperature	3000 K	Swivelling Angle	85 Degree
Luminous Flux	2150 lm	Cut Out Ø	155 mm
Height	97 mm	Control	Dimmable via optional power supply unit
Ø	165 mm	Colour Rendering Index (Ra)	90
Power	24 W	Rated Current	700 mA
Rated Input Voltage	34-35 V/DC		
Power Supply Unit incl.	No		
Installation Depth	100 mm		

Article	Housing Color		Price
565344	<input type="checkbox"/> White		€ 149.95
565351	<input checked="" type="checkbox"/> Black		€ 149.95



Accessories

930390	Reflector 24° for Uni II Max		€ 10.95
930391	Reflector 36° for Uni II Max		€ 12.95
930392	Reflector 48° for Uni II Max		€ 10.95
930395	Cover heatsink white for series Uni II Max		€ 10.95
930396	Cover heatsink black for series Uni II Max		€ 10.95
930397	Reflector ring white for series Uni II Max		€ 12.95
930398	Reflector ring black for series Uni II Max		€ 10.95
930399	Reflector ring gold for series Uni II Max		€ 14.95
862198	BASIC, CC, V8-30-700mA/30W		€ 26.95
862208	BASIC, DIM, CC, D70040NTF/40W		€ 46.95
862192	BASIC, DIM, Multi CC, IE-45D		€ 69.95



CETI 5

With its five LED light sources, the CETI 5 recessed ceiling light produces a glare-free, warm white light (3,000 K). The recessed reflectors of the luminaire make a major contribution to this. The interchangeable coloured reflector inserts in silver and gold offer additional design options. The CETI 5 can be individually combined with a power supply unit and dimmed.



CETI 5

- highly glare-free light
- recessed reflectors
- interchangeable coloured reflector inserts
- can be individually combined with power supply unit [excl.]

Housing	Aluminium	Installation Depth	50 mm
Colour Temperature	3000 K	Light Beam Angle	45 Degree
Luminous Flux	800 lm	Cut Out Length	130 mm
Length	137 mm	Cut Out Width	36 mm
Width	52 mm	Control	Dimmable via optional power supply unit
Height	44 mm	Colour Rendering Index (Ra)	90
Power	10.5 W	Rated Current	700 mA
Rated Input Voltage	14-15 V/DC		
Power Supply Unit incl.	No		

Article Housing Color Price

565250 White **ww** **€ 109.95**

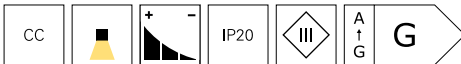

Accessories

930215	Ceti 5 reflector gold		€ 9.95
930218	Ceti 5 reflector silver		€ 9.95
862227	FLAT, CC, UT700mA/12W		€ 24.95
862237	OCTO, DIM, CC, RSM-12-700T/12W		€ 29.95



Technical data sheet

New in the onlineshop: The technical data sheets offer even more information: Light and energy data, light distribution curves, dimensional drawings and more.



CETI 10



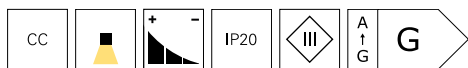

- highly glare-free light
- recessed reflectors
- interchangeable coloured reflector inserts
- can be individually combined with power supply unit [excl.]

Housing	Aluminium	Installation Depth	50 mm
Colour Temperature	3000 K	Light Beam Angle	45 Degree
Luminous Flux	1600 lm	Cut Out Length	250 mm
Length	257 mm	Cut Out Width	36 mm
Width	52 mm	Control	Dimmable via optional power supply unit
Height	44 mm	Colour Rendering Index (Ra)	90
Power	20.2 W	Rated Current	700 mA
Rated Input Voltage	28-29 V/DC		
Power Supply Unit incl.	No		

Article	Housing Color	Price
565251	<input type="checkbox"/> White 	€ 179.95



Accessories

930216	Ceti 10 reflector gold		€ 10.95
930219	Ceti 10 reflector silver		€ 10.95
862198	BASIC, CC, V8-30-700mA/30W		€ 26.95
862207	BASIC, DIM, CC, D70020UF/20W		€ 39.95
862191	BASIC, DIM, Multi CC, IE-25D		€ 64.95



CETI 15



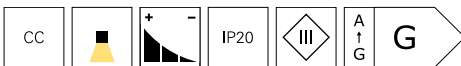

- highly glare-free light
- recessed reflectors
- interchangeable coloured reflector inserts
- can be individually combined with power supply unit [excl.]

Housing	Aluminium	Installation Depth	50 mm
Colour Temperature	3000 K	Light Beam Angle	45 Degree
Luminous Flux	2400 lm	Cut Out Length	369 mm
Length	376 mm	Cut Out Width	36 mm
Width	52 mm	Control	Dimmable via optional power supply unit
Height	44 mm	Colour Rendering Index (Ra)	90
Power	30.8 W	Rated Current	700 mA
Rated Input Voltage	44-45 V/DC		
Power Supply Unit incl.	No		

Article	Housing Color		Price
565252	<input type="checkbox"/> White	ww	€ 249.95



Accessories

930217	Ceti 15 reflector gold		€ 14.95
930220	Ceti 15 reflector silver		€ 14.95
862199	BASIC, CC, V8-40-700mA/40W		€ 29.95
862208	BASIC, DIM, CC, D70040NTF/40W		€ 46.95
862192	BASIC, DIM, Multi CC, IE-45D		€ 69.95

insert panels



page 150



page 154



page 155



page 156



page 158



page 162



page 164



page 165



page 166



page 167



page 168



page 169





LED PANEL SMALL

In the ceiling or on the ceiling - the LED PANEL 3K SMALL impresses in any variant. In addition to the optionally available frame for ceiling recessing or ceiling mounting, the compact LED Panel (optionally available as 3,000 K or 4,000 K version) can be flexibly dimmed using a separate power supply. This makes the LED PANEL 3K SMALL a capable modern ceiling light for office spaces, public administration buildings, catering establishments and many others.



LED PANEL SMALL

- Can be mounted in surface-mounted and recessed frames
- For insertion into grid ceilings
- Can be individually combined with power supply unit [excl.]

Housing	Aluminium	Power Supply Unit incl.	No
Luminous Flux	2500 lm	Light Beam Angle	115 Degree
Length	295 mm	Control	Dimmable via optional power supply unit
Width	295 mm	Colour Rendering Index (Ra)	80
Height	10 mm	Rated Current	700 mA
Power	24 W		
Rated Input Voltage	34-35 V/DC		

Article	Housing Color	Colour Temperature	Price
565220	<input type="checkbox"/> White	3000 K	€ 75.95
565221	<input type="checkbox"/> White	4000 K	€ 75.95



Accessories

930167	Built-up frame 30x30		€ 29.95
930230	Insert frame for gypsum 30x30		€ 29.95
862198	BASIC, CC, V8-30-700mA/30W		€ 26.95
862208	BASIC, DIM, CC, D70040NTF/40W		€ 46.95
862192	BASIC, DIM, Multi CC, IE-45D		€ 69.95

BACKLIGHT PANELS [SERIES: BASIC AND PRO] – TECHNOLOGY AND ADVANTAGES

Not every LED panel is built the same! There are technologies exist to produce homogeneous, flat and glare-free light. Each method has its own advantages and disadvantages and depends on the individual user requirements and budget needs. For example, the LED panels from our BASIC and PRO series rely on backlight technology.

In LED panels with backlight technology, the LEDs - behind the diffuser - are evenly spread over the entire panel surface and shine directly downwards. This design has a decisive advantage: no other components are required to direct the light in the desired direction [downwards], because the LEDs are already in the »right« position. The simpler design results above all in better efficiency and a lower price as well as a longer lifetime. At the same time you do not have to worry about possible yellowing of the light guide plate, which is often used in some cheaper sidelight panels.

The disadvantages: Due to their design, the LED elements require more space, which is why backlight panels are curved towards the backside and therefore have a higher thickness with it. For this [optical] reason, backlight panels are only suitable to a limited extent for suspension from the ceiling. Their smaller beam angle [approx. 90°] results in a smaller illuminated area.

advantages

- better efficiency
- longer lifetime
- lower costs
- much more attractive price/performance ratio
- no light guide plates that are prone to yellowing

disadvantages

- higher thickness
- lower beam angle [approx. 90°]
- less suitable for suspension
- thicker packaging

In the following picture you can see the typical structure of a backlight LED panel.





BASIC

- BEG-eligible, Cost-effective, ready-to-connect solution
- For insertion in grid ceilings
- Installation in surface-mounted and recessed frames possible
- Refurbishment solution for T5/T8 louvre luminaires
- incl. CC power supply unit, 900mAh, 33-38V, 36W

Housing	Aluminium	Light Beam Angle	120 Degree
Height	32 mm	Colour Rendering Index (Ra)	80
Power	30.5 W	IK Protection Class	IK03
Rated Input Voltage	220-240 V/AC	UGR	22
Power Supply Unit incl.	Yes		

Article	Housing Color	Colour Temperature	Luminous Flux	Length	Width	Price
100143	<input type="checkbox"/> White	3000 K	3900 lm	295 mm	1195 mm	€ 79.95
100149	<input type="checkbox"/> White	3000 K	3900 lm	595 mm	595 mm	€ 69.95
100140	<input type="checkbox"/> White	3000 K	3900 lm	620 mm	620 mm	€ 74.95
100144	<input type="checkbox"/> White	4000 K	4320 lm	295 mm	1195 mm	€ 79.95
100150	<input type="checkbox"/> White	4000 K	4320 lm	595 mm	595 mm	€ 69.95
100141	<input type="checkbox"/> White	4000 K	4320 lm	620 mm	620 mm	€ 74.95

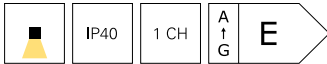

Accessories

930674	Safety rope		€ 4.95
930676	Installation bracket for 600x600/300x1200mm Backlit Panel		€ 4.95
862192	BASIC, DIM, Multi CC, IE-45D		€ 69.95

Accessories for **100140, 100141**

930665	Built-up frame for 620x620mm Panel		€ 59.95
930668	Recessed frame for 620x620mm Panel		€ 57.95

Accessories for **100143, 100144**

930666	Built-up frame for 300x1200mm Panel		€ 69.95
930669	Recessed frame for 300x1200mm Panel		€ 67.95

Accessories for **100149, 100150**

930664	Built-up frame for 595x595mm Panel		€ 54.95
930667	Recessed frame for 595x595mm Panel		€ 52.95



BASIC FLEX



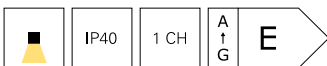

- **BEG-eligible**
- **Light colour adjustable in three stages**
- **For insertion into grid ceilings**
- **Mounting in surface-mounted and recessed frames possible**
- **Refurbishment solution for T5/T8 louvre luminaires**
- **incl. CC power supply unit, 900mAh, 33-38V, 36W**

Housing	Aluminium	Power Supply Unit incl.	Yes
Colour Temperature	3000/4000/6000 K	Light Beam Angle	120 Degree
Luminous Flux	3900/4320/4140 lm	Colour Rendering Index (Ra)	80
Height	32 mm	IK Protection Class	IK03
Power	30.5 W	UGR	22
Rated Input Voltage	220-240 V/AC		



Article	Housing Color		Length	Width	Price
100145	<input type="checkbox"/> White	ww nw cw	295 mm	1195 mm	€ 99.95
100142	<input type="checkbox"/> White	ww nw cw	620 mm	620 mm	€ 94.95





Accessories

930674	Safety rope		€ 4.95
930676	Installation bracket for 600x600/300x1200mm Backlit Panel		€ 4.95
862264	BASIC, DIM, CC, D090040NTF/40W		€ 46.95
862192	BASIC, DIM, Multi CC, IE-45D		€ 69.95

Accessories for 100142

930665	Built-up frame for 620x620mm Panel		€ 59.95
930668	Recessed frame for 620x620mm Panel		€ 57.95

Accessories for 100145

930666	Built-up frame for 300x1200mm Panel		€ 69.95
930669	Recessed frame for 300x1200mm Panel		€ 67.95



BASIC OFFICE

- For insertion in grid ceilings
- Mounting in surface-mounted and recessed frames possible
- Suitable for screen workstations in accordance with EN 12464-1 BAP65
- Microprismatic surface structure
- Suitable for offices, lounges and walkways
- Cost-effective ready-to-connect solution
- incl. power supply unit CC, 900mAh, 33-38V, 36W

Housing	Aluminium	Power Supply Unit incl.	Yes
Colour Temperature	4000 K	Light Beam Angle	90 Degree
Luminous Flux	4000 lm	Colour Rendering Index (Ra)	80
Height	32 mm	IK Protection Class	IK03
Power	30.5 W	UGR	19
Rated Input Voltage	220-240 V/AC		

Article	Housing Color	Length	Width	Price
100147	<input type="checkbox"/> White	295 mm	1195 mm	€ 89.95
100151	<input type="checkbox"/> White	595 mm	595 mm	€ 79.95
100146	<input type="checkbox"/> White	620 mm	620 mm	€ 84.95



Accessories

930674	Safety rope		€ 4.95
930676	Installation bracket for 600x600/300x1200mm Backlit Panel		€ 4.95
862264	BASIC, DIM, CC, D090040NTF/40W		€ 46.95
862192	BASIC, DIM, Multi CC, IE-45D		€ 69.95

Accessories for 100146

930665	Built-up frame for 620x620mm Panel		€ 59.95
930668	Recessed frame for 620x620mm Panel		€ 57.95

Accessories for 100147

930666	Built-up frame for 300x1200mm Panel		€ 69.95
930669	Recessed frame for 300x1200mm Panel		€ 67.95

Accessories for 100151

930664	Built-up frame for 595x595mm Panel		€ 54.95
930667	Recessed frame for 595x595mm Panel		€ 52.95



living space

The BASIC series really comes into its own in private living areas: The included power supply unit simplifies installation and reduces acquisition costs. Users remain flexible thanks to the adjustment of the colour temperature [BASIC FLEX] and use in the home office [BASIC OFFICE].

- living rooms
- hallway/staircase
- home office



trade

In commercial environments, for example in shops or in the catering trade, the STANDARD series with its particularly flexible installation and extensive range of accessories is ideal. As an alternative for old T5 and T8 fluorescent tubes, we recommend our BEG-eligible SANO variant, which has been specially designed for refurbishment projects.

- shop fitting
- Bar/Restaurant
- Hotel
- trade fair



office

Neutrality and precision are essential in office environments and other workplaces. With the OFFICE and OFFICE FLEX versions, you can ensure glare-free light, high colour fidelity and support for DIN guideline EN 12464-1 BAP65. The PRO OFFICE version also impresses with its particularly high energy efficiency.

- office
- workplace
- warehouse



PRO OFFICE



- BEG-eligible
- for insertion in grid ceilings
- Installation in surface-mounted and recessed frames possible
- Highly efficient solution
- refurbishment solution for T5 / T8 louvre luminaires
- Suitable for offices / recreation rooms / path areas
- suitable for VDU workstations in accordance with EN 12464-1 BAP65
- Microprismatic surface structure
- can be individually combined with power supply unit [excl.]

Housing	Aluminium	Control	Dimmable via optional power supply unit
Height	32 mm		
Power	17 W		
Rated Input Voltage	35-40 V/DC	Colour Rendering Index (Ra)	80
Power Supply Unit incl.	No	Rated Current	450 mA
Light Beam Angle	90 Degree	IK Protection Class	IK03
		UGR	19



Article	Housing Color	Colour Temperature	Luminous Flux	Length	Width	EEL	Price
100084	<input type="checkbox"/> White	3000 K	2880 lm	620 mm	620 mm		€ 109.95
100089	<input type="checkbox"/> White	3000 K	2880 lm	1195 mm	295 mm		€ 114.95
100122	<input type="checkbox"/> White	4000 K	3200 lm	1195 mm	295 mm		€ 114.95
100148	<input type="checkbox"/> White	4000 K	3200 lm	595 mm	595 mm		€ 104.95
100088	<input type="checkbox"/> White	4000 K	3200 lm	620 mm	620 mm		€ 109.95





Accessories

930674	Safety rope		€ 4.95
930676	Installation bracket for 600x600/300x1200mm Backlit Panel		€ 4.95
862257	QUICK, CC, 450mA, 30-40V, 20W		€ 36.95
862191	BASIC, DIM, Multi CC, IE-25D		€ 64.95



Accessories for **100084, 100088**

930665	Built-up frame for 620x620mm Panel		€ 59.95
930668	Recessed frame for 620x620mm Panel		€ 57.95

Accessories for **100089, 100122**

930666	Built-up frame for 300x1200mm Panel		€ 69.95
930669	Recessed frame for 300x1200mm Panel		€ 67.95

Accessories for **100148**

930664	Built-up frame for 595x595mm Panel		€ 54.95
930667	Recessed frame for 595x595mm Panel		€ 52.95



Technical data sheet

New in the onlineshop: The technical data sheets offer even more information: Light and energy data, light distribution curves, dimensional drawings and more.

SIDELIGHT-PANELS [SERIES: STANDARD] – TECHNOLOGY AND ADVANTAGES

Not every LED panel is built the same! There are technologies exist to produce homogeneous, flat light. Each method has its own advantages and disadvantages and depends on the individual user requirements and budget needs. For example LED panels from our standard series use sidelight technology.

Unlike backlight panels, the LEDs are not spread over the entire panel surface, but are located on the side of the aluminum frame of the luminaire. Depending on the model and version, only one, two or all four sides are equipped with LED stripes. What all edgelit or sidelight panels have in common is that the LEDs shine into the center of the panel. The light must therefore still be redirected in order to radiate downwards.

The most important element here is the light guide plate. This is usually made of acrylic glass [also PMMA (poly-methyl methacrylate), a transparent thermoplastic material], which distributes the light evenly over the entire surface and deflects it downwards. In addition, acrylic glass does not yellow with age. In addition to the light guide plate, which deflects the light by means of small laser-engraved dots, the additional reflector, similar to the one the backlight panel, and the diffuser also contribute to the significantly more complex structure of a sidelight panel [see picture to the right].

The great advantage is the lower construction thickness, which is why edgelit panels can be integrated more discreetly in rooms and are better suited as pendant variants. At the same time, the panels allow a higher beam angle [approx. 120°] what results in a larger illuminated area. The disadvantages: Edgelit panels are more expensive and offer less efficiency and lifetime compared to backlight panels.

advantages

- lower thickness
- higher beam angle [approx. 120°]
- more suitable for suspension
- thinner packing

disadvantages

- higher costs
- worse price/performance ratio
- average lifetime
- lower efficiency

In the following picture you can see the typical structure of a sidelight LED panel.



aluminium frame mithit LEDs

microprismatic diffusing lens

diffuser disc

light guide panel

reflector insert

EVA [ethylene vinyl acetate copolymer] foam

back panel



STANDARD FLEX

- Light colour adjustable in three levels
- For insertion into grid ceilings
- Mounting in surface-mounted and recessed frames possible
- Suspension possible
- Suitable for lounges and path areas
- Can be individually combined with power supply unit [excl.]

Housing	Aluminium	Control	Dimmable via optional power supply unit
Colour Temperature	3000/4000/6000 K	Colour Rendering Index (Ra)	90
Height	10 mm	IK Protection Class	IK03
Rated Input Voltage	33-38 V/DC	UGR	22
Power Supply Unit incl.	No		
Light Beam Angle	120 Degree		

Article	Housing Color		Luminous Flux	Length	Width	Power	Rated Current	Price
100125	<input type="checkbox"/> White	WW NW CW	3570/3990/3780 lm	1195 mm	295 mm	36.0 W	1050 mA	€ 124.95
100123	<input type="checkbox"/> White	WW NW CW	3780/4200/4000 lm	620 mm	620 mm	36.0 W	1050 mA	€ 119.95
100139	<input type="checkbox"/> White	WW NW CW	5300/6000/5700 lm	1195 mm	595 mm	51.5 W	1500 mA	€ 219.95
100154	<input type="checkbox"/> White	WW NW CW	5300/6000/5700 lm	1240 mm	620 mm	51.5 W	1500 mA	€ 229.95

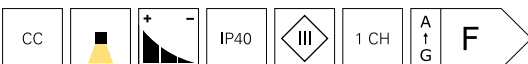

Accessories

930674 Safety rope  € 4.95

Accessories for **100123**

930665 Built-up frame for 620x620mm Panel  € 59.95

930670 Recessed frame for 620x620mm Backlit Panel  € 59.95

Accessories for **100123, 100125**

930672 Rope suspension for 620x620/300x1200mm Panel  € 22.95

862193 BASIC, DIM, Multi CC, IE-45HD  € 69.95

862258 QUICK, CC, 1,050 mA, 25-40 V, 45 W  € 46.95

Accessories for **100125**

930666 Built-up frame for 300x1200mm Panel  € 69.95

930671 Recessed frame for 300x1200mm Backlit Panel  € 69.95

Accessories for **100139**

930675 Built-up frame for 600x1200mm Panel  € 69.95

930688 Recessed frame for 600x1200mm Backlit Panel  € 84.95

Accessories for **100139, 100154**

930673 Rope suspension for 600x1200mm Panel  € 32.95

862194 BASIC, DIM, Multi CC, IE-75D  € 84.95

862259 QUICK, CC, 1500mA, 27-42V, 60W  € 56.95



Lighting design

Interested in our lighting design service?

Your contact person will be happy to answer any questions you may have.



STANDARD OFFICE

- For insertion into grid ceilings
- Mounting in surface-mounted and recessed frames possible
- Suspension possible
- Suitable for offices, lounges, path areas
- suitable for screen workstations in accordance with EN 12464-1 BAP65
- microprismatic surface structure

Housing	Aluminium	Control	Dimmable via optional power supply unit
Colour Temperature	4000 K		
Luminous Flux	4200 lm	Colour Rendering Index (Ra)	90
Height	9 mm	Rated Current	1050 mA
Power	36 W	IK Protection Class	IK03
Rated Input Voltage	33-38 V/DC	UGR	19
Power Supply Unit incl.	No		
Light Beam Angle	90 Degree		

Article	Housing Color	Length	Width	EEL	Price
100138	<input type="checkbox"/> White	295 mm	1195 mm		€ 129.95
100124	<input type="checkbox"/> White	620 mm	620 mm		€ 124.95



Accessories

930672	Rope suspension for 620x620/300x1200mm Panel		€ 22.95
930674	Safety rope		€ 4.95
862258	QUICK, CC, 1,050 mA, 25-40 V, 45 W		€ 46.95
862193	BASIC, DIM, Multi CC, IE-45HD		€ 69.95

Accessories for 100124

930665	Built-up frame for 620x620mm Panel		€ 59.95
930670	Recessed frame for 620x620mm Backlit Panel		€ 59.95

Accessories for 100138

930666	Built-up frame for 300x1200mm Panel		€ 69.95
930671	Recessed frame for 300x1200mm Backlit Panel		€ 69.95



STANDARD SANO

- BEG-eligible
- for insertion in grid ceilings
- Installation in surface-mounted and recessed frames possible
- Suspension possible
- Refurbishment solution for T5/T8 louvre luminaires
- Can be individually combined with power supply unit [excl.]

Housing	Aluminium, Polycarbonate	Power Supply Unit incl.	No
Colour Temperature	4000 K	Light Beam Angle	120 Degree
Luminous Flux	4900 lm	Control	Dimmable via optional power supply unit
Length	1495 mm	Colour Rendering Index (Ra)	90
Width	295 mm	Rated Current	1050 mA
Height	10 mm	UGR	22
Power	33 W		
Rated Input Voltage	35-40 V/DC		

Article	Housing Color		Price
100158	<input type="checkbox"/> White	NW	€ 169.95

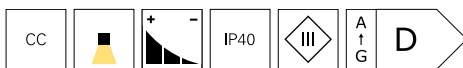

Accessories

930795	Built-up frame for 1500x300mm Panel		€ 79.95
930796	Recessed frame for 1500x300mm Panel		€ 69.95
930673	Rope suspension for 600x1200mm Panel		€ 32.95
930674	Safety rope		€ 4.95
862258	QUICK, CC, 1,050 mA, 25-40 V, 45 W		€ 46.95



OFFICE FLEX

- For insertion into grid ceilings
- Mounting in surface-mounted and recessed frames possible
- Suspension possible
- Suitable for offices, lounges, path areas
- Light colour adjustable in three stages
- suitable for VDU workstations in accordance with EN 12464-1 BAP65
- microprismatic surface structure

Housing	Aluminium	Control	Leading-edge dimmer, Trailing-edge dimmer
Colour Temperature	3000/4000/5700 K	Colour Rendering Index (Ra)	90
Height	10 mm	IK Protection Class	IK08
Power	40 W	UGR	19
Rated Input Voltage	220-240 V/AC		
Power Supply Unit incl.	Yes		
Light Beam Angle	100 Degree		

Article	Housing Color		Luminous Flux	Length	Width	Price
100078	<input type="checkbox"/> White	<input type="checkbox"/> WW <input type="checkbox"/> NW <input type="checkbox"/> CW	3300 lm	620 mm	620 mm	€ 179.95
100079	<input type="checkbox"/> White	<input type="checkbox"/> WW <input type="checkbox"/> NW <input type="checkbox"/> CW	3500 lm	1195 mm	295 mm	€ 219.95

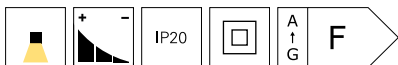

Accessories

862193 BASIC, DIM, Multi CC, IE-45HD  € 69.95

Accessories for 100078

930665 Built-up frame for 620x620mm Panel  € 59.95

930670 Recessed frame for 620x620mm Backlit Panel  € 59.95

Accessories for 100079

930666 Built-up frame for 300x1200mm Panel  € 69.95

930671 Recessed frame for 300x1200mm Backlit Panel  € 69.95



HCL



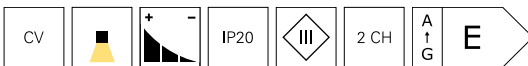

- For insertion in grid ceilings
- Installation in surface-mounted and recessed frames possible
- Suitable for 24 V HCL control units
- Suitable for event rooms / recreation rooms, path areas
- low housing depth

Housing	Aluminium	Rated Input Voltage	24 V/DC
Colour Temperature	3000-5500 K	Power Supply Unit incl.	No
Luminous Flux	3551 lm	Light Beam Angle	120 Degree
Length	620 mm	Control	Dimmable via optional controller
Width	620 mm	Colour Rendering Index (Ra)	80
Height	10 mm		
Power	49.5 W		

Article	Housing Color	Colour Temperature	Price
100032	<input type="checkbox"/> White	<input checked="" type="checkbox"/> WW <input checked="" type="checkbox"/> CW 3000-5500 K	€ 159.95



Accessories

930665	Built-up frame for 620x620mm Panel		€ 59.95
930670	Recessed frame for 620x620mm Backlit Panel		€ 59.95
862122	FLAT, CV, UT24V/50W		€ 52.95
862166	BASIC, CV, Q8H-24-100W		€ 96.95
843501	RF-smart, Starter-Set LED Single/CCT, 12-48V, 20A remote control incl.		€ 99.95



STANDARD RGB CCT

- For insertion into grid ceilings
- Installation in surface-mounted and recessed frames possible
- Suitable for event rooms, recreation rooms, path areas
- suitable for 24 V colour and HCL control systems

Housing	Aluminium	Power Supply Unit incl.	No
Colour Temperature	2700-6500 K	Control	Dimmable via optional controller
Height	12.5 mm	Colour Rendering Index (Ra)	90
Power	94 W		
Rated Input Voltage	24 V/DC		

Article		Length	Width	Price
100160		595 mm	595 mm	€ 209.95
100159		620 mm	620 mm	€ 209.95



Accessories for **100159**

930665 Built-up frame for 620x620mm Panel  **€ 59.95**

930668 Recessed frame for 620x620mm Panel  **€ 57.95**

Accessories for **100160**

930664 Built-up frame for 595x595mm Panel  **€ 54.95**

930667 Recessed frame for 595x595mm Panel  **€ 52.95**



Onlineshop

You can find more information about the products in the onlineshop: Detailed images, videos, project reports, LDT files, EPREL data sheets and more.



STANDARD RGBW

- For insertion in grid ceilings
- Installation in surface-mounted and recessed frames possible
- Powerful and intense colours including pastel shades
- Suitable for 24 V colour controls
- suitable for event rooms, recreation rooms, path areas

Housing	Aluminium	Light Beam Angle	110 Degree
Height	11 mm	Control	Dimmable via optional controller
Power	94 W	Colour Rendering Index (Ra)	90
Rated Input Voltage	24 V/DC		
Power Supply Unit incl.	No		

Article	Housing Color	Colour Temperature	Luminous Flux	Length	Width	Price
100156	<input type="checkbox"/> White	3000 K	4000 lm	595 mm	595 mm	€ 184.95
100152	<input type="checkbox"/> White	3000 K	4000 lm	620 mm	620 mm	€ 189.95
100157	<input type="checkbox"/> White	4000 K	4200 lm	595 mm	595 mm	€ 184.95
100153	<input type="checkbox"/> White	4000 K	4200 lm	620 mm	620 mm	€ 189.95

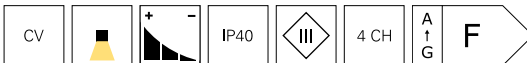

Accessories

862166	BASIC, CV, Q8H-24-100W		€ 96.95
872091	IP, CV, V6-320-24		€ 219.95
843502	RF-smart, Starter-Set RGB/W/CCT, 12-48V, 20A remote control, IP20 incl.		€ 99.95
843037	Bluetooth controller CBU-PWM4		€ 179.95
843279	MULTI-LED-Dimmer 1-4 CH, DMX/AUTO/MAN, 12-48V, 20A		€ 114.95

Accessories for 100152, 100153

930665	Built-up frame for 620x620mm Panel		€ 59.95
930668	Recessed frame for 620x620mm Panel		€ 57.95

Accessories for 100156, 100157

930664	Built-up frame for 595x595mm Panel		€ 54.95
930667	Recessed frame for 595x595mm Panel		€ 52.95

surface mounted wall lights



page 172



page 174



page 176



page 178



page 180



page 181



page 182





UNI II











- „Glow“ effect on the reflector ring
- Can be rotated and swivelled
- Can be customised with a wide range of accessories

Housing	Aluminium	Power	12 W
Colour Temperature	3000 K	Rated Input Voltage	220-240 V/AC
Luminous Flux	670 lm	Power Supply Unit incl.	Yes
Length	120 mm	Light Beam Angle	36 Degree
Width	95 mm	Swivelling Angle	90 Degree
Height	205 mm	Control	Leading-edge dimmer, Trailing-edge dimmer
Ø	100 mm	Colour Rendering Index (Ra)	90
Base Length	120 mm		
Base Width	43 mm		
Base Height	205 mm		

Article	Housing Color		Price
341215	<input type="checkbox"/> White		€ 179.95
341232	<input checked="" type="checkbox"/> Black		€ 179.95



Accessories

930339	Reflector ring black for series Uni II		€ 10.95
930340	Reflector ring gold for series Uni II		€ 10.95
930341	Reflector ring chrome for series Uni II		€ 10.95
930334	Cover back white for series Uni II		€ 3.55
930335	Cover back black for series Uni II		€ 2.95
930336	Cover heatsink white for series Uni II		€ 3.55
930337	Cover heatsink black for series Uni II		€ 7.95
930306	Reflector 48° for series Klara / Nihal Mini / Rigel Mini / Uni II		€ 8.95
930307	Honeycomb filter for series Klara / Nihal Mini / Rigel Mini / Uni II		€ 8.95
930308	Spread lense for series Klara / Nihal Mini / Rigel Mini / Uni II		€ 8.95
Accessories			
930309	Softening lense for series Klara / Nihal Mini / Rigel Mini / Uni II		€ 8.95
930310	Linear spread lense for series Klara / Nihal Mini / Rigel Mini / Uni II		€ 8.95



page 70



page 72



page 74



page 140



page 366



Technical data sheet

New in the onlineshop: The technical data sheets offer even more information: Light and energy data, light distribution curves, dimensional drawings and more.



ACAMAR

Small, fine, elegant and discreet - The ACAMAR is a light manufactured from high-quality aluminium. The colour reproduction value is over 90, which means high colour authenticity. The design is chic and interesting thanks to the rounding on one side. You can mount the light with the rounding upwards or downwards, depending on your preference. The white paint inside accentuates the warm white light and ensures pleasant scattering upwards and downwards. The outside is highly polished for an incredible shine.



ACAMAR

Housing	Aluminium	Power	6.9 W
Colour Temperature	3000 K	Rated Input Voltage	220-240 V/AC
Length	170 mm	Power Supply Unit incl.	Yes
Width	100 mm	Light Beam Angle	105 Degree
Height	80 mm	Control	Leading-edge dimmer, Trailing-edge dimmer
Base Length	120 mm	Colour Rendering Index (Ra)	90
Base Width	60 mm		
Base Height	33 mm		

Article	Housing Color		Luminous Flux	Price
341196	■ Black	ww	250 lm	€ 149.95
341194	□ White	ww	390 lm	€ 149.95
341195	▒ Silver, White	ww	400 lm	€ 149.95



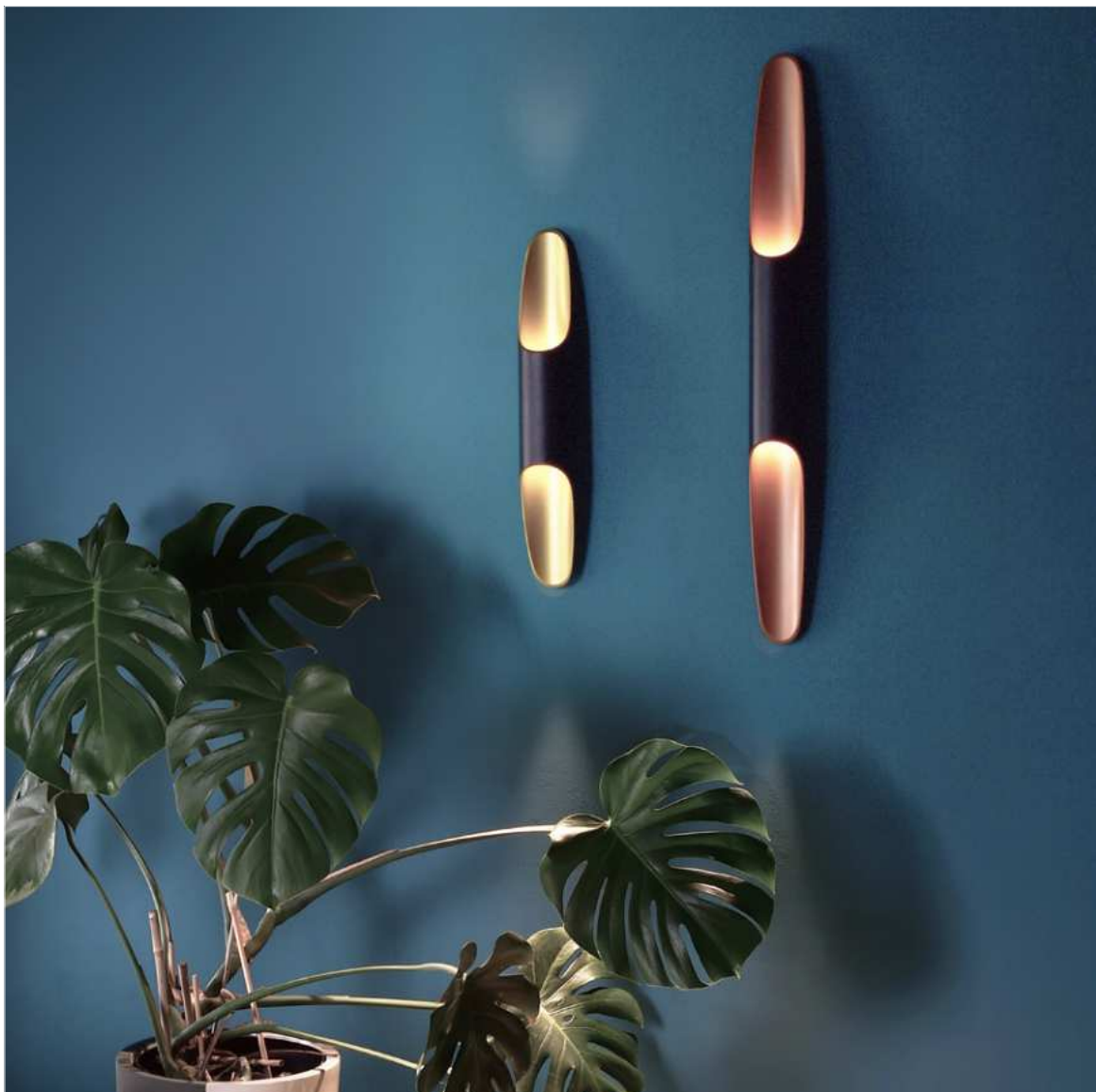

APODIS

The elegant APODIS wall light captivates with its high-quality aluminium housing with compact base and a fine two-colour coating in black and gold. The Apodis emits powerful warm white light both upwards and downwards via the double light output. The light can be dimmed flexibly using leading/trailing phase angles.





APODIS

•Dimmable

Housing	Aluminium	Rated Input Voltage	220-240 V/AC
Colour Temperature	3000 K	Power Supply Unit incl.	Yes
Length	76 mm	Control	Leading-edge dimmer, Trailing-edge dimmer
Width	61 mm	Colour Rendering Index (Ra)	80
Base Length	60 mm		
Base Width	18 mm		
Base Height	100 mm		

Article	Housing Color		Luminous Flux	Height	Power	Light Beam Angle	Price
341200	■ Gold, Black	ww	350 lm	500 mm	10.8 W	40 Degree	€ 219.95
341201	■ Rosé, Black	ww	350 lm	500 mm	10.8 W	40 Degree	€ 219.95
341202	■ Gold, Black	ww	450 lm	800 mm	14.7 W	30 Degree	€ 269.95
341203	■ Rosé, Black	ww	450 lm	800 mm	14.7 W	30 Degree	€ 269.95





CUBE

Little cube, big effect: The cube emits its light up and down in equal measure, drawing the eye to spacial elements and bringing structure. The compact cube made from concrete [available in the colour tones beige, grey and anthracite] with its subdued design has the essentials in focus, assuming a back seat presence.





CUBE

- Interchangeable light source
- Wide range of colour variants in concrete / plaster
- paintable [white version only]

Length	115 mm	Max. Power	1x max. 25 W
Width	115 mm	Rated Input Voltage	220-240 V/AC
Height	115 mm	Control	Dimmable via optional light source
Base Length	57 mm	Colour of Light Output	White
Base Width	57 mm		
Base Height	63 mm		

Article	Housing Color	Housing	Paintable	Price
341183	Grey	Concrete		€ 69.95
341184	Grey	Concrete		€ 69.95
341185	Beige	Concrete		€ 69.95
341250	Black	Plaster		€ 69.95
341249	White	Plaster	Yes	€ 69.95



Light sources

For all lights and bases:
You can find the right light sources in the »Light sources« section.



CAN IP20

- customised lighting solution thanks to replaceable light source
- can be combined with the product family of the CAN series

Housing	Aluminium	Max. Power	1x max. 7.5 W
Length	72 mm	Rated Input Voltage	220-240 V/AC
Height	125 mm	Control	Dimmable via optional light source
Ø	60 mm		

Article	Housing Color	Price
341341	<input type="checkbox"/> White	€ 44.95
341342	<input checked="" type="checkbox"/> Black	€ 44.95



page 51

page 88

page 90

page 91

page 364



Light sources

For all lights and bases:

You can find the right light sources in the »Light sources« section.



CAN UP & DOWN IP20

- customised lighting solution thanks to replaceable light source
- can be combined with the product family of the CAN series

Housing	Aluminium	Max. Power	2x max. 7.5 W
Length	72 mm	Rated Input Voltage	220-240 V/AC
Height	230 mm	Control	Dimmable via optional light source
Ø	60 mm		

Article	Housing Color	Price
341343	<input type="checkbox"/> White	€ 54.95
341344	<input checked="" type="checkbox"/> Black	€ 54.95



page 51



page 88



page 90



page 91



page 364



Light sources

For all lights and bases:

You can find the right light sources in the »Light sources« section.



MADERA

The MADERA series is made from premium European oak and captivates with its modern design and mix of materials in private living areas, hotels, restaurants and many more places too. The elegant MADERA lights distribute their powerful warm white light in every room and also cut an excellent figure providing functional and high-quality lighting at reception desks and elsewhere.



page 94



page 94



page 202





page 203



MADERA

- Manufactured in Europe from quality class A oak
- FSC-certified oak raw material from sustainable forestry

Housing	Wood, Steel	Base Height	30 mm
Colour Temperature	3000 K	Power	9 W
Luminous Flux	560 lm	Rated Input Voltage	200-240 V/AC
Length	450 mm	Power Supply Unit incl.	Yes
Width	60 mm	Light Beam Angle	120 Degree
Height	130 mm	Colour Rendering Index (Ra)	80
Base Length	250 mm		
Base Width	60 mm		

Article	Housing Color		Price
341248	 Brown, Black		€ 279.95

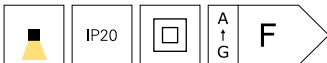

built in wall lights



□
page 186



□ □ ■
page 188



□ □ ■
page 189







ALWAID II

The ALWAID 2 recessed wall light fits into any 68 mm standard or deep switch box thanks to its compact design. Furthermore, it does not require an additional power supply. The variety of covers allows you to find a style that suits your space and illuminates your surroundings with beautiful indirect light. The article includes the base only; covers are not included in the scope of delivery.





ALWAID II

- 230 V direct connection
- Through-wiring possible
- Can be dimmed using leading-edge phase dimmers or trailing-edge phase dimmers
- Suitable for 68 mm standard and deep switch boxes

Housing	Aluminium	Light Beam Angle	100 Degree
Height	39.9 mm	Cut Out Ø	61.5 mm
Ø	71.2 mm	Control	Trailing-edge dimmer
Power	4.8 W	Colour Rendering Index (Ra)	90
Rated Input Voltage	220-240 V/AC		
Power Supply Unit incl.	Yes		
Installation Depth	39.9 mm		

Article	Housing Color	Colour Temperature	Luminous Flux	Price
563009	<input type="checkbox"/> White	ww 2700 K	185 lm	€ 79.95
563010	<input type="checkbox"/> White	ww 3000 K	212 lm	€ 79.95
563011	<input type="checkbox"/> White	nw 4000 K	225 lm	€ 79.95



Lighting design

Interested in our lighting design service?
Your contact person will be happy to answer any questions you may have.

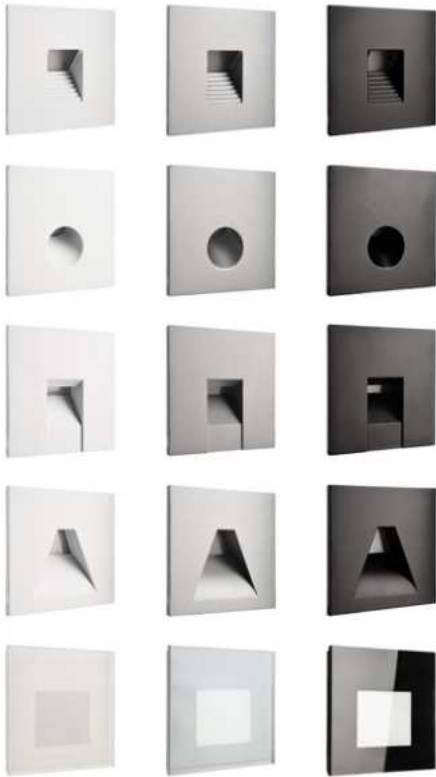

ALWAID II - ANGULAR COVER

- Various shapes and colours for every application
- Ideal for staircase or night lighting
- Glass covers for glare-free and soft light
- Aluminium covers for different light beams

Article	Housing Color	Housing	light output	Length	Width	Height	Price
930485	White	Aluminium	step	75 mm	75 mm	19 mm	€ 14.95
930486	Aluminum	Aluminium	step	75 mm	75 mm	19 mm	€ 14.95
930487	Black	Aluminium	step	75 mm	75 mm	19 mm	€ 14.95
930491	White	Aluminium	round	75 mm	75 mm	19.1 mm	€ 14.95
930492	Aluminum	Aluminium	round	75 mm	75 mm	19.1 mm	€ 14.95
930493	Black	Aluminium	round	75 mm	75 mm	19.1 mm	€ 14.95
930482	White	Aluminium	square	75 mm	75 mm	19.8 mm	€ 14.95
930483	Aluminum	Aluminium	square	75 mm	75 mm	19.8 mm	€ 14.95
930484	Black	Aluminium	square	75 mm	75 mm	19.8 mm	€ 14.95
930488	White	Aluminium	trapeze	75 mm	75 mm	19.8 mm	€ 14.95
930489	Aluminum	Aluminium	trapeze	75 mm	75 mm	19.8 mm	€ 14.95
930490	Black	Aluminium	trapeze	75 mm	75 mm	19.8 mm	€ 14.95
930480	White	Glass	milky	78.2 mm	78.2 mm	22.9 mm	€ 19.95
930842	Black	Glass	milky	78.2 mm	78.2 mm	22.9 mm	€ 19.95
930860	Aluminum	Glass	milky	78.2 mm	78.2 mm	22.9 mm	€ 23.74

IP20



ALWAID II - ROUND COVER

- Various shapes and colours for every application
- Ideal for staircase or night lighting
- Glass covers for glare-free and soft light
- Aluminium covers for different light beams

Article	Housing Color	Housing	light output	Height	Ø	Price
930497	□ White	Aluminium	step	19 mm	75 mm	€ 14.95
930498	□ Aluminum	Aluminium	step	19 mm	75 mm	€ 14.95
930499	■ Black	Aluminium	step	19 mm	75 mm	€ 14.95
930500	□ White	Aluminium	square	19.8 mm	75 mm	€ 14.95
930501	□ Aluminum	Aluminium	square	19.8 mm	75 mm	€ 14.95
930502	■ Black	Aluminium	square	19.8 mm	75 mm	€ 14.95
930503	□ White	Aluminium	trapeze	19.8 mm	75 mm	€ 14.95
930504	□ Aluminum	Aluminium	trapeze	19.8 mm	75 mm	€ 14.95
930505	■ Black	Aluminium	trapeze	19.8 mm	75 mm	€ 14.95
930494	□ White	Aluminium	round	20.4 mm	74.9 mm	€ 14.95
930495	□ Aluminum	Aluminium	round	20.4 mm	74.9 mm	€ 14.95
930496	■ Black	Aluminium	round	20.4 mm	74.9 mm	€ 14.95
930481	□ White	Glass	milky	22.8 mm	78 mm	€ 19.95
930843	■ Black	Glass	milky	22.8 mm	78 mm	€ 19.95
930861	□ Aluminum	Glass	milky	22.8 mm	78 mm	€ 19.95

IP20

reading lights



page 192



page 193



page 194



page 195





BRAHE ROUND

- Can be rotated and swivelled
- Direct and indirect lighting can be switched on separately
- Ideal as a reading light

Housing	Aluminium	Power Supply Unit incl.	Yes
Colour Temperature	3000 K	Light Beam Angle	25 Degree
Height	110 mm	Swivelling Angle	360 Degree
Ø	150 mm	Colour Rendering Index (Ra)	80
Power	8.5 W		
Rated Input Voltage	220-240 V/AC		

Article	Housing Color		Luminous Flux	Price
341243	■ Black	ww	395 lm	€ 99.95
341242	□ White	ww	490 lm	€ 99.95

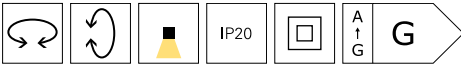

page 198

page 199



BRAHE ANGULAR

- High-quality, flexible gooseneck
- Gooseneck with silicone coating for easy cleaning
- Individually adjustable via flexible gooseneck
- Ideal as a reading light

Housing	Aluminium	Power	3.3 W
Colour Temperature	3000 K	Rated Input Voltage	100-240 V/AC
Length	310 mm	Power Supply Unit incl.	Yes
Height	80 mm	Light Beam Angle	25 Degree
Ø	25 mm	Swivelling Angle	360 Degree
Base Length	80 mm	Colour Rendering Index (Ra)	80
Base Width	80 mm		
Base Height	25 mm		

Article	Housing Color		Luminous Flux	Price
341237	■ Black	ww	165 lm	€ 64.95
341236	□ White	ww	175 lm	€ 64.95

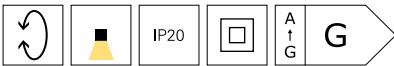

page 198

page 199



CAN TILT ANGULAR

- Customised lighting solution thanks to replaceable light source
- Can be combined with the extensive product family of the CAN series
- Charging option via USB-C / USB-A [only item no. 341339 and 341340]

Housing	Aluminium	Max. Power	1x max. 7.5 W
Length	102 mm	Rated Input Voltage	220-240 V/AC
Height	105 mm	Control	Dimmable via optional light source
Ø	60 mm	Rotation Angle	355 Degree
Base Width	100 mm	Swivelling Angle	90 Degree
Base Height	100 mm		

Article	Housing Color	Charging option	Price
341338	■ Black	no	€ 49.95
341337	□ White	no	€ 49.95
341339	□ White	yes	€ 69.95
341340	■ Black	yes	€ 69.95



page 51

page 88

page 90

page 91

page 364



Light sources

For all lights and bases:

You can find the right light sources in the »Light sources« section.



CANTILT ROUND

- Customised lighting solution thanks to replaceable light source
- Can be combined with the extensive product family of the CAN series
- Charging option via USB-C / USB-A [only item no. 341335 and 341336]

Housing	Aluminium	Rated Input Voltage	220-240 V/AC
Length	102 mm	Control	Dimmable via optional light source
Height	105 mm	Rotation Angle	355 Degree
Ø	60 mm	Swivelling Angle	90 Degree
Base Ø	100 mm		
Max. Power	1x max. 7.5 W		

Article	Housing Color	Charging option	Price
341333	<input type="checkbox"/> White	no	€ 49.95
341334	<input checked="" type="checkbox"/> Black	no	€ 49.95
341335	<input type="checkbox"/> White	yes	€ 69.95
341336	<input checked="" type="checkbox"/> Black	yes	€ 69.95



page 51 page 88 page 90 page 91 page 364



Light sources

For all lights and bases:
You can find the right light sources in the »Light sources« section.

table and floor lights



□ ■
page 198



□ ■
page 199



■ □ □
page 200



■ ■
page 202



■ ■
page 203





BRAHE

- Can be rotated and swivelled
- Direct and indirect lighting can be switched on separately

Housing	Aluminium	Power Supply Unit incl.	Yes
Colour Temperature	3000 K	Light Beam Angle	25 Degree
Height	455 mm	Swivelling Angle	90 Degree
Ø	150 mm	Primary Connection End	Power plug IP20
Power	8.5 W	Colour Rendering Index	80 (Ra)
Rated Input Voltage	220-240 V/AC		

Article	Housing Color		Luminous Flux	Price
346016	■ Black	ww	370 lm	€ 149.95
346015	□ White	ww	470 lm	€ 149.95

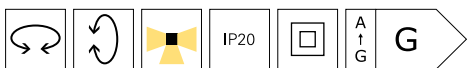

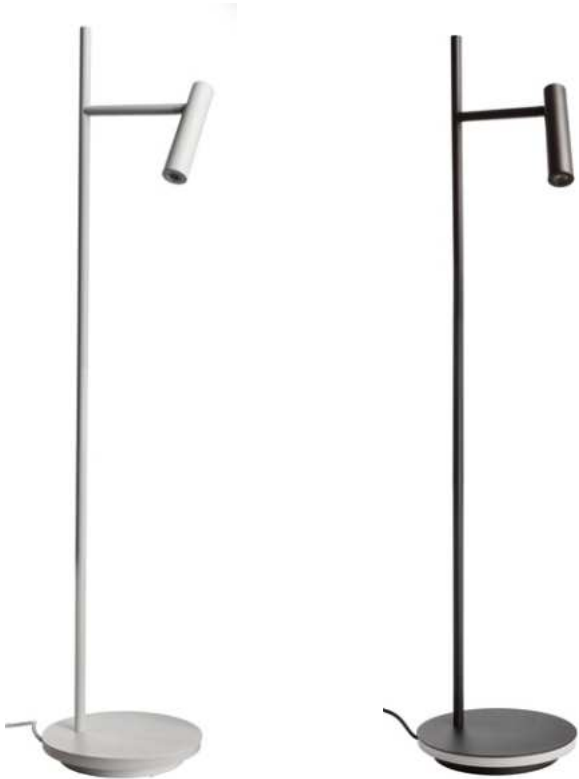

BRAHE

- Can be rotated and swivelled
- Direct and indirect lighting can be switched on separately

Housing	Aluminium	Power Supply Unit incl.	Yes
Colour Temperature	3000 K	Light Beam Angle	25 Degree
Luminous Flux	530 lm	Swivelling Angle	90 Degree
Height	1387 mm	Primary Connection End	Power plug IP20
Ø	305 mm	Colour Rendering Index	80 (Ra)
Power Selectable	3 W, 8 W		
Rated Input Voltage	220-240 V/AC		

Article	Housing Color		Price
343025	<input type="checkbox"/> White		€ 249.95
343026	<input checked="" type="checkbox"/> Black		€ 249.95





ADHARA

Classic design interpreted in a modern way - the ADHARA made from aluminium captivates with its classic lines, ultra-modern materials and high degree of flexibility. The ADHARA can be optimally adjusted to any situation via its two or three joints. Its powerful LED module delivers 950 lumens and can also be dimmed thanks to a touch sensor. Whether for the boss's office or for a child's desk, the ADHARA looks great anywhere.



ADHARA

- Can be rotated and swivelled via joints
- Dimmable in three stages using touch sensor

Housing	Aluminium	Rated Input Voltage	100-240 V/AC
Colour Temperature	3000 K	Power Supply Unit incl.	Yes
Luminous Flux	950 lm	Light Beam Angle	120 Degree
Length	498 mm	Swivelling Angle	180 Degree
Height	480 mm	Primary Cable Length	1.6 m
Ø	150 mm	Primary Connection End	Power plug
Base Height	21.5 mm	Colour Rendering Index (Ra)	80
Base Ø	180 mm		
Power	12 W		

Article	Housing Color		Price
346026	■ Black	ww	€ 189.95
346027	□ White	ww	€ 189.95
346028	■ Silver	ww	€ 189.95





MADERA

- Manufactured in Europe from quality class A oak
- FSC-certified oak raw material
- Infinitely dimmable using touch sensor

Housing	Wood, Steel	Base Height	6 mm
Colour Temperature	3000 K	Power	7 W
Luminous Flux	560 lm	Rated Input Voltage	220-240 V/AC
Length	40 mm	Power Supply Unit incl.	Yes
Width	60 mm	Light Beam Angle	120 Degree
Height	510 mm	Primary Connection End	Power plug IP20
Base Length	160 mm	Colour Rendering Index	80
Base Width	130 mm	(Ra)	

Article	Housing Color		Price
346044	Brown, Black	WW	€ 299.95





MADERA

- Manufactured in Europe from quality class A oak
- FSC-certified oak raw material
- Infinitely dimmable using touch sensor

Housing	Wood, Steel	Base Height	6 mm
Colour Temperature	3000 K	Power	17 W
Luminous Flux	1592 lm	Rated Input Voltage	220-240 V/AC
Length	40 mm	Power Supply Unit incl.	Yes
Width	60 mm	Light Beam Angle	120 Degree
Height	1400 mm	Primary Connection End	Power plug IP20
Base Length	250 mm	Colour Rendering Index (Ra)	80
Base Width	180 mm		

Article	Housing Color		Price
343031	Brown, Black		€ 549.95



showcase lights



page 207



page 208



page 210



page 211



HERCULIS

Small helpers, big effect. With HERCULIS display luminaires in high-quality aluminium housings, you can reach all corners of a showcase. The luminaire head with its 40° beam angle can be freely rotated and swivelled in any direction. In addition, the intelligent cable routing and the ready-to-plug-in system allow easy surface and recessed mounting in showcases, counters, sales areas or in the living room.





HERCULIS MAGNETIC

- High output with compact design
- Magnetic light head
- Individual alignment thanks to ball head
- for surface mounting
- ready-to-plug-in system

Housing	Aluminium	Rated Current	350 mA
Height	42.2 mm	Power Supply Unit incl.	No
Ø	31 mm	Light Beam Angle	40 Degree
Base Height	5 mm	Swivelling Angle	180 Degree
Base Ø	31 mm	Colour Rendering Index (Ra)	90
Power	1 W		
Rated Input Voltage	3 V/DC		

Article	Housing Color	Colour Temperature	Luminous Flux	Price
688025	Black	3000 K	100 lm	€ 57.95
688026	Silver	3000 K	100 lm	€ 57.95
688027	Black	4000 K	105 lm	€ 57.95
688028	Silver	4000 K	105 lm	€ 57.95



Accessories

- 930594** LED-power supply incl. 3 times distributor for Herculis
- 930592** LED-power supply incl. 6 times distributor for Herculis



€ 32.95

€ 39.95



Technical data sheet

New in the onlineshop: The technical data sheets offer even more information: Light and energy data, light distribution curves, dimensional drawings and more.



HERCULIS SINGLE

- High performance with compact design
- Rotating and swivelling head
- for recessed and surface mounting thanks to intelligent cable routing
- Ready-to-plug-in system
- Available in two sizes

Housing	Aluminium	Rated Current	350 mA
Luminous Flux	100 lm	Power Supply Unit incl.	No
Ø	39.2 mm	Light Beam Angle	30 Degree
Base Height	4.5 mm	Swivelling Angle	350 Degree
Base Ø	39.2 mm	Colour Rendering Index (Ra)	90
Power	1 W		
Rated Input Voltage	3 V/DC		

Article	Housing Color	Colour Temperature	Height	Price
688029	Black	3000 K	150 mm	€ 79.95
688030	Silver	3000 K	150 mm	€ 79.95
688034	Black	3000 K	250 mm	€ 79.95
688035	Silver	3000 K	250 mm	€ 79.95
688031	Black	4000 K	150 mm	€ 79.95
688033	Silver	4000 K	150 mm	€ 79.95
688036	Black	4000 K	250 mm	€ 79.95
688037	Silver	4000 K	250 mm	€ 79.95



Accessories

- 930594** LED-power supply incl. 3 times distributor for Herculis
- 930592** LED-power supply incl. 6 times distributor for Herculis



€ 32.95
€ 39.95





HERCULIS DOUBLE



- High performance with compact design
- Rotating and swivelling heads
- for recessed and surface mounting thanks to intelligent cable routing
- Ready-to-plug-in system

Housing	Aluminium	Rated Current	350 mA
Height	200 mm	Power Supply Unit incl.	No
Ø	39.2 mm	Light Beam Angle	30 Degree
Base Height	4.5 mm	Swivelling Angle	350 Degree
Base Ø	39.2 mm	Colour Rendering Index	90
Power	2 W	(Ra)	
Rated Input Voltage	6 V/DC		

Article	Housing Color	Colour Temperature	Luminous Flux	Price
688038	Black	3000 K	185 lm	€ 115.95
688039	Silver	3000 K	185 lm	€ 115.95
688040	Black	4000 K	195 lm	€ 115.95
688041	Silver	4000 K	195 lm	€ 115.95



Accessories

- 930594** LED-power supply incl. 3 times distributor for Herculis  € 32.95
- 930592** LED-power supply incl. 6 times distributor for Herculis  € 39.95



HERCULIS TRIPLE

- High performance with compact design
- Rotating and swivelling heads
- for recessed and surface mounting thanks to intelligent cable routing
- Ready-to-plug-in system

Housing	Aluminium	Rated Current	350 mA
Height	250 mm	Power Supply Unit incl.	No
Ø	39.2 mm	Light Beam Angle	30 Degree
Base Height	4.5 mm	Swivelling Angle	350 Degree
Base Ø	39.2 mm	Colour Rendering Index (Ra)	90
Power	3 W		
Rated Input Voltage	9 V/DC		

Article	Housing Color	Colour Temperature	Luminous Flux	Price
688042	■ Black	WW 3000 K	263 lm	€ 135.95
688043	■ Silver	WW 3000 K	294 lm	€ 135.95
688044	■ Black	NW 4000 K	290 lm	€ 135.95
688045	■ Silver	NW 4000 K	290 lm	€ 135.95



Accessories

930594 LED-power supply incl. 3 times distributor for Herculis



€ 32.95

930592 LED-power supply incl. 6 times distributor for Herculis



€ 39.95

office lights



■ □ ■
page 214



■ □ ■
page 216



■ □ ■
page 218



■ □ □
page 220

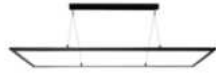

■ □ □
page 222



■
page 224



□ □ ■
page 232



□ □ ■
page 233



□ □ ■
page 234



□ □ ■
page 235





D PROFESSION DOWN

Due to their flexible control options, you can use the D PROFESSION pendant lamps both in private and in commercial applications. In private settings, the dimmable Down version creates an exceptional atmosphere of illumination that blends perfectly with its modern design.





D PROFESSION DOWN

- High light output
- Very low glare value
- Dimmable

Housing	Aluminium	Pendulum Length	3000 mm
Colour Temperature	4000 K	Base Length	560 mm
Luminous Flux	3165 lm	Base Width	65 mm
Power	28 W	Base Height	38 mm
Rated Input Voltage	200-240 V/AC	Power Supply Unit incl.	Yes
Length	1177.4 mm	Light Beam Angle	24 Degree
Width	53 mm	Colour Rendering Index (Ra)	80
Height	53 mm		

Article	Housing Color		Control	Price
620102	Black		1-10 V	€ 339.95
620106	White		1-10 V	€ 339.95
620109	Silver		1-10 V	€ 339.95
620057	Black		DALI 1.0 / DT6	€ 359.95
620105	White		DALI 1.0 / DT6	€ 359.95
620108	Silver		DALI 1.0 / DT6	€ 359.95
620103	Black		Leading-edge / Trailing-edge dimmer	€ 329.95
620107	White		Leading-edge / Trailing-edge dimmer	€ 329.95
620110	Silver		Leading-edge / Trailing-edge dimmer	€ 329.95





D PROFESSION UP & DOWN

Due to their flexible control options, you can use the D PROFESSION pendant lamps both in private and in commercial applications. The Up & Down version emits its light in two directions. Whilst the LEDs directed upwards generate pleasant, indirect room lighting, the LEDs directed downwards ensure defined, powerful and UGR-compliant office and work lighting for desks and more.





D PROFESSION UP & DOWN

- High light output
- Low glare value
- Dimmable
- Including uplight for indirect light

Housing	Aluminium	Base Length	560 mm
Colour Temperature	4000 K	Base Width	65 mm
Luminous Flux	7180 lm	Base Height	38 mm
Power	60 W	Power Supply Unit incl.	Yes
Rated Input Voltage	200-240 V/AC	Light Beam Angle	110 Degree
Length	1177.4 mm	Light Beam Angle 2	24 Degree
Width	53 mm	Colour Rendering Index (Ra)	80
Height	53 mm		
Pendulum Length	3000 mm		

Article	Housing Color		Control	Price
620113	Silver		1-10 V	€ 399.95
620114	White		1-10 V	€ 399.95
620115	Black		1-10 V	€ 399.95
620116	Silver		DALI 1.0 / DT6	€ 429.95
620117	White		DALI 1.0 / DT6	€ 429.95
620118	Black		DALI 1.0 / DT6	€ 429.95
620104	Silver		Leading-edge / Trailing-edge dimmer	€ 399.95
620111	White		Leading-edge / Trailing-edge dimmer	€ 399.95
620112	Black		Leading-edge / Trailing-edge dimmer	€ 399.95





OFFICE THREE

The pendant lamp is an appropriate addition to the OFFICE THREE MOTION standing lamp. As the glare value is under 10, this sophisticated light can be thought of as being almost entirely glare-free. The LEDs directed upwards create room lighting, whilst the LEDs directed downwards emit clearly defined and powerful light onto the work area.



OFFICE THREE

- Very low UGR value
- High luminous flux
- Controlled using DALI 2.0
- Including uplight for indirect light

Housing	Aluminium	Base Length	600 mm
Colour Temperature	4000 K	Base Width	56.5 mm
Luminous Flux	7000 lm	Base Height	35 mm
Power	60 W	Power Supply Unit incl.	Yes
Rated Input Voltage	200-240 V/AC	Light Beam Angle	115 Degree
Length	1179 mm	Light Beam Angle 2	55 Degree
Width	64 mm	Control	DALI 2 / DT6
Height	35 mm	Colour Rendering Index (Ra)	80
Pendulum Length	2500 mm		

Article	Housing Color		Price
342146	Silver	NW	€ 599.95
342147	White	NW	€ 599.95



Lighting design

Interested in our lighting design service?

Your contact person will be happy to answer any questions you may have.



LED PANEL TRANSPARENT ROUND

This pendant lamp is distinct for its transparent luminous element. The surface is almost completely see-through when switched off. When the light is switched on, the pane distributes the light almost entirely without glare. This pendant lamp is fully office-compatible with a glare value [UGR] of under 19. Bright, efficient and with a sophisticated design, this light stands out in any type of office environment.





LED PANEL TRANSPARENT ROUND

·Very low glare value

·Transparent luminous element

Housing	Aluminium	Power Supply Unit incl.	Yes
Rated Input Voltage	220-240 V/AC	Light Beam Angle	150 Degree
Height	12.5 mm	Control	Leading-edge dimmer, Trailing-edge dimmer
Ø	580 mm	Colour Rendering Index (Ra)	80
Pendulum Length	1500 mm		
Base Ø	250 mm		
Base Height	45 mm		

Article	Housing Color	Colour Temperature	Luminous Flux	Power	Price
342089	■ Black	ww 3000 K	6612 lm	53.3 W	€ 379.95
342090	□ Aluminum	ww 3000 K	6612 lm	53.3 W	€ 379.95
342091	□ White	ww 3000 K	6612 lm	53.3 W	€ 379.95
342092	■ Black	nw 4000 K	6776 lm	53.7 W	€ 379.95
342093	□ Aluminum	nw 4000 K	6776 lm	53.7 W	€ 379.95
342094	□ White	nw 4000 K	6776 lm	53.7 W	€ 379.95



Accessories

843340 DALI, Triac-Dimmer, 100-240V, 400W, IP20



€ 74.95



Technical data sheet

New in the onlineshop: The technical data sheets offer even more information: Light and energy data, light distribution curves, dimensional drawings and more.



LED PANEL TRANSPARENT ANGULAR

The LED pendant lamp has transparent glass for direct and indirect light distribution that is almost see-through when switched off. When the light is switched on, the pane distributes the light almost entirely without glare.

This pendant lamp is fully office-compatible with a glare value [UGR] of under 19. Bright, efficient and with a sophisticated design, this light not only stands out in any type of office environment.





LED PANEL TRANSPARENT ANGULAR

- **Very low glare value**
- **Light colour adjustable in 2 stages**
- **Transparent luminous element**
- **Max. suspended mounting 1,800 mm**

Housing	Aluminium	Base Length	570 mm
Colour Temperature	3000/4000 K	Base Width	80 mm
Luminous Flux	5600/6100 lm	Base Height	50 mm
Power	53 W	Power Supply Unit incl.	Yes
Rated Input Voltage	220-240 V/AC	Light Beam Angle	360 Degree
Length	295 mm	Control	Leading-edge dimmer, Trailing-edge dimmer
Width	1195 mm	Colour Rendering Index (Ra)	90
Height	12 mm		
Pendulum Length	1800 mm		

Article	Housing Color		Price
342219	Black	WW NW	€ 299.95
342220	Aluminum	WW NW	€ 299.95
342221	White	WW NW	€ 299.95



Onlineshop

You can find more information about the products in the onlineshop: Detailed images, videos, project reports, LDT files, EPREL data sheets and more.



OFFICE ONE

- Very low glare value
- Service life 50,000 h L80B10
- Dimmable using touch sensor
- Ready to use

Housing	Aluminium	Rated Input Voltage	220-240 V/AC
Length	610 mm	Power Supply Unit incl.	Yes
Width	310 mm	Light Beam Angle	110 Degree
Height	1950 mm	Light Beam Angle 2	90 Degree
Base Length	460 mm	Primary Cable Length	1.5 m
Base Width	300 mm	Primary Connection End	Power plug
Base Height	8 mm	Colour Rendering Index	80 (Ra)
Power	80 W		

Article	Housing Color	Colour Temperature	Luminous Flux	Price
343034	Silver	3000 K	6700 lm	€ 819.95
343030	Silver	4000 K	7400 lm	€ 819.95





OFFICE ONE MOTION

- Very low glare value
- Service life 50,000 h L80B10
- Dimmable using touch sensor
- Motion sensor
- Ready to use

Housing	Aluminium	Rated Input Voltage	220-240 V/AC
Length	610 mm	Power Supply Unit incl.	Yes
Width	310 mm	Light Beam Angle	110 Degree
Height	1950 mm	Light Beam Angle 2	90 Degree
Base Length	460 mm	Primary Cable Length	1.5 m
Base Width	300 mm	Primary Connection End	Power plug
Base Height	8 mm	Colour Rendering Index (Ra)	80
Power	80 W		

Article	Housing Color	Colour Temperature	Luminous Flux	Price
343035	Silver	3000 K	6700 lm	€ 949.95
343032	Silver	4000 K	7400 lm	€ 949.95

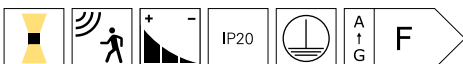

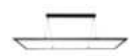



OFFICE ONE TRANSPARENT

Housing	Aluminium	Power	55 W
Colour Temperature	4000 K	Rated Input Voltage	200-240 V/AC
Luminous Flux	6245 lm	Power Supply Unit incl.	No
Length	610 mm	Light Beam Angle	150 Degree
Width	310 mm	Light Beam Angle 2	150 Degree
Height	1950 mm	Primary Cable Length	2.5 m
Base Length	500 mm	Primary Connection End	Power plug
Base Width	225 mm	Colour Rendering Index (Ra)	80
Base Height	8 mm		

Article	Housing Color		Price
343022	<input type="checkbox"/> Silver	NW	€ 819.95







OFFICE TWO

- Very low glare value
- Service life 50,000 h L80B10
- Dimmable using rotary switch
- Ready to use including 2.5 m connecting cable

Housing	Aluminium	Power Supply Unit incl.	No
Colour Temperature	4000 K	Light Beam Angle	110 Degree
Luminous Flux	8300 lm	Light Beam Angle 2	90 Degree
Length	610 mm	Primary Cable Length	2.5 m
Width	280 mm	Primary Connection End	Power plug
Height	1950 mm	Colour Rendering Index (Ra)	80
Power	80 W		
Rated Input Voltage	200-240 V/AC		

Article	Housing Color		Price
343016	<input type="checkbox"/> Silver	NW	€ 749.95





OFFICE THREE

The OFFICE THREE series is our bestseller and problem solver for lighting individual workstations. Available as a free-standing or table lamp, the OFFICE THREE impresses with excellent light quality [Ra95] and glare-free [UGR<6] and ensures fatigue-free working in any situation. Thanks to the individually adjustable brightness for direct and indirect light, OFFICE THREE enables high-quality and flexible illumination of individual workstations. Optimised for tables with standard dimensions of 160 x 80 cm, the series is also suitable for other table sizes.



High-precision radar presence detector

- The 24Ghz presence sensor recognises even the smallest movements on the desk - such as movements of the computer mouse - and switches the light on automatically. Faulty switch-offs are effectively prevented despite the short run-on time.
- Without movement, the brightness is reduced to 30% after 5*/15/30 minutes [*default setting].
- If there is no movement, the light switches off after a further 5*/15/30 minutes [*default setting].

Daylight sensor

- Switch on the light and dim to the desired brightness [this setting is saved by the daylight sensor as the default].
- As soon as the ambient light changes, the sensor adjusts the brightness according to the stored standard [10% tolerance].



Touch panel

- Brightness of direct and indirect light separately or synchronised, infinitely adjustable
- Direct and indirect light can be switched separately
- Continuously adjustable light colour [PRO models only]
- Adjustable run-on time of the presence sensor



Universal table clamp

- table clamp can be used for table tops with a total thickness of 15-65 mm [incl. substructure] as required
- If part of the frame construction runs in the clamping area of the luminaire, the hard rubber buffers supplied must be used to compensate for the unevenness and create a flush clamping area.
- The universal design of the table clamp allows it to be mounted on almost all table tops.



Optional mounting kit

- For larger table tops or for free positioning on the table, the optional mounting kit can be used instead of the pre-installed table clamp. Dieser wird einfach durch ein Bohrloch im Tisch montiert.
- suitable for table tops with a total thickness of 15-35 mm
- suitable for hole diameters from 22-30 mm



OFFICE THREE STANDARD FLOOR

- Ideal for high-quality illumination of individual workstations
- Redesigned and extended lamp head for ideal illumination of 160 x 80 cm tables
- Direct and indirect light can be dimmed and switched separately using touch panel
- Light colour adjustable via touch panel
- High-precision radar presence detector detects the smallest movements
- Daylight sensor for dynamic brightness adjustment

Housing	Aluminium	Power	80 W
Colour Temperature	4000 K	Rated Input Voltage	220-240 V/AC
Luminous Flux	10100 lm	Power Supply Unit incl.	Yes
Length	1240 mm	Light Beam Angle	120 Degree
Width	64 mm	Light Beam Angle 2	50 Degree
Height	1950 mm	Primary Cable Length	2.5 m
Base Length	530 mm	Primary Connection End	Safety plug
Base Width	225 mm	Colour Rendering Index	95 (Ra)
Base Height	10 mm		

Article	Housing Color	Price
342228	<input type="checkbox"/> White	€ 1199.95
342229	<input type="checkbox"/> Silver	€ 1199.95
342230	<input type="checkbox"/> Black	€ 1199.95



Technical data sheet

New in the onlineshop: The technical data sheets offer even more information: Light and energy data, light distribution curves, dimensional drawings and more.



OFFICE THREE STANDARD TABLE

- Optimal for high-quality illumination of height-adjustable individual workstations
- Newly designed and extended lamp head for ideal illumination of 160x80 cm tables
- Suitable for table designs with 15-65 mm thickness
- Direct and indirect light can be dimmed and switched separately using touch panel
- High-precision radar presence detector detects the smallest movements
- Adjustable switch-off delay of the sensor [5/15/30 mins]
- Daylight sensor for dynamic brightness adjustment
- Incl. 2.5 m connecting cable with Schuko plug and C21 mains plug
- Incl. hard rubber buffers for lining table designs running close to the edge

Housing	Aluminium	Rated Input Voltage	220-240 V/AC
Colour Temperature	4000 K	Power Supply Unit incl.	Yes
Luminous Flux	10100 lm	Light Beam Angle	120 Degree
Length	1159 mm	Light Beam Angle 2	50 Degree
Width	64 mm	Primary Cable Length	2.5 m
Height	1194 mm	Primary Connection End	Safety plug
Base Length	500 mm	Colour Rendering Index (Ra)	95
Base Width	225 mm		
Power	80 W		

Article	Housing Color		Price
346063	<input type="checkbox"/> White	NW	€ 999.95
346064	<input type="checkbox"/> Silver	NW	€ 999.95
346065	<input type="checkbox"/> Black	NW	€ 999.95



Accessories for **346063**

930727 Mounting set for table lamp Office Three



Accessories for **346064**

930728 Mounting set for table lamp Office Three



Accessories for **346065**

930729 Mounting set for table lamp Office Three





OFFICE THREE PRO FLOOR

- Optimal for high-quality illumination of individual workstations
- Newly designed and extended lamp head for ideal illumination of 160 x 80 cm tables
- Direct and indirect light can be dimmed and switched separately using touch panel
- High-precision radar presence detector detects the smallest movements
- Adjustable switch-off delay of the sensor [5/15/30 mins]
- Daylight sensor for dynamic brightness adjustment

Housing	Aluminium	Power	80 W
Colour Temperature	2700-6500 K	Rated Input Voltage	220-240 V/AC
Luminous Flux	9000/9800 lm	Power Supply Unit incl.	Yes
Length	1240 mm	Light Beam Angle	120 Degree
Width	64 mm	Light Beam Angle 2	50 Degree
Height	1950 mm	Primary Cable Length	2.5 m
Base Length	530 mm	Primary Connection End	Safety plug
Base Width	225 mm	Colour Rendering Index	95 (Ra)
Base Height	10 mm		

Article	Housing Color		Price
342231	<input type="checkbox"/> White	ww cw	€ 1399.95
342232	<input type="checkbox"/> Silver	ww cw	€ 1399.95
342233	<input type="checkbox"/> Black	ww cw	€ 1399.95



Lighting design

Interested in our lighting design service?

Your contact person will be happy to answer any questions you may have.



OFFICE THREE PRO TABLE

- Optimal for high-quality illumination of height-adjustable individual workstations
- Newly designed and extended lamp head for ideal illumination of 160 x 80 cm tables
- Suitable for table designs with 15-65 mm thickness
- Direct and indirect light can be dimmed and switched separately using touch panel
- Light colour adjustable via touch panel
- Precise radar presence detector detects the smallest movements
- Daylight sensor for dynamic brightness adjustment

Housing	Aluminium	Rated Input Voltage	200-240 V/AC
Colour Temperature	2700-6500 K	Power Supply Unit incl.	Yes
Luminous Flux	9000/9800 lm	Light Beam Angle	120 Degree
Length	1240 mm	Light Beam Angle 2	50 Degree
Width	64 mm	Primary Cable Length	2.5 m
Height	1194 mm	Primary Connection End	Safety plug
Base Length	500 mm	Colour Rendering Index (Ra)	95
Base Width	225 mm		
Power	80 W		

Article	Housing Color		Price
346066	<input type="checkbox"/> White	<input type="checkbox"/> WW <input type="checkbox"/> CW	€ 1199.95
346067	<input type="checkbox"/> Silver	<input type="checkbox"/> WW <input type="checkbox"/> CW	€ 1199.95
346068	<input type="checkbox"/> Black	<input type="checkbox"/> WW <input type="checkbox"/> CW	€ 1199.95



Accessories for **346066**

930727 Mounting set for table lamp Office Three



Accessories for **346067**

930728 Mounting set for table lamp Office Three



Accessories for **346068**

930729 Mounting set for table lamp Office Three



hall floodlights



■
page 238



■
page 240







VEGA

The VEGA high bay light - noticeable quality. High bay lights are the perfect solution for optimal illumination in industrial environments and warehouses. The light variant with three adjustable output levels can be perfectly adapted to your requirements. The spotlights are extremely energy efficient, which has a noticeable impact on your operating costs. The long service life of 50,000 hours (L80B20) ensures reliable lighting into the future, without compromise. With the optional lenses, the VEGA spotlights can achieve a UGR value of less than 19 for guaranteed glare-free illumination. And if you are looking for precise lighting control, we also offer variants with DALI control. The high bay lights are also eligible for German BEG federal funding.





VEGA





- High-quality, flexible and powerful high-bay lights
- Output adjustable in 3 levels
- UGR <19 with optional lens
- Particularly energy-efficient

Housing	Aluminium	Rated Input Voltage	200-240 V/AC
Surface	Powder-coated	Power Supply Unit incl.	Yes
Luminous Flux	15300 / 23400 / 28800 lm	Light Beam Angle	120 Degree
Height	120 mm	Primary Cable Length	1.5 m
Ø	400 mm	Colour Rendering Index (Ra)	80
Power Selectable	90 W, 130 W, 160 W	IK Protection Class	IK09

Article	Housing Color	Colour Temperature	Price
732156	 Black	 4000 K	€ 319.95
732158	 Black	 5700 K	€ 319.95



Accessories

930742	Wall mounting arm for Vega OnOff		€ 39.95
930743	Lense 60° for Vega		€ 49.95
930641	Chain suspension 1m for pendant light Aludra / Vega		€ 14.95
930685	Chain suspension 3m for pendant light Aludra / Vega		€ 24.95

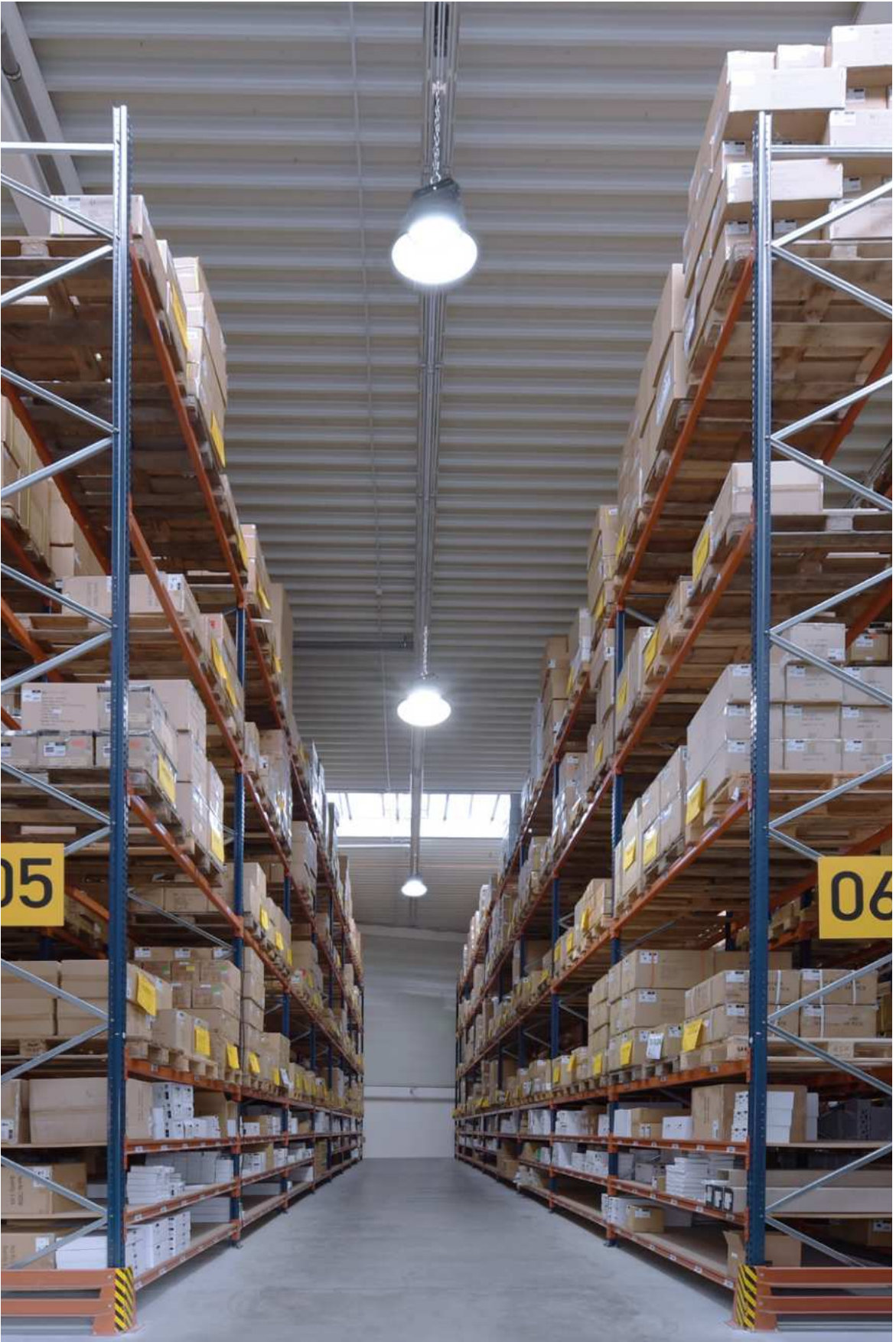



VEGA DALI





- high-quality, versatile and powerful high-bay lights
- UGR <math>< 19</math> with optional lens
- particularly energy efficient

Housing	Aluminium	Power Supply Unit incl.	Yes
Surface	Powder-coated	Light Beam Angle	120 Degree
Luminous Flux	28800 lm	Control	DALI 2 / DT6
Height	122 mm	Primary Cable Length	1.5 m
Ø	400 mm	Colour Rendering Index (Ra)	80
Power	160 W	IK Protection Class	IK09
Rated Input Voltage	200-240 V/AC		

Article	Housing Color	Colour Temperature	Price
732157	■ Black	NW 4000 K	€ 369.95
732159	■ Black	CW 5700 K	€ 369.95



Accessories

930743	Lense 60° for Vega		€ 49.95
930775	Wall mounting arm for Vega DALI		€ 39.95
930641	Chain suspension 1m for pendant light Aludra / Vega		€ 14.95
930685	Chain suspension 3m for pendant light Aludra / Vega		€ 24.95

damp-proof luminaires



■
page 244



■
page 246



■
page 247



□
page 248



□
page 249



□
page 250



□ ■ ■
page 252



□ ■ ■
page 254



□ ■ ■
page 254





TRI PROOF BASIC

Discover our TRIPROOF BASIC wet room moisture-proof luminaire. The moisture-proof luminaires are eligible for German federal funding and are particularly energy efficient, which means lower operating costs for your customers. With durable construction and a long service life, the luminaires are very long-lasting. The pre-installed feed-through wiring and the practical cable entry points on the back significantly simplify installation. The metal clips ensure they are secured reliably. We also offer variants with a motion detector, where the brightness threshold, detection range and switch-off delay can be adjusted.











TRI PROOF BASIC

- Eligible for BEG German federal funding for energy-efficient buildings
- Particularly energy efficient
- Long service life of 50,000 hours L80B50
- Pre-installed feed-through wiring 3x1.5 mm²/5x1.5 mm²
- Cable entry point on the back
- Stainless steel clips on the cover can be locked with screws
- Robust polycarbonate [PC] plastic housing

Housing	Polycarbonate (PC)/ iron	Number in Row max.	15
Colour Temperature	4000 K	Power Supply Unit incl.	Yes
Width	82 mm	Colour Rendering Index (Ra)	80
Height	75 mm	IK Protection Class	IK08
Rated Input Voltage	220-240 V/AC		

Article	Housing Color		Luminous Flux	Length	Power	Price
730483	Grey  		2520 lm	610 mm	18.0 W	€ 54.95
730486	Grey  		5040 lm	1210 mm	36.0 W	€ 79.95
730489	Grey  		7700 lm	1510 mm	55.0 W	€ 94.95



Accessories

930713 Rope suspension for Tri Proof Basic



€ 19.95



TRI PROOF BASIC MOTION

- Eligible for BEG German federal funding for energy-efficient buildings
- Particularly energy efficient
- Long service life of 50,000 hours L80B50
- Pre-installed feed-through wiring 3x1.5 mm²/5x1.5 mm²
- Cable entry point on the back
- Stainless steel clips on the cover can be locked with screws
- Robust polycarbonate [PC] plastic housing
- Adjustable radar motion sensor

Housing	Polycarbonate (PC)/ iron	Number in Row max.	15
Colour Temperature	4000 K	Power Supply Unit incl.	Yes
Width	82 mm	Colour Rendering Index (Ra)	80
Height	75 mm	IK Protection Class	IK08
Rated Input Voltage	220-240 V/AC		

Article	Housing Color	Luminous Flux	Length	Power	Price
730484	Grey	2520 lm	610 mm	18.0 W	€ 74.95
730487	Grey	5040 lm	1210 mm	36.0 W	€ 99.95
730490	Grey	7700 lm	1510 mm	55.0 W	€ 114.95



Accessories

930713 Rope suspension for Tri Proof Basic





€ 19.95



TRI PROOF BASIC DALI

- Eligible for German BEG federal funding
- Can run on emergency power (180-264 V/DC EOFI: 15%)
- particularly energy efficient
- long service life of 50,000 hours L80B50
- Pre-installed feed-through wiring 3x1.5 mm²/5x1.5 mm² (DALI)
- cable entry point on the back
- Stainless steel clips on the cover can be locked with screws
- robust plastic housing

Housing	Polycarbonate (PC)/iron	Power Supply Unit incl. Control	Yes DALI 2 / DT6, Push-Dim
Colour Temperature	4000 K	Colour Rendering Index (Ra)	80
Width	82 mm	IK Protection Class	IK08
Height	75 mm		
Rated Input Voltage	220-240 V/AC		
Number in Row max.	15		

Article	Housing Color	Luminous Flux	Length	Power	Price
730485	Grey  NW	2520 lm	610 mm	18.0 W	€ 104.95
730488	Grey  NW	5040 lm	1210 mm	36.0 W	€ 129.95
730491	Grey  NW	7700 lm	1510 mm	55.0 W	€ 159.95



Accessories

930713 Rope suspension for Tri Proof Basic



€ 19.95



TRI PROOF

Equipped with LEDs in a neutral white light colour [4,000 K], the TRI PROOF LED IP65 damp-proof light consists of a light grey polycarbonate housing and a satin-finished polycarbonate cover in one piece. It is suitable for simple ceiling, wall or suspended mounting and is available in three different lengths. Several lights can be connected in series; ideal for lighting under canopies, in cellar rooms, workshops, garages, industrial halls etc. The light has a simple electrical connection with push-in connector.





TRI PROOF

- Pre-installed feed-through wiring
- Including mounting clips

Housing	Plastic	Power Supply Unit incl.	Yes
Surface	Matt	Light Beam Angle	120 Degree
Colour Temperature	4000 K	Colour Rendering Index (Ra)	80
Width	61 mm	IK Protection Class	IK08
Height	56 mm		
Rated Input Voltage	180-240 V/AC		

Article	Housing Color		Luminous Flux	Length	Power	Number in Row max.	Price
730419	<input type="checkbox"/> White		1430 lm	696 mm	17.0 W	25	€ 49.95
730424	<input type="checkbox"/> White		2980 lm	1296 mm	35.0 W	15	€ 79.95
730425	<input type="checkbox"/> White		3820 lm	1598 mm	44.0 W	10	€ 84.95

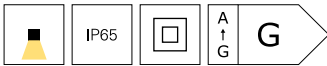

TRI PROOF MOTION

- including mounting clips

Housing	Plastic	Power Supply Unit incl.	Yes
Surface	Matt	Light Beam Angle	120 Degree
Colour Temperature	4000 K	Colour Rendering Index (Ra)	80
Width	61 mm	IK Protection Class	IK08
Height	56 mm		
Rated Input Voltage	220-240 V/AC		

Article	Housing Color		Luminous Flux	Length	Power	Price
730450	<input type="checkbox"/> White		1900 lm	665 mm	18.5 W	€ 59.95
730455	<input type="checkbox"/> White		2500 lm	1145 mm	24.5 W	€ 74.95



Accessories

930071 Rope suspension adjustable for Tri Proof Set 2 pcs



€ 14.95

930072 Surface mounting bracket for Tri Proof 2 pcs



€ 14.95



TRI PROOF SLIM

Watertight, impact-resistant and versatile installation, TRI PROOF SLIM series damp-proof lights are flexible workhorses in an innovative design. Whether in wet areas, cellars, workshops and garages or in warehouses, the IP68-certified SLIMS are impact-resistant up to IK10 and their light emission angle can be infinitely adjusted.





TRI PROOF SLIM

- Particularly impact resistant
- Feed-through wiring possible
- Light direction infinitely adjustable
- IP68 certified
- Including mounting material

Housing	Plastic	Light Beam Angle	100 Degree
Surface	Matt	Swivelling Angle	360 Degree
Colour Temperature	5000 K	Colour Rendering Index (Ra)	80
Ø	39 mm	IK Protection Class	IK10
Rated Input Voltage	220-240 V/AC		
Power Supply Unit incl.	Yes		

Article	Housing Color		Luminous Flux	Height	Power	Number in Row max.	Price
348138	<input type="checkbox"/> White	CW	2265 lm	700 mm	21.0 W	4	€ 89.95
348139	<input type="checkbox"/> White	CW	4575 lm	1300 mm	40.0 W	2	€ 149.95



5-year guarantee

Benefit from the maximum quality promise:
All DEKO-LIGHT brand products come with a five-year manufacturer's guarantee.



SOTANO

The SOTANO series - a classic cellar light in a modern design with LED technology. This incredibly versatile and robust light is the perfect solution for a wide range of applications. The cellar light is extremely flexible thanks to a 3,000/4,000 K CCT switch and 4.5/7.5 W power switch that allow the light colour and output to be adjusted according to the application and requirements. The cable entries on multiple sides enable flexible and simple installation. The light is also robust and durable thanks to its IP54 protected housing, impact resistance according to IK08 and impressive service life of 72,000 hours according to L80B10.





SOTANO

- Classic cellar light with modern LED technology
- Colour temperature adjustable (3,000/4,000 K) via slide switch
- Output adjustable in two stages (4.5/7.5 W) via slide switch
- Five cable entry points on multiple sides
- Flexible installation

Housing	Polycarbonate	Power Selectable	4.5 W, 7.5 W
Colour Temperature	3000/4000 K	Rated Input Voltage	220-240 V/AC
Luminous Flux	450/750 lm	Power Supply Unit incl.	Yes
Length	165 mm	Light Beam Angle	120 Degree
Width	120 mm	IK Protection Class	IK08
Height	65 mm		

Article	Housing Color		Price
731160	<input type="checkbox"/> White	ww nw	€ 16.95
731161	<input type="checkbox"/> Grey	ww nw	€ 16.95
731162	<input type="checkbox"/> Black	ww nw	€ 16.95



Onlineshop

You can find more information about the products in the onlineshop:
Detailed images, videos, project reports, LDT files, EPREL data sheets and more.



SOTANO RETRO ROUND

- Classic, low-cost cellar lamp
- Replaceable E27 lamp
- Cable entry on multiple sides
- Several mounting points for flexible installation

Housing	PP - Polypropylene	Rated Input Voltage	220-240 V/AC
Height	100 mm	Control	Dimmable via optional light source
Ø	180 mm	IK Protection Class	IK06
Max. Power	1x max. 60 W		

Article	Housing Color	Price
731163	<input type="checkbox"/> White	€ 12.95
731164	<input type="checkbox"/> Grey	€ 12.95
731165	<input type="checkbox"/> Black	€ 12.95



SOTANO RETRO OVAL

- classic, low-cost cellar light
- replaceable E27 lamp
- Cable entry on multiple sides
- Several fixing points for flexible installation

Housing	PP - Polypropylene	Rated Input Voltage	220-240 V/AC
Length	186 mm	Control	Dimmable via optional light source
Width	122 mm	IK Protection Class	IK06
Height	108 mm		
Max. Power	1x max. 60 W		

Article	Housing Color	Price
731166	<input type="checkbox"/> White	€ 9.95
731167	<input type="checkbox"/> Grey	€ 9.95
731168	<input type="checkbox"/> Black	€ 9.95







POWER RAILS

- 258 D ONE 1-phase power rail system
- 276 1-phase power rail luminaires
- 290 D LINE 3-phase power rail system
- 322 D LINE DALI 3-phase power rail system
- 348 3-phase power rail luminaires

D ONE system



page 264



page 266



page 266



page 267



page 268



page 268



page 269



page 269



page 270



page 270



page 271



page 272



□ ■
page 272



□ ■
page 273



□ ■
page 274



□ ■
page 274

D ONE MOUNTING POWER RAIL SYSTEM 1-PHASE 230V

mounting modules	illust.	white	black	page
mounting power rail L: 1000 mm	01	720000	720003	265
mounting power rail L: 2000 mm	01	720001	720004	265
mounting power rail L: 3000 mm	01	720002	720005	265
feeder left	02	720006	720007	266
feeder right	03	720008	720009	266
flex feeder with ceiling canopy	04	720010	720011	267
electrical straight connector with center feed option	05	720012	720013	268
electrical connector	06	720014	720015	268
90°-joint left	07	720016	720017	269
90°-joint right	08	720018	720019	269
T-joint left-right-right	09	720020	720021	271
T-joint right-right-left	10	720022	720023	270
T-joint left-left-right	11	720024	720025	271
T-joint right-left-left	12	720026	720027	270
X-joint left-left-right-right	13	720028	720029	272
endcap	14	720030	720031	272
ceiling mounting bracket flex	15	720032	720033	274
wire suspension bracket 3000 mm	16	720034	720035	274
1-phase adapter for light installation	17	720036	720037	273

ILLUSTRATIONS WITH PLANNING-RELEVANT DIMENSIONS

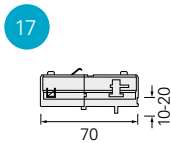
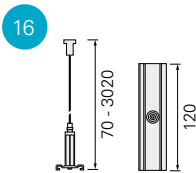
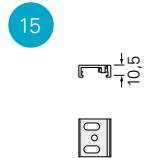
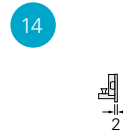
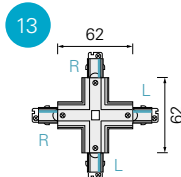
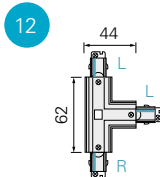
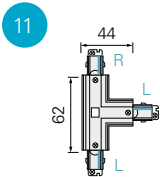
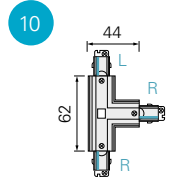
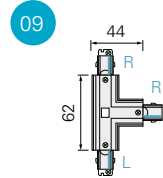
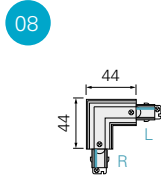
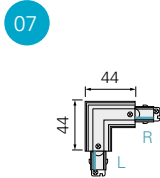
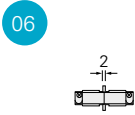
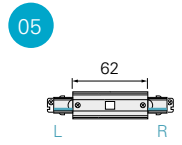
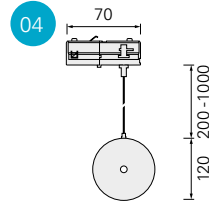
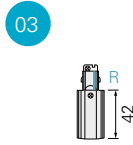
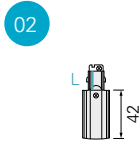
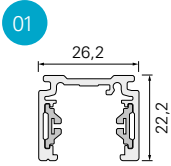

FIXING POINTS

power rail	a	b	c	d
1000 mm	125 mm			
2000 mm	125 mm	870 mm		
3000 mm	125 mm		790 mm	1160 mm

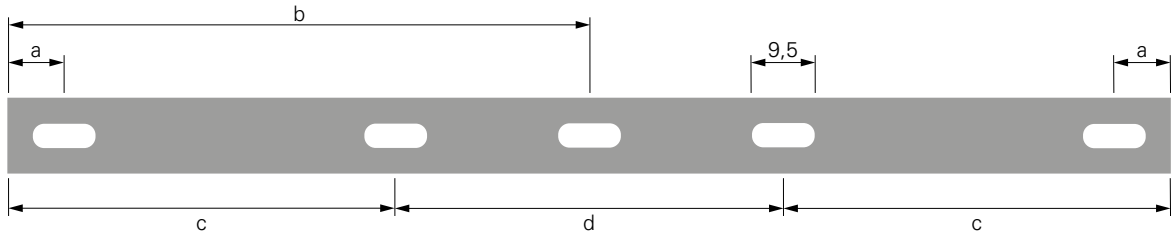

MECHANICAL LOAD TRACK POWER RAIL 1000 MM

10 N $\hat{=}$ 1,02 kg
dimension in mm

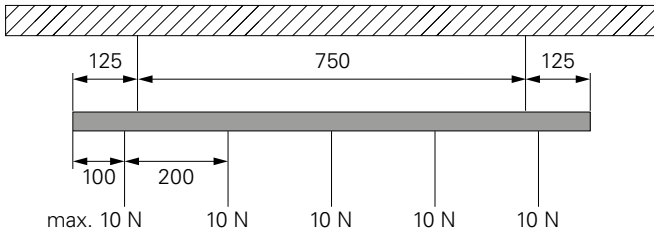

MECHANICAL LOAD TRACK POWER RAIL 2000MM

10 N $\hat{=}$ 1,02 kg
dimension in mm

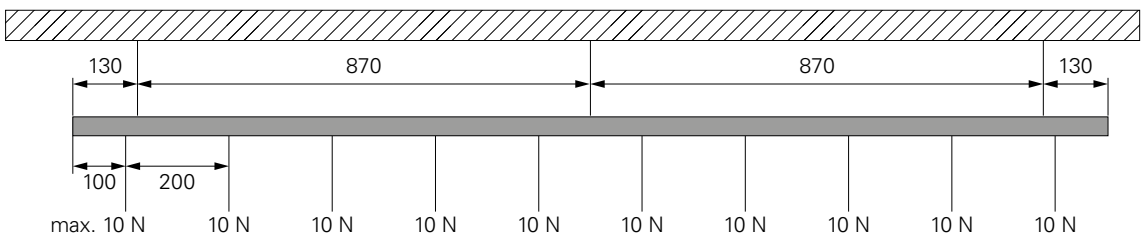

MECHANICAL LOAD TRACK POWER RAIL 3000MM

10 N $\hat{=}$ 1,02 kg
dimension in mm

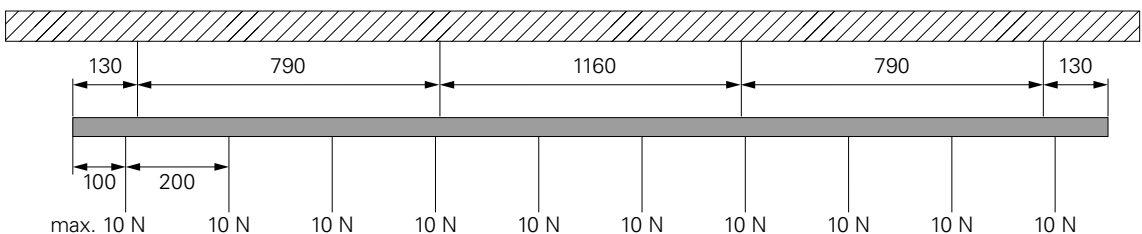

PLANNING GUIDE D ONETRACK SYSTEM 1-PHASE 230V

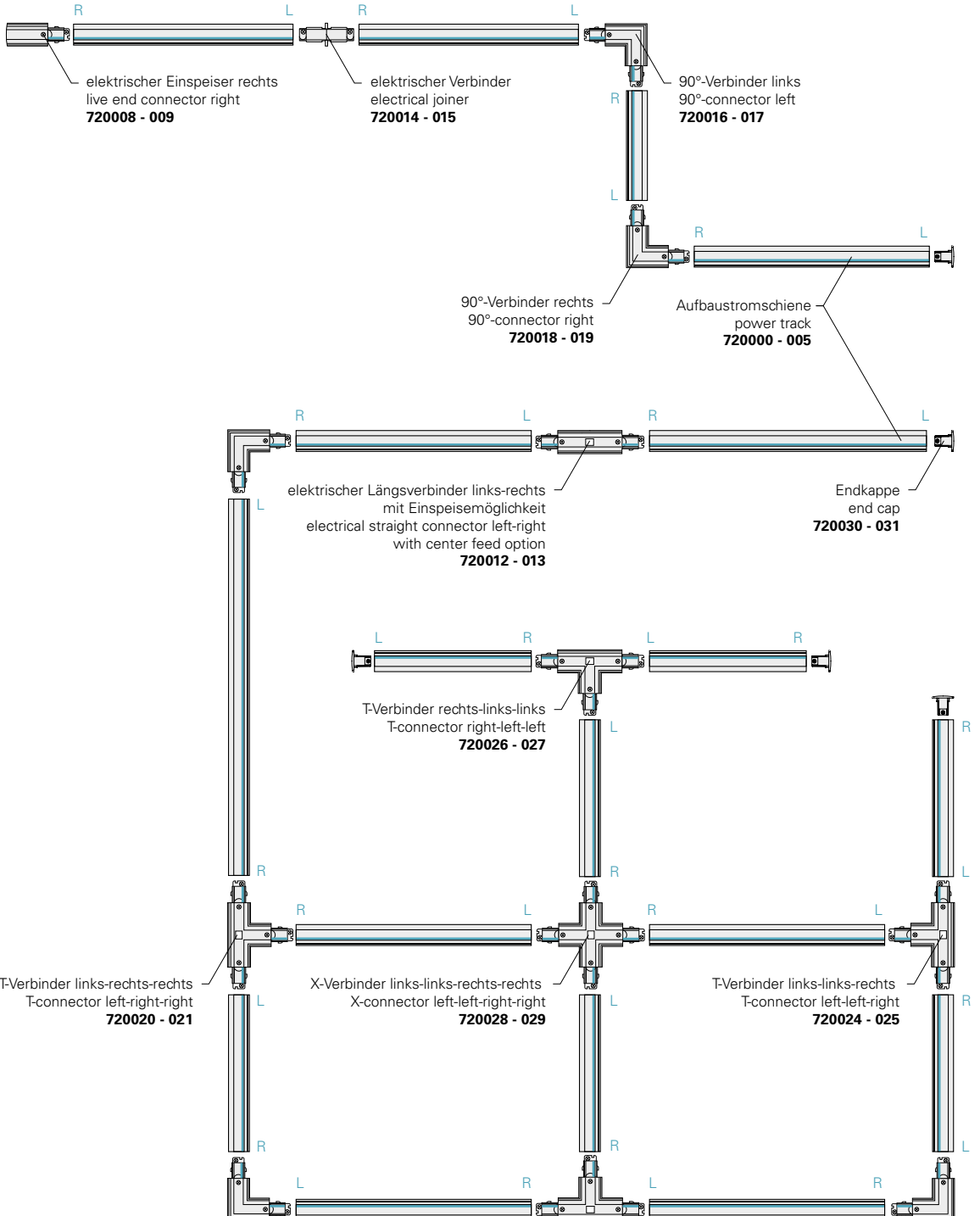
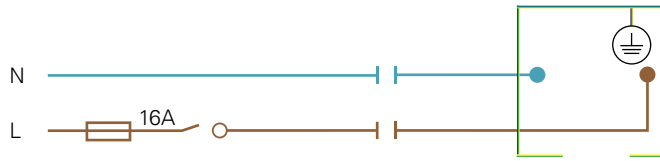
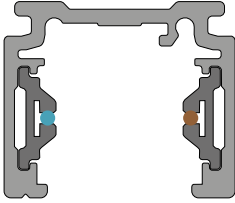



D ONE SURFACE-MOUNTED POWER TRACK

D ONE is the 230 V single-phase busbar system from DE-KO-LIGHT. The extremely compact and sophisticated system combines the benefits of 48 V low-voltage busbars [slim design] with the practical advantages of fully fledged 230 V systems [no transformer needed]. All D ONE components fit seamlessly into a wide range of environments thanks to their small dimensions, giving private living spaces and commercial facilities such as shops and bars a classic, discreet, timeless look. All D ONE components are available in black and white for universal use, and allow a wide range of installation options for flexible application. Thanks to the flex feed including ceiling baldachin, D ONE busbars can be installed even if the power connection is not in the immediate vicinity.



D ONE SURFACE-MOUNTED POWERTRACK

- elegant and compact mini design
- easy to install
- many different designs available
- Mini design with one current phase

Housing	Aluminium	Rated Input Voltage	220-240 V/AC
Width	26.2 mm	Output Current	16 A
Height	22.2 mm		

Article	Housing Color	Length	Price
720000	<input type="checkbox"/> White	1000 mm	€ 39.95
720003	<input checked="" type="checkbox"/> Black	1000 mm	€ 39.95
720001	<input type="checkbox"/> White	2000 mm	€ 69.95
720004	<input checked="" type="checkbox"/> Black	2000 mm	€ 69.95
720002	<input type="checkbox"/> White	3000 mm	€ 99.95
720005	<input checked="" type="checkbox"/> Black	3000 mm	€ 99.95



Lighting design

Interested in our lighting design service?

Your contact person will be happy to answer any questions you may have.



D ONE ELECTRIC FEEDER LEFT

- Power can be fed in from above (ceiling) or from the side
- Elegant and compact mini design
- Simple installation
- Enables flexible installation options

Housing	Plastic	Height	22.2 mm
Length	71 mm	Rated Input Voltage	220-240 V/AC
Width	26 mm	Output Current	16 A

Article	Housing Color	Price
720006	<input type="checkbox"/> White	€ 13.95
720007	<input checked="" type="checkbox"/> Black	€ 13.95



D ONE ELECTRIC FEEDER RIGHT

- Power can be fed in from above (ceiling) or from the side
- elegant and compact mini design
- easy to install
- enables flexible installation options

Housing	Plastic	Height	22.2 mm
Length	71 mm	Rated Input Voltage	220-240 V/AC
Width	26 mm	Output Current	16 A

Article	Housing Color	Price
720008	<input type="checkbox"/> White	€ 13.95
720009	<input checked="" type="checkbox"/> Black	€ 13.95





D ONE FLEX FEEDER WITH CEILING CANOPY

- elegant and compact mini design
- easy to install
- Power supply via ceiling baldachin/current track adapter [200 - 1000mm]
- enables flexible installation options

Housing	Plastic, Metal	Rated Input Voltage	220-240 V/AC
Length	1000 mm	Output Current	6 A
Width	120 mm	Connected Load max.	1320 W
Height	28 mm		

Article	Housing Color	Price
720010	<input type="checkbox"/> White	€ 39.95
720011	<input checked="" type="checkbox"/> Black	€ 39.95





D ONE ELECTRICAL STRAIGHT CONNECTOR WITH FEED OPTION

- elegant and compact mini design
- easy to install
- Power supply via ceiling

Housing	Plastic	Height	22.2 mm
Length	121 mm	Rated Input Voltage	220-240 V/AC
Width	26 mm	Output Current	16 A

Article	Housing Color	Price
720012	<input type="checkbox"/> White	€ 24.95
720013	<input checked="" type="checkbox"/> Black	€ 24.95



D ONE MINI-STRAIGHT CONNECTOR

- elegant and compact mini design
- easy to install

Housing	Plastic	Height	22 mm
Length	62 mm	Rated Input Voltage	220-240 V/AC
Width	26 mm	Output Current	16 A

Article	Housing Color	Price
720014	<input type="checkbox"/> White	€ 8.95
720015	<input checked="" type="checkbox"/> Black	€ 8.95



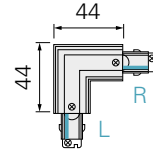

D ONE 90°-CONNECTOR LEFT

- Power can be fed in from the ceiling
- elegant and compact mini design
- easy to install
- enables many different design shapes

Housing	Plastic	Height	22.2 mm
Length	73 mm	Rated Input Voltage	220-240 V/AC
Width	73 mm	Output Current	16 A

Article	Housing Color	Price
720016	<input type="checkbox"/> White	€ 24.95
720017	<input checked="" type="checkbox"/> Black	€ 24.95

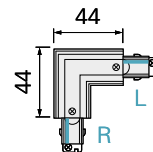

D ONE 90°-CONNECTOR RIGHT

- Power can be fed in from the ceiling
- Elegant and compact mini design
- Simple installation
- Enables many different design shapes

Housing	Plastic	Height	22.2 mm
Length	73 mm	Rated Input Voltage	220-240 V/AC
Width	73 mm	Output Current	16 A

Article	Housing Color	Price
720018	<input type="checkbox"/> White	€ 24.95
720019	<input checked="" type="checkbox"/> Black	€ 24.95



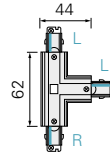

D ONE T-CONNECTOR RIGHT-LEFT-LEFT

- Power can be fed in from the ceiling
- Elegant and compact mini design
- Simple installation
- Enables many different design shapes

Housing	Plastic	Height	22.2 mm
Length	121 mm	Rated Input Voltage	220-240 V/AC
Width	73 mm	Output Current	16 A

Article	Housing Color	Price
720026	<input type="checkbox"/> White	€ 34.95
720027	<input checked="" type="checkbox"/> Black	€ 34.95

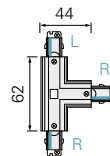

D ONE T-CONNECTOR RIGHT-RIGHT-LEFT

- Power can be fed in from the ceiling
- elegant and compact mini design
- easy to install
- enables many different design shapes

Housing	Plastic	Height	22.2 mm
Length	121 mm	Rated Input Voltage	220-240 V/AC
Width	73 mm	Output Current	16 A

Article	Housing Color	Price
720022	<input type="checkbox"/> White	€ 34.95
720023	<input checked="" type="checkbox"/> Black	€ 34.95

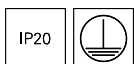

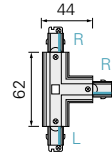

D ONE-CONNECTOR LEFT-RIGHT-RIGHT

- Power can be fed in from the ceiling
- elegant and compact mini design
- easy to install
- enables many different design shapes

Housing	Plastic	Height	22.2 mm
Length	121 mm	Rated Input Voltage	220-240 V/AC
Width	73 mm	Output Current	16 A

Article	Housing Color	Price
720020	<input type="checkbox"/> White	€ 34.95
720021	<input checked="" type="checkbox"/> Black	€ 34.95

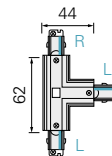

D ONE-CONNECTOR LEFT-LEFT-RIGHT

- Power can be fed in from the ceiling
- elegant and compact mini design
- easy to install
- enables many different design shapes

Housing	Plastic	Height	22.2 mm
Length	121 mm	Rated Input Voltage	220-240 V/AC
Width	73 mm	Output Current	16 A

Article	Housing Color	Price
720024	<input type="checkbox"/> White	€ 34.95
720025	<input checked="" type="checkbox"/> Black	€ 34.95



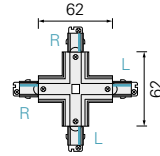

D ONE X-CONNECTOR

- Power can be fed in from the ceiling
- elegant and compact mini design
- easy to install
- enables many different design shapes

Housing	Plastic	Height	22.2 mm
Length	121 mm	Rated Input Voltage	220-240 V/AC
Width	121 mm	Output Current	16 A

Article	Housing Color	Price
720028	<input type="checkbox"/> White	€ 49.95
720029	<input checked="" type="checkbox"/> Black	€ 49.95



D ONE END CAP

- Current touch protection
- for closing open current track ends

Housing	Plastic	Width	26 mm
Length	15 mm	Height	22.2 mm

Article	Housing Color	Price
720030	<input type="checkbox"/> White	€ 3.95
720031	<input checked="" type="checkbox"/> Black	€ 3.95



D ONE 1-PHASE ADAPTER FOR LIGHT INSTALLATION

- elegant and compact mini design
- easy to install
- 230 V adapter for converting lights
- Delivery incl. mounting material (reduction bush, flat nut, strain relief)

Housing	Plastic, Metal	Rated Input Voltage	220-240 V/AC
Length	70 mm	Output Current	6 A
Width	26 mm	Loading Weight max.	1 kg
Height	30 mm	Load Force max.	100 N

Article	Housing Color	Price
720036	<input type="checkbox"/> White	€ 16.95
720037	<input checked="" type="checkbox"/> Black	€ 16.95





D ONE MOUNTING BRACKET FLEX

- Simplifies the installation of more complex track shapes
- Many different design shapes possible
- Expands options for installation

Housing	Metal	Width	28 mm
Length	30 mm	Height	10.5 mm

Article	Housing Color	Price
720032	White	€ 5.95
720033	Black	€ 5.95



D ONE ROPE SUSPENSION BRACKET

- stylish and sophisticated suspended mounting
- many different designs available
- expands options for installation
- Suspension dimension can be individually shortened: 70 - 3020 mm

Housing	Metal	Width	28 mm
Length	120 mm	Height	3020 mm

Article	Housing Color	Price
720034	White	€ 19.95
720035	Black	€ 19.95

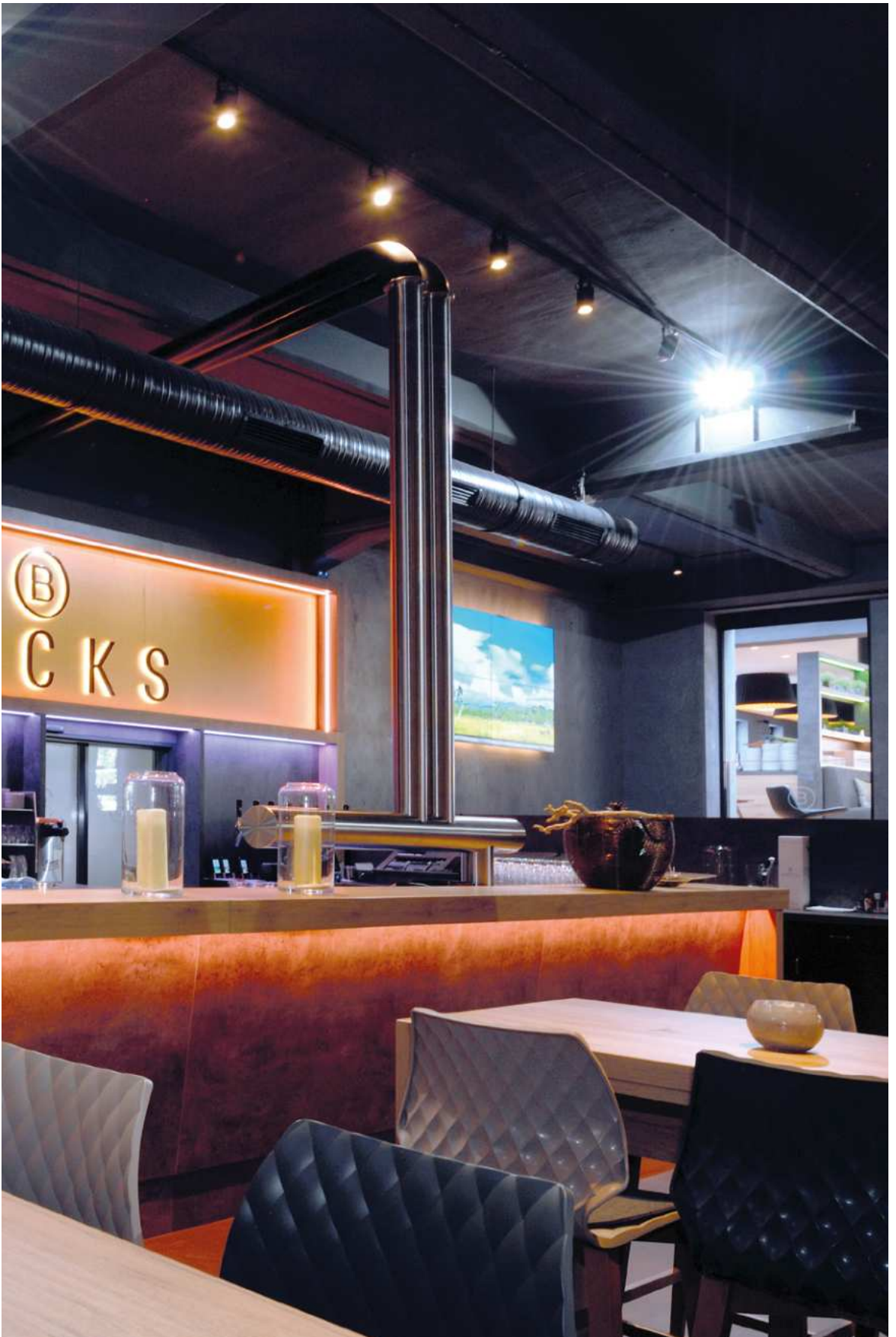

1-phase power rail luminaires



page 278



page 280



page 282



page 284



page 286



page 287



page 288



page 289



CAN

The CAN series is an all-round solution for private and commercial use. Available as a track light, pendant light, ceiling light, wall light, reading light and outdoor light, the CAN feels at home in living rooms, hotel rooms, restaurants and many other environments. All versions have the GU10 socket in common, which enables flexible selection and easy replacement of the light source.



page 51



page 88



page 90



page 91



page 180



page 194



page 195



page 364



page 439



CAN

- customised lighting solution thanks to replaceable light source
- can be combined with the product family of the CAN series

Housing	Aluminium, Polycarbonate	Rated Input Voltage	220-240 V/AC
Length	134 mm	Control	Dimmable via optional light source
Ø	60 mm	Rotation Angle	350 Degree
Sockets	1	Swivelling Angle	90 Degree
Max. Power	1x max. 7.5 W		

Article	Housing Color	Price
707155	<input type="checkbox"/> White	€ 39.95
707156	<input checked="" type="checkbox"/> Black	€ 39.95



Accessories

930301	Reflector ring white for series Klara / Nihal Mini / Rigel Mini / Can		€ 4.95
930302	Reflector ring black for series Klara / Nihal Mini / Rigel Mini / Can		€ 4.95
930303	Reflector ring gold for series Klara / Nihal Mini / Rigel Mini / Can		€ 4.95
930366	Reflector ring silver for series Klara / Nihal Mini / Rigel Mini / Can		€ 4.95



Light sources

For all lights and bases:

You can find the right light sources in the »Light sources« section.



NIHAL MINI



















• can be rotated and swivelled

Housing	Aluminium, Polycarbonate	Power Supply Unit incl.	Yes
Colour Temperature	2700 K	Light Beam Angle	36 Degree
Luminous Flux	720 lm	Rotation Angle	350 Degree
Length	94 mm	Swivelling Angle	350 Degree
Width	102 mm	Control	Leading-edge dimmer, Trailing-edge dimmer
Height	126 mm	Colour Rendering Index (Ra)	90
Ø	60 mm		
Power	10.9 W		
Rated Input Voltage	220-240 V/AC		

Article	Housing Color		Price
707185	<input type="checkbox"/> White		€ 144.95
707186	<input checked="" type="checkbox"/> Black		€ 144.95



Accessories

930297	Side cover white for series Nihal Mini		€ 3.95
930298	Side cover black for series Nihal Mini		€ 3.95
930364	Side cover silver for series Nihal Mini		€ 3.95
930299	Side cover gold for series Nihal Mini		€ 3.95
930300	Side cover wood look walnut series Nihal Mini		€ 5.95
930768	Side cover natural oak wood look series Nihal Mini		€ 5.95
930301	Reflector ring white for series Klara / Nihal Mini / Rigel Mini / Can		€ 4.95
930302	Reflector ring black for series Klara / Nihal Mini / Rigel Mini / Can		€ 4.95
930303	Reflector ring gold for series Klara / Nihal Mini / Rigel Mini / Can		€ 4.95
930366	Reflector ring silver for series Klara / Nihal Mini / Rigel Mini / Can		€ 4.95
930765	Reflector 24° for series Nihal Mini		€ 10.95
930305	Reflector 36° for series Klara / Nihal Mini / Rigel Mini / Uni II		€ 3.6
930306	Reflector 48° for series Klara / Nihal Mini / Rigel Mini / Uni II		€ 8.95
930307	Honeycomb filter for series Klara / Nihal Mini / Rigel Mini / Uni II		€ 8.95
Accessories			
930308	Spread lense for series Klara / Nihal Mini / Rigel Mini / Uni II		€ 8.95
930309	Softening lense for series Klara / Nihal Mini / Rigel Mini / Uni II		€ 8.95
930310	Linear spread lense for series Klara / Nihal Mini / Rigel Mini / Uni II		€ 8.95
930767	Lense 12° for series Nihal Mini		€ 10.95

**Technical data sheet**

New in the onlineshop: The technical data sheets offer even more information: Light and energy data, light distribution curves, dimensional drawings and more.



UNI II MINI











- „Glow“ effect on the reflector ring
- Rotatable and swivelling
- Can be customised with a wide range of accessories

Housing	Aluminium, Steel, Polycarbonate	Light Beam Angle	36 Degree
Colour Temperature	2700 K	Rotation Angle	350 Degree
Height	128 mm	Swivelling Angle	90 Degree
Ø	75 mm	Control	Leading-edge dimmer, Trailing-edge dimmer
Power	11.3 W	Colour Rendering Index (Ra)	90
Rated Input Voltage	220-240 V/AC		
Power Supply Unit incl.	Yes		

Article	Housing Color		Luminous Flux	Price
707188	■ Black		645 lm	€ 129.95
707187	□ White		710 lm	€ 129.95



Accessories

930326	Cover back white for series Uni II Mini		€ 3.55
930327	Cover back black for series Uni II Mini		€ 3.45
930328	Cover heatsink white for series Uni II Mini		€ 3.55
930329	Cover heatsink black for series Uni II Mini		€ 2.95
930330	Reflector ring white for series Uni II Mini		€ 10.95
930331	Reflector ring black for series Uni II Mini		€ 10.95
930332	Reflector ring gold for series Uni II Mini		€ 10.95
930333	Reflector ring chrome for series Uni II Mini		€ 10.95
930770	Reflector 24° for series Uni II Mini		€ 10.95
930771	Reflector 48° for series Uni II Mini		€ 10.95



page 76



page 142

**Onlineshop**

You can find more information about the products in the onlineshop:
Detailed images, videos, project reports, LDT files, EPREL data sheets and more.



SLIM

- glare-free thanks to low UGR value (<19)
- slim design with just 39 mm diameter
- incl. silver-coloured reflector ring

Housing	Aluminium	Light Beam Angle	36 Degree
Colour Temperature	2700 K	Rotation Angle	330 Degree
Luminous Flux	500 lm	Swivelling Angle	60 Degree
Length	197 mm	Control	Leading-edge dimmer, Trailing-edge dimmer
Ø	39 mm	Colour Rendering Index (Ra)	90
Power	5 W		
Rated Input Voltage	220-240 V/AC		
Power Supply Unit incl.	Yes		

Article	Housing Color		Price
707201	<input type="checkbox"/> White		€ 79.95
707202	<input checked="" type="checkbox"/> Black		€ 79.95



Accessories

930744	Reflector-ring white for series Slim		€ 4.95
930745	Reflector-ring black for series Slim		€ 4.95
930746	Reflector-ring gold for series Slim		€ 5.95
930748	Lense 36° for series Slim		€ 4.95
930749	Lense 60° for series Slim		€ 4.95





SLIM

- extra-soft fabric cable
- glare-free thanks to low UGR value (<19)
- slim design with just 39 mm diameter
- max. suspended mounting: 1,800 mm

Housing	Aluminium	Rated Input Voltage	220-240 V/AC
Colour Temperature	2700 K	Power Supply Unit incl.	Yes
Luminous Flux	500 lm	Light Beam Angle	24 Degree
Length	1800 mm	Control	Leading-edge dimmer, Trailing-edge dimmer
Height	300 mm	Colour Rendering Index (Ra)	90
Ø	39 mm		
Pendulum Length	1800 mm		
Power	5 W		

Article	Housing Color		Price
707163	Black		€ 89.95
707164	White		€ 89.95



Accessories

930744	Reflector-ring white for series Slim		€ 4.95
930745	Reflector-ring black for series Slim		€ 4.95
930746	Reflector-ring gold for series Slim		€ 5.95
930748	Lense 36° for series Slim		€ 4.95
930749	Lense 60° for series Slim		€ 4.95









LUCEA

- incl. black reflector ring
- Can be customised with a wide range of accessories

Housing	Aluminium	Rotation Angle	350 Degree
Colour Temperature	2700 K	Swivelling Angle	90 Degree
Height	157 mm	Control	Leading-edge dimmer, Trailing-edge dimmer
Ø	65 mm	Colour Rendering Index (Ra)	90
Rated Input Voltage	200-240 V/AC		
Power Supply Unit incl.	Yes		
Light Beam Angle	36 Degree		

Article	Housing Color	Luminous Flux	Power	Price
707165	<input type="checkbox"/> White 	800 lm	6.0 W	€ 84.95
707166	<input checked="" type="checkbox"/> Black 	800 lm	6.0 W	€ 84.95
707167	<input type="checkbox"/> White 	1300 lm	10.0 W	€ 89.95
707168	<input checked="" type="checkbox"/> Black 	1300 lm	10.0 W	€ 89.95



Accessories

930679	Lense 24° for Lucea 6/10 W		€ 9.95
930752	Blind cover for Lucea 6/10 white		€ 22.95
930753	Blind cover for Lucea 6/10 black		€ 22.95
930756	Reflector ring for Lucea 6/10 white		€ 4.95
930757	Reflector ring for Lucea 6/10 black		€ 4.95
930758	Reflector ring for Lucea 6/10 Gold		€ 4.95





LUCEA

- Particularly soft textile cable
- incl. black reflector ring

Housing	Aluminium	Power Supply Unit incl.	Yes
Colour Temperature	2700 K	Light Beam Angle	36 Degree
Height	157 mm	Control	Leading-edge dimmer, Trailing-edge dimmer
Ø	65 mm	Colour Rendering Index (Ra)	90
Pendulum Length	1600 mm		
Rated Input Voltage	200-240 V/AC		

Article	Housing Color		Luminous Flux	Power	Price
707175	<input type="checkbox"/> White		800 lm	6.0 W	€ 114.95
707176	<input checked="" type="checkbox"/> Black		800 lm	6.0 W	€ 114.95
707177	<input type="checkbox"/> White		1300 lm	10.0 W	€ 119.95
707178	<input checked="" type="checkbox"/> Black		1300 lm	10.0 W	€ 119.95



Accessories

930679	Lense 24° for Lucea 6/10 W		€ 9.95
930752	Blind cover for Lucea 6/10 white		€ 22.95
930753	Blind cover for Lucea 6/10 black		€ 22.95
930756	Reflector ring for Lucea 6/10 white		€ 4.95
930757	Reflector ring for Lucea 6/10 black		€ 4.95
930758	Reflector ring for Lucea 6/10 Gold		€ 4.95



page 48

page 84

page 85

page 286



LUCEA DTW

- **Dim-to-warm 1,800K - 2,700K**
- **incl. black reflector ring**
- **Can be customised with a wide range of accessories**

Housing	Aluminium	Swivelling Angle	90 Degree
Colour Temperature	1800-2700 K	Dimmable	Yes
Luminous Flux	750 lm	Control	Leading-edge dimmer, Trailing-edge dimmer
Height	249 mm		
Ø	65 mm	Colour Rendering Index (Ra)	90
Power	10 W	Protection Class	Protection class I/ protective grounding
Rated Input Voltage	200-240 V/AC	Light Direction	Below
Power Supply Unit incl.	Yes	IP Protection Type	IP 20
Light Beam Angle	36 Degree		
Rotating and Swivelling Range	Rotatable, Swivelling		
Rotation Angle	350 Degree		

Article	Housing Color	Price
707211	White	€ 99.95
707212	Black	€ 99.95



Accessories

930752	Blind cover for Lucea 6/10 white		€ 22.95
930753	Blind cover for Lucea 6/10 black		€ 22.95
930756	Reflector ring for Lucea 6/10 white		€ 4.95
930757	Reflector ring for Lucea 6/10 black		€ 4.95
930758	Reflector ring for Lucea 6/10 Gold		€ 4.95





LUCEA DTW

- high colour rendering
- Dim-to-warm 1,800K-2,700K
- incl. black reflector ring

Housing	Aluminium	Rated Input Voltage	200-240 V/AC
Colour Temperature	1800-2700 K	Power Supply Unit incl.	Yes
Luminous Flux	750 lm	Light Beam Angle	36 Degree
Height	157 mm	Control	Leading-edge dimmer, Trailing-edge dimmer
Ø	65 mm	Colour Rendering Index (Ra)	90
Pendulum Length	1800 mm		
Power	10 W		

Article	Housing Color		Price
707215	<input type="checkbox"/> White		€ 129.95
707216	<input checked="" type="checkbox"/> Black		€ 129.95



Accessories

930752	Blind cover for Lucea 6/10 white		€ 22.95
930753	Blind cover for Lucea 6/10 black		€ 22.95
930756	Reflector ring for Lucea 6/10 white		€ 4.95
930757	Reflector ring for Lucea 6/10 black		€ 4.95
930758	Reflector ring for Lucea 6/10 Gold		€ 4.95



page 46 page 80 page 82 page 374 page 378

D LINE system



□ ■ ●
page 308



□ ■ ●
page 308



□ ■ ●
page 309



□ ■ ● □
page 310



□ ■
page 310



□ ■ ●
page 311



□ ■ ●
page 311



□ ■ ●
page 312



□ ■ ●
page 313



□ ■ ●
page 313



□ ■ ●
page 314



□ ■ ●
page 314



■
page 315



■
page 315



□ ■ ■
page 316



□ ■ ■
page 318



□ ■
page 319



□ ■ ■
page 320



□ ■ ■
page 320



□ ■ ■
page 321



□ ■ ■
page 301



□
page 302



■
page 302



□ ■ ■
page 303



□ ■ ■
page 304



□ ■ ■
page 304



□ ■ ■
page 305



□ ■ ■
page 305



□ ■ ■
page 306



□ ■ ■
page 306



□ ■ ■
page 307

D LINE MOUNTING POWER RAIL SYSTEM 3-PHASE 230V

mounting modules	illust.	white	grey	black	page
mounting power rail L: 1000 mm	01	710000	710001	710002	301
mounting power rail L: 2000 mm	01	710003	710004	710005	301
mounting power rail L: 3000 mm	01	710006	710007	710008	301
mounting adapter for lights	02	710045	710046	710047	303
live end feeder left	03	710009	710010	710011	304
live end feeder right side	04	710012	710013	710014	304
electrical straight connector with center feed option	05	710042	710043	710044	305
flexible-connector left-right side	06	710039	710040	710041	305
electrical joint	07	710015	710016	710017	306
mechanical joint	08	710018	710019	710020	306
90°-joint left-right with exchange mechanism	09	710036	710037	710038	307
T-joint left-left-right with exchange mechanism	10	710027	710028	710029	308
T-joint right-right-left with exchange mechanism	11	710030	710031	710032	308
X-joint left-left-right-right	12	710033	710034	710035	309
cover plate built in track	13	710077	-	710079	310
endcap	14	710066	710067	710068	310
ceiling mounting bracket flex	15	710063	710064	710065	311
suspension clamp for track connection	16	710057	710058	710059	312
ceiling suspension rigid [635 mm] with canopy	17	710078	710085	710084	313
extension for ceiling suspension [300 mm]	17	710086	710088	710087	313
wire suspension bracket with ceiling rosette 1500 mm	18	710048	710049	710050	314
rope suspension bracket Mini mit Abhängeseil 5000 mm	19	710094	710095	710096	314
quick mounting bracket for grid ceilings	20	710051	710052	710053	317
D Line/Dali wall bracket	21	710104	710105	710106	311
truss adapter silver coloured	22	-	710083	-	315
quick mounting clamp for exhibition stand construction	23	-	-	710082	315
3-circuits adapter for light installation	24	710097	710098	710099	318
3-circuits adapter with Multi CC power supply 250/350/450/500 mA 6,30 - 21,00 W 25-42V	25	862180	-	862183	319
3-circuits adapter with Multi CC power supply 600/700/750/800 mA 15,00 - 33,60 W 25-42V	25	862181	-	862184	319
3-circuits adapter with Multi CC power supply 850/900/950/1050 mA 23,00 - 44,10 W 27-42V	25	862182	-	862185	319
electrical outlet adapter	26	710024	710025	710026	320
mounting adapter for additional components max. 10kg	27	710054	710055	710056	320
signs hook, max. load 5kg	28	710060	710061	710062	321

ILLUSTRATIONS WITH PLANNING RELEVANT DIMENSIONS

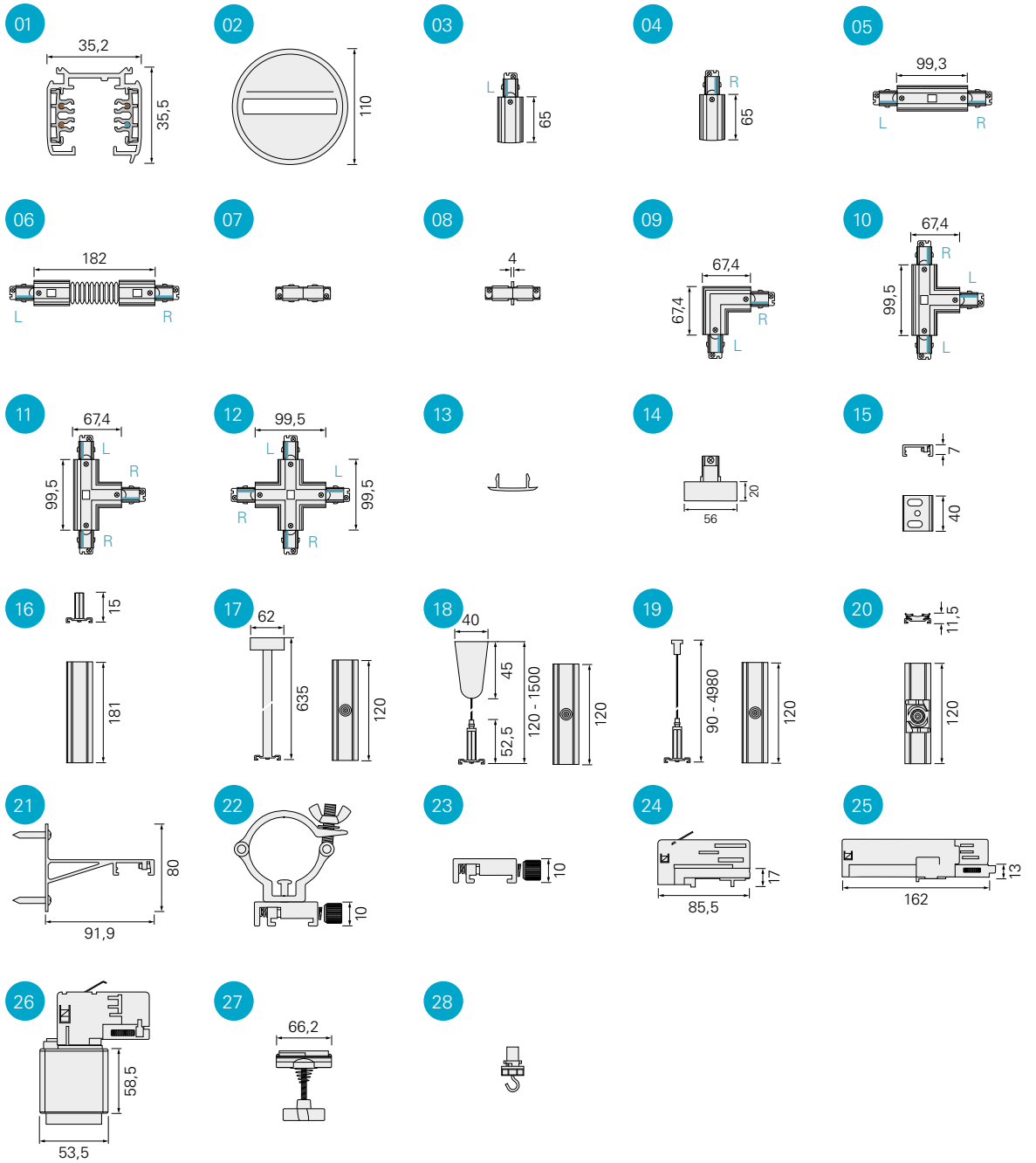

D LINE BUILT IN POWER RAIL SYSTEM 3-PHASE 230V

built in modules	illustr.	white	illustr.	cover	page
built in power rail L: 1000 mm	01	710069		-	302
built in power rail L: 2000 mm	01	710070		-	302
built in power rail L: 3000 mm	01	710071		-	302
electric feeder left side	02	710009	19	710089	304
electric feeder right side	03	710012	19	710089	304
electrical straight connector with center feed option	04	710042	20	710090	305
electrical joint	05	710015		-	306
mechanical joint	06	710018		-	306
90°-joint left-right	07	710036	21	710091	307
T-joint left-left-right	08	710027	22	710093	308
T-joint right-right-left	09	710030	22	710093	308
X-joint left-left-right-right	10	710033	23	710092	309
cover plate built in track	11	710077			310
endcap	12	710103		-	310
D Line/Dali quick-mounting bracket for recessed rail	13	710107			307
3-circuits adapter for light installation	14	710097		-	318
3-circuits adapter with Multi CC power supply 250/350/450/500 mA 6,30 - 21,00 W 25-42V	15	862180			319
3-circuits adapter with Multi CC power supply 600/700/750/800 mA 15,00 - 33,60 W 25-42V	15	862181			319
3-circuits adapter with Multi CC power supply 850/900/950/1050 mA 23,00 - 44,10 W 27-42V	15	862182			319
electrical outlet adapter	16	710024		-	320
mounting adapter for additional components max. 10kg	17	710054		-	320
signs hook, max. load 5kg	18	710060		-	321



710033



710092

Unlike other systems, you will not need any additional or special electrical components such as feeders, connectors, corners or T-connectors for the recessed tracks in the future. All standard components of the system are used and only the matching plastic cover is exchanged, and the recessed version is ready. This simplifies stock-keeping and gives significantly more flexibility here as well.

ILLUSTRATIONS WITH PLANNING-WRELEVANT DIMENSIONS

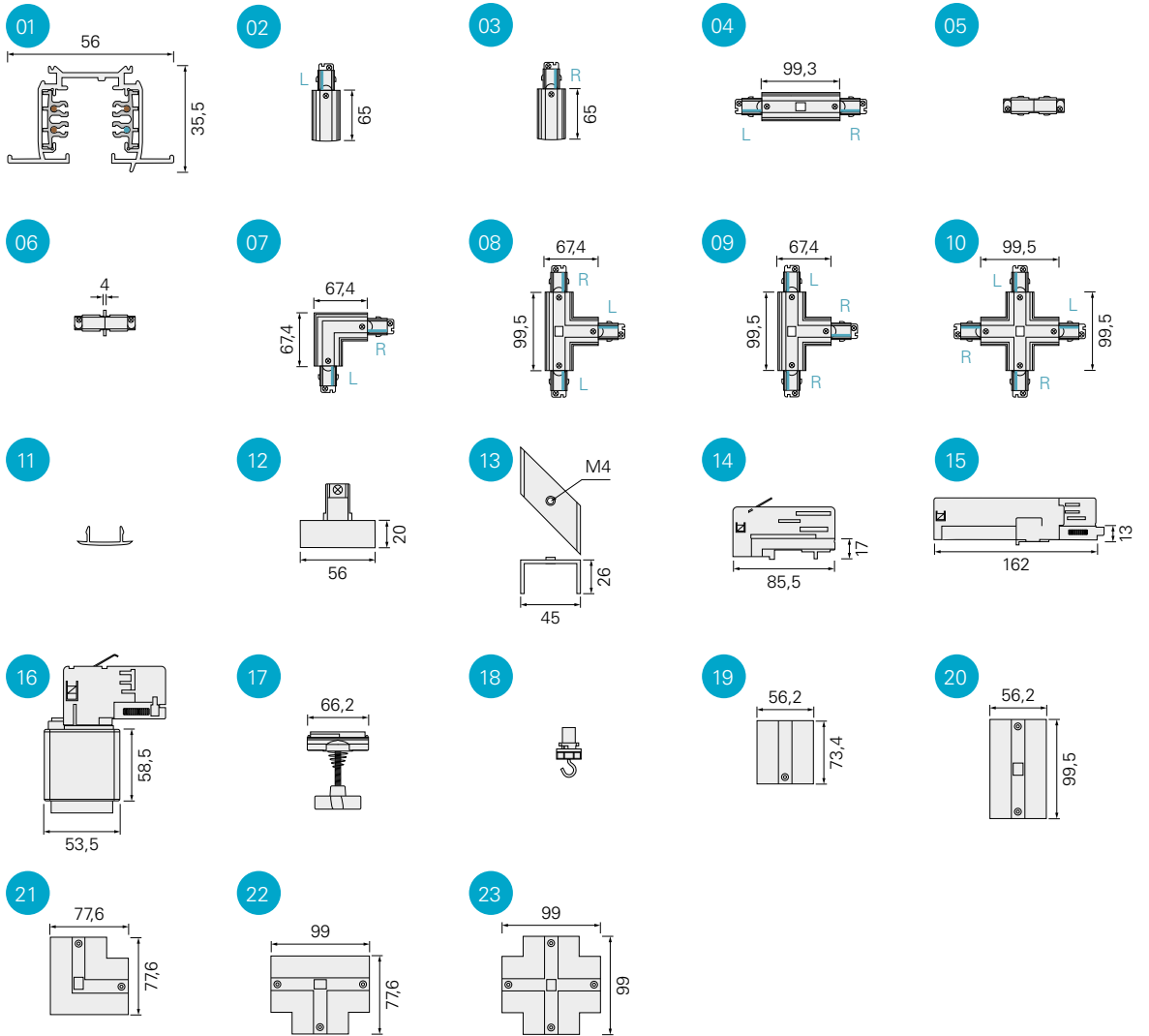

FIXING POINTS

power rail	a	b	c	d
1000 mm	125 mm			
2000 mm	125 mm	998 mm		
3000 mm	125 mm		914 mm	1167 mm

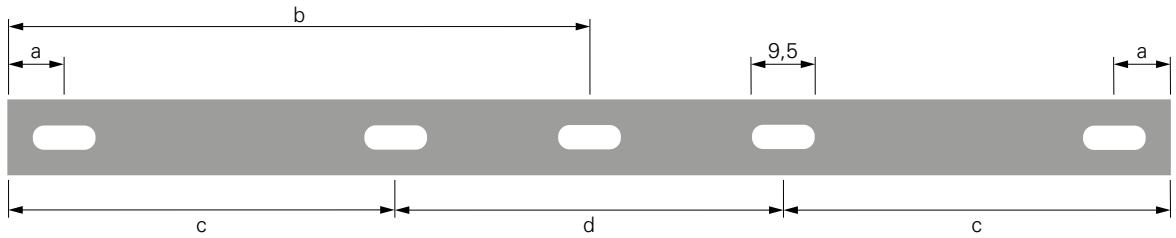

MECHANICAL LOAD TRACK POWER RAIL 1000 MM

50 N $\hat{=}$ 5,09 kg
dimension in mm

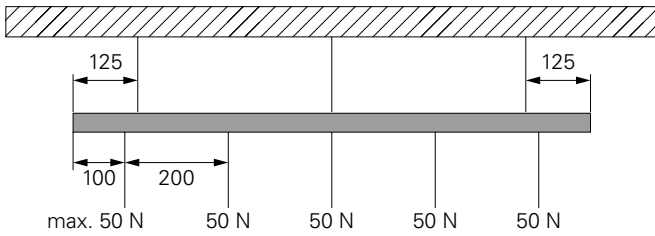

MECHANICAL LOAD TRACK POWER RAIL 2000/3000 MM

50 N $\hat{=}$ 5,09 kg
dimension in mm

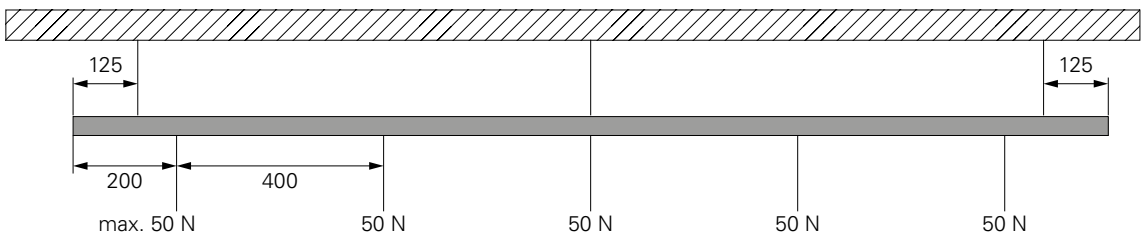

PLANNING GUIDE D LINE MOUNTING POWER RAIL SYSTEM 3-PHASE 230V

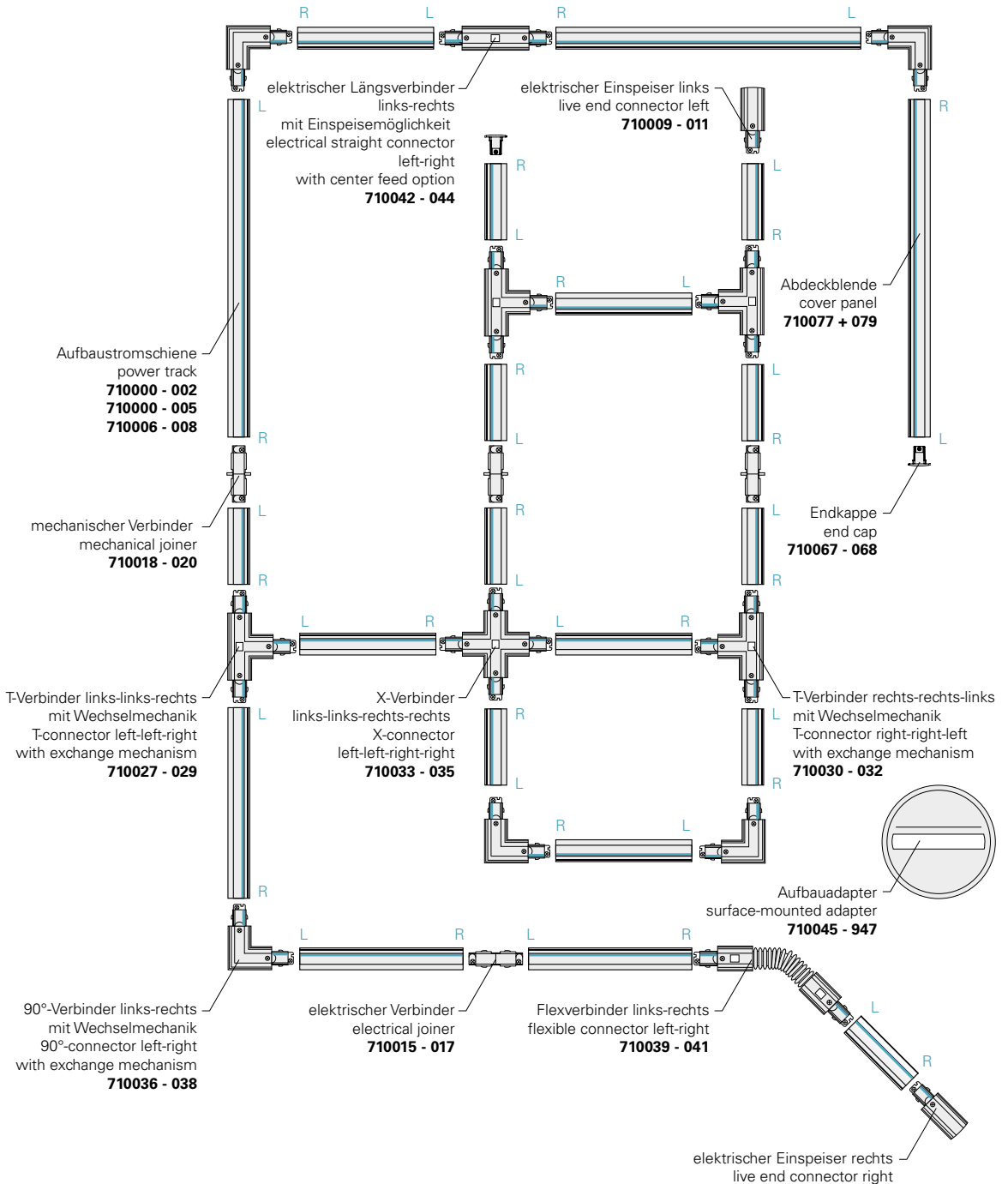
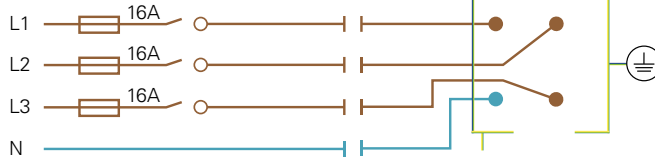
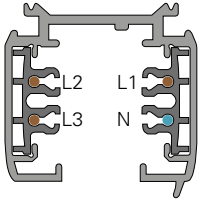

D LINE POWER RAIL SYSTEM 3-PHASE 230V

The D LINE track system is available exclusively from DEKO-LIGHT and is extremely easy to plan and install thanks to its components, some of which have been completely redesigned. It is also compatible with all common track adapters and luminaires. The elegant and timeless design is available in white, black and grey, and the wide range

of accessories and mounting components means that there are no limits to its use and installation. Thanks to the interchangeable mechanism of the 90° and T connectors, planning is easier than ever before and the installation of even complex shapes will be child's play in the future.

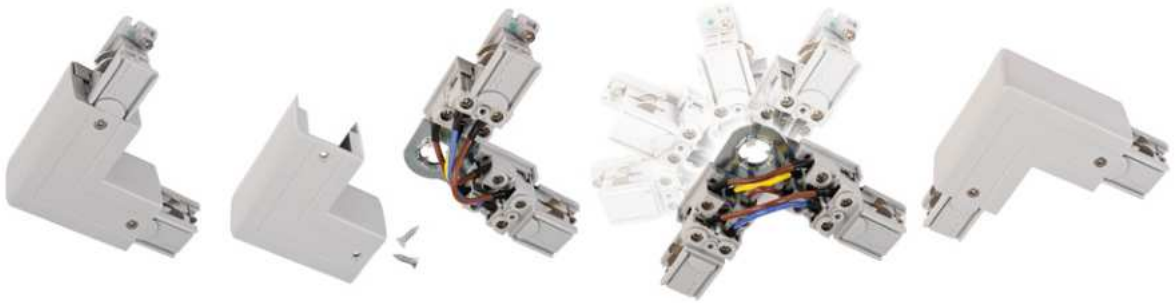

COMPATIBILITY OVERVIEW

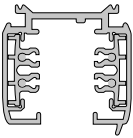
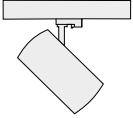
power rail	luminaires and power rail adapters from:						
D LINE	D LINE	Global	Ivela	Erco	Hoffmeister	Zumtobel/ Staff	Eutrac
	compatible	compatible	compatible	compatible	compatible	compatible	compatible
luminaires	3-phase power rail from:						
DEKO-LIGHT	D LINE	Global	Ivela	Erco	Hoffmeister	Zumtobel/ Staff	Eutrac
	compatible	compatible*	compatible*	compatible*	compatible*	compatible*	compatible*

*compatible with all DEKO-LIGHT 3-phase spotlights, except ALNITAK series [S. 354] and 3-phase adapter with integrated multi-CC power supply [S. 319].

All data without guarantee. Technical data and dimensions are subject to change without prior notice. Check against samples when planning a project to ensure functionality.

With the kind support of WIBU-SYSTEMS AG Karlsruhe



On request, all D LINE busbars can be supplied ready-made and cut to size according to your specifications for a small surcharge. This allows you to start installation directly on site at the customer's premises. Please contact our sales department for more information.



with the kind support of Salvia Elektrotechnik GmbH

D LINE SURFACE-MOUNTED POWER TRACK

The D LINE busbar system is available exclusively from DE-KO-LIGHT and is extremely easy to plan and install thanks to some of the components having been fully redesigned. It is also compatible with all common busbar adapters and lights. The elegant and timeless design is available in white, black and grey and with a huge range of accessories and assembly components available, the possibilities are almost endless when it comes to application and installation. The reversal mechanism of the 90° and T-connectors makes planning simpler than ever before and in the future installing even complex shapes will be a breeze.



D LINE SURFACE-MOUNTED POWERTRACK

- up to three phases can be fed in
- several different attachment options

Housing	Aluminium	Height	35.5 mm
Mounting Type	Top mounting	Rated Input Voltage	220-240 V/AC
Width	35.2 mm	Output Current	16 A

Article	Housing Color	Length	Price
710000	<input type="checkbox"/> White	1000 mm	€ 44.95
710001	<input type="checkbox"/> Grey	1000 mm	€ 44.95
710002	<input type="checkbox"/> Black	1000 mm	€ 44.95
710003	<input type="checkbox"/> White	2000 mm	€ 89.95
710004	<input type="checkbox"/> Grey	2000 mm	€ 89.95
710005	<input type="checkbox"/> Black	2000 mm	€ 89.95
710006	<input type="checkbox"/> White	3000 mm	€ 129.95
710007	<input type="checkbox"/> Grey	3000 mm	€ 129.95
710008	<input type="checkbox"/> Black	3000 mm	€ 129.95



Lighting design

Interested in our lighting design service?

Your contact person will be happy to answer any questions you may have.



D LINE BUILT-IN POWER TRACK

- Up to 3 phases (3x 16A) can be fed in
- Suitable for recessed system
- side wings for optimum ceiling installation

Housing	Aluminium	Height	35.5 mm
Mounting Type	Top mounting	Rated Input Voltage	220-240 V/AC
Width	56 mm	Output Current	16 A

Article	Housing Color	Length	Price
710069	<input type="checkbox"/> White	1000 mm	€ 54.95
710070	<input type="checkbox"/> White	2000 mm	€ 99.95
710071	<input type="checkbox"/> White	3000 mm	€ 144.95



D LINE QUICK-MOUNTING BRACKET FOR INSTALLATION RAIL

- Suitable for installation system
- to simplify the installation of recessed conductor rails
- no additional substructures required for fastening

Housing	Steel	Length	70 mm
Mounting Type	Installation mounting	Width	45 mm
		Height	25 mm

Article	Housing Color	Price
710107	<input type="checkbox"/> Silver	€ 4.95





D LINE SURFACE-MOUNTED ADAPTER

- Surface-mounted housing for converting track spotlights
- 1 phase (1x 16A) can be fed in
- Simple installation

Housing	Plastic	Ø	110 mm
Mounting Type	Top mounting	Rated Input Voltage	220-240 V/AC
Height	35 mm	Output Current	16 A

Article	Housing Color	Price
710045	<input type="checkbox"/> White	€ 29.95
710046	<input type="checkbox"/> Grey	€ 29.95
710047	<input type="checkbox"/> Black	€ 29.95



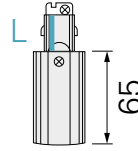

D LINE ELECTRIC FEEDER LEFT

- up to three phases can be fed in
- Power supply possible from above [ceiling] or from the side
- suitable for surface-mounted and recessed systems

Housing	Plastic	Height	35.5 mm
Mounting Type	Top mounting	Rated Input Voltage	220-240 V/AC
Length	98.5 mm	Output Current	16 A
Width	35.2 mm		

Article	Housing Color	Price
710009	<input type="checkbox"/> White	€ 15.95
710010	<input type="checkbox"/> Grey	€ 15.95
710011	<input type="checkbox"/> Black	€ 15.95

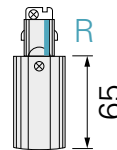

D LINE ELECTRICAL FEEDER RIGHT

- up to three phases can be fed in
- Power supply possible from above [ceiling] or from the side
- suitable for surface-mounted and recessed systems

Housing	Plastic	Height	35.5 mm
Mounting Type	Top mounting	Rated Input Voltage	220-240 V/AC
Length	98.5 mm	Output Current	16 A
Width	35.2 mm		

Article	Housing Color	Price
710012	<input type="checkbox"/> White	€ 15.95
710013	<input type="checkbox"/> Grey	€ 15.95
710014	<input type="checkbox"/> Black	€ 15.95



Accessories

710089 D Line cover panel feed left/right



€ 3.95



D LINE ELECTRICAL LONGITUDINAL CONNECTOR WITH FEED OPTION

- Up to three phases can be fed in
- Cable feed from the ceiling
- Suitable for surface-mounted and recessed systems

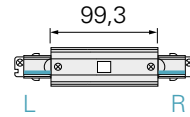

Housing	Plastic	Height	35.5 mm
Mounting Type	Top mounting	Rated Input Voltage	220-240 V/AC
Length	166 mm	Output Current	16 A
Width	35 mm		

Article	Housing Color	Price
710042	<input type="checkbox"/> White	€ 32.95
710043	<input type="checkbox"/> Grey	€ 32.95
710044	<input type="checkbox"/> Black	€ 32.95



Accessories

710090 D Line/Dali cover panel for longitudinal connector



€ 3.95



D LINE FLEX CONNECTOR LEFT-RIGHT

- Simple assembly
- Compensates for different height levels or angles
- suitable for superstructure system

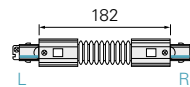

Housing	Plastic	Height	35.5 mm
Mounting Type	Top mounting	Rated Input Voltage	220-240 V/AC
Length	248 mm	Output Current	16 A
Width	35 mm		

Article	Housing Color	Price
710039	<input type="checkbox"/> White	€ 42.95
710040	<input type="checkbox"/> Grey	€ 42.95
710041	<input type="checkbox"/> Black	€ 42.95





D LINE ELECTRIC CONNECTOR

·suitable for surface-mounted and recessed systems

Housing	Plastic	Height	26.5 mm
Mounting Type	Top mounting	Rated Input Voltage	220-240 V/AC
Length	68 mm	Output Current	16 A
Width	20.5 mm		

Article	Housing Color	Price
710015	<input type="checkbox"/> White	€ 9.95
710016	<input type="checkbox"/> Grey	€ 9.95
710017	<input type="checkbox"/> Black	€ 9.95



D LINE MECHANICAL CONNECTOR

·Mechanical connector without electrical contacts
 ·for electrical isolation of 2 different circuits within a track system
 ·suitable for surface-mounted and built-in systems

Housing	Plastic	Width	20 mm
Mounting Type	Top mounting	Height	27 mm
Length	66.4 mm		

Article	Housing Color	Price
710018	<input type="checkbox"/> White	€ 6.95
710019	<input type="checkbox"/> Grey	€ 6.95
710020	<input type="checkbox"/> Black	€ 6.95



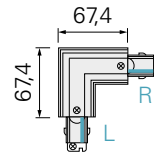
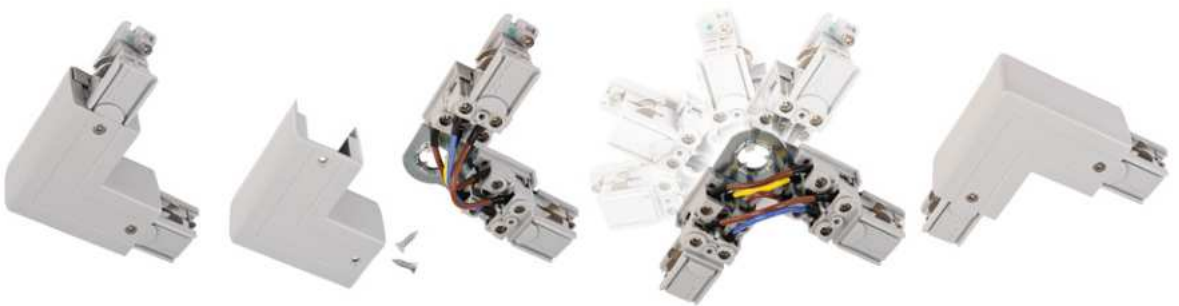

D LINE 90° CONNECTOR LEFT-RIGHT WITH REVERSAL MECHANISM

- with interchangeable mechanism for changing direction L/R
- Suitable for surface-mounted and recessed systems

Housing	Plastic	Height	35.5 mm
Mounting Type	Top mounting	Rated Input Voltage	220-240 V/AC
Length	100.7 mm	Output Current	16 A
Width	100.7 mm		

Article	Housing Color	Price
710036	<input type="checkbox"/> White	€ 34.95
710037	<input type="checkbox"/> Grey	€ 34.95
710038	<input type="checkbox"/> Black	€ 34.95



Accessories

710091 D Line/Dali cover panel for 90° connector



€ 3.95



D LINE T-CONNECTOR LEFT-LEFT-RIGHT WITH REVERSAL MECHANISM

- with reversal mechanism for switching the orientation between left / right
- easy to install
- suitable for surface-mounted and recessed systems

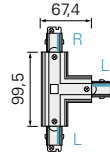

Housing	Plastic	Height	35.5 mm
Mounting Type	Top mounting	Rated Input Voltage	220-240 V/AC
Length	166 mm	Output Current	16 A
Width	101 mm		

Article	Housing Color	Price
710027	<input type="checkbox"/> White	€ 49.95
710028	<input type="checkbox"/> Grey	€ 49.95
710029	<input type="checkbox"/> Black	€ 49.95

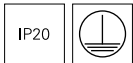

D LINE T-CONNECTOR RIGHT/RIGHT/LEFT WITH EXCHANGE MECHANICS

- with reversal mechanism for switching the orientation between left / right
- easy to install
- suitable for surface-mounted and recessed systems

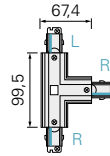

Housing	Plastic	Height	35.5 mm
Mounting Type	Top mounting	Rated Input Voltage	220-240 V/AC
Length	166 mm	Output Current	16 A
Width	101 mm		

Article	Housing Color	Price
710030	<input type="checkbox"/> White	€ 49.95
710031	<input type="checkbox"/> Grey	€ 49.95
710032	<input type="checkbox"/> Black	€ 49.95



Accessories

710093 D Line/Dali cover panel for T-connector



€ 3.95



D LINE X-CONNECTOR LEFT-LEFT-RIGHT-RIGHT

- Simple installation
- Suitable for surface-mounted and built-in systems

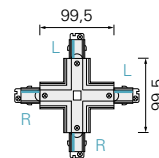

Housing	Plastic	Height	35.5 mm
Mounting Type	Top mounting	Rated Input Voltage	220-240 V/AC
Length	166 mm	Output Current	16 A
Width	166 mm		

Article	Housing Color	Price
710033	<input type="checkbox"/> White	€ 66.95
710034	<input type="checkbox"/> Grey	€ 66.95
710035	<input type="checkbox"/> Black	€ 66.95



Accessories

710092 D Line/Dali cover panel for X-connector



€ 4.95



D LINE COVER PANEL

- Suitable for surface-mounted and recessed systems
- for closing publicly accessible conductor rails within a contact zone of less than 2.30 m

Housing	Plastic	Width	21.5 mm
Mounting Type	Top mounting	Height	7.5 mm
Length	1000 mm		

Article	Housing Color	Price
710077	White	€ 5.95
710079	Black	€ 5.95



D LINE END CAP

- For closing open busbar ends (contact hazard protection)
- Simple installation
- Suitable for surface-mounted system

Housing	Plastic	Height	32.5 mm
---------	---------	--------	---------

Article	Housing Color	Mounting Type	Length	Width	Price
710066	White	Top mounting	31.3 mm	35.2 mm	€ 2.95
710067	Grey	Top mounting	31.3 mm	35.2 mm	€ 2.95
710068	Black	Top mounting	31.3 mm	35.2 mm	€ 2.95
710103	White	Installation mounting	56 mm	47.9 mm	€ 2.95
710538	Black	Installation mounting	56 mm	47.9 mm	€ 2.95



D LINE MOUNTING BRACKET FLEX

- Suitable for surface-mounted system
- Simplifies the assembly of more complex shapes
- Conductor rail remains „movable“ during installation

Housing	Metal	Width	33.8 mm
Mounting Type	Top mounting	Height	12.5 mm
Length	40 mm		

Article	Housing Color	Price
710063	<input type="checkbox"/> White	€ 5.95
710064	<input type="checkbox"/> Grey	€ 5.95
710065	<input type="checkbox"/> Black	€ 5.95



D LINE WALL BRACKET

- Suitable for surface-mounted system
- Simplifies the installation of track close to the wall
- Ideal for illuminating pictures and objects, e.g. in exhibitions, collections, museums, etc.

Housing	Aluminium	Width	25 mm
Mounting Type	Top mounting	Height	80 mm
Length	91.9 mm		

Article	Housing Color	Price
710104	<input type="checkbox"/> White	€ 14.95
710105	<input type="checkbox"/> Grey	€ 14.95
710106	<input type="checkbox"/> Black	€ 14.95

IP20



D LINE SUSPENSION CONNECTION BRACKET

- Suitable for surface-mounted system
- for chain mounting or similar (chain not included)

Housing	Metal	Width	32 mm
Mounting Type	Top mounting	Height	20 mm
Length	181 mm		

Article	Housing Color	Price
710057	<input type="checkbox"/> White	€ 9.95
710058	<input type="checkbox"/> Grey	€ 9.95
710059	<input type="checkbox"/> Black	€ 9.95

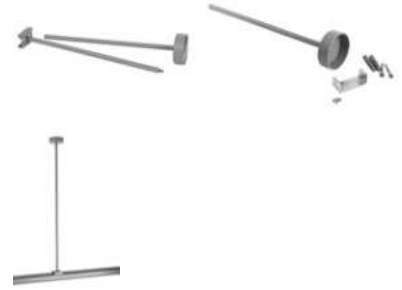

D LINE CEILING SUSPENSION RIGID

- Stable and elegant suspension
- Suitable for surface-mounted system
- Suspension dimension 635 mm (can be shortened to 335 mm)
- Suspension dimension can be extended using accessories

Housing	Aluminium	Length	635 mm
Mounting Type	Top mounting	Width	60 mm

Article	Housing Color	Price
710078	<input type="checkbox"/> White	€ 32.95
710084	<input checked="" type="checkbox"/> Black	€ 32.95
710085	<input type="checkbox"/> Grey	€ 32.95



D LINE EXTENSION FOR CEILING SUSPENSION RIGID

- Suitable for rigid ceiling suspension
- increases the suspension dimension by 300 mm in each case

Housing	Aluminium	Length	310 mm
Mounting Type	Top mounting	Width	10 mm

Article	Housing Color	Price
710086	<input type="checkbox"/> White	€ 5.95
710087	<input checked="" type="checkbox"/> Black	€ 5.95
710088	<input type="checkbox"/> Grey	€ 5.95



D LINE ROPE SUSPENSION BRACKET

- Can be cut to length for suspension dimension: 120-1,500 mm
- suitable for surface-mounted systems

Housing	Metal	Width	31 mm
Mounting Type	Top mounting	Height	52 mm
Length	120 mm		

Article	Housing Color	Price
710048	<input type="checkbox"/> White	€ 14.95
710049	<input type="checkbox"/> Grey	€ 14.95
710050	<input type="checkbox"/> Black	€ 14.95

Accessories

710081 D Line/Dali cable for cable suspension 4.0 m



€ 7.95



D LINE ROPE SUSPENSION BRACKET MINI

- Elegant and filigree suspension
- Suspension dimensions can be individually shortened: 90-4960 mm
- Suitable for surface-mounted system

Housing	Metal	Width	31 mm
Mounting Type	Top mounting	Height	58 mm
Length	120 mm		

Article	Housing Color	Price
710094	<input type="checkbox"/> White	€ 19.95
710095	<input type="checkbox"/> Grey	€ 19.95
710096	<input type="checkbox"/> Black	€ 19.95



D LINE FAST-MOUNTING BRACKET

- Suitable for surface-mounted system
- conductor rail is fixed without tools using knurled screw and spring clip fixed in place
- Quick installation and removal, e.g. in exhibition stand construction

Housing	Aluminium	Width	30 mm
Mounting Type	Top mounting	Height	11.9 mm
Length	40 mm		

Article	Housing Color	Price
710082	■ Black	€ 10.95



D LINE TRUSS ADAPTER

- Suitable for surface-mounted system
- Quick-release fasteners for fast mounting of conductor rails on truss structures
- Suitable for all 50 mm aluminium trusses in event technology / trade fair construction

Housing	Aluminium	Width	30 mm
Mounting Type	Top mounting	Height	11.9 mm
Length	40 mm		

Article	Housing Color	Price
710083	■ Silver	€ 29.95



This little »jack-of-all-trades« makes mounting a track on an existing grid ceiling child's play. The installation time is only a fraction of what it used to be. In the first step, the clip is simply clicked into the visible metal strips of the grid ceiling and is held bomb-proof on the ceiling by means of a safety spring clip. After that, the conductor rail is simply pushed onto it and the installation is finished.





D LINE GRID CEILING FAST-MOUNTING BRACKET

- Suitable for surface-mounted system
- Quick and easy installation on grid ceilings
- mechanical load up to 15.0 kg / 150N
- suitable for 22-24mm grid ceiling support rails

Housing	Metal	Width	31 mm
Mounting Type	Top mounting	Height	11 mm
Length	120 mm		

Article	Housing Color	Price
710051	<input type="checkbox"/> White	€ 11.95
710052	<input type="checkbox"/> Grey	€ 11.95
710053	<input type="checkbox"/> Black	€ 11.95





D LINE 3-PHASE ADAPTER FOR LIGHT INSTALLATION

- Suitable for surface-mounted and recessed systems
- incl. trumpet nipple, M10 flat nut and strain relief grommet
- Simple installation
- Integrated secondary fall protection
- Load capacity max. 10 kg / 100 N

Housing	Plastic	Height	54 mm
Mounting Type	Top mounting	Rated Input Voltage	220-240 V/AC
Length	84 mm	Output Current	10 A
Width	32 mm		

Article	Housing Color	Price
710097	<input type="checkbox"/> White	€ 18.95
710098	<input type="checkbox"/> Grey	€ 18.95
710099	<input type="checkbox"/> Black	€ 18.95





D LINE THREE-PHASE ADAPTER WITH INTEGRATED MULTI CC POWER SUPPLY

- Suitable for surface-mounted and recessed systems
- Integrated secondary fall protection
- Supplied with trumpet nipple and M10 flat nut
- integrated, adjustable, current-stable power supply unit [CC]
- Check suitability of the intended luminaire
- max. 10kg / 100N
- exclusively for 3-phase track from D LINE, Ivela, Hoffmeister

Housing	Plastic	Height	41 mm
Length	162 mm	Rated Input Voltage	220-240 V/AC
Width	31 mm	Mounting Location	Inside

Article		Output Current Selectable	Power	Output Voltage	Price
862180	<input type="checkbox"/>	250 mA / 350 mA / 450 mA / 500 mA	6.2-21.0 W	25-42 V/DC	€ 32.95
862183	<input checked="" type="checkbox"/>	250 mA / 350 mA / 450 mA / 500 mA	6.2-21.0 W	25-42 V/DC	€ 32.95
862181	<input type="checkbox"/>	600 mA / 700 mA / 750 mA / 800 mA	15.0-33.0 W	25-42 V/DC	€ 35.95
862184	<input checked="" type="checkbox"/>	600 mA / 700 mA / 750 mA / 800 mA	15.0-33.0 W	25-42 V/DC	€ 35.95
862182	<input type="checkbox"/>	850 mA / 900 mA / 950 mA / 1050 mA	22.0-44.0 W	27-42 V/DC	€ 37.95
862185	<input checked="" type="checkbox"/>	850 mA / 900 mA / 950 mA / 1050 mA	22.0-44.0 W	27-42 V/DC	€ 37.95





D LINE SOCKET ADAPTER

- easy to install
- suitable for surface-mounted and recessed systems
- as power distribution system in current tracks
- max. 1,380 W
- integrated plug fuse

Housing	Plastic	Width	53.5 mm
Mounting Type	Top mounting, Installation mounting	Height	103 mm
Length	58.5 mm	Rated Input Voltage	230 V/AC
		Output Current	6 A

Article	Housing Color	Price
710024	White	€ 28.95
710025	Grey	€ 28.95
710026	Black	€ 28.95

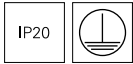

D LINE MOUNTING ADAPTER FOR ADDITIONAL COMPONENTS

- Suitable for surface-mounted and recessed systems
- Mounting adapter (M6 thread) as holder for additional devices and lights
- perfect use in conjunction with optional D Line socket outlet adapter
- max. load 10kg / 100N

Housing	Metal, Plastic	Width	31.5 mm
Mounting Type	Top mounting	Height	84 mm
Length	66.5 mm		

Article	Housing Color	Price
710054	White	€ 10.95
710055	Grey	€ 10.95
710056	Black	€ 10.95



D LINE SIGN HOOK

- Suitable for surface-mounted and recessed systems
- Hook for attaching information signs etc.
- Load max. 5kg / 50N

Housing	Plastic	Height	52 mm
Mounting Type	Top mounting	Ø	25 mm

Article	Housing Color	Price
710060	□ White	€ 2.95
710061	■ Grey	€ 2.95
710062	■ Black	€ 2.95

D LINE DALI system



□ ■ ●
page 339



□ ■ ●
page 339



□ ■ ●
page 340



□ ■ ●
page 341



□ ■ ●
page 341



□ ■ ●
page 342



□ ■ ●
page 342



□ ■ ●
page 345



□ ■ ●
page 346



□ ■ ●
page 347



□ ■ ●
page 347



□
page 331



page 334



page 330



page 330



page 331



page 332



page 332



page 333



page 333



page 334



page 335



page 336



page 336



page 337

D LINE DALI MOUNTING POWER RAIL SYSTEM 3-PHASE 230V

mounting modules	illustr.	white	black	page
mounting power rail L: 1000 mm	01	710500	710501	330
mounting power rail L: 2000 mm	01	710502	710503	330
mounting power rail L: 3000 mm	01	710504	710505	330
mounting adapter for lights	02	710512	710513	330
live end feeder left	03	710514	710515	332
live end feeder right side	04	710516	710517	332
electrical straight connector with center feed option	05	710520	710521	333
flexible-connector left-right side	06	710523	710524	333
electrical joint	07	710525	710526	334
mechanical joint	08	710018	710020	334
90°-joint left-right with exchange mechanism	09	710527	710528	335
T-joint left-left-right with exchange mechanism	10	710530	710531	336
T-joint right-right-left with exchange mechanism	11	710532	710533	336
X-joint left-left-right-right	12	710535	710536	337
cover plate	13	710077	710079	338
endcap	14	710066	710068	338
ceiling mounting bracket flex	15	710063	710065	339
suspension clamp for track connection	16	710057	710059	340
ceiling suspension rigid [635 mm] with canopy	17	710078	710084	341
extension for ceiling suspension [300 mm]	17	710086	710087	341
wire suspension bracket with ceiling rosette 1500 mm	18	710048	710050	342
rope suspension bracket Mini mit Abhängeseil 5000 mm	19	710094	710096	342
quick mounting bracket for grid ceilings	20	710051	710053	345
wall bracket	21	710104	710106	339
truss adapter silver coloured	22	710083	710083	343
quick mounting clamp for exhibition stand construction	23	-	710082	343
3-circuits adapter for light installation	24	710539	710540	346
electrical outlet adapter	25	710024	710026	346
mounting adapter for additional components max. 10kg	26	710054	710056	347
signs hook, max. load 5kg	27	710060	710062	347

ILLUSTRATIONS WITH PLANNING RELEVANT DIMENSIONS

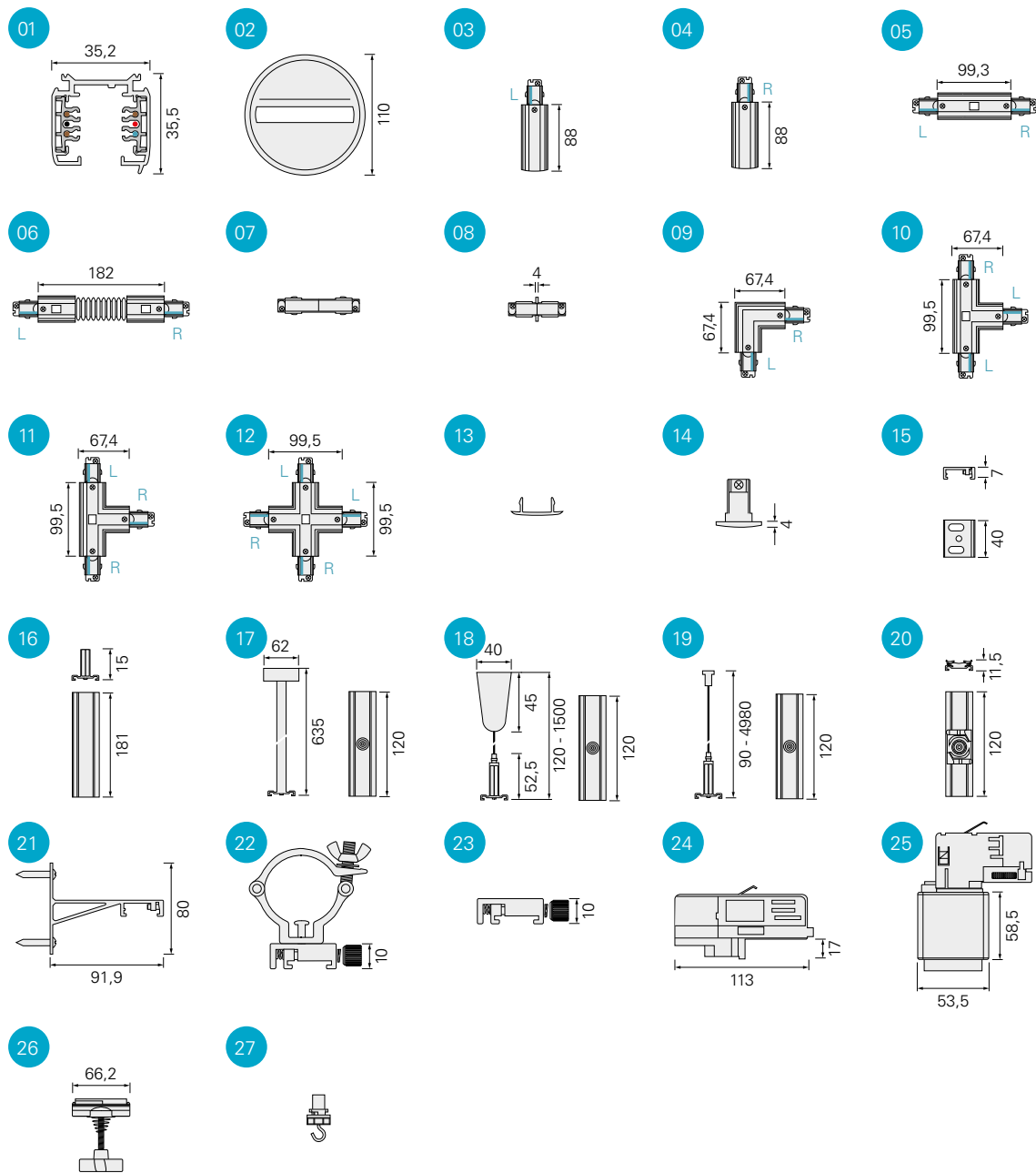

D LINE DALI BUILT IN POWER RAIL SYSTEM 3-PHASE 230V

built in modules	illustr.	white	cover	black	cover	page
built in power rail L: 1000 mm	01	710506	-	710507	-	331
built in power rail L: 2000 mm	01	710508	-	710509	-	331
built in power rail L: 3000 mm	01	710510	-	710511	-	331
electric feeder left side	02+18	710514	710518	710515	710519	332
electric feeder right side	03+18	710516	710518	710517	710519	332
electrical straight connector with center feed option	04+19	710520	710090	710521	710522	333
electrical joint	05	710525	-	710526	-	334
mechanical joint	06	710018	-	710020	-	334
90°-joint left-right	07+20	710527	710091	710528	710529	335
T-joint left-left-right	08+21	710530	710093	710531	710534	336
T-joint right-right-left	09+21	710532	710093	710533	710534	336
X-joint left-left-right-right	10+22	710535	710092	710536	710537	337
cover plate	11	710077	-	710079	-	338
endcap	12	710103	-	710538	-	338
D Line/Dali quick-mounting bracket for recessed rail	13	710107	-	-	-	331
3-circuits adapter for light installation	14	710539	-	710540	-	346
electrical outlet adapter	15	710024	-	710026	-	346
mounting adapter for additional components max. 10kg	16	710054	-	710056	-	347
signs hook, max. load 5kg	17	710060	-	710062	-	347



Unlike other DALI systems, you do not need any additional or special electrical components such as feeders, connectors, corners or T-connectors for the recessed tracks. All the standard components of the system are used and only the matching plastic cover is replaced; the recessed version is ready. This simplifies stock-keeping and also provides significantly more flexibility.



ILLUSTRATIONS WITH PLANNING RELEVANT DIMENSIONS

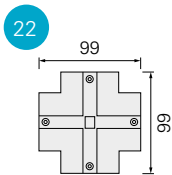
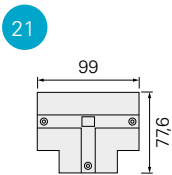
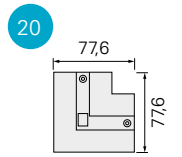
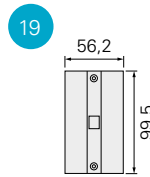
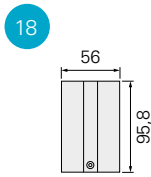
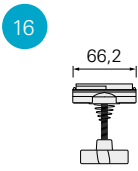
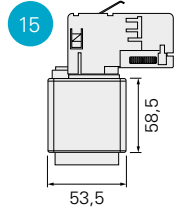
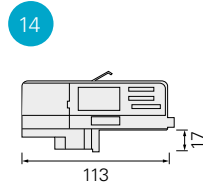
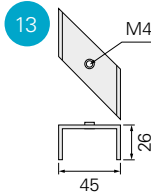
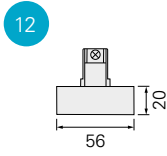
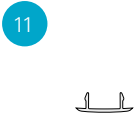
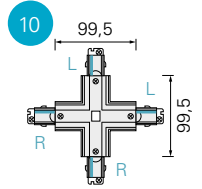
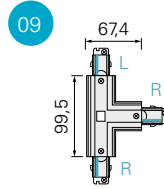
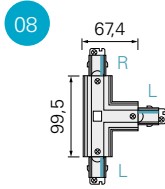
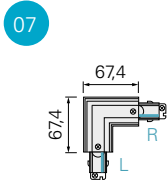
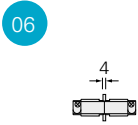
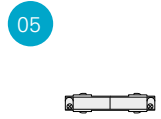
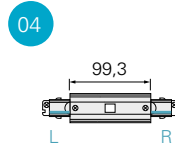
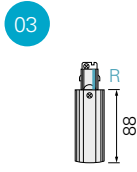
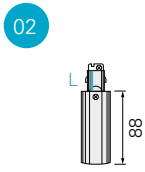
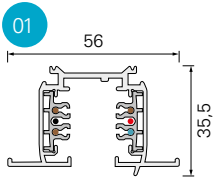

FIXING POINTS

power rail	a	b	c	d
1000 mm	125 mm			
2000 mm	125 mm	995 mm		
3000 mm	125 mm		914 mm	1172 mm

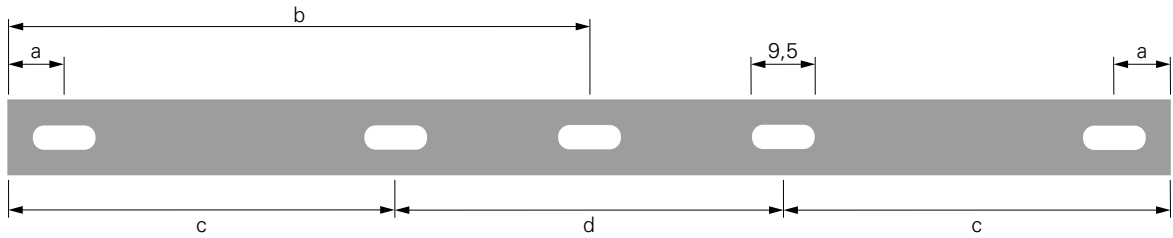

MECHANICAL LOAD TRACK POWER RAIL 1000 MM

60 N \approx 6,12 kg
dimension in mm

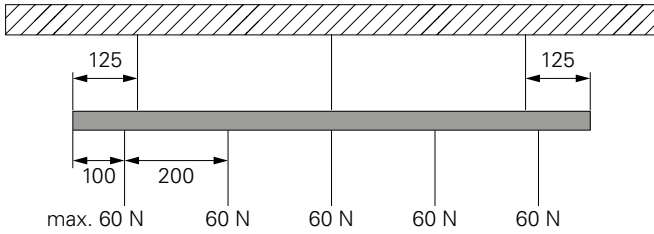

MECHANICAL LOAD TRACK POWER RAIL 2000/3000 MM

30 N \approx 3,06 kg
dimension in mm

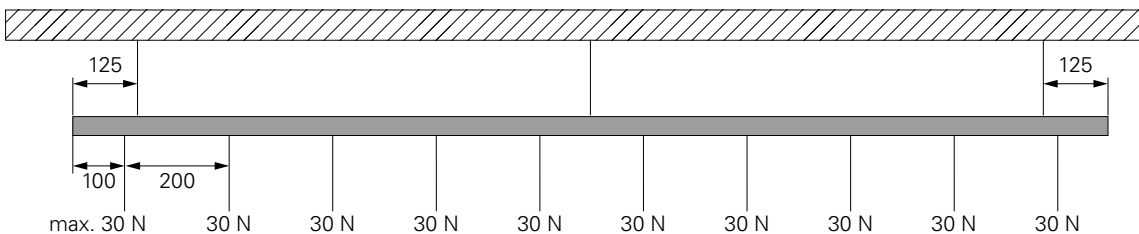

PLANNING GUIDE D LINE DALI MOUNTING POWER RAIL SYSTEM

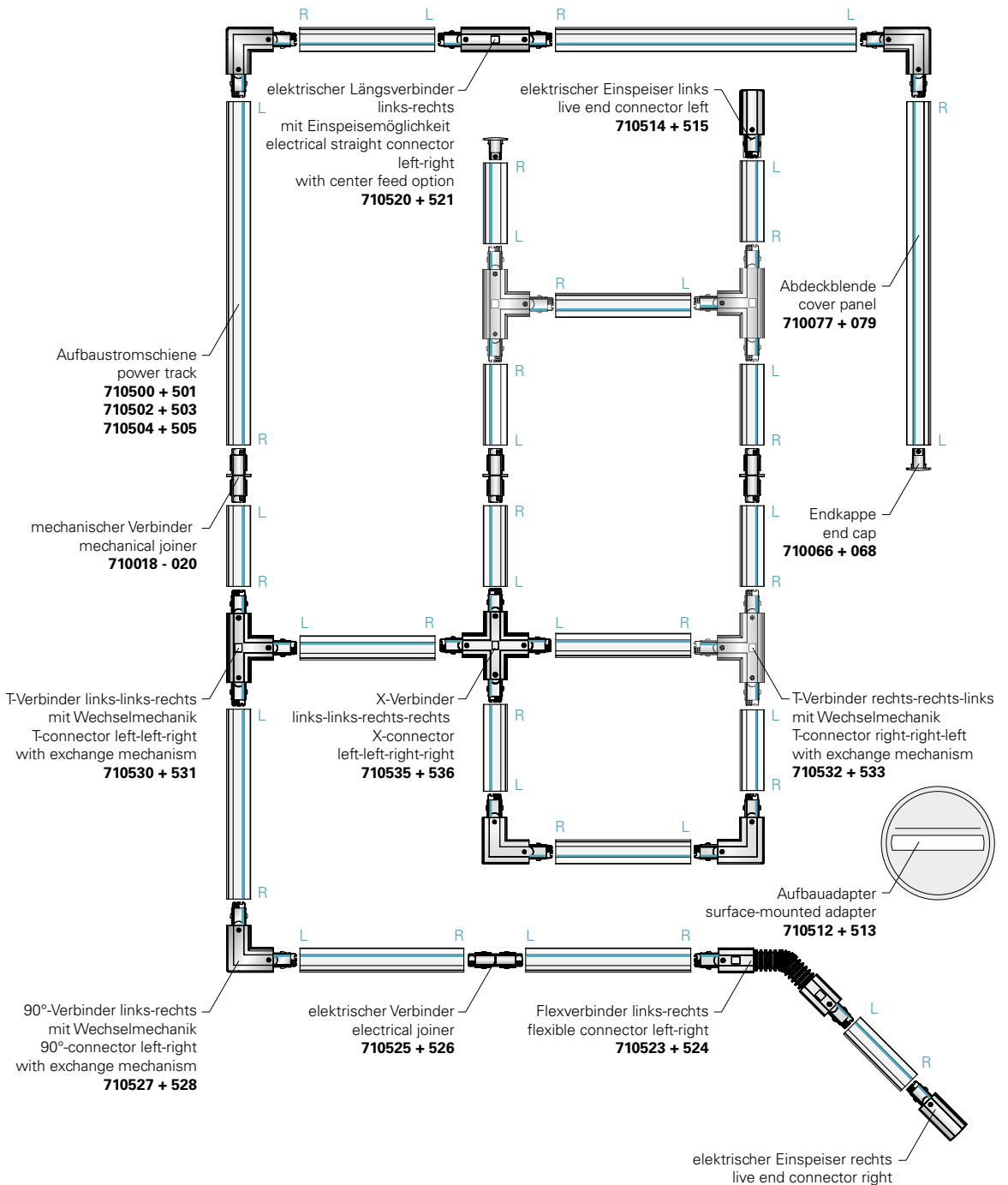
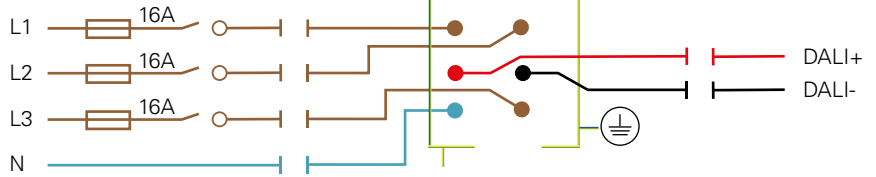
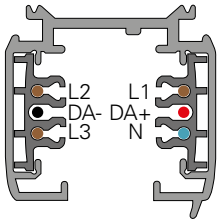



D LINE DALI SURFACE-MOUNTED POWERTRACK

- Controllable with DALI
- up to 3 phases (3x 16A) can be fed in
- Many different mounting options

Housing	Aluminium	Rated Input Voltage	220-240 V/AC
Width	35.2 mm	Output Current	16 A
Height	35.5 mm		

Article	Housing Color	Length	Price
710500	<input type="checkbox"/> White	1000 mm	€ 48.95
710501	<input checked="" type="checkbox"/> Black	1000 mm	€ 48.95
710502	<input type="checkbox"/> White	2000 mm	€ 92.95
710503	<input checked="" type="checkbox"/> Black	2000 mm	€ 92.95
710504	<input type="checkbox"/> White	3000 mm	€ 134.95
710505	<input checked="" type="checkbox"/> Black	3000 mm	€ 134.95



D LINE DALI SURFACE-MOUNTED ADAPTER

- Controllable with DALI
- Surface-mounted housing for converting track spotlights
- 1 phase (1x 16A) can be fed in
- Simple installation

Housing	Plastic	Rated Input Voltage	220-240 V/AC
Height	35 mm	Output Current	16 A
Ø	110 mm		

Article	Housing Color	Price
710512	<input type="checkbox"/> White	€ 34.95
710513	<input checked="" type="checkbox"/> Black	€ 34.95





D LINE DALI BUILT-IN POWERTRACK

- Controllable with DALI
- up to 3 phases (3x 16A) can be fed in
- Many different mounting options

Housing	Aluminium	Rated Input Voltage	220-240 V/AC
Width	56 mm	Output Current	16 A
Height	35.5 mm		

Article	Housing Color	Length	Price
710506	<input type="checkbox"/> White	1000 mm	€ 57.95
710507	<input checked="" type="checkbox"/> Black	1000 mm	€ 57.95
710508	<input type="checkbox"/> White	2000 mm	€ 104.95
710509	<input checked="" type="checkbox"/> Black	2000 mm	€ 104.95
710510	<input type="checkbox"/> White	3000 mm	€ 149.95
710511	<input checked="" type="checkbox"/> Black	3000 mm	€ 149.95



D LINE QUICK-MOUNTING BRACKET FOR INSTALLATION RAIL

- Suitable for installation system
- to simplify the installation of recessed conductor rails
- no additional substructures required for fastening

Housing	Steel	Length	70 mm
Mounting Type	Installation mounting	Width	45 mm
		Height	25 mm

Article	Housing Color	Price
710107	<input type="checkbox"/> Silver	€ 4.95

IP20

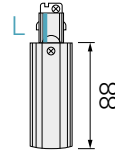

D LINE DALI ELECTRICAL FEEDER LEFT

- can be controlled with DALI, up to three phases can be fed in
- Cable entry through the side or from the ceiling
- easy to install
- suitable for surface-mounted and recessed systems

Housing	Plastic	Height	35.5 mm
Length	139 mm	Rated Input Voltage	220-240 V/AC
Width	35.2 mm	Output Current	16 A

Article	Housing Color	Price
710514	<input type="checkbox"/> White	€ 18.95
710515	<input checked="" type="checkbox"/> Black	€ 18.95



D LINE DALI ELECTRICAL FEEDER RIGHT

- can be controlled with DALI, up to three phases can be fed in
- Cable entry through the side or from the ceiling
- easy to install
- suitable for surface-mounted and recessed systems

Housing	Plastic	Height	35.5 mm
Length	139 mm	Rated Input Voltage	220-240 V/AC
Width	35.2 mm	Output Current	16 A

Article	Housing Color	Price
710516	<input type="checkbox"/> White	€ 18.95
710517	<input checked="" type="checkbox"/> Black	€ 18.95

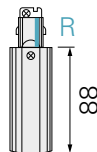

Accessories for **710516**

710518 D Line DALI cover panel feed left/right, white



€ 3.95

Accessories for **710517**

710519 D Line DALI cover panel feed left/right, black



€ 3.95



D LINE DALI STRAIGHT CONNECTOR WITH FEED OPTION

- can be controlled with DALI, up to three phases can be fed in
- Cable entry through the side or from the ceiling
- easy to install
- suitable for surface-mounted and recessed systems

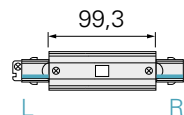

Housing	Plastic	Height	35.5 mm
Length	203 mm	Rated Input Voltage	220-240 V/AC
Width	35.2 mm	Output Current	16 A

Article	Housing Color	Price
710520	<input type="checkbox"/> White	€ 34.95
710521	<input checked="" type="checkbox"/> Black	€ 34.95



Accessories for **710520**

710090 D Line/Dali cover panel for longitudinal connector



€ 3.95

Accessories for **710521**

710522 D Line DALI cover panel for longitudinal connector, black



€ 3.95

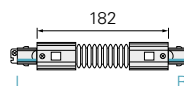

D LINE DALI FLEX CONNECTOR

- controllable with DALI
- Simple installation
- compensates for different height levels / angles in the track system
- suitable for surface-mounted system

Housing	Plastic	Height	35.5 mm
Length	285 mm	Rated Input Voltage	220-240 V/AC
Width	35.2 mm	Output Current	16 A

Article	Housing Color	Price
710523	<input type="checkbox"/> White	€ 46.95
710524	<input checked="" type="checkbox"/> Black	€ 46.95

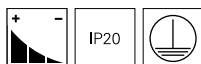



D LINE DALI ELECTRIC CONNECTOR

- easy to install
- suitable for surface-mounted and recessed systems

Housing	Plastic	Height	26.5 mm
Length	107 mm	Rated Input Voltage	220-240 V/AC
Width	20.5 mm	Output Current	16 A

Article	Housing Color	Price
710525	<input type="checkbox"/> White	€ 11.95
710526	<input checked="" type="checkbox"/> Black	€ 11.95



D LINE MECHANICAL CONNECTOR

- Mechanical connector without electrical contacts
- for electrical isolation of 2 different circuits within a track system
- suitable for surface-mounted and built-in systems

Housing	Plastic	Width	20 mm
Mounting Type	Top mounting	Height	27 mm
Length	66.4 mm		

Article	Housing Color	Price
710018	<input type="checkbox"/> White	€ 6.95
710020	<input checked="" type="checkbox"/> Black	€ 6.95



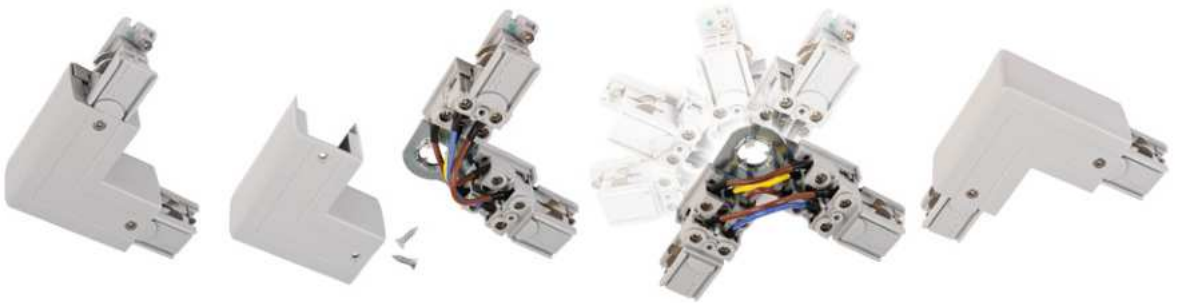

D LINE DALI 90°-CONNECTOR

- with reversal mechanism for switching the orientation between left and right
- easy to install
- suitable for surface-mounted and recessed systems

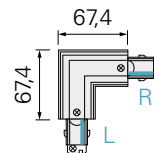

Housing	Plastic	Height	35.5 mm
Length	119 mm	Rated Input Voltage	220-240 V/AC
Width	119 mm	Output Current	16 A

Article	Housing Color	Price
710527	White	€ 38.95
710528	Black	€ 38.95



Accessories for **710527**

710091	D Line/Dali cover panel for 90° connector		€ 3.95
---------------	---	---	--------

Accessories for **710528**

710529	D Line DALI cover panel for 90° connector, black		€ 3.95
---------------	--	---	--------

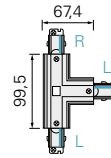

D LINE DALI T-CONNECTOR LEFT-LEFT-RIGHT

- with reversal mechanism for switching the orientation between left and right
- easy to install
- suitable for surface-mounted and recessed systems

Housing	Plastic	Height	35.5 mm
Length	203 mm	Rated Input Voltage	220-240 V/AC
Width	119 mm	Output Current	16 A

Article	Housing Color	Price
710530	<input type="checkbox"/> White	€ 54.95
710531	<input checked="" type="checkbox"/> Black	€ 54.95



D LINE DALI T-CONNECTOR RIGHT-RIGHT-LEFT

- with reversal mechanism for switching the orientation between left and right
- easy to install
- suitable for surface-mounted and recessed systems

Housing	Plastic	Height	35.5 mm
Length	203 mm	Rated Input Voltage	220-240 V/AC
Width	119 mm	Output Current	16 A

Article	Housing Color	Price
710532	<input type="checkbox"/> White	€ 54.95
710533	<input checked="" type="checkbox"/> Black	€ 54.95

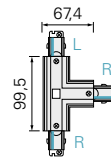

Accessories for **710532**

710093 D Line/Dali cover panel for T-connector



€ 3.95

Accessories for **710533**

710534 D Line DALI cover panel for T-connector, black



€ 3.95



D LINE DALI X-CONNECTOR

- easy to install
- suitable for surface-mounted and recessed systems

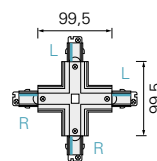

Housing	Plastic	Height	35.5 mm
Length	203 mm	Rated Input Voltage	220-240 V/AC
Width	203 mm	Output Current	16 A

Article	Housing Color	Price
710535	□ White	€ 69.95
710536	■ Black	€ 69.95



Accessories for **710535**

710092 D Line/Dali cover panel for X-connector  **€ 4.95**

Accessories for **710536**

710537 D Line DALI cover panel for X-connector, black  **€ 4.95**



D LINE COVER PANEL

- Suitable for surface-mounted and recessed systems
- for closing publicly accessible conductor rails within a contact zone of less than 2.30 m

Housing	Plastic	Width	21.5 mm
Mounting Type	Top mounting	Height	7.5 mm
Length	1000 mm		

Article	Housing Color	Price
710077	<input type="checkbox"/> White	€ 5.95
710079	<input checked="" type="checkbox"/> Black	€ 5.95



D LINE END CAP

- For closing open busbar ends (contact hazard protection)
- Simple installation
- Suitable for surface-mounted system

Housing	Plastic	Height	32.5 mm
---------	---------	--------	---------

Article	Housing Color	Mounting Type	Length	Width	Price
710066	<input type="checkbox"/> White	Top mounting	31.3 mm	35.2 mm	€ 2.95
710068	<input checked="" type="checkbox"/> Black	Top mounting	31.3 mm	35.2 mm	€ 2.95
710103	<input type="checkbox"/> White	Installation mounting	56 mm	47.9 mm	€ 2.95
710538	<input checked="" type="checkbox"/> Black	Installation mounting	56 mm	47.9 mm	€ 2.95



D LINE MOUNTING BRACKET FLEX

- Suitable for surface-mounted system
- Simplifies the assembly of more complex shapes
- conductor rail remains „movable“ during installation

Housing	Metal	Width	33.8 mm
Mounting Type	Top mounting	Height	12.5 mm
Length	40 mm		

Article	Housing Color	Price
710063	□ White	€ 5.95
710065	■ Black	€ 5.95



D LINE WALL BRACKET

- Suitable for surface-mounted system
- simplifies the installation of track close to the wall
- ideal for illuminating pictures and objects, e.g. in exhibitions, collections, museums, etc.

Housing	Aluminium	Width	25 mm
Mounting Type	Top mounting	Height	80 mm
Length	91.9 mm		

Article	Housing Color	Price
710104	□ White	€ 14.95
710106	■ Black	€ 14.95

IP20



D LINE SUSPENSION CONNECTION BRACKET

- Suitable for surface-mounted system
- for chain mounting or similar (chain not included)

Housing	Metal	Width	32 mm
Mounting Type	Top mounting	Height	20 mm
Length	181 mm		

Article	Housing Color	Price
710057	<input type="checkbox"/> White	€ 9.95
710059	<input checked="" type="checkbox"/> Black	€ 9.95



D LINE CEILING SUSPENSION RIGID

- Stable and elegant suspension
- Suitable for surface-mounted system
- Suspension dimension 635 mm (can be shortened to 335 mm)
- Suspension dimension can be extended using accessories

Housing	Aluminium	Length	635 mm
Mounting Type	Top mounting	Width	60 mm

Article	Housing Color	Price
710078	<input type="checkbox"/> White	€ 32.95
710084	<input checked="" type="checkbox"/> Black	€ 32.95



D LINE EXTENSION FOR CEILING SUSPENSION RIGID

- Suitable for rigid ceiling suspension
- increases the suspension dimension by 300 mm in each case

Housing	Aluminium	Length	310 mm
Mounting Type	Top mounting	Width	10 mm

Article	Housing Color	Price
710086	<input type="checkbox"/> White	€ 5.95
710087	<input checked="" type="checkbox"/> Black	€ 5.95



D LINE ROPE SUSPENSION BRACKET

- Can be cut to length for suspension dimension: 120-1,500 mm
- suitable for surface-mounted systems

Housing	Metal	Width	31 mm
Mounting Type	Top mounting	Height	52 mm
Length	120 mm		

Article	Housing Color	Price
710048	<input type="checkbox"/> White	€ 14.95
710050	<input checked="" type="checkbox"/> Black	€ 14.95

Accessories

710081 D Line/Dali cable for cable suspension 4.0 m



D LINE ROPE SUSPENSION BRACKET MINI

- Elegant and filigree suspension
- Suspension dimensions can be individually shortened: 90-4960 mm
- Suitable for surface-mounted system

Housing	Metal	Width	31 mm
Mounting Type	Top mounting	Height	58 mm
Length	120 mm		

Article	Housing Color	Price
710094	<input type="checkbox"/> White	€ 19.95
710096	<input checked="" type="checkbox"/> Black	€ 19.95



D LINE FAST-MOUNTING BRACKET

- Suitable for surface-mounted system
- conductor rail is fixed without tools using knurled screw and spring clip fixed in place
- Quick installation and removal, e.g. in exhibition stand construction

Housing	Aluminium	Width	30 mm
Mounting Type	Top mounting	Height	11.9 mm
Length	40 mm		

Article	Housing Color	Price
710082	■ Black	€ 10.95



D LINE TRUSS ADAPTER

- Suitable for surface-mounted system
- Quick-release fasteners for fast mounting of conductor rails on truss structures
- Suitable for all 50 mm aluminium trusses in event technology / trade fair construction

Housing	Aluminium	Width	30 mm
Mounting Type	Top mounting	Height	11.9 mm
Length	40 mm		

Article	Housing Color	Price
710083	■ Silver	€ 29.95



This little »jack-of-all-trades« makes mounting a track on an existing grid ceiling child's play. The installation time is only a fraction of what it used to be. In the first step, the clip is simply clicked into the visible metal strips of the grid ceiling and is held bomb-proof on the ceiling by means of a safety spring clip. After that, the conductor rail is simply pushed onto it and the installation is finished.





D LINE GRID CEILING FAST-MOUNTING BRACKET

- Suitable for surface-mounted system
- Quick and easy installation on grid ceilings
- mechanical load up to 15.0 kg / 150N
- suitable for 22-24mm grid ceiling support rails

Housing	Metal	Width	31 mm
Mounting Type	Top mounting	Height	11 mm
Length	120 mm		

Article	Housing Color	Price
710051	<input type="checkbox"/> White	€ 11.95
710053	<input checked="" type="checkbox"/> Black	€ 11.95





D LINE DALI THREE-PHASE ADAPTER FOR INSTALLING LAMPS

- can be controlled with DALI, up to three phases can be fed in
- easy to install
- suitable for surface-mounted and recessed systems

Housing	Plastic	Height	51 mm
Length	113 mm	Rated Input Voltage	220-240 V/AC
Width	32 mm	Output Current	10 A

Article	Housing Color	Price
710539	<input type="checkbox"/> White	€ 23.95
710540	<input checked="" type="checkbox"/> Black	€ 23.95



D LINE SOCKET ADAPTER

- easy to install
- suitable for surface-mounted and recessed systems
- as power distribution system in current tracks
- max. 1,380 W
- integrated plug fuse

Housing	Plastic	Width	53.5 mm
Mounting Type	Top mounting, Installation mounting	Height	103 mm
Length	58.5 mm	Rated Input Voltage	230 V/AC
		Output Current	6 A

Article	Housing Color	Price
710024	<input type="checkbox"/> White	€ 28.95
710026	<input checked="" type="checkbox"/> Black	€ 28.95





D LINE MOUNTING ADAPTER FOR ADDITIONAL COMPONENTS

- Suitable for surface-mounted and recessed systems
- Mounting adapter (M6 thread) as holder for additional devices and lights
- perfect use in conjunction with optional D Line socket outlet adapter
- max. load 10kg / 100N

Housing	Metal, Plastic	Width	31.5 mm
Mounting Type	Top mounting	Height	84 mm
Length	66.5 mm		

Article	Housing Color	Price
710054	<input type="checkbox"/> White	€ 10.95
710056	<input checked="" type="checkbox"/> Black	€ 10.95



D LINE SIGN HOOK

- Suitable for surface-mounted and recessed systems
- Hook for attaching information signs etc.
- Load max. 5kg / 50N

Housing	Plastic	Height	52 mm
Mounting Type	Top mounting	Ø	25 mm

Article	Housing Color	Price
710060	<input type="checkbox"/> White	€ 2.95
710062	<input checked="" type="checkbox"/> Black	€ 2.95

3-phases power luminaires



page 350



page 351



page 351



page 352



page 353



page 353



page 354



page 358



page 359



page 360



page 361



page 362



□ ■
page 363



□ ■ ■
page 364



■ □
page 365



□ ■
page 366



■ □
page 369



□ ■ ■
page 370



□ ■ ■
page 372



□ ■
page 374



□ ■
page 376



□ ■
page 378



□ ■
page 380



□ ■
page 381



■ □
page 382



■ ■
page 383



PANEL TRACK LIGHT

- Ideal for homogeneous basic lighting
- Can be rotated and swivelled
- High luminous flux

Housing	Aluminium	Power Supply Unit incl.	Yes
Length	300 mm	Light Beam Angle	110 Degree
Width	110 mm	Swivelling Angle	90 Degree
Height	8.5 mm	Colour Rendering Index (Ra)	80
Power	20 W		
Rated Input Voltage	110-240 V/AC		

Article	Housing Color	Colour Temperature	Luminous Flux	Price
707134	□ White	WW 3000 K	2000 lm	€ 109.95
707135	■ Black	WW 3000 K	2000 lm	€ 109.95
707136	□ White	NW 4000 K	2200 lm	€ 109.95
707137	■ Black	NW 4000 K	2200 lm	€ 109.95





FLOOD SMD 15 W

- Can be rotated and swivelled
- Large tilt angle

Housing	Aluminium	Rated Input Voltage	220-240 V/AC
Length	192 mm	Power Supply Unit incl.	Yes
Width	180 mm	Light Beam Angle	90 Degree
Height	38 mm	Swivelling Angle	180 Degree
Base Length	179 mm	Colour Rendering Index (Ra)	80
Base Width	20 mm	IK Protection Class	IK07
Power	15 W		

Article	Housing Color	Colour Temperature	Luminous Flux	Price
707130	<input type="checkbox"/> White	3000 K	1575 lm	€ 99.95
707138	<input type="checkbox"/> White	4000 K	1650 lm	€ 99.95

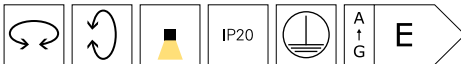

FLOOD SMD 30 W

- Can be rotated and swivelled
- Large tilt angle

Housing	Aluminium	Rated Input Voltage	220-240 V/AC
Length	261 mm	Power Supply Unit incl.	Yes
Width	236 mm	Light Beam Angle	90 Degree
Height	41 mm	Swivelling Angle	180 Degree
Base Length	237 mm	Colour Rendering Index (Ra)	80
Base Width	25 mm	IK Protection Class	IK07
Power	30 W		

Article	Housing Color	Colour Temperature	Luminous Flux	Price
707139	<input type="checkbox"/> White	3000 K	3150 lm	€ 139.95
707140	<input type="checkbox"/> White	4000 K	3300 lm	€ 139.95

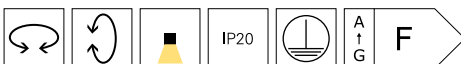



DRACONIS





- Output adjustable in three stages
- Light colour adjustable in three stages
- High luminous flux
- Interchangeable lenses

Housing	Aluminium	Base Height	25 mm
Colour Temperature	2700/3500/4000 K	Power Selectable	45 W, 55 W, 72 W
Luminous Flux	7330/8210/8250 lm	Rated Input Voltage	220-240 V/AC
Length	577.6 mm	Power Supply Unit incl.	Yes
Width	188.6 mm	Light Beam Angle	60 Degree
Height	128.7 mm	Colour Rendering Index (Ra)	80
Base Length	102 mm		
Base Width	88 mm		

Article	Housing Color		Price
620119	<input type="checkbox"/> Aluminum	<input type="checkbox"/> WW <input type="checkbox"/> NW	€ 349.95
620120	<input type="checkbox"/> White	<input type="checkbox"/> WW <input type="checkbox"/> NW	€ 349.95



Accessories

930544	20° Lense for surface-mounted ceiling light Draconis symmetrical		€ 9.95
930545	30° Lense for surface-mounted ceiling light Draconis symmetrical		€ 9.95
930546	90° Lense for surface-mounted ceiling light Draconis symmetrical		€ 9.95
930577	15° Lense for surface-mounted ceiling light Draconis asymmetrical		€ 9.95





LINEAR 60

- low height
- homogeneous illumination

Housing	Aluminium	Rated Input Voltage	200-240 V/AC
Surface	Matt	Power Supply Unit incl.	Yes
Length	687 mm	Light Beam Angle	110 Degree
Width	62 mm	Colour Rendering Index (Ra)	80
Height	32 mm		
Power	18 W		

Article	Housing Color	Colour Temperature	Luminous Flux	Price
707148	■ Black	WW 3000 K	1950 lm	€ 139.95
707147	□ White	WW 3000 K	2100 lm	€ 139.95
707150	■ Black	NW 4000 K	2100 lm	€ 139.95
707149	□ White	NW 4000 K	2300 lm	€ 139.95

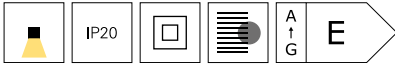

LINEAR 100

- low height
- homogeneous illumination

Housing	Aluminium	Rated Input Voltage	200-240 V/AC
Surface	Matt	Power Supply Unit incl.	Yes
Length	1087 mm	Light Beam Angle	110 Degree
Width	62 mm	Colour Rendering Index (Ra)	80
Height	32 mm		
Power	28 W		

Article	Housing Color	Colour Temperature	Luminous Flux	Price
707152	■ Black	WW 3000 K	3100 lm	€ 179.95
707151	□ White	WW 3000 K	3200 lm	€ 179.95
707154	■ Black	NW 4000 K	3200 lm	€ 179.95
707153	□ White	NW 4000 K	3400 lm	€ 179.95

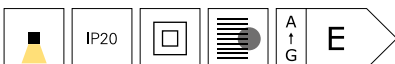



ALNITAK

- Power adjustable in four stages
- can be rotated and swivelled
- low glare value
- for D LINE, Ivela and Hoffmeister three-phase current tracks

Housing	Aluminium	Rated Input Voltage	220-240 V/AC
Length	336 mm	Power Supply Unit incl.	Yes
Width	36 mm	Light Beam Angle	34 Degree
Height	49 mm	Swivelling Angle	25 Degree
Power Selectable	25.2 W, 29.4 W, 31.5 W, 33.6 W	Colour Rendering Index (Ra)	80

Article	Housing Color	Colour Temperature	Luminous Flux	Price
707110	<input type="checkbox"/> White	3000 K	3114 lm	€ 169.95
707112	<input type="checkbox"/> Silver	3000 K	3114 lm	€ 169.95
707114	<input type="checkbox"/> Black	3000 K	3114 lm	€ 169.95
707111	<input type="checkbox"/> White	4000 K	3068 lm	€ 169.95
707113	<input type="checkbox"/> Silver	4000 K	3068 lm	€ 169.95
707115	<input type="checkbox"/> Black	4000 K	3068 lm	€ 169.95

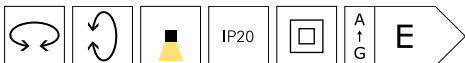

Accessories

930386	Reflector for Ain, Alnitak 12°		€ 1.95
930387	Reflector for Ain, Alnitak 48°		€ 1.95
930388	Ceti Spot anti glare white		€ 2.95





LINEAR PRO

The LINEAR PRO 3-circuit track luminaires are the ideal solution for illuminating shelves and aisles in supermarkets, stores and more. Available in the LINEAR PRO FOLD and LINEAR PRO TILT versions, the LINEAR PRO models enable precise illumination of products and other objects – also in combination with other track spotlights.

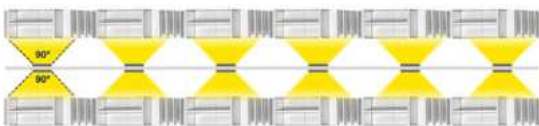





LINEAR PRO FOLD

- Eligible for German BEG federal funding
- can run on emergency power [198-264V/DC EOFI: 100%]
- long service life of 60,000 hours (L80B50)
- particularly energy efficient
- Output adjustable in three steps

Housing	Aluminium	Light Beam Angle	30 Degree
Width	120 mm	Light Beam Angle 2	90 Degree
Height	68 mm	Colour Rendering Index (Ra)	90
Rated Input Voltage	220-240 V/AC	IK Protection Class	IK03
Power Supply Unit incl.	Yes		

Article	Housing Color	Colour Temperature	Luminous Flux	Length	Power Selectable	Price
707205	<input type="checkbox"/> White	3000 K	2900 lm	600 mm	14.0 W / 16.0 W / 18.0 W / 20.0 W	€ 169.95
707206	<input checked="" type="checkbox"/> Black	3000 K	2900 lm	600 mm	14.0 W / 16.0 W / 18.0 W / 20.0 W	€ 169.95
707207	<input type="checkbox"/> White	3000 K	7250 lm	1493 mm	35.0 W / 40.0 W / 45.0 W / 50.0 W	€ 204.95
707208	<input checked="" type="checkbox"/> Black	3000 K	7250 lm	1493 mm	35.0 W / 40.0 W / 45.0 W / 50.0 W	€ 204.95
707189	<input type="checkbox"/> White	4000 K	2900 lm	600 mm	14.0 W / 16.0 W / 18.0 W / 20.0 W	€ 169.95
707190	<input checked="" type="checkbox"/> Black	4000 K	2900 lm	600 mm	14.0 W / 16.0 W / 18.0 W / 20.0 W	€ 169.95
707191	<input type="checkbox"/> White	4000 K	7250 lm	1493 mm	35.0 W / 40.0 W / 45.0 W / 50.0 W	€ 204.95
707192	<input checked="" type="checkbox"/> Black	4000 K	7250 lm	1493 mm	35.0 W / 40.0 W / 45.0 W / 50.0 W	€ 204.95





LINEAR PRO FOLD DALI

- Eligible for German BEG federal funding
- can run on emergency power [198-264V/DC EOFI: 15%]
- long service life of 60,000 hours (L80B50)
- particularly energy efficient

Housing	Aluminium	Light Beam Angle	30 Degree
Length	1493 mm	Light Beam Angle 2	90 Degree
Width	120 mm	Control	DALI 2 / DT6
Height	68 mm	Colour Rendering Index (Ra)	90
Power	50 W	IK Protection Class	IK03
Rated Input Voltage	220-240 V/AC		
Power Supply Unit incl.	Yes		

Article	Housing Color	Colour Temperature	Luminous Flux	Price
707210	■ Black	ww 3000 K	7000 lm	€ 234.95
707209	□ White	ww 3000 K	7250 lm	€ 234.95
707194	■ Black	nw 4000 K	7000 lm	€ 234.95
707193	□ White	nw 4000 K	7250 lm	€ 234.95





LINEAR PRO TILT

- Eligible for German BEG federal funding
- can run on emergency power [198-264 V/DC EOFI: 100%]
- can be locked shining downwards
- can be swivelled up to 30° to each side
- long service life of 60,000 hours (L80B50)
- particularly energy efficient
- Output adjustable in three steps

Housing	Steel	Light Beam Angle	60 Degree
Width	60 mm	Swivelling Angle	60 Degree
Height	54 mm	Colour Rendering Index (Ra)	90
Rated Input Voltage	220-240 V/AC	IK Protection Class	IK03
Power Supply Unit incl.	Yes		

Article	Housing Color	Colour Temperature	Luminous Flux	Length	Power Selectable	Price
707195	<input type="checkbox"/> White	3000 K	3200 lm	600 mm	14.0 W / 16.0 W / 18.0 W / 20.0 W	€ 149.95
707196	<input checked="" type="checkbox"/> Black	3000 K	3200 lm	600 mm	14.0 W / 16.0 W / 18.0 W / 20.0 W	€ 149.95
707197	<input type="checkbox"/> White	3000 K	8000 lm	1493 mm	35.0 W / 40.0 W / 45.0 W / 50.0 W	€ 184.95
707198	<input checked="" type="checkbox"/> Black	3000 K	8000 lm	1493 mm	35.0 W / 40.0 W / 45.0 W / 50.0 W	€ 184.95
707141	<input type="checkbox"/> White	4000 K	3200 lm	600 mm	14.0 W / 16.0 W / 18.0 W / 20.0 W	€ 149.95
707142	<input checked="" type="checkbox"/> Black	4000 K	3200 lm	600 mm	14.0 W / 16.0 W / 18.0 W / 20.0 W	€ 149.95
707143	<input type="checkbox"/> White	4000 K	8000 lm	1493 mm	35.0 W / 40.0 W / 45.0 W / 50.0 W	€ 184.95
707144	<input checked="" type="checkbox"/> Black	4000 K	8000 lm	1493 mm	35.0 W / 40.0 W / 45.0 W / 50.0 W	€ 184.95





LINEAR PRO TILT DALI

- Eligible for German BEG federal funding
- can run on emergency power [198-264V/DC EOFI: 15%]
- can be locked shining downwards
- can be swivelled up to 30° to each side
- long service life of 60,000 hours (L80B50)
- particularly energy efficient

Housing	Steel	Power Supply Unit incl.	Yes
Luminous Flux	8000 lm	Light Beam Angle	60 Degree
Length	1493 mm	Swivelling Angle	60 Degree
Width	60 mm	Control	DALI 2 / DT6
Height	54 mm	Colour Rendering Index (Ra)	90
Power	50 W	IK Protection Class	IK03
Rated Input Voltage	220-240 V/AC		

Article	Housing Color	Colour Temperature	Price
707199	<input type="checkbox"/> White	3000 K	€ 214.95
707200	<input checked="" type="checkbox"/> Black	3000 K	€ 214.95
707145	<input type="checkbox"/> White	4000 K	€ 214.95
707146	<input checked="" type="checkbox"/> Black	4000 K	€ 214.95





LINEAR PRO DALI

- Eligible for German BEG federal funding
- can run on emergency power [198-264V/DC EOFFI: 15%]
- long service life of 60,000 hours (L80B50)
- particularly energy efficient

Housing	Aluminium	Power Supply Unit incl.	Yes
Length	602 mm	Light Beam Angle	120 Degree
Width	61.1 mm	Control	DALI 2 / DT6
Height	58 mm	Colour Rendering Index (Ra)	90
Power Selectable	14 W, 16 W, 18 W, 20 W	IK Protection Class	IK03
Rated Input Voltage	220-240 V/AC		

Article	Housing Color	Colour Temperature	Luminous Flux	Price
707220	■ Black	ww 3000 K	2800 lm	€ 139.95
707219	□ White	ww 3000 K	2850 lm	€ 139.95
707222	■ Black	nw 4000 K	2850 lm	€ 139.95
707221	□ White	nw 4000 K	2900 lm	€ 139.95





LINEAR PRO DALI CCT

- Eligible for German BEG federal funding
- can run on emergency power [198-264V/DC EOfI: 15%]
- long service life of 60,000 hours (L80B50)
- particularly energy efficient

Housing	Aluminium	Rated Input Voltage	220-240 V/AC
Colour Temperature	3000/3500/4000 K	Power Supply Unit incl.	Yes
Length	1196 mm	Light Beam Angle	120 Degree
Width	61.1 mm	Control	DALI 2 / DT6
Height	58 mm	Colour Rendering Index (Ra)	90
Power Selectable	28 W, 32 W, 36 W, 40 W	IK Protection Class	IK03

Article	Housing Color		Luminous Flux	Price
707224	Black	WW NW	4800/5000/4900 lm	€ 179.95
707223	White	WW NW	4900/5100/5000 lm	€ 179.95





CAN

- customised lighting solution thanks to replaceable light source
- can be combined with the product family of the CAN series

Housing	Aluminium	Rated Input Voltage	220-240 V/AC
Length	134 mm	Control	Dimmable via optional light source
Ø	60 mm	Swivelling Angle	90 Degree
Sockets	1		
Max. Power	1x max. 7.5 W		

Article	Housing Color	Price
707079	□ White	€ 49.95
707080	■ Silver	€ 49.95
707081	■ Black	€ 49.95

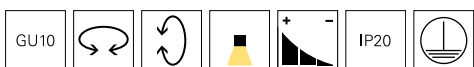

Accessories

930301	Reflector ring white for series Klara / Nihal Mini / Rigel Mini / Can		€ 4.95
930302	Reflector ring black for series Klara / Nihal Mini / Rigel Mini / Can		€ 4.95
930303	Reflector ring gold for series Klara / Nihal Mini / Rigel Mini / Can		€ 4.95
930366	Reflector ring silver for series Klara / Nihal Mini / Rigel Mini / Can		€ 4.95



page 51

page 88

page 90

page 91

page 181

page 194

page 195



HORUS

- low glare value
- can be rotated and swivelled

Housing	Plastic	Light Beam Angle	40 Degree
Surface	Matt	Swivelling Angle	350 Degree
Rated Input Voltage	220-240 V/AC	Colour Rendering Index (Ra)	80
Power Supply Unit incl.	Yes		

Article	Housing Color	Colour Temperature	Luminous Flux	Height	Ø	Power	EEL	Price
707094	Black	3000 K	625 lm	125 mm	60 mm	7.0 W	E	€ 69.95
707095	White	3000 K	625 lm	125 mm	60 mm	7.0 W	E	€ 69.95
707098	Black	3000 K	915 lm	140 mm	70 mm	10.0 W	E	€ 79.95
707099	White	3000 K	915 lm	140 mm	70 mm	10.0 W	E	€ 79.95
707102	Black	3000 K	1705 lm	185 mm	80 mm	20.0 W	F	€ 89.95
707103	White	3000 K	1705 lm	185 mm	80 mm	20.0 W	F	€ 89.95
707106	Black	3000 K	2525 lm	210 mm	90 mm	30.0 W	F	€ 109.95
707107	White	3000 K	2525 lm	210 mm	90 mm	30.0 W	F	€ 109.95
707096	Black	4000 K	635 lm	125 mm	60 mm	7.0 W	E	€ 69.95
707097	White	4000 K	635 lm	125 mm	60 mm	7.0 W	E	€ 69.95
707100	Black	4000 K	1030 lm	140 mm	70 mm	10.0 W	E	€ 79.95
707101	White	4000 K	1030 lm	140 mm	70 mm	10.0 W	E	€ 79.95
707104	Black	4000 K	1785 lm	185 mm	80 mm	20.0 W	F	€ 89.95
707105	White	4000 K	1785 lm	185 mm	80 mm	20.0 W	F	€ 89.95
707108	Black	4000 K	2605 lm	210 mm	90 mm	30.0 W	F	€ 109.95
707109	White	4000 K	2605 lm	210 mm	90 mm	30.0 W	F	€ 109.95

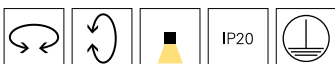

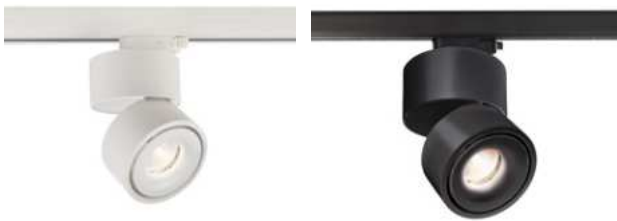

UNI II











- Very high colour rendering
- can be rotated and swivelled
- dimmable

Housing	Aluminium	Power Supply Unit incl.	Yes
Colour Temperature	3000 K	Light Beam Angle	36 Degree
Luminous Flux	910 lm	Swivelling Angle	90 Degree
Height	167 mm	Control	Leading-edge dimmer, Trailing-edge dimmer
Ø	100 mm	Colour Rendering Index (Ra)	90
Power	17 W		
Rated Input Voltage	220-240 V/AC		

Article	Housing Color		Price
707044	White		€ 179.95
707131	Black		€ 179.95



Accessories

930339	Reflector ring black for series Uni II		€ 10.95
930340	Reflector ring gold for series Uni II		€ 10.95
930341	Reflector ring chrome for series Uni II		€ 10.95
930335	Cover back black for series Uni II		€ 2.95
930337	Cover heatsink black for series Uni II		€ 7.95
930306	Reflector 48° for series Klara / Nihal Mini / Rigel Mini / Uni II		€ 8.95
930307	Honeycomb filter for series Klara / Nihal Mini / Rigel Mini / Uni II		€ 8.95
930308	Spread lense for series Klara / Nihal Mini / Rigel Mini / Uni II		€ 8.95
930309	Softening lense for series Klara / Nihal Mini / Rigel Mini / Uni II		€ 8.95
930310	Linear spread lense for series Klara / Nihal Mini / Rigel Mini / Uni II		€ 8.95



page 70



page 72



page 74



page 78



page 140



page 143



page 172



Lighting design

Interested in our lighting design service?

Your contact person will be happy to answer any questions you may have.





AARON

- can be rotated and swivelled
- high luminous flux

Housing	Aluminium	Power	79 W
Surface	Matt	Rated Input Voltage	220-240 V/AC
Luminous Flux	7400 lm	Power Supply Unit incl.	Yes
Length	120 mm	Light Beam Angle	40 Degree
Width	182 mm	Swivelling Angle	90 Degree
Height	255 mm	Colour Rendering Index (Ra)	90
Ø	120 mm		

Article	Housing Color	Colour Temperature	EEL	Price
707090	Black	3000 K	E	€ 499.95
707092	White	3000 K	E	€ 499.95
707091	Black	4000 K	F	€ 499.95
707093	White	4000 K	F	€ 499.95



Technical data sheet

New in the onlineshop: The technical data sheets offer even more information: Light and energy data, light distribution curves, dimensional drawings and more.



NIHAL







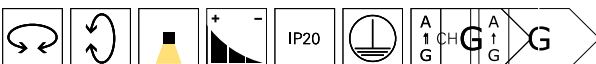



- can be rotated and swivelled
- large tilt angle

Housing	Aluminium	Light Beam Angle	33 Degree
Length	135 mm	Swivelling Angle	180 Degree
Width	138 mm	Control	Leading-edge dimmer, Trailing-edge dimmer
Height	188 mm		
Ø	86 mm	Colour Rendering Index (Ra)	90
Rated Input Voltage	220-240 V/AC		
Power Supply Unit incl.	Yes		

Article	Housing Color	Colour Temperature	Luminous Flux	Power	Price
707040	<input type="checkbox"/> White	3000 K	2450 lm	33.0 W	€ 219.95
707041	<input checked="" type="checkbox"/> Black	3000 K	2450 lm	33.0 W	€ 219.95
707056	<input type="checkbox"/> Silver	3000 K	2470 lm	33.0 W	€ 219.95
707043	<input checked="" type="checkbox"/> Black	4000 K	2860 lm	33.0 W	€ 219.95
707042	<input type="checkbox"/> White	4000 K	2860 lm	34.0 W	€ 219.95
707057	<input type="checkbox"/> Silver	4000 K	2860 lm	35.0 W	€ 219.95



Accessories

930315	Reflector ring white for series Nihal		€ 4.95
930316	Reflector ring black for series Nihal		€ 4.95
930365	Reflector ring silver for series Nihal		€ 4.95
930317	Reflector ring Gold for series Nihal		€ 4.95
930311	Side cover white for series Nihal		€ 5.95
930312	Side cover black for series Nihal		€ 5.95
930363	Side cover silver for series Nihal		€ 5.55
930313	Side cover gold for series Nihal		€ 5.95
930314	Side cover walnut wood look for series Nihal		€ 7.95
930769	Side cover natural oak wood look series Nihal		€ 7.95

Accessories

930318	Reflector 15° for series Nihal		€ 17.95
930320	Reflector 50° for series Nihal		€ 17.95
930321	Honeycomb filter for series Nihal		€ 10.95
930322	Spread lense for series Nihal 37°		€ 10.95
930323	Softening lense for series Nihal 37°		€ 10.95
930324	Linear spread lense for series Nihal 40° / 80°		€ 10.95





NIHAL MINI







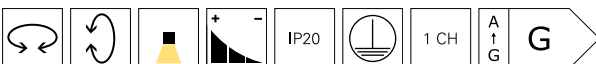

- Can be rotated and swivelled
- Large tilt angle

Housing	Aluminium	Power Supply Unit incl.	Yes
Length	94 mm	Light Beam Angle	35 Degree
Width	102 mm	Swivelling Angle	180 Degree
Height	139 mm	Control	Leading-edge dimmer, Trailing-edge dimmer
Ø	60 mm	Colour Rendering Index (Ra)	90
Power	15 W		
Rated Input Voltage	220-240 V/AC		

Article	Housing Color	Colour Temperature	Luminous Flux	Price
707036	<input type="checkbox"/> White	3000 K	950 lm	€ 169.95
707037	<input checked="" type="checkbox"/> Black	3000 K	950 lm	€ 169.95
707054	<input type="checkbox"/> Silver	3000 K	950 lm	€ 169.95
707038	<input type="checkbox"/> White	4000 K	1180 lm	€ 169.95
707039	<input checked="" type="checkbox"/> Black	4000 K	1180 lm	€ 169.95
707055	<input type="checkbox"/> Silver	4000 K	1180 lm	€ 169.95



Accessories

930301	Reflector ring white for series Klara / Nihal Mini / Rigel Mini / Can		€ 4.95
930302	Reflector ring black for series Klara / Nihal Mini / Rigel Mini / Can		€ 4.95
930303	Reflector ring gold for series Klara / Nihal Mini / Rigel Mini / Can		€ 4.95
930297	Side cover white for series Nihal Mini		€ 3.95
930298	Side cover black for series Nihal Mini		€ 3.95
930364	Side cover silver for series Nihal Mini		€ 3.95
930299	Side cover gold for series Nihal Mini		€ 3.95
930300	Side cover wood look walnut series Nihal Mini		€ 5.95
930768	Side cover natural oak wood look series Nihal Mini		€ 5.95

Accessories

930306	Reflector 48° for series Klara / Nihal Mini / Rigel Mini / Uni II		€ 8.95
930307	Honeycomb filter for series Klara / Nihal Mini / Rigel Mini / Uni II		€ 8.95
930308	Spread lense for series Klara / Nihal Mini / Rigel Mini / Uni II		€ 8.95
930309	Softening lense for series Klara / Nihal Mini / Rigel Mini / Uni II		€ 8.95
930310	Linear spread lense for series Klara / Nihal Mini / Rigel Mini / Uni II		€ 8.95
930366	Reflector ring silver for series Klara / Nihal Mini / Rigel Mini / Can		€ 4.95
930767	Lense 12° for series Nihal Mini		€ 10.95





LUCEA CCT

- Particularly soft textile cable
- Light colour adjustable in two stages
- incl. black reflector ring

Housing	Aluminium	Light Beam Angle	36 Degree
Colour Temperature	3000/4000 K	Control	Leading-edge dimmer, Trailing-edge dimmer
Rated Input Voltage	220-240 V/AC	Colour Rendering Index (Ra)	90
Power Supply Unit incl.	Yes		
Pendulum Length	1800 mm		

Article	Housing Color		Luminous Flux	Height	Ø	Power	Price
707124	<input type="checkbox"/> White		1000 lm	157 mm	65 mm	10.0 W	€ 149.95
707125	<input checked="" type="checkbox"/> Black		1000 lm	157 mm	65 mm	10.0 W	€ 149.95
707126	<input type="checkbox"/> White		1500 lm	178 mm	85 mm	15.0 W	€ 169.95
707127	<input checked="" type="checkbox"/> Black		1500 lm	178 mm	85 mm	15.0 W	€ 169.95
707128	<input type="checkbox"/> White		2000 lm	178 mm	85 mm	20.0 W	€ 189.95
707129	<input checked="" type="checkbox"/> Black		2000 lm	178 mm	85 mm	20.0 W	€ 189.95

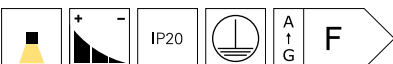

Accessories for **707124, 707125**

930679	Lense 24° for Lucea 6/10 W		€ 9.95
930752	Blind cover for Lucea 6/10 white		€ 22.95
930753	Blind cover for Lucea 6/10 black		€ 22.95
930756	Reflector ring for Lucea 6/10 white		€ 4.95
930757	Reflector ring for Lucea 6/10 black		€ 4.95
930758	Reflector ring for Lucea 6/10 Gold		€ 4.95

Accessories for **707126, 707127, 707128, 707129**

930680	Lense 24° for Lucea 15/20		€ 12.95
930681	Lense 60° for Lucea 15/20		€ 12.95
930754	Blind cover for Lucea 15/20 white		€ 23.95
930755	Blind cover for Lucea 15/20 black		€ 23.95
930759	Reflector ring for Lucea 15/20 white		€ 5.95
930760	Reflector ring for Lucea 15/20 black		€ 5.95
930761	Reflector ring for Lucea 15/20 Gold		€ 5.95



page 46



page 80



page 82



page 287



page 378



Technical data sheet

New in the onlineshop: The technical data sheets offer even more information: Light and energy data, light distribution curves, dimensional drawings and more.



LUCEA DTW

- high colour rendering
- Dim-to-warm 1,800K-2,700K
- incl. black reflector ring

Housing	Aluminium	Power Supply Unit incl.	Yes
Colour Temperature	1800-2700 K	Pendulum Length	1800 mm
Luminous Flux	750 lm	Light Beam Angle	36 Degree
Height	157 mm	Control	Leading-edge dimmer, Trailing-edge dimmer
Ø	65 mm	Colour Rendering Index (Ra)	90
Power	10 W		
Rated Input Voltage	200-240 V/AC		

Article	Housing Color		Price
707217	<input type="checkbox"/> White		€ 129.95
707218	<input checked="" type="checkbox"/> Black		€ 129.95



Accessories

930752	Blind cover for Lucea 6/10 white		€ 22.95
930753	Blind cover for Lucea 6/10 black		€ 22.95
930756	Reflector ring for Lucea 6/10 white		€ 4.95
930757	Reflector ring for Lucea 6/10 black		€ 4.95
930758	Reflector ring for Lucea 6/10 Gold		€ 4.95





LUCEA CCT

- incl. black reflector ring
- Can be customised with a wide range of accessories
- Light colour adjustable in two stages

Housing	Aluminium	Swivelling Angle	90 Degree
Colour Temperature	3000/4000 K	Control	Leading-edge dimmer, Trailing-edge dimmer
Rated Input Voltage	220-240 V/AC	Colour Rendering Index (Ra)	90
Power Supply Unit incl.	Yes		
Light Beam Angle	36 Degree		
Rotation Angle	350 Degree		

Article	Housing Color		Luminous Flux	Height	Ø	Power	Price
707116	<input type="checkbox"/> White		1000 lm	249 mm	65 mm	10.0 W	€ 139.95
707117	<input checked="" type="checkbox"/> Black		1000 lm	249 mm	65 mm	10.0 W	€ 139.95
707118	<input type="checkbox"/> White		1500 lm	269 mm	85 mm	15.0 W	€ 159.95
707119	<input checked="" type="checkbox"/> Black		1500 lm	269 mm	85 mm	15.0 W	€ 159.95
707120	<input type="checkbox"/> White		2000 lm	269 mm	85 mm	20.0 W	€ 179.95
707121	<input checked="" type="checkbox"/> Black		2000 lm	269 mm	85 mm	20.0 W	€ 179.95
707122	<input type="checkbox"/> White		2900 lm	302 mm	100 mm	30.0 W	€ 199.95
707123	<input checked="" type="checkbox"/> Black		2900 lm	302 mm	100 mm	30.0 W	€ 199.95









Accessories for **707116, 707117**

930679	Lense 24° for Lucea 6/10 W		€ 9.95
930752	Blind cover for Lucea 6/10 white		€ 22.95
930753	Blind cover for Lucea 6/10 black		€ 22.95
930756	Reflector ring for Lucea 6/10 white		€ 4.95
930757	Reflector ring for Lucea 6/10 black		€ 4.95
930758	Reflector ring for Lucea 6/10 Gold		€ 4.95

Accessories for **707118, 707119, 707120, 707121**

930680	Lense 24° for Lucea 15/20		€ 12.95
930681	Lense 60° for Lucea 15/20		€ 12.95
930754	Blind cover for Lucea 15/20 white		€ 23.95
930755	Blind cover for Lucea 15/20 black		€ 23.95
930759	Reflector ring for Lucea 15/20 white		€ 5.95
930760	Reflector ring for Lucea 15/20 black		€ 5.95
930761	Reflector ring for Lucea 15/20 Gold		€ 5.95

Accessories for **707122, 707123**

930677	Blind cover for Lucea 30/40 white		€ 24.95
930678	Blind cover for Lucea 30/40 black		€ 24.95
930682	Lense 24° for Lucea 30		€ 15.95
930684	Lense 60° for Lucea 30		€ 15.95
930762	Reflector ring for Lucea 30/40 white		€ 6.95
930763	Reflector ring for Lucea 30/40 black		€ 6.95
930764	Reflector ring for Lucea 30/40 Gold		€ 6.95



page 46



page 80



page 82



page 286



page 374



LUCEA

- incl. black reflector ring
- Can be customised with a wide range of accessories

Housing	Aluminium	Light Beam Angle	36 Degree
Colour Temperature	4000 K	Rotation Angle	350 Degree
Luminous Flux	4480 lm	Swivelling Angle	90 Degree
Height	211 mm	Control	Leading-edge dimmer, Trailing-edge dimmer
Ø	100 mm	Colour Rendering Index (Ra)	90
Power	40 W		
Rated Input Voltage	200-240 V/AC		
Power Supply Unit incl.	Yes		

Article	Housing Color		Price
707183	<input type="checkbox"/> White	NW	€ 199.95
707184	<input checked="" type="checkbox"/> Black	NW	€ 199.95



Accessories

930682	Lense 24° for Lucea 30		€ 15.95
930684	Lense 60° for Lucea 30		€ 15.95
930677	Blind cover for Lucea 30/40 white		€ 24.95
930678	Blind cover for Lucea 30/40 black		€ 24.95
930762	Reflector ring for Lucea 30/40 white		€ 6.95
930763	Reflector ring for Lucea 30/40 black		€ 6.95
930764	Reflector ring for Lucea 30/40 Gold		€ 6.95



LUCEA DTW

- Dim-to-warm 1,800K - 2,700K
- incl. black reflector ring
- Can be customised with a wide range of accessories

Housing	Aluminium	Power Supply Unit incl.	Yes
Colour Temperature	1800-2700 K	Light Beam Angle	36 Degree
Luminous Flux	750 lm	Control	Leading-edge dimmer, Trailing-edge dimmer
Height	249 mm	Colour Rendering Index (Ra)	90
Ø	65 mm		
Power	10 W		
Rated Input Voltage	200-240 V/AC		

Article	Housing Color		Price
707213	<input type="checkbox"/> White	ww	€ 109.95
707214	<input checked="" type="checkbox"/> Black	ww	€ 109.95



Accessories

930752	Blind cover for Lucea 6/10 white		€ 22.95
930753	Blind cover for Lucea 6/10 black		€ 22.95
930756	Reflector ring for Lucea 6/10 white		€ 4.95
930757	Reflector ring for Lucea 6/10 black		€ 4.95
930758	Reflector ring for Lucea 6/10 Gold		€ 4.95





SLIM

- Extra-soft fabric cable
- Glare-free thanks to low UGR value (<19)
- Suspended mounting up to 1800 mm
- Slim design with only 39 mm diameter

Housing	Aluminium
Colour Temperature	2700 K
Luminous Flux	500 lm
Length	1800 mm
Height	300 mm
Ø	39 mm
Power	5 W
Rated Input Voltage	220-240 V/AC

Power Supply Unit incl.	Yes
Pendulum Length	1500 mm
Light Beam Angle	24 Degree
Control	Leading-edge dimmer, Trailing-edge dimmer
Colour Rendering Index (Ra)	90

Article	Housing Color		Price
707161	Black	ww	€ 89.95
707162	White	ww	€ 89.95



Accessories

930748	Lense 36° for series Slim		€ 4.95
930749	Lense 60° for series Slim		€ 4.95
930744	Reflector-ring white for series Slim		€ 4.95
930745	Reflector-ring black for series Slim		€ 4.95
930746	Reflector-ring gold for series Slim		€ 5.95





STUDIO PAR 30

- replaceable lamp (E27)
- can be rotated and swivelled
- integrated mesh chip guard
- incl. adapter

Housing	Aluminium	Max. Power	1x max. 42 W
Length	158.8 mm	Rated Input Voltage	220-240 V/AC
Width	158.8 mm	Control	Dimmable via optional light source
Height	270.8 mm		
Sockets	1		

Article	Housing Color	Price
707082	■ Black	€ 69.95
707083	■ Silver	€ 69.95



Accessories

- 001623** Blind cover
- 001621** Blind cover



€ 29.95

€ 29.95



BATTERY AND SOLAR LIGHTS

386 battery lights

396 solar lights



battery and solar lights



page 388

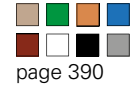

page 390



page 394



page 394

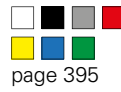

page 395



page 395



page 396



page 396



page 398



page 398





CANIS BUNDLE

Discover our portable cordless LED lamps from the CANIS series. With a 3.5 W output and 270 lm brightness, our lamps provide a particularly wide and pleasant light distribution. And the infinitely variable dimming function allows you to set the perfect illumination using the practical touch sensor. Choose from two light colour levels to create the perfect atmosphere. And the best part? One battery charge is enough for more than eight hours of lighting. You can charge up to six lamps at the same time with the optional charging dock, so you always have enough lights to hand. Choose from eight colours, including trendy pastel tones, to reflect your personal style.

Note: Includes USB charging base





CANIS BUNDLE

- Pleasant and wide light distribution
- More than eight hours of light after charging
- Infinitely dimmable via touch sensor
- Light colour adjustable in two stages
- Charge up to six cordless lamps at the same time using the stackable charging dock (optional)
- Includes USB charging base

Housing	Aluminium	Power	3.5 W
Surface	Matt	Rated Input Voltage	3.7 V/DC
Colour Temperature	2200/3000 K	Light Beam Angle	100 Degree
Luminous Flux	270 lm	Colour Rendering Index (Ra)	80
Height	370 mm		
Ø	112 mm		

Article	Housing Color	Price
620194	Beige	€ 109.95
620195	Green	€ 109.95
620196	Terracotta	€ 109.95
620197	Blue	€ 109.95
620198	Rust	€ 109.95
620199	White	€ 109.95
620200	Black	€ 109.95
620201	Grey	€ 109.95



Accessories

930716 6-times charging station, power supply incl. for Canis



€ 199.95

930887 USB A plug-in power supply 5 V DC, 1,000 mA, black



€ 8.95



CANIS MINI BUNDLE

Discover our portable cordless LED lamps from the CANIS series. With a 2.3W output and 110 lm brightness, our lamps provide a particularly wide and pleasant light distribution. And the infinitely variable dimming function allows you to set the perfect illumination using the practical touch sensor. Choose from two light colour levels to create the perfect atmosphere. And the best part? One battery charge is enough for more than eight hours of lighting. You can charge up to 15 lamps at the same time with the optional charging station, so you always have enough lights to hand. Choose from eight colours, including trendy pastel tones, to reflect your personal style.

Note: Includes USB charging base





CANIS MINI BUNDLE

- Pleasant and wide light distribution
- More than eight hours of light after charging
- Infinitely dimmable using touch sensor
- Light colour adjustable in two stages
- Charge up to 15 cordless lamps at the same time using the stackable charging dock (optional)
- Includes USB charging base

Housing	Aluminium	Ø	76 mm
Surface	Matt	Power	2.3 W
Colour Temperature	2200/3000 K	Rated Input Voltage	3.7 V/DC
Luminous Flux	110 lm	Colour Rendering Index (Ra)	80
Height	208 mm		

Article	Housing Color		Price
620202	Beige		€ 99.95
620203	Green		€ 99.95
620204	Terracotta		€ 99.95
620205	Blue		€ 99.95
620206	Rust		€ 99.95
620207	White		€ 99.95
620208	Black		€ 99.95
620209	Grey		€ 99.95



Accessories

930734 15-times charging station power supply incl. for Canis Mini



€ 299.95

930887 USB A plug-in power supply 5 V DC, 1,000 mA, black



€ 8.95

MIRAM

Combine & shine – with the MIRAM series, there are no more limits to your creativity. Simply combine the luminaire head in your favourite colour with a stand, a wall bracket or a pendant fixture of your choice. In this way, you can create your very own individual luminaire in the twinkling of an eye and recombine it at any time without tools. Flexible, simple, chic - that is MIRAM combine & shine.

it's that simple:

- choose a luminaire head in your favourite colour
- select the desired fastening in your favourite colour

your advantages::

- USB-C cable included
- 147 possible combinations



346025



346033



346032



346034



346035



346036



346037



930625



930627

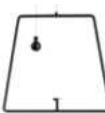

930626



930628



930629



930630



930631



930618



930620



930619



930621



930622



930623



930624



930611



930613



930612



930614



930615



930616



930617





MIRAM

Housing	Aluminium	Rated Input Voltage	3.7 V/DC
Colour Temperature	3000 K	Power Supply Unit incl.	No
Luminous Flux	196 lm	Light Beam Angle	47 Degree
Height	30 mm	Colour Rendering Index (Ra)	80
Ø	120 mm		
Power	2.2 W		

Article	Housing Color	Price
346025	White	€ 99.95
346032	Black	€ 99.95
346033	Grey	€ 99.95
346034	Red	€ 99.95
346035	Yellow	€ 99.95
346036	Blue	€ 99.95
346037	Green	€ 99.95



STAND FOR MAGNETIC LIGHT MIRAM

Housing	Aluminium	Ø	102 mm
Height	270 mm		

Article	Housing Color	Price
930611	White	€ 34.95
930612	Black	€ 34.95
930613	Grey	€ 34.95
930614	Red	€ 34.95
930615	Yellow	€ 34.95
930616	Blue	€ 34.95
930617	Green	€ 34.95



WALL BRACKET, MIRAM SERIES

Housing	Aluminium	Height	96 mm
Width	85 mm	Base Ø	60 mm

Article	Housing Color	Price
930618	White	€ 19.95
930619	Black	€ 19.95
930620	Grey	€ 19.95
930621	Red	€ 19.95
930622	Yellow	€ 19.95
930623	Blue	€ 19.95
930624	Green	€ 19.95



PENDANT, MIRAM SERIES

Housing	Aluminium	Height	185 mm
Width	205 mm	Pendulum Length	2190 mm

Article	Housing Color	Price
930625	White	€ 34.95
930626	Black	€ 34.95
930627	Grey	€ 34.95
930628	Red	€ 34.95
930629	Yellow	€ 34.95
930630	Blue	€ 34.95
930631	Green	€ 34.95



SAMAS SOLAR

Need lighting but don't have an available power supply? We have the solution. The SAMAS SOLAR series only needs sunlight - and not even consistent sunlight. Thanks to its clever energy-saving mode, in which it emits just 15 % light output in standby mode, it lasts an impressively long time. When the built-in sensor detects movement, it switches to full light output. The lighting can also be switched off using a button. The powerful light output combined with state-of-the-art technology for long runtimes makes it the perfect solution for walls, tables and gardens.



SAMAS SOLAR

- Motion/twilight sensor
- Highly efficient solar panel
- Includes 3.70 V and 2,200 mAh Li-ion rechargeable battery
- Incl. ground spike

Housing	Aluminium	Power	2.2 W
Colour Temperature	3000 K	Rated Input Voltage	3.7 V/DC
Length	140 mm	Power Supply Unit incl.	No
Width	140 mm	Light Beam Angle	98 Degree
Base Length	100.5 mm	Colour Rendering Index (Ra)	80
Base Width	100.5 mm		
Base Height	22 mm		

Article	Housing Color		Luminous Flux	Height	Price
733050	■ Grey		135 lm	500 mm	€ 149.95
733049	■ Grey		170 lm	340 mm	€ 139.95



SAMAS SOLAR

- Motion/twilight sensor
- Highly efficient solar panel
- Includes 3.70 V and 2,200 mAh Li-ion rechargeable battery



Housing	Aluminium	Base Height	12 mm
Colour Temperature	3000 K	Power	2.2 W
Luminous Flux	130 lm	Rated Input Voltage	3.7 V/DC
Length	154 mm	Power Supply Unit incl.	No
Width	140 mm	Light Beam Angle	106 Degree
Height	290 mm	Colour Rendering Index (Ra)	80
Base Length	110 mm		
Base Width	30 mm		

Article	Housing Color		Price
731122	■ Grey		€ 139.95





STANDING LIGHT SOLAR PREMIUM

The SOLAR PREMIUM series features an impressive futuristic design and provides both innovative and decorative lighting outdoors and in gardens. Power is supplied by a built-in rechargeable battery with solar panel, eliminating the need for unsightly or expensive cable installations.





STANDING LIGHT SOLAR PREMIUM

- Motion/twilight sensor
- highly efficient solar panel
- includes 3.70 V and 2,200 mAh Li-ion rechargeable battery
- tilting lamp head

Housing	Aluminium	Base Height	4.5 mm
Colour Temperature	3200 K	Power	1.6 W
Luminous Flux	170 lm	Rated Input Voltage	3.7 V/DC
Length	200 mm	Power Supply Unit incl.	No
Width	151 mm	Light Beam Angle	110 Degree
Height	1000 mm	Swivelling Angle	180 Degree
Base Length	80 mm	Colour Rendering Index (Ra)	80
Base Width	151 mm		

Article	Housing Color		Price
733046	Grey	WW	€ 219.95

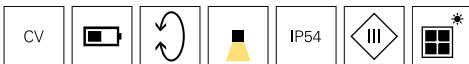

SOLAR PREMIUM

- Motion/twilight sensor
- Highly efficient solar panel
- Includes 3.70 V and 2,200 mAh Li-ion rechargeable battery
- Tilting lamp head

Housing	Aluminium	Power	1.6 W
Colour Temperature	3200 K	Rated Input Voltage	3.7 V/DC
Luminous Flux	170 lm	Power Supply Unit incl.	No
Length	160.5 mm	Light Beam Angle	110 Degree
Width	233.2 mm	Swivelling Angle	180 Degree
Height	152 mm	Colour Rendering Index (Ra)	80
Base Length	160.5 mm		
Base Height	80.5 mm		

Article	Housing Color		Price
731116	Grey	WW	€ 149.95





OUTDOOR LIGHTS

- 402 bollard lights
- 424 surface mounted wall lights
- 454 ceiling and wall lights
- 458 built in wall lights
- 464 spherical lamps
- 468 energy distributor
- 478 surface mounted and ground spike lights
- 490 wall washer
- 494 ground recessed lights
- 516 floodlight
- 522 display lights



bollard lights



page 404



page 404



page 405



page 406



page 408



page 410



page 412



page 414



page 416



page 418



page 420



page 422





ESTADA

Housing	Stainless steel	Max. Power	1x max. 11 W
Height	1000 mm	Rated Input Voltage	220-240 V/AC
Ø	100 mm	Control	Dimmable via optional light source
Base Ø	170 mm		



Article	Housing Color	Price
730009	 Silver	€ 119.95



NOVA

•E27 socket suitable for A19 LED lamps

Housing	Stainless steel	Max. Power	1x max. 40 W
Height	1100 mm	Rated Input Voltage	220-240 V/AC
Ø	75 mm	Colour of Light Output	White
Base Ø	110 mm		

Article	Housing Color	Dimmable	Control	Motion Detector	Type of Motion Detector	Price
730032	 Silver			Yes	Infrared	€ 99.95
730007	 Silver	Yes	Dimmable via optional light source	No		€ 79.95





ZILLY

·swivelling lamp head

Housing	Stainless steel	Rated Input Voltage	220-240 V/AC
Base Height	7 mm	Control	Dimmable via optional light source
Base Ø	100 mm		

Article	Housing Color	Length	Width	Max. Power	Price
733062	Silver	500 mm	140 mm	1x max. 10.0 W	€ 89.95
733063	Silver	1000 mm	232 mm	2x max. 10.0 W	€ 129.95



page 426

page 427



Light sources

For all lights and bases:

You can find the right light sources in the »Light sources« section.



FACADO II ANGULAR

Our FACADO series bollard lights feature IP65 degree of protection for excellent weather resistance. Choose between an opal diffuser or a transparent diffuser with smoked glass to suit your requirements. The series is available in two different sizes (650 mm/1,000 mm) and features an E27 socket for replaceable lamps. The newly designed lamp head provides even better illumination. The FACADO light is made from high-quality die-cast aluminium and available in dark grey or rust and in square or rounded designs.

The IP67 connection box features a double M20 cable gland suitable for buried cables in sizes 3× 1.5 mm², 5× 1.5 mm² or 3× 2.5 mm², and more.





FACADO II ANGULAR

- IP65 weather resistance
- IP67 connection box suitable for buried cables 3x 1.5 mm²/5x 1.5 mm²/3x 2.5 mm², and more
- newly designed lamp head for improved illumination
- available with an opal diffuser or a transparent diffuser with smoked glass
- ideal for e.g. ST64 bulbs and A60/70 bulbs

Housing	Aluminium, Polycarbonate	Max. Power	1x max. 20 W
Surface	Matt	Rated Input Voltage	220-240 V/AC
Length	108 mm	Control	Dimmable via optional light source
Width	108 mm		

Article	Housing Color	Height	Colour of Light Output	Price
730496	Dark grey	650 mm	Smoke-coloured	€ 149.95
730495	Dark grey	650 mm	White	€ 149.95
730497	Dark grey	1000 mm	Smoke-coloured	€ 199.95
730498	Dark grey	1000 mm	White	€ 199.95



Accessories

180359 MAS VLE E27 ST64 4 W 1,800 K gold-coloured



€ 39.95

180361 CLA150 E27 DIM 18 W 3,300 K, matt



€ 27.95



Accessories

Cables, plugs, clamps and more:
You can find the right mounting accessories in the »Accessories« section.



FACADO II ANGULAR

Our FACADO series bollard lights feature IP65 degree of protection for excellent weather resistance. Choose between an opal diffuser or a transparent diffuser with smoked glass to suit your requirements. The series is available in two different sizes (650 mm/1,000 mm) and features an E27 socket for replaceable lamps. The newly designed lamp head provides even better illumination. The FACADO light is made from high-quality die-cast aluminium and available in dark grey or rust and in square or rounded designs.

The IP67 connection box features a double M20 cable gland suitable for buried cables in sizes 3× 1.5 mm², 5× 1.5 mm² or 3× 2.5 mm², and more.





FACADO II ROUND

- IP65 weather resistance
- IP67 connection box suitable for buried cables 3x 1.5 mm²/5x 1.5 mm²/ 3x 2.5 mm², and more
- newly designed lamp head for improved illumination
- available with an opal diffuser or a transparent diffuser with smoked glass
- ideal for e.g. ST64 bulbs and A60/70 bulbs

Housing	Aluminium, Polycarbonate	Max. Power	1x max. 20 W
Surface	Matt	Rated Input Voltage	220-240 V/AC
Ø	108 mm	Control	Dimmable via optional light source

Article	Housing Color	Height	Colour of Light Output	Price
730499	Dark grey	650 mm	Smoke-coloured	€ 149.95
730501	Rust	650 mm	Smoke-coloured	€ 149.95
730500	Dark grey	650 mm	White	€ 149.95
730502	Rust	650 mm	White	€ 149.95
730503	Dark grey	1000 mm	Smoke-coloured	€ 199.95
730505	Rust	1000 mm	Smoke-coloured	€ 199.95
730504	Dark grey	1000 mm	White	€ 199.95
730506	Rust	1000 mm	White	€ 199.95



Accessories

180359 MAS VLE E27 ST64 4 W 1,800 K gold-coloured



€ 39.95

180361 CLA150 E27 DIM 18 W 3,300 K, matt



€ 27.95



Accessories

Cables, plugs, clamps and more:
You can find the right mounting accessories in the »Accessories« section.

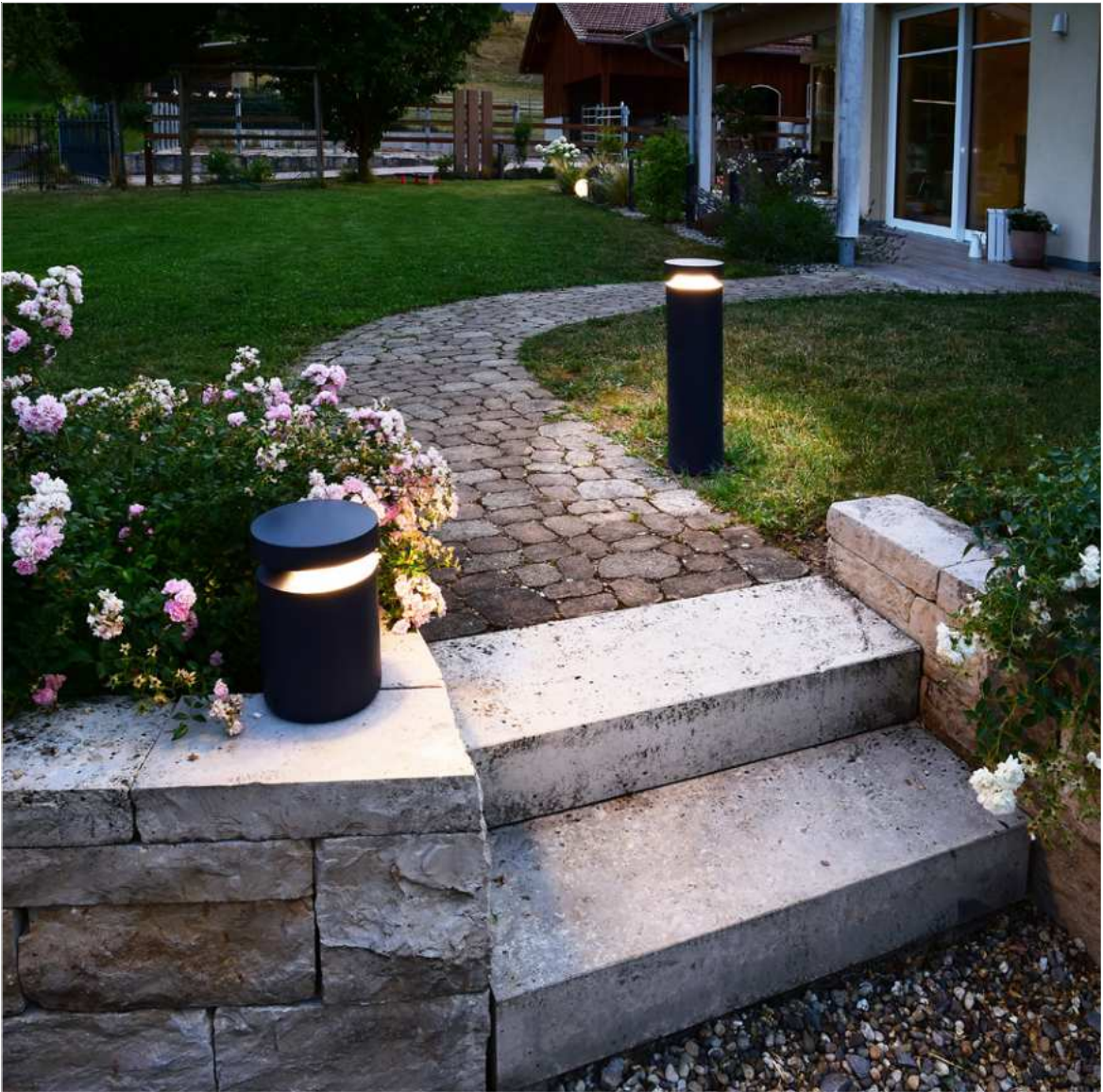

FARO

The solid FARO bollard lights made from die-cast aluminium are available in the sizes 25, 60 and 100 cm. Their design [more than 97 % of light directed downwards] and lens optics allow glare-free light distribution and a particularly large light beam of up to 10 metres in diameter. All variants are also DALI2 DT6 compatible. The FARO models can be equipped with an optional screening shade to illuminate surfaces on one side only. The IP68 connection box with possible feed-through wiring and the dirt-repellent powder coating in DB703 make the FARO bollard lights a long-lasting and high-quality choice for your outdoor lighting.





FARO

- Glare-free, light directed downwards (>97 %)
- Lens optics for wide homogeneous illumination with up to 4/7/10 m diameter
- Optional screening shade for darkening on one side
- IP68 connection box with feed-through wiring
- Particularly high-quality and solid construction
- Dirt-repellent powder coating in DB703
- Emergency power capable (180-264V/DC EOFI: 100%)

Housing	Aluminium	Light Beam Angle	360 Degree
Colour Temperature	3000 K	Light Beam Angle 2	180 Degree
Luminous Flux	1030 lm	Control	DALI 2 / DT6
Ø	180 mm	Colour Rendering Index (Ra)	80
Power	24 W	IK Protection Class	IK10
Rated Input Voltage	180-264V/AC		
Power Supply Unit incl.	Yes		

Article	Housing Color		Height	Price
730492	Grey		250 mm	€ 429.95
730493	Grey		600 mm	€ 499.95
730494	Grey		1000 mm	€ 579.95



Accessories

- 930731** Concrete anchor for series Faro **€ 24.95**
- 930776** Shield cover 180 degree for series Faro **€ 9.95**



Technical data sheet

New in the onlineshop: The technical data sheets offer even more information: Light and energy data, light distribution curves, dimensional drawings and more.



LERNA

LERNA series bollard lights offer a number of advantages. The ability to adjust the light colour in two stages (3,000 K/4,000 K) allows you to choose the colour temperature that sets the perfect ambience. The downward orientation of the lighting also fully guarantees efficient illumination without accumulating dirt. LERNA series bollard lights are available in two different sizes (600 mm and 1,000 mm). With a power rating of 7,4 W and 256 lm, the light itself is incredibly bright.





LERNA

- Light colour adjustable in two stages
- Light directed fully downwards to prevent dirt accumulating

Housing	Aluminium	Power Supply Unit incl.	Yes
Colour Temperature	3000/4000 K	Light Beam Angle	50 Degree
Luminous Flux	237/256 lm	Light Beam Angle 2	100 Degree
Length	120 mm	Colour Rendering Index (Ra)	80
Width	100 mm	IK Protection Class	IK06
Power	7.4 W		
Rated Input Voltage	200-240 V/AC		

Article	Housing Color		Height	Price
733073	Grey	ww nw	600 mm	€ 199.95
733072	Grey	ww nw	1000 mm	€ 249.95



Accessories

Cables, plugs, clamps and more:
You can find the right mounting accessories in the »Accessories« section.



CATA

The CATA series impresses not only as a modern path light, but also as a standalone lighting and design feature when creating outdoor spaces. The LEDs not only ensure full-surface illumination of paths and entrance areas but also inevitably draw attention to the striking frame construction. Available in three sizes, the CATA IV models can also be combined really well.





CATA

Housing	Aluminium	Power	4 W
Colour Temperature	3000 K	Rated Input Voltage	100-240 V/AC
Luminous Flux	170 lm	Power Supply Unit incl.	Yes
Length	151 mm	Light Beam Angle	120 Degree
Width	61 mm	Primary Connection End	Connection box IP65
Base Length	145 mm	Colour Rendering Index (Ra)	80
Base Width	55 mm		
Base Height	20 mm		

Article	Housing Color		Height	Price
733040	■ Grey	ww	500 mm	€ 189.95
733041	■ Grey	ww	700 mm	€ 209.95
733042	■ Grey	ww	1000 mm	€ 235.95



Accessories

Cables, plugs, clamps and more:
You can find the right mounting accessories in the »Accessories« section.

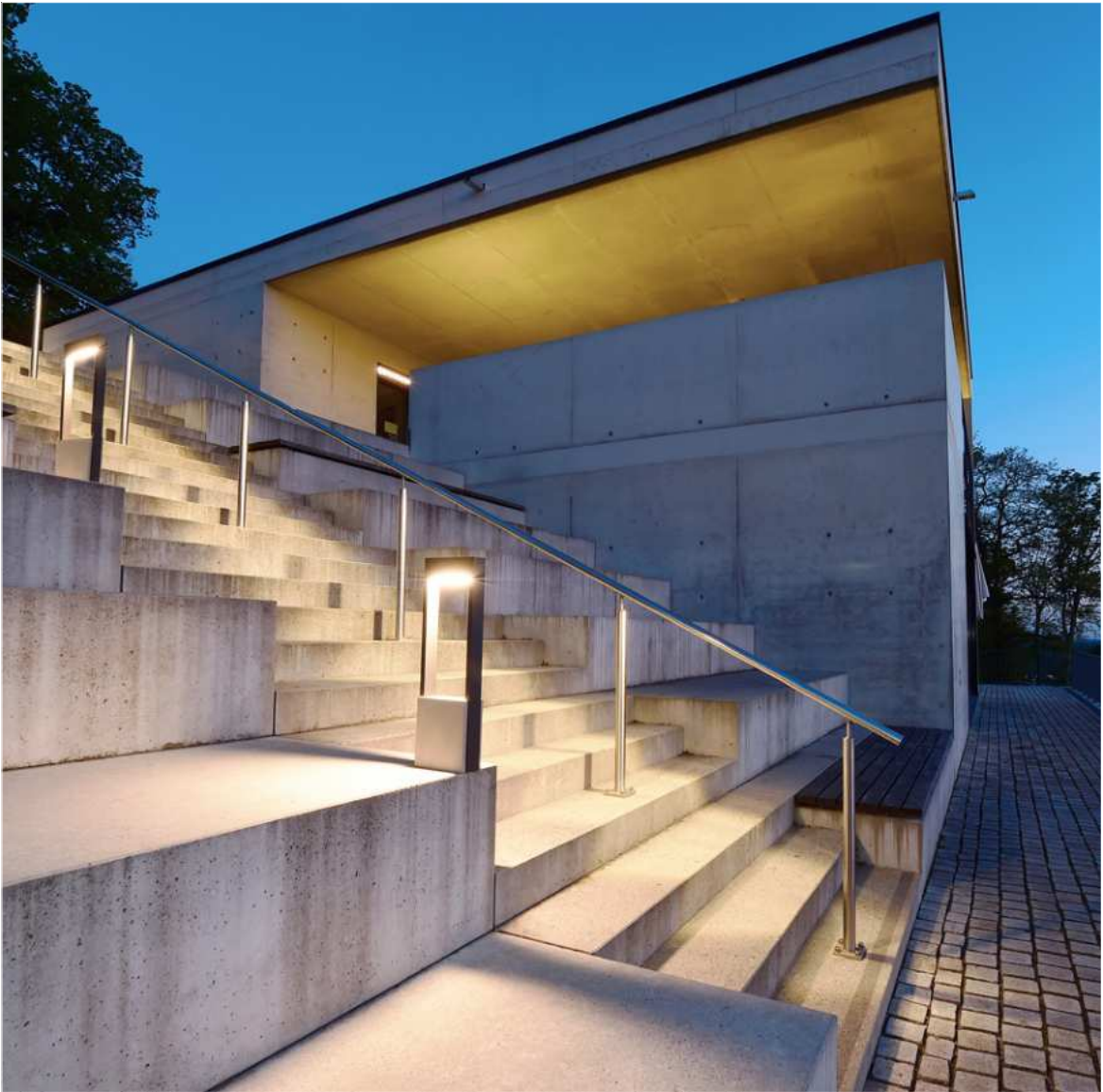

CHERTAN

With its extraordinary mix of materials consisting of die-cast aluminium housing and base made of weather-resistant, fibreglass-reinforced concrete, the CHERTAN outdoor standing light certainly stands apart from other models just on looks alone. With its pleasantly warm white light and light emission angle of 120°, the outdoor light is perfectly suited for decorative use in entrance areas, on paths or in the garden.

Note: As concrete is a natural product, every surface is unique and forms a distinct patina over time, depending on local conditions. It is therefore normal in wet conditions for a blotchy surface to form that disappears again when dried, yet produces an individual patina over the long-term.







CHERTAN

·Fibreglass-reinforced and weather-resistant concrete base

Housing	Aluminium	Rated Input Voltage	100-277 V/AC
Colour Temperature	3000 K	Power Supply Unit incl.	Yes
Length	170 mm	Light Beam Angle	120 Degree
Width	72 mm	Primary Connection End	Connection box IP54
Base Length	160 mm	Colour Rendering Index (Ra)	90
Base Width	30 mm		
Base Height	40 mm		
Power	13 W		

Article	Housing Color	Luminous Flux	Height	Price
733043	■ Grey 	480 lm	450 mm	€ 199.95
733044	■ Grey 	530 lm	600 mm	€ 219.95
733045	■ Grey 	640 lm	1000 mm	€ 239.95



Accessories

Cables, plugs, clamps and more:
You can find the right mounting accessories in the »Accessories« section.



ORTIS

The ORTIS LED bollard light cuts an excellent figure anywhere with its dark grey aluminium housing and is suitable for flexible outdoor use in gardens, driveways and as a path light thanks to IP54 certification. The Ortis also has an internal louvre insert in the luminaire head, which provides a pleasant, dimmed and downward-directed light (warm white, 3,000 K).





ORTIS

·Light directed downwards, dimmed by the slatted insert

Housing	Aluminium	Power Supply Unit incl.	Yes
Colour Temperature	3000 K	Light Beam Angle	360 Degree
Luminous Flux	510 lm	Primary Connection End	Connection box
Height	1000 mm	Colour Rendering Index (Ra)	80
Ø	120 mm	IK Protection Class	IK05
Power	15.9 W		
Rated Input Voltage	220-240 V/AC		

Article	Housing Color		Price
733004	 Grey		€ 219.95



Accessories

Cables, plugs, clamps and more:
You can find the right mounting accessories in the »Accessories« section.



TUCANAE

With its slim, unfussy housing design, the TUCANAE is a modern outdoor light that can be integrated almost anywhere. The 100-cm-high bollard light emits its warm white light diagonally downwards onto paths and other surfaces and, in the MOTION variant, has an integrated twilight switch with adjustable brightness threshold and operating time.





TUCANAE

- Powerful and energy-saving
- Uniform illumination
- Adjustable brightness threshold and operating time [733068]

Housing	Aluminium	Base Height	10 mm
Colour Temperature	3000 K	Power	18 W
Luminous Flux	1650 lm	Rated Input Voltage	110-240 V/AC
Length	206 mm	Power Supply Unit incl.	Yes
Width	180 mm	Light Beam Angle	110 Degree
Height	1000 mm	Primary Connection End	Connection box
Base Length	120 mm	Colour Rendering Index (Ra)	80
Base Width	180 mm		

Article	Housing Color		IP Protection Type	Motion Detector	Type of Motion Detector	Price
733068	■ Grey		IP 54	Yes	Infrared	€ 279.95
733069	■ Grey		IP 65	No		€ 249.95



Accessories

Cables, plugs, clamps and more:
You can find the right mounting accessories in the »Accessories« section.



ALHENA



The modern, towering ALHENA light with 360° light distribution not only lights up entrances, parking spaces, gardens and patios, it also stands apart as a design element owing to its surface-mounted design.



ALHENA

- High luminous flux
- Homogeneous light distribution in all directions
- Powerful statement for expressive outdoor spaces

Housing	Aluminium	Light Beam Angle	360 Degree
Colour Temperature	3000 K	Primary Connection End	Connection box
Ø	110 mm		IP65
Rated Input Voltage	220-240 V/AC	Colour Rendering Index (Ra)	80
Power Supply Unit incl.	Yes		

Article	Housing Color	Luminous Flux	Height	Base Ø	Power	Price
733057	■ Anthracite 	2965 lm	900 mm	130 mm	29.0 W	€ 219.95
733058	■ Anthracite 	3900 lm	1500 mm	110 mm	37.0 W	€ 299.95



Accessories

Cables, plugs, clamps and more:
You can find the right mounting accessories in the »Accessories« section.



surface mounted wall lights



□
page 426



□
page 426



□
page 427



■
page 428



■ ■
page 429



■
page 430



■
page 431



■
page 432



■
page 433



■
page 434



■
page 435



■ ■ □
page 436



■ ■ ■ ■
page 436



■
page 437



□ ■
page 438



□ ■
page 439



■
page 440



■
page 441



■
page 442



■
page 443



■
page 444



■ ■
page 446



■
page 447



■
page 448



■
page 449



■
page 450



■
page 451



□ ■
page 452



NOVA

·Motion/twilight sensor

Housing	Stainless steel	Base Ø	110 mm
Width	145 mm	Max. Power	1x max. 40 W
Height	388 mm	Rated Input Voltage	220-240 V/AC
Ø	75 mm	Colour of Light Output	White
Base Height	25 mm		

Article	Housing Color	Price
730034	Silver	€ 79.95



page 404



ZILLY

Housing	Stainless steel	Base Width	43 mm
Width	60 mm	Base Height	22 mm
Height	105 mm	Rated Input Voltage	220-240 V/AC
Ø	60 mm	Control	Dimmable via optional light source
Base Length	102 mm		

Article	Housing Color	Length	Max. Power	Price
731008	Silver	125 mm	1x max. 35.0 W	€ 54.95
731010	Silver	175 mm	2x max. 35.0 W	€ 89.95





ZILLY MOTION

Housing	Stainless steel	Base Width	70 mm
Height	108 mm	Base Height	25 mm
Ø	60 mm	Rated Input Voltage	220-240 V/AC
Base Length	150 mm	Type of Motion Detector	Infrared

Article	Housing Color	Length	Width	Max. Power	Price
731009	<input type="checkbox"/> Silver	150 mm	68 mm	1x max. 35.0 W	€ 84.95
731011	<input type="checkbox"/> Silver	216 mm	70 mm	2x max. 35.0 W	€ 104.95



page 405



Light sources

For all lights and bases:

You can find the right light sources in the »Light sources« section.



FACADO II ANGULAR

- Feed-through wiring possible
- Mounting plate can be disconnected via plug
- Quick and secure installation
- IP65 weather resistance
- Newly designed lamp head for improved illumination

Housing	Aluminium, Polycarbonate	Height	261.5 mm
Surface	Matt	Max. Power	1x max. 20 W
Length	148 mm	Rated Input Voltage	220-240 V/AC
Width	108 mm	Control	Dimmable via optional light source

Article	Housing Color	Colour of Light Output	Price
731151	■ Dark grey	Smoke-coloured	€ 124.95
731157	■ Dark grey	White	€ 124.95



Accessories

180361 CLA150 E27 DIM 18 W 3,300 K, matt  **€ 27.95**

180359 MAS VLE E27 ST64 4 W 1,800 K gold-coloured  **€ 39.95**





FACADO II ROUND

- Feed-through wiring possible
- Mounting plate can be disconnected via plug
- rapid and secure installation
- Weather protection with IP65
- Newly designed lamp head for improved illumination

Housing	Aluminium, Polycarbonate	Ø	108 mm
Surface	Matt	Max. Power	1x max. 20 W
Length	144 mm	Rated Input Voltage	220-240 V/AC
Height	261.5 mm	Control	Dimmable via optional light source

Article	Housing Color	Colour of Light Output	Price
731153	Dark grey	Smoke-coloured	€ 124.95
731155	Rust	Smoke-coloured	€ 124.95
731154	Dark grey	White	€ 124.95
731156	Rust	White	€ 124.95



Accessories

180361 CLA150 E27 DIM 18 W 3,300 K, matt



€ 27.95

180359 MAS VLE E27 ST64 4 W 1,800 K gold-coloured



€ 39.95





ORTIS

Housing	Aluminium	Base Width	77 mm
Colour Temperature	3000 K	Base Height	67 mm
Luminous Flux	510 lm	Power	15.9 W
Length	260 mm	Rated Input Voltage	220-240 V/AC
Width	120 mm	Power Supply Unit incl.	Yes
Height	181 mm	Light Beam Angle	360 Degree
Ø	120 mm	Colour Rendering Index (Ra)	80
Base Length	100 mm		

Article	Housing Color		Price
731031	 Grey		€ 189.95

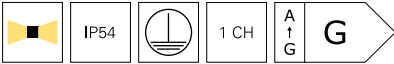

page 418



Accessories

Cables, plugs, clamps and more:

You can find the right mounting accessories in the »Accessories« section.



TUCANAE

- Modern minimalist design
- Powerful and energy saving
- Uniform illumination
- Adjustable brightness threshold and operating time

Housing	Aluminium	Base Height	15 mm
Colour Temperature	3000 K	Power	18 W
Luminous Flux	1650 lm	Rated Input Voltage	110-240 V/AC
Length	140 mm	Power Supply Unit incl.	Yes
Width	172 mm	Light Beam Angle	110 Degree
Height	219 mm	Colour Rendering Index (Ra)	80
Base Length	125 mm		
Base Width	135 mm		

Article	Housing Color		IP Protection Type	Motion Detector	Price
731133	■ Grey	ww	IP 54	Yes	€ 189.95
731144	■ Grey	ww	IP 65	No	€ 179.95



Accessories

180512 BASIC, CC, CC35018/18W



€ 23.95





SAIPH

Over 100 years of proven lighting design meets modern amenities with these classic outdoor light. The timeless surface-mounted wall light of the SAIPH awakens memories of iconic designs from various decades and impresses with valuable genuine glass that is not only scratch-resistant but also resilient to weather and UV.



SAIPH

- Retro look
- exchangeable lamp E27 (retrofit)
- Weather and UV-resilient genuine glass

Housing	Aluminium	Max. Power	1x max. 60 W
Length	170 mm	Rated Input Voltage	220-240 V/AC
Width	149 mm	Control	Dimmable via optional light source
Height	280 mm		

Article	Housing Color	Price
341244	 Black	€ 54.95



SARGAS

- Retro look
- exchangeable lamp E27 (retrofit)
- Weather and UV-resilient genuine glass

Housing	Aluminium	Max. Power	1x max. 60 W
Length	178 mm	Rated Input Voltage	220-240 V/AC
Width	151 mm	Control	Dimmable via optional light source
Height	318 mm		

Article	Housing Color	Price
341245	 Black	€ 54.95





MOBBY

The MOBBY II is a modern IP55 surface-mounted wall light for outdoor use - optionally available as a SINGLE version with downward-directed light emission or as a DOUBLE version with light emission on both sides. The warm white light [3,000 K] of the compact MOBBY II creates a pleasant, inviting ambience on house walls, pillars and other areas.



MOBBY

Housing	Aluminium	Rated Input Voltage	220-240 V/AC
Colour Temperature	3000 K	Power Supply Unit incl.	Yes
Length	84 mm	Light Beam Angle	53 Degree
Width	124 mm	Control	Leading-edge dimmer, Trailing-edge dimmer
Ø	84 mm	Colour Rendering Index (Ra)	80
Base Length	120 mm		
Base Width	80 mm		
Base Height	34 mm		

Article	Housing Color	Luminous Flux	Height	Power	Light Direction	Price
731072	Black	810 lm	120 mm	9.9 W	Below	€ 199.95
731071	Black	1620 lm	220 mm	19.9 W	Top / Below	€ 299.95

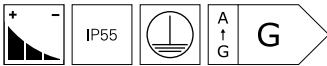

ACHERNAR

·Exchangeable lamp GU10 (retrofit)

Housing	Aluminium	Rated Input Voltage	220-240 V/AC
Height	95 mm	Control	Dimmable via optional light source
Ø	63 mm		

Article	Housing Color	Length	Base Length	Base Width	Max. Power	Price
731130	Black	108 mm			1x max. 50.0 W	€ 44.95
731131	Black	158 mm	125 mm	135 mm	2x max. 35.0 W	€ 54.95





CUBODO

Housing	Aluminium	Base Height	20 mm
Colour Temperature	3000 K	Power	5.7 W
Luminous Flux	270 lm	Rated Input Voltage	220-240 V/AC
Length	90 mm	Power Supply Unit incl.	Yes
Width	110 mm	Light Beam Angle	80 Degree
Height	90 mm	Light Beam Angle 2	40 Degree
Base Length	59 mm	Colour Rendering Index (Ra)	80
Base Width	59 mm		

Article	Housing Color		Price
730328	Dark grey		€ 124.95
730329	Brown		€ 124.95
730380	White		€ 124.95

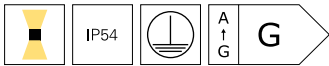

CUBODO II

Housing	Aluminium	Base Width	108 mm
Colour Temperature	3000 K	Rated Input Voltage	220-240 V/AC
Length	108 mm	Power Supply Unit incl.	Yes
Width	108 mm	Colour Rendering Index (Ra)	80
Height	115 mm		
Base Length	108 mm		

Article	Housing Color		Luminous Flux	Power	Light Beam Angle	Light Beam Angle 2	Light Direction	Price
731024	Dark grey		600 lm	8.5 W	19 Degree		Below	€ 154.95
731025	Silver		600 lm	8.5 W	19 Degree		Below	€ 154.95
731026	White		600 lm	8.5 W	19 Degree		Below	€ 154.95
731019	Silver		1260 lm	15.7 W	19 Degree	19 Degree	Top / Below	€ 174.95
731020	White		1260 lm	15.7 W	19 Degree	19 Degree	Top / Below	€ 174.95
731015	Grey		1300 lm	16.0 W	25 Degree	25 Degree	Top / Below	€ 174.95





CUBODO II MINI

Housing	Aluminium	Base Height	20 mm
Colour Temperature	3000 K	Rated Input Voltage	220-240 V/AC
Length	90 mm	Power Supply Unit incl.	Yes
Width	68 mm	Light Beam Angle	46 Degree
Base Length	65 mm	Colour Rendering Index (Ra)	77
Base Width	65 mm		

Article	Housing Color		Luminous Flux	Height	Power Light Direction	Price
731029	Grey	ww	220 lm	70 mm	5.0 W Below	€ 114.95
731030	Grey	ww	440 lm	108 mm	9.9 W Top / Below	€ 144.95





CAN IP65

- customised lighting solution thanks to replaceable light source
- can be combined with the product family of the CAN series

Housing	Aluminium	Max. Power	1x max. 7.5 W
Length	87 mm	Rated Input Voltage	220-240 V/AC
Height	108 mm	Control	Dimmable via optional light source
Ø	80 mm		

Article	Housing Color	Price
731223	<input type="checkbox"/> White	€ 59.95
731224	<input checked="" type="checkbox"/> Black	€ 59.95



page 51



page 88



page 88



page 90



page 91



page 278



page 364



Light sources

For all lights and bases:

You can find the right light sources in the »Light sources« section.



CAN UP & DOWN IP65

- customised lighting solution thanks to replaceable light source
- can be combined with the product family of the CAN series

Housing	Aluminium	Max. Power	2x max. 7.5 W
Length	87 mm	Rated Input Voltage	220-240 V/AC
Height	212 mm	Control	Dimmable via optional light source
Ø	80 mm		

Article	Housing Color	Price
731225	<input type="checkbox"/> White	€ 89.95
731226	<input checked="" type="checkbox"/> Black	€ 89.95



page 51



page 88



page 88



page 90



page 91



page 278



page 364



Light sources

For all lights and bases:

You can find the right light sources in the »Light sources« section.



JABBAH

- Dimmable to 60 % using DIP switch
- High luminous flux

Housing	Aluminium	Power	25 W
Colour Temperature	3000 K	Rated Input Voltage	220-240 V/AC
Luminous Flux	1850 lm	Power Supply Unit incl.	Yes
Length	150 mm	Light Beam Angle	75 Degree
Width	150 mm	Colour Rendering Index (Ra)	80
Height	150 mm		

Article Housing Color Price

731127  Grey  € **329.95**





ANCHA

Housing	Aluminium	Base Height	83 mm
Colour Temperature	3000 K	Rated Input Voltage	220-240 V/AC
Length	80 mm	Power Supply Unit incl.	Yes
Width	92 mm	Light Beam Angle	113 Degree
Base Length	74 mm	Colour Rendering Index (Ra)	80
Base Width	74 mm		

Article	Housing Color		Luminous Flux	Height	Power	Light Direction	IK Protection Class	Price
731087	Grey	ww	260 lm	97 mm	6.0 W	Below		€ 94.95
731088	Grey	ww	530 lm	105 mm	11.5 W	Top / Below	IK04	€ 124.95



Accessories

Cables, plugs, clamps and more:
You can find the right mounting accessories in the »Accessories« section.

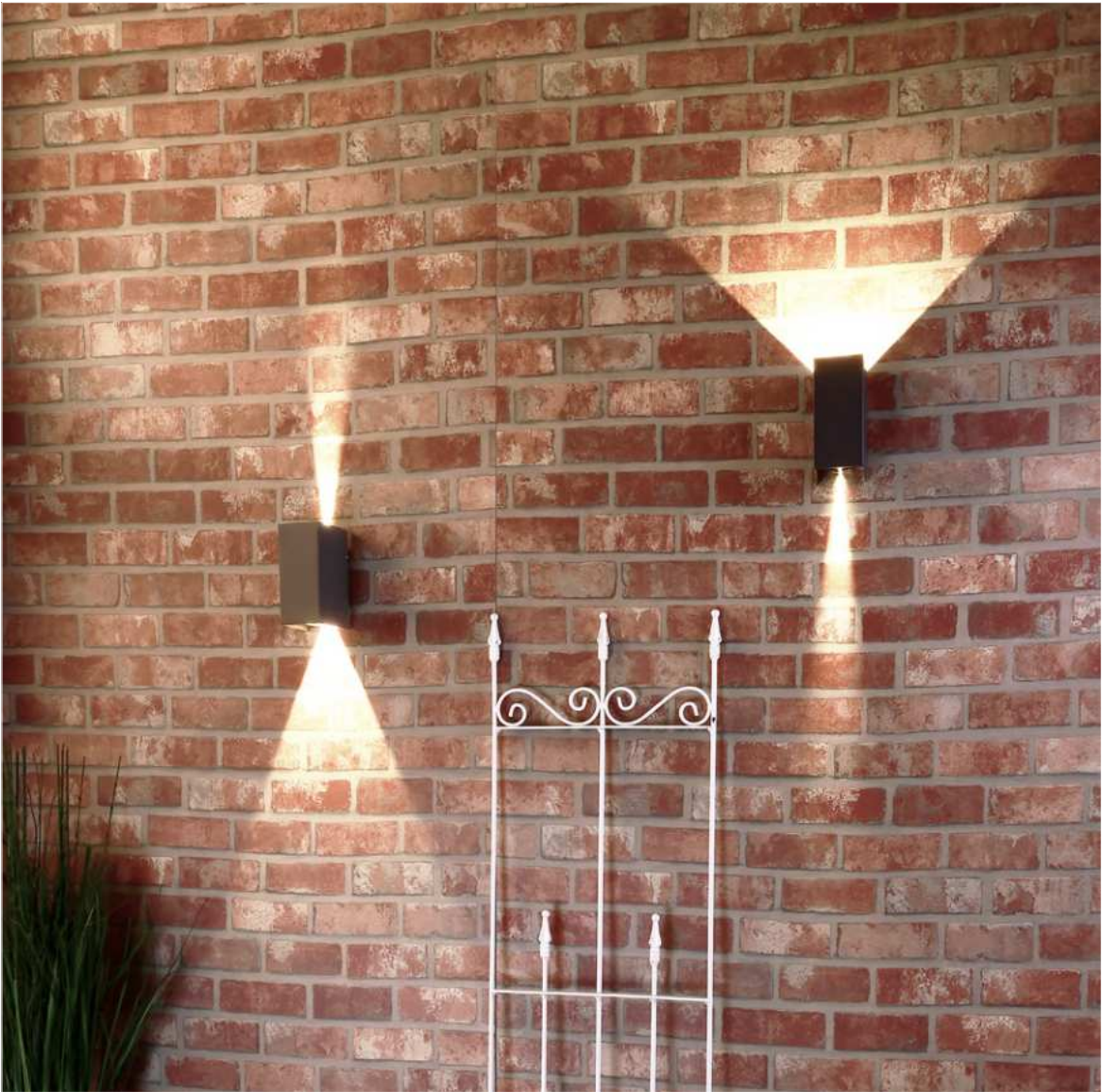

ARCTURUS

The ARCTURUS LED wall-mounted light has a modern cube design [optionally also elongated] and is suitable for flexible lighting outdoors. Using an integrated shutter, the light emission angle of the IP54 light can be adjusted between 0° and 90° in order to generate a different light pattern depending on the requirements of the application. Protected in the dark grey die-cast aluminium housing are the two high-power LEDs, which generate 5.5 W of warm white light.





ARCTURUS

·Adjustable light emission angle

Housing	Aluminium	Power Supply Unit incl.	Yes
Colour Temperature	3000 K	Light Beam Angle	90 Degree
Power	6 W	Colour Rendering Index (Ra)	80
Rated Input Voltage	220-240 V/AC		

Article	Housing Color	Luminous Flux	Length	Width	Height	Base Length	Price
731099	■ Grey	200 lm	79 mm	110 mm	172 mm	68 mm	€ 109.95
731100	■ Grey	208 lm	140 mm	105 mm	145 mm	75 mm	€ 109.95

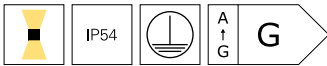

WALL LINE

Housing	Aluminium	Base Width	70 mm
Length	250 mm	Max. Power	1x max. 18 W
Width	110 mm	Rated Input Voltage	220-240 V/AC
Height	110 mm	Control	Dimmable via optional light source
Base Length	100 mm		

Article	Housing Color	Price
731060	■ Grey	€ 79.95





LINEAR 250

Housing	Aluminium	Base Height	15 mm
Colour Temperature	3000 K	Rated Input Voltage	220-240 V/AC
Length	250 mm	Power Supply Unit incl.	Yes
Width	60 mm	Light Beam Angle	100 Degree
Height	60 mm	Colour Rendering Index (Ra)	80
Base Length	242 mm		
Base Width	53 mm		

Article	Housing Color	Luminous Flux	Power	Light Direction	Price
731135	Grey	600 lm	8.0 W	Below	€ 149.95
731136	Grey	1155 lm	14.0 W	Top / Below	€ 184.95



LINEAR 500

Housing	Aluminium	Base Height	15 mm
Colour Temperature	3000 K	Rated Input Voltage	220-240 V/AC
Length	500 mm	Power Supply Unit incl.	Yes
Width	60 mm	Light Beam Angle	100 Degree
Height	60 mm	Colour Rendering Index (Ra)	80
Base Length	493 mm		
Base Width	53 mm		

Article	Housing Color	Luminous Flux	Power	Light Direction	EEL	Price
731134	Grey	1230 lm	14.0 W	Below		€ 194.95
731129	Grey	1760 lm	20.0 W	Top / Below		€ 214.95



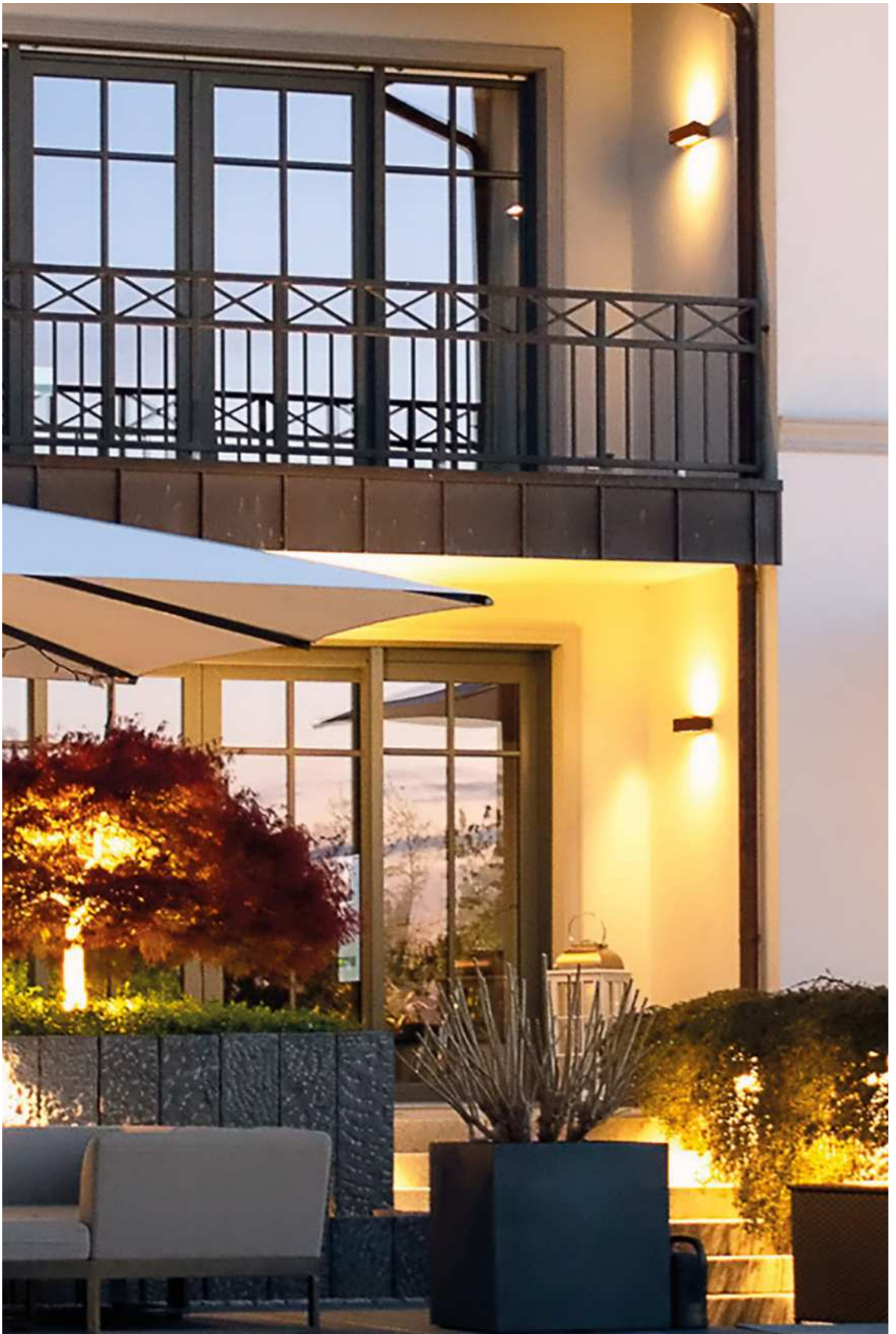





RILONGO

Housing	Aluminium	Max. Power	1x max. 18 W
Length	250 mm	Rated Input Voltage	220-240 V/AC
Width	110 mm	Control	Dimmable via optional light source
Height	103 mm	Colour of Light Output	White
Base Length	250 mm		
Base Width	110 mm		

Article	Housing Color	Price
730330	 Grey	€ 79.95
730331	 Brown	€ 79.95





URIA

Housing	Aluminium	Base Height	85 mm
Colour Temperature	3000 K	Power	11.2 W
Luminous Flux	408 lm	Rated Input Voltage	220-240 V/AC
Length	300 mm	Power Supply Unit incl.	Yes
Width	97 mm	Light Beam Angle	120 Degree
Height	120 mm	Colour Rendering Index (Ra)	80
Base Length	270 mm		
Base Width	20 mm		

Article	Housing Color		Price
731033	 Grey		€ 114.95





ALKES

The ALKES series is not a traditional wall-mounted light but reminds you of a floodlight with its SMD-LED panel. The highlight: the upper housing part is tilted forwards 45° from the façade to direct the warm white light in a targeted manner onto the surface to be illuminated. In addition, the ALKES also looks great when switched off with its modern design and rounded edges.



ALKES

- high luminous efficacy
- homogeneous light distribution

Housing	Aluminium	Light Beam Angle	110 Degree
Colour Temperature	3000 K	Colour Rendering Index (Ra)	80
Rated Input Voltage	220-240 V/AC		
Power Supply Unit incl.	Yes		

Article	Housing Color		Luminous Flux	Length	Width	Height	Power	Price
731138	■ Grey	ww	920 lm	200 mm	126 mm	184 mm	21.0 W	€ 99.95
731140	■ Grey	ww	1720 lm	297 mm	165 mm	240 mm	36.0 W	€ 169.95



ALKES MOTION

- high luminous efficacy
- homogeneous light distribution

Housing	Aluminium	Light Beam Angle	110 Degree
Colour Temperature	3000 K	Colour Rendering Index (Ra)	80
Rated Input Voltage	220-240 V/AC		
Power Supply Unit incl.	Yes		

Article	Housing Color		Luminous Flux	Length	Width	Height	Power	Price
731139	■ Grey	ww	735 lm	200 mm	126 mm	184 mm	21.0 W	€ 119.95
731141	■ Grey	ww	1720 lm	297 mm	165 mm	240 mm	36.0 W	€ 189.95

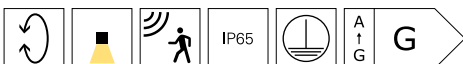



GRUMIUM ANGULAR CCT

Modular, compact, impactful - The GRUMIUM wall-mounted light can be installed on patios, building walls or in entrances to living spaces and, thanks to its optional covers in different designs, provides a flexible universal solution for many areas of application. The permanently installed and energy-saving LEDs delivering max. 10 watts are encompassed by a diffuser made of milky plastic and produce a pleasant warm white light with a luminous flux of 730 lm. The Grumium outdoor light with die-cast aluminium housing comes in an angular and rounded design and has degree of protection IP54.



GRUMIUM ANGULAR CCT

- Can be customised using replaceable add-ons
- Warm white/cold white can be selected using a switch

Housing	Aluminium	Base Ø	195 mm
Colour Temperature	3000/4000 K	Power	10 W
Length	100 mm	Rated Input Voltage	220-240 V/AC
Width	70 mm	Power Supply Unit incl.	Yes
Height	200 mm	Colour Rendering Index (Ra)	80
Base Width	95 mm		
Base Height	15 mm		

Article	Housing Color	Shape		Luminous Flux	Light Beam Angle	Price
620124	Grey	lines diagonal	WW NW	205 lm	138 Degree	€ 109.95
620125	Grey	lines horizontally	WW NW	280 lm	138 Degree	€ 109.95
620126	Grey	lines vertical	WW NW	300 lm	180 Degree	€ 109.95
620127	Grey	upside/below	WW NW	440 lm	150 Degree	€ 109.95
620123	Grey	borders	WW NW	450 lm	138 Degree	€ 109.95



GRUMIUM ROUND

- Can be customised using replaceable add-ons

Housing	Aluminium	Base Ø	195 mm
Colour Temperature	3000 K	Power	10 W
Length	100 mm	Rated Input Voltage	220-240 V/AC
Width	70 mm	Power Supply Unit incl.	Yes
Height	200 mm	Colour Rendering Index (Ra)	80
Base Width	95 mm		
Base Height	15 mm		

Article	Housing Color	Shape		Luminous Flux	Light Beam Angle	Price
620129	Grey	Taille	WW	210 lm	160 Degree	€ 109.95
620130	Grey	lines horizontally	WW	250 lm	160 Degree	€ 109.95
620128	Grey	upside/below	WW	325 lm	180 Degree	€ 109.95





CASA

The CASA house number light has space for up to four digits and/or letters each 10 cm high, ensuring house numbers can be easily read. With a configurable twilight switch, the wall light automatically adjusts to the ambient brightness. The light colour can also be adjusted in two stages [3,000 K/4,000 K].

Multiple cable entries and the option of feed-through wiring mean that installation is simple and flexible. Anti-theft protection also prevents unauthorised removal.









CASA

- Space for four digits and letters each 10 cm high
- Adjustable daylight sensor
- Adjustable light colour 3,000/4,000 K
- Multiple cable entries incl. feed-through wiring
- Easy and quick mounting with anti-theft protection
- Set of number/letter stickers optionally available

Surface	Matt	Rated Input Voltage	200-240 V/AC
Colour Temperature	3000/4000 K	Power Supply Unit incl.	Yes
Length	275 mm	Light Beam Angle	120 Degree
Width	275 mm	Colour Rendering Index (Ra)	80
Height	64 mm	Light Direction	Front
Base Height	14 mm	IK Protection Class	IK08
Base Ø	245 mm		
Power	3 W		

Article	Housing Color	Luminous Flux	Housing	Price
731159	Black  	250/260 lm	PP - Polypropylene	€ 109.95
731158	White  	270/280 lm	Polycarbonate	€ 109.95



Accessories

930807 Set of numbers 0-9 for Casa



€ 10.95

930808 Set of letters A-F for Casa



€ 6.95



■
page 456



■
page 456



■
page 457

ceiling and wall lights







MOB



Housing	Aluminium	Control	Dimmable via optional light source
Max. Power	1x max. 9 W		
Rated Input Voltage	220-240 V/AC		

Article	Housing Color	Length	Width	Height	Ø	Base Length	Price
730408	■ Grey			92 mm	108 mm		€ 69.95
730410	■ Grey	108 mm	108 mm	100 mm		108 mm	€ 81.95



ASCELLA

Housing	Aluminium	Power	30 W
Colour Temperature	3000 K	Rated Input Voltage	220-240 V/AC
Luminous Flux	2300 lm	Power Supply Unit incl.	Yes
Height	50 mm	Light Beam Angle	113 Degree
Base Height	12 mm	Colour Rendering Index (Ra)	80
Base Ø	270 mm		

Article	Housing Color	Length	Width	Ø	Price
348069	■ Grey 			340 mm	€ 249.95
348070	■ Grey 	340 mm	340 mm		€ 249.95







MENSÆ

- Corridor function
- Adjustable motion detector [hold time / detection area]
- Daylight sensor

Housing	Aluminium	Power	16 W
Colour Temperature	3000 K	Rated Input Voltage	100-240 V/AC
Luminous Flux	1400 lm	Power Supply Unit incl.	Yes
Height	54 mm	Colour Rendering Index (Ra)	80
Base Height	28.5 mm	IK Protection Class	IK08
Base Ø	170 mm		

Article	Housing Color	Length	Width	Ø	Light Beam Angle	Price
348072	■ Anthracite 			300 mm	110 Degree	€ 249.95
348071	■ Anthracite 	300 mm	300 mm		115 Degree	€ 249.95





built in wall lights



■
page 460



□ ■ ■
page 461



■
page 462



□ ■ ■
page 463





LIGHT BASE II COB OUTDOOR

Housing	Aluminium	Rated Input Voltage	220-240 V/AC
Colour Temperature	3000 K	Power Supply Unit incl.	Yes
Luminous Flux	55 lm	Installation Depth	70 mm
Length	96 mm	Cut Out Length	95 mm
Width	96 mm	Cut Out Width	95 mm
Height	77 mm	Colour Rendering Index (Ra)	80
Power	1.3 W		

Article	Housing Color		Price
763025	 Grey		€ 99.95





COVER, LIGHT BASE II COB OUTDOOR SERIES

Housing Aluminium Width 100 mm
 Length 100 mm

Article	Housing Color	light output	Height	Price
930414	■ Silver grey	stripe	8 mm	€ 19.95
930419	□ White	stripe	8 mm	€ 19.95
930420	■ Black	stripe	8 mm	€ 19.95
930413	□ White	round	24 mm	€ 19.95
930415	■ Black	linear	24 mm	€ 19.95
930416	□ White	step	24 mm	€ 19.95
930417	■ Silver grey	step	24 mm	€ 19.95
930418	■ Black	step	24 mm	€ 19.95
930421	□ White	linear	24 mm	€ 19.95
930422	■ Silver grey	linear	24 mm	€ 19.95
930423	■ Silver grey	round	24 mm	€ 19.95
930424	■ Black	round	24 mm	€ 19.95



LIGHT BASE III OUTDOOR

Housing	Aluminium	Power Supply Unit incl.	Yes
Colour Temperature	3000 K	Installation Depth	78 mm
Luminous Flux	88 lm	Light Beam Angle	115 Degree
Length	245 mm	Cut Out Length	245 mm
Width	85 mm	Cut Out Width	85 mm
Height	78 mm	Colour Rendering Index (Ra)	90
Power	4.3 W		
Rated Input Voltage	220-240 V/AC		

Article	Housing Color		Price
763026	■ Black	ww	€ 119.95





COVER, LIGHT BASE III OUTDOOR SERIES

Housing Aluminium Width 90 mm
 Length 250 mm

Article	Housing Color	light output	Height	Price
930470	White	stripe	9 mm	€ 59.95
930471	Grey	stripe	9 mm	€ 59.95
930472	Black	stripe	9 mm	€ 59.95
930461	White	step	24 mm	€ 59.95
930468	Grey	step	24 mm	€ 59.95
930469	Black	step	24 mm	€ 59.95
930473	White	angled	24 mm	€ 59.95
930474	Grey	angled	24 mm	€ 59.95
930475	Black	angled	24 mm	€ 59.95
930476	White	rounded	24 mm	€ 59.95
930477	Grey	rounded	24 mm	€ 59.95
930478	Black	rounded	24 mm	€ 59.95



□
page 466

spherical lamps





DORADUS

Light in its most beautiful form - The sphere is and remains one of the most striking of shapes. With the opportunity to illuminate it from within, what could be better. The spherical light looks great both indoors and outdoors. Optimum effect is achieved by using a dimmable LED lamp with RGB or colour change function. Be mesmerized with cosy red, calming green and deep blue. With a warm white lamp too, the light emanating from this spherical light is something rather special.



DORADUS

- Spherical housing, IP65 protection
- Ready to use with 3 m connecting cable
- Incl. ground spike

Housing	Polyethylene	Primary Connection End	Power plug IP44
Sockets	1	Control	Dimmable via optional light source
Max. Power	1x max. 23 W	IP Protection Type Plug	IP 44
Rated Input Voltage	220-240 V/AC		
Primary Cable Length	3 m		

Article	Housing Color	Height	Ø	Price
836011	<input type="checkbox"/> White	230 mm	250 mm	€ 139.95
836930	<input type="checkbox"/> White	350 mm	380 mm	€ 169.95
836014	<input type="checkbox"/> White	420 mm	450 mm	€ 199.95
836931	<input type="checkbox"/> White	530 mm	560 mm	€ 319.95
836958	<input type="checkbox"/> White	750 mm	770 mm	€ 519.25



Light sources

For all lights and bases:
You can find the right light sources in the »Light sources« section.



energy distributor



■
page 470



■
page 472



■
page 474



■
page 476





ARAWAN

Sometimes it's about more than just light. With our multiple socket tower, available with or without lamp, another gap in our range is filled. Design your garden even more flexibly in proven DEKO-LIGHT quality, and of course, at a price that won't break the bank.





ARAWAN

- Safe power distribution outdoors
- Total load max. 3,680 W
- Outlets and light can be switched on separately (only art. no. 733055)
- Connection box with IP67 and accessories included in scope of delivery
- Feed-through wiring possible

Housing	Aluminium	Rated Input Voltage	220-240 V/AC
Ø	100 mm	Primary Connection End	Connection box
Connected Load max.	3680 W		IP67

Article	Housing Color	Colour Temperature	Luminous Flux	Height	Power	Power Supply Unit incl.	EEL	Price
733055	■ Grey			400 mm				€ 119.95
733054	■ Grey	ww 3000 K	150 lm	478 mm	4.8 W	Yes		€ 169.95



Accessories

Cables, plugs, clamps and more:
You can find the right mounting accessories in the »Accessories« section.



PUKA MANA

A garden is pure nature and yet needs power in several different places. With the PUKA MANA, you can flexibly access power to operate lawnmowers and other gardening tools or simply to charge your e-bike or smartphone. The multiple socket tower has two socket outlets and can be installed particularly easily using our multi-outdoor cable connectors. The sophisticated cable routing ensures a clean visual design.





PUKA MANA

- Door can be completely closed when angled plugs are plugged in
- Total load: max. 3,680 W
- Easy to install thanks to IP68 cable connector
- Light can be switched on separately (only art. 733067)

Housing	Aluminium	Connected Load max.	3680 W
Length	100 mm	Rated Input Voltage	220-240 V/AC
Width	100 mm	Primary Connection End	Connection box
Base Length	140 mm		IP67
Base Width	140 mm		

Article	Housing Color	Height	Socket / Base	Max. Power	Price
733066	■ Grey	420 mm			€ 199.95
733067	■ Grey	620 mm	E27	1x max. 13.0 W	€ 259.95



Accessories

Cables, plugs, clamps and more:
You can find the right mounting accessories in the »Accessories« section.



FACADO SOCKET

FACADO series standing lights have been proving quite the hit for some time on paved paths in gardens. Now, the classically elegant outdoor lights are becoming that much more versatile: The FACADO SOCKET contains two electrical outlet points, serving as a practical power distributor in gardens, on patios or on paths. The lamps can also be changed thanks to the E27 base and adapted to the desired lighting atmosphere. The FACADO SOCKET is available in two heights [65 and 100 cm].



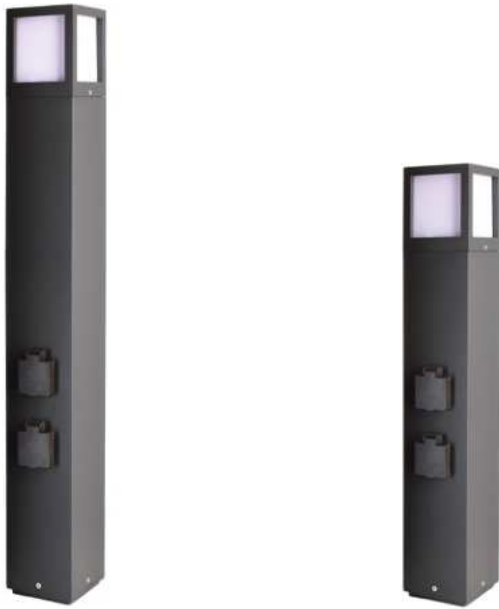

FACADO SOCKET

- Total load max. 3,680 W
- Outlets and light can be switched on separately
- Feed-through wiring possible
- Replaceable light source (E27)

Housing	Aluminium	Max. Power	1x max. 20 W
Width	108 mm	Connected Load max.	3680 W
Height	108 mm	Rated Input Voltage	220-240 V/AC

Article	Housing Color	Length	Price
733064	Dark grey	650 mm	€ 199.95
733065	Dark grey	1000 mm	€ 219.95



Light sources

For all lights and bases:
You can find the right light sources in the »Light sources« section.



LERNA

LERNA series power distributors offer a number of advantages. With two sockets and a total load of 3,680 W, they allow you to connect various devices while providing reliable lighting. The socket cover latches open for additional convenience. The ability to adjust the light colour in 2 stages (3,000 K/4,000 K) allows you to choose the colour temperature that sets the perfect ambience. The downward orientation of the lighting also fully guarantees efficient illumination without creating light pollution. LERNA series bollard lights are available in two different sizes (600 mm and 1,000 mm). With a power rating of 6 W and 516 lm, the light itself is incredibly bright.





LERNA

- Socket cover latches open
- Total socket output: 3,680 W
- Light colour adjustable in two stages
- Light directed fully downwards to prevent light pollution

Housing	Aluminium	Rated Input Voltage	200-240 V/AC
Colour Temperature	3000/4000 K	Power Supply Unit incl.	Yes
Luminous Flux	237/256 lm	Light Beam Angle	50 Degree
Length	120 mm	Light Beam Angle 2	100 Degree
Width	100 mm	Colour Rendering Index (Ra)	80
Power	7.4 W	IK Protection Class	IK06
Connected Load max.	3680 W		

Article	Housing Color		Height	Price
733071	■ Grey	ww nw	600 mm	€ 259.95
733070	■ Grey	ww nw	1000 mm	€ 299.95



Accessories

Cables, plugs, clamps and more:
You can find the right mounting accessories in the »Accessories« section.



surface mounted / ground spike lights



■
page 480



■
page 482



■
page 482



■
page 484



■
page 485



■
page 486



■
page 487



■
page 488



■
page 489





DEKO-LIGHT RF-SMART SPOTLIGHT RGB+CCT RF + ZIGBEE

The RF-Smart SPOT ground spike spotlight offers dimmable brightness and colour saturation, as well as 16 million colours and adjustable colour temperatures. With 8 pre-installed automatic programmes and the ability to synchronise with other RF-Smart components, this spotlight offers maximum flexibility. Controllable via RF-smart radio remote controls (2.4 GHz, range approx. 30 m, not included) as well as all Zigbee 3.0 compatible controls and apps such as Amazon Echo (Alexa), Google Assistant and Tuya (corresponding gateway required). The very narrow beam angle makes it ideal for column lighting and similar applications.





DEKO-LIGHT RF-SMART SPOTLIGHT RGB+CCT RF + ZIGBEE

- Brightness and colour saturation can be adjusted
- 16 million available colours and adjustable colour temperature
- 18 automatic programmes pre-installed
- Programme and remote control synchronisation when operating multiple RF-smart components (repeater function)
- Can be controlled with RF-smart wireless remote controls (2.4 GHz, range approx. 30 m, not included in the scope of delivery)
- Can be controlled with all Zigbee 3.0 compatible controllers/apps such as Amazon Echo (Alexa), Google Assistant, Tuya (relevant gateway required, outdoor range up to 100 m)
- Very narrow light emission angle, optimal for column lighting or similar

Housing	Aluminium, Plastic	Light Beam Angle	15 Degree
Colour Temperature	2700-6500 K	Swivelling Angle	355 Degree
Luminous Flux	1700 lm	Control	RF-Smart, ZigBee
Length	170 mm		3.0
Width	65 mm	Primary Cable Length	1.5 m
Height	180 mm	Colour Rendering Index (Ra)	80
Power	25 W	Light Direction	Front
Rated Input Voltage	100-240 V/AC	IP Protection Type Plug	IP 44
Power Supply Unit incl.	Yes		

Article	Housing Color	Colour Temperature	Price
843521	■ Anthracite	RGB WW CW 2700-6500 K	€ 239.95



Accessories

843510	RF-smart, remote control, white, 1 zone, RGB/RGBW/RGB+CCT, IP20		€ 38.95
843511	RF-smart, remote control, black, 1 zone, RGB/RGBW/RGB+CCT, IP20		€ 38.95
843512	RF-smart, remote control, black, 8 zones, Single/CCT/RGB/RGBW/RGB+CCT		€ 49.95
843513	RF-smart, wall remote control, white, 3V, 4 zones, Single/CCT/RGB/W/+CCT		€ 69.95
843522	RF-smart, wall remote control, white, 230V, 4 zones, Single/CCT/RGB/W/+CCT		€ 74.95
843514	RF-smart, wall remote control, white, 8 zones, Single/CCT/RGB/RGBW/RGB+CCT		€ 109.95
930659	Wall bracket/display arm, metal, black, 800 mm		€ 59.95



SPIKY

- Exchangeable lamp GU10 (retrofit)
- incl. 2 m connecting cable with IP44 plug
- Including ground spike
- incl. cover (art. no. 732161 only)

Housing	Aluminium, Plastic	Control	Dimmable via optional light source
Surface	Matt		
Max. Power	1x max. 35 W	Swivelling Angle	180 Degree
Rated Input Voltage	220-240 V/AC	IP Protection Type Plug	IP 44
Primary Connection End	Power plug		

Article	Housing Color	Height	Ø	Primary Cable Length	Price
732161	Grey	345 mm	100 mm	2.5 m	€ 34.95
732160	Grey	420 mm	60 mm	2 m	€ 39.95



KEID

Housing	Aluminium	Light Beam Angle	45 Degree
Colour Temperature	3000 K	Swivelling Angle	180 Degree
Length	120 mm	Primary Cable Length	0.5 m
Height	457 mm	Primary Connection End	Connection box
Ø	75 mm		IP65
Rated Input Voltage	220-240 V/AC	Colour Rendering Index (Ra)	80
Power Supply Unit incl.	Yes		

Article	Housing Color	Luminous Flux	Power	Price
732094	Grey	800 lm	10.3 W	€ 139.95
732095	Grey	1350 lm	21.5 W	€ 149.95





With the kind support of Licht von Klein / licht-von-klein.de



COLT 4W COB



- replaceable reflectors
- including clear/frosted glass pane
- including honeycomb filter
- Feed-through wiring possible

Housing	Aluminium	Power Supply Unit incl.	Yes
Colour Temperature	3000 K	Light Beam Angle	36 Degree
Luminous Flux	240 lm	Swivelling Angle	180 Degree
Length	65 mm	Control	Leading-edge dimmer, Trailing-edge dimmer
Height	120 mm	Primary Cable Length	2 m
Ø	50 mm	Primary Connection End	Power plug IP44
Base Height	2.5 mm	Colour Rendering Index (Ra)	80
Base Ø	65 mm	IP Protection Type Plug	IP 44
Power	4 W		
Rated Input Voltage	220-240 V/AC		

Article	Housing Color		Price
732104	■ Black	ww	€ 139.95



Accessories

930428	Lense 15° for series Colt 4W		€ 5.95
930430	Lense 60° for series Colt 4W		€ 5.95
930426	Ground spike for series Colt 4/8W, M5		€ 9.95



Accessories

Cables, plugs, clamps and more:

You can find the right mounting accessories in the »Accessories« section.



COLT COB RGB

- replaceable reflectors
- including clear/frosted glass pane
- including honeycomb filter
- Feed-through wiring possible

Housing	Aluminium	Rated Input Voltage	24 V/DC
Colour Temperature	2700 K	Power Supply Unit incl.	No
Luminous Flux	92 lm	Light Beam Angle	20 Degree
Height	65 mm	Swivelling Angle	45 Degree
Ø	50 mm	Control	Dimmable via optional controller
Base Height	7 mm	Colour Rendering Index (Ra)	80
Base Ø	65 mm		
Power	3.2 W		

Article	Housing Color		Price
732134	Black	RGB WW	€ 199.95



Accessories

862230 OCTO, CV, Mini 24V/12W



€ 21.95

930426 Ground spike for series Colt 4/8W, M5

€ 9.95



Accessories

Cables, plugs, clamps and more:
You can find the right mounting accessories in the »Accessories« section.



COLT 8W COB + 8W RGBW



- replaceable reflectors
- including clear/frosted glass pane
- including honeycomb filter [only article 732108]
- Feed-through wiring possible

Housing	Aluminium	Height	185 mm
Colour Temperature	3000 K	Swivelling Angle	180 Degree



Article	Housing Color	Luminous Flux	light beam angle	Length	Ø	Base Height	Base Ø	Price
732127	Black	389 lm	20°	66 mm	78 mm	50.3 mm	96 mm	€ 299.95
732108	Black	470 lm	40°	65 mm	76.5 mm	50 mm	95 mm	€ 199.95







Accessories

- 930441** Surface-mounted housing for series Colt 8W  € 59.95
- 930426** Ground spike for series Colt 4/8W, M5  € 9.95

Accessories for **732108**

- 930431** Reflector 12° for series Colt 8W  € 8.95
- 930432** Reflector 22° for series Colt 8W  € 8.95
- 930587** Connection cable with 230V power plug  € 19.95

Accessories for **732127**

- 843003** DMX wall controller Art-9 RGB/RGBW  € 234.95
- 862122** FLAT, CV, UT24V/50W  € 52.95
- 862230** OCTO, CV, Mini 24V/12W  € 21.95
- 872083** IP, CV, V6-40-24  € 74.95



COLT 15W COB + 16W RGBW



- replaceable reflectors
- including clear/frosted glass pane
- including honeycomb filter [only article 732109]
- Feed-through wiring possible

Housing	Aluminium	Base Height	56 mm
Colour Temperature	3000 K	Base Ø	120 mm
Height	220 mm	Swivelling Angle	180 Degree



Article	Housing Color	Luminous Flux	light beam angle	Length	Ø	Power	Rated Input Voltage	Price
732128	Black	780 lm	20°	88 mm	110 mm	16.0 W	24 V/DC	€ 449.95
732109	Black	1090 lm	40°	88.3 mm	110.5 mm	14.0 W	240 V/AC	€ 249.95









Accessories

- 930442** Surface-mounted housing for series Colt 15/30W  € 69.95
- 930427** Ground spike for series Colt 15/25//30/36/65W, M10  € 11.95

Accessories for **732109**

- 930434** Reflector 12° for series Colt 15W  € 10.95
- 930435** Reflector 22° for series Colt 15W  € 11.95
- 930587** Connection cable with 230V power plug  € 19.95

Accessories for **732128**

- 843003** DMX wall controller Art-9 RGB/RGBW  € 234.95
- 862122** FLAT, CV, UT24V/50W  € 52.95
- 862164** BASIC, CV, Q8H-24-75W  € 74.95
- 872083** IP, CV, V6-40-24  € 74.95
- 872085** IP, CV, V6-75-24  € 94.95
- 930426** Ground spike for series Colt 4/8W, M5  € 9.95



COLT 30W COB + 25W RGBW



- replaceable reflectors
- including clear/frosted glass pane
- including honeycomb filter [only article 732110]
- Feed-through wiring possible

Housing	Aluminium	Base Height	56 mm
Colour Temperature	3000 K	Base Ø	120 mm
Height	260 mm	Swivelling Angle	180 Degree
Ø	131 mm		



Article	Housing Color	Luminous Flux	light beam angle	Length	Power	Rated Input Voltage	Price
732129	Black	1140 lm	20°	112 mm	25.0 W	24 V/DC	€ 499.95
732110	Black	2320 lm	40°	111.8 mm	29.0 W	220-240 V/AC	€ 289.95









Accessories

- 930442** Surface-mounted housing for series Colt 15/30W  **€ 69.95**
- 930427** Ground spike for series Colt 15/25//30/36/65W, M10  **€ 11.95**

Accessories for **732110**

- 930437** Reflector 12° for series Colt 30W  **€ 12.95**
- 930438** Reflector 22° for series Colt 30W  **€ 12.95**
- 930587** Connection cable with 230V power plug  **€ 19.95**

Accessories for **732129**

- 843003** DMX wall controller Art-9 RGB/RGBW  **€ 234.95**
- 862163** BASIC, CV, Q8H-24-40W  **€ 46.95**
- 862164** BASIC, CV, Q8H-24-75W  **€ 74.95**
- 872083** IP, CV, V6-40-24  **€ 74.95**
- 872085** IP, CV, V6-75-24  **€ 94.95**
- 872094** IP, CV, V6-100-24  **€ 114.95**



COLT 36W RGBWW

- replaceable reflectors
- including clear/frosted glass pane
- including honeycomb filter
- Feed-through wiring possible

Housing	Aluminium	Rated Input Voltage	24 V/DC
Colour Temperature	2700 K	Power Supply Unit incl.	Yes
Luminous Flux	1500 lm	Light Beam Angle	20 Degree
Length	162 mm	Swivelling Angle	90 Degree
Height	192 mm	Control	Dimmable via optional controller
Ø	182 mm	Colour Rendering Index (Ra)	80
Base Height	65 mm		
Base Ø	160 mm		
Power	36 W		

Article	Housing Color		Price
732137	Black		€ 679.95



Accessories

930558	Surface-mounted housing for series Colt 65W COB / 36W RGBW		€ 89.95
843003	DMX wall controller Art-9 RGB/RGBW		€ 234.95
862163	BASIC, CV, Q8H-24-40W		€ 46.95
862164	BASIC, CV, Q8H-24-75W		€ 74.95
862168	BASIC, CV, Q8H-24-150W		€ 129.95
872083	IP, CV, V6-40-24		€ 74.95
872085	IP, CV, V6-75-24		€ 94.95
872087	IP, CV, V6-150-24		€ 149.95
872094	IP, CV, V6-100-24		€ 114.95



■
page 492



■
page 493

wall washer







WALLWASHER CAPH 24 V

·incl. 0.5 m connection cable with WEIPU plug

Housing	Aluminium	Power Supply Unit incl.	No
Colour Temperature	3000 K	Control	Dimmable via optional controller
Length	1000 mm	Primary Cable Length	0.5 m
Width	53.36 mm	Primary Connection End	WEIPU plug 5-pole
Height	81.07 mm	Colour Rendering Index (Ra)	80
Power	60 W		
Rated Input Voltage	24 V/DC		

Article	Housing Color		Luminous Flux	Light Beam Angle	Light Beam Angle 2	Light Distribution	Price
732072	■ Grey		2480 lm	40 Degree	15 Degree	Asymmetric	€ 399.95
732071	■ Grey		2800 lm	25 Degree		Symmetric	€ 399.95

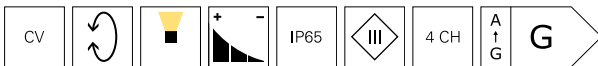

Accessories

862164 BASIC, CV, Q8H-24-75W



€ 74.95

872085 IP, CV, V6-75-24



€ 94.95

843059 RF Color & White remote



€ 119.95

843502 RF-smart, Starter-Set RGB/W/CCT, 12-48V, 20A remote control, IP20 incl.



€ 99.95



WALLWASHER CAPH 230V

·Including 2 m connecting cable with IP44 shaped plug

Housing	Aluminium	Power Supply Unit incl.	Yes
Colour Temperature	3000 K	Primary Cable Length	2 m
Length	1000 mm	Primary Connection End	Power plug IP44
Width	53.36 mm	Colour Rendering Index (Ra)	80
Height	81.07 mm	IP Protection Type Plug	IP 44
Power	38 W		
Rated Input Voltage	220-240 V/AC		

Article	Housing Color		Luminous Flux	Light Beam Angle	Light Beam Angle 2	Light Distribution	Price
732080	■ Grey	ww	2580 lm	40 Degree	15 Degree	Asymmetric	€ 399.95
732079	■ Grey	ww	3000 lm	25 Degree		Symmetric	€ 399.95





ground recessed lights



□
page 496



□
page 496



□
page 497



□
page 498



□
page 499



□
page 500



□
page 501



□
page 501



□
page 502



□
page 503



□
page 504



□
page 505



□
page 506



□
page 507



□
page 507



□
page 508



□
page 509



□
page 509



□
page 510



■
page 511



□
page 512



□
page 512



■
page 514



ATON

Housing	Stainless steel, Aluminium	Rated Input Voltage	220-240 V/AC
Height	111 mm	Cut Out Ø	70 mm
Installation Depth	148 mm	Control	Dimmable via optional light source
Max. Power	1x max. 7 W		

Article	Housing Color	Length	Width	Ø	Price
730474	Silver			97 mm	€ 54.95
730475	Silver	97 mm	97 mm		€ 54.95



PAVO

·Swivelling insert

Housing	Stainless steel, Aluminium	Rated Input Voltage	220-240 V/AC
Height	156 mm	Cut Out Ø	100 mm
Installation Depth	193 mm	Control	Dimmable via optional light source
Max. Power	1x max. 9 W	Swivelling Angle	25 Degree

Article	Housing Color	Length	Width	Ø	Price
730478	Silver			160 mm	€ 109.95
730479	Silver	160 mm	160 mm		€ 109.95





ALZIRR

·Including 1 m connecting cable with WEIPU plug

Housing	Stainless steel, Aluminium	Light Beam Angle	30 Degree
Colour Temperature	3000 K	Cut Out Ø	48 mm
Luminous Flux	150 lm	Control	Dimmable via optional controller
Height	82.5 mm	Colour Rendering Index (Ra)	80
Ø	55 mm	Primary Cable Length	1 m
Power	2.4 W	Primary Connection End	WEIPU plug 2-pole
Rated Input Voltage	24 V/DC	Light Distribution	Symmetric
Power Supply Unit incl.	No		
Installation Depth	98 mm		

Article	Housing Color		Price
730470	Silver		€ 109.95

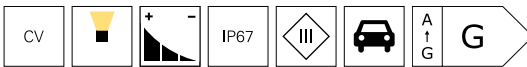

Accessories

862230 OCTO, CV, Mini 24V/12W

€ 21.95

872083 IP, CV, V6-40-24

€ 74.95

843501 RF-smart, Starter-Set LED Single/CCT, 12-48V, 20A remote control incl.

€ 99.95



Accessories

Cables, plugs, clamps and more:
You can find the right mounting accessories in the »Accessories« section.



FORNAC

- Asymmetrical
- Including 1 m connecting cable with WEIPU plug

Housing	Stainless steel, Aluminium	Light Beam Angle	45 Degree
Colour Temperature	3000 K	Light Beam Angle 2	35 Degree
Luminous Flux	110 lm	Cut Out Ø	48 mm
Height	80 mm	Control	Dimmable via optional controller
Ø	55 mm	Colour Rendering Index (Ra)	80
Power	2.7 W	Primary Cable Length	1 m
Rated Input Voltage	24 V/DC	Primary Connection End	WEIPU plug 2-pole
Power Supply Unit incl.	No	Light Distribution	Asymetric
Installation Depth	98 mm		

Article	Housing Color		Price
730447	Silver		€ 119.95

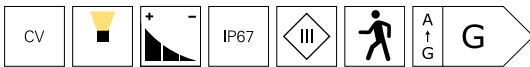

Accessories

862230	OCTO, CV, Mini 24V/12W		€ 21.95
872083	IP, CV, V6-40-24		€ 74.95
843501	RF-smart, Starter-Set LED Single/CCT, 12-48V, 20A remote control incl.		€ 99.95



Accessories

Cables, plugs, clamps and more:
You can find the right mounting accessories in the »Accessories« section.



EASY COB

·Including 1 m connecting cable with WEIPU plug

Housing	Stainless steel, Aluminium	Light Beam Angle	24 Degree
Colour Temperature	3000 K	Cut Out Ø	53 mm
Luminous Flux	330 lm	Control	Dimmable via optional controller
Height	95.5 mm	Colour Rendering Index (Ra)	80
Power	5.5 W	Primary Connection End	WEIPU plug 2-pole
Rated Input Voltage	24 V/DC	Light Distribution	Symmetric
Power Supply Unit incl.	No		
Installation Depth	132.5 mm		

Article	Housing Color	Length	Width	Ø	Primary Cable Length	Price
730469	Silver			70 mm	0.5 m	€ 159.95
730468	Silver		66 mm	66 mm	1 m	€ 159.95



Accessories

862230	OCTO, CV, Mini 24V/12W		€ 21.95
872083	IP, CV, V6-40-24		€ 74.95
843501	RF-smart, Starter-Set LED Single/CCT, 12-48V, 20A remote control incl.		€ 99.95



Accessories

Cables, plugs, clamps and more:
You can find the right mounting accessories in the »Accessories« section.



PEACOCK

·Including 0.5 m connecting cable with protected connection socket

Housing	Stainless steel, Aluminium	Installation Depth	48 mm
Colour Temperature	3000 K	Light Beam Angle	30 Degree
Luminous Flux	150 lm	Cut Out Ø	44 mm
Height	43 mm	Colour Rendering Index (Ra)	80
Ø	58 mm	Primary Connection End	Connection box
Power	2 W		IP67
Rated Input Voltage	220-240 V/AC	IK Protection Class	IK08
Power Supply Unit incl.	Yes	Light Distribution	Symmetric

Article	Housing Color		Price
730459	<input type="checkbox"/> Silver	www	€ 109.95

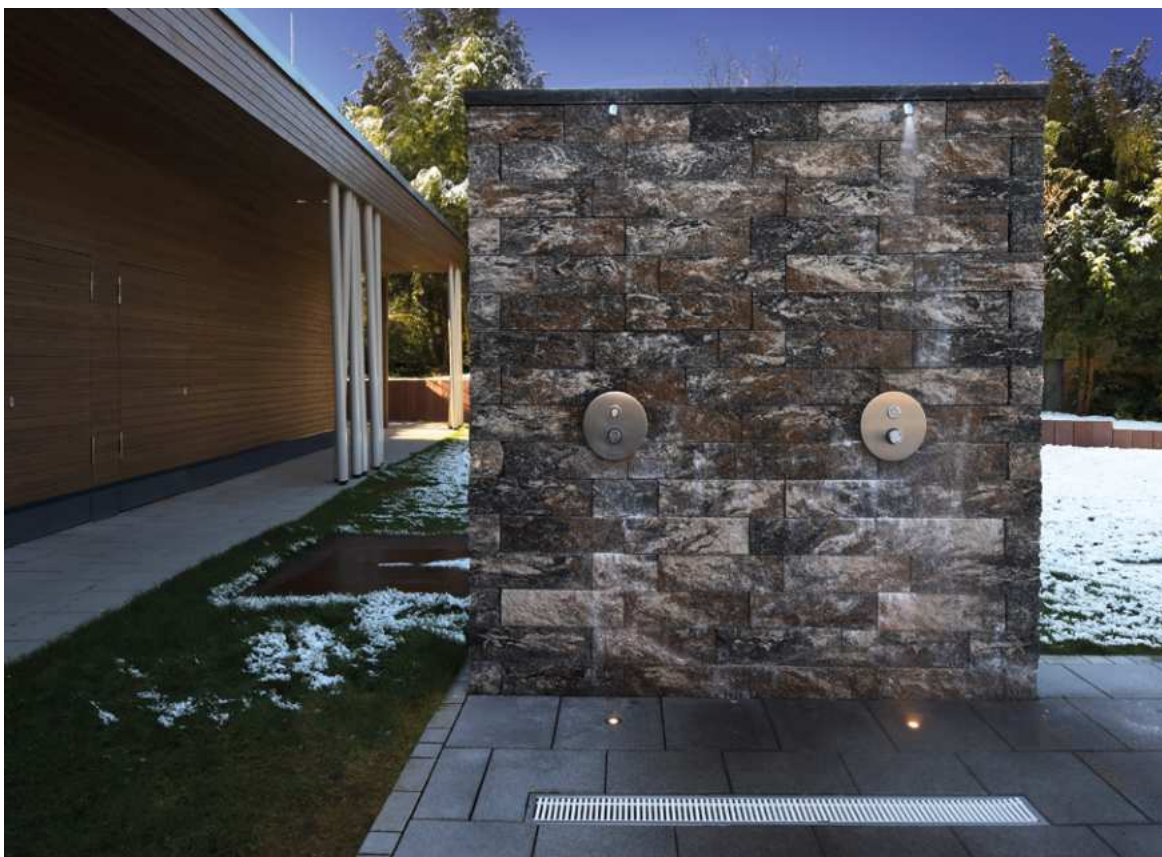



FLAT 24V

Housing	Stainless steel, Aluminium	Installation Depth	50 mm
Luminous Flux	510 lm	Light Beam Angle	30 Degree
Height	38 mm	Cut Out Ø	150 mm
Ø	173 mm	Control	Dimmable via optional controller
Power	17 W	Primary Cable Length	0.5 m
Rated Input Voltage	24 V/DC	Primary Connection End	WEIPU plug 4-pole
Power Supply Unit incl.	No	Light Distribution	Symmetric

Article	Housing Color	Price
100116	Silver	€ 309.95

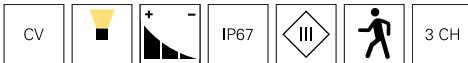

Accessories

872083	IP, CV, V6-40-24		€ 74.95
843502	RF-smart, Starter-Set RGB/W/CCT, 12-48V, 20A remote control, IP20 incl.		€ 99.95



FLAT 230V 20 DEGREE

·Including 0.5 m connecting cable

Housing	Stainless steel, Aluminium	Colour Rendering Index (Ra)	80
Colour Temperature	3000 K	Primary Cable Length	0.5 m
Rated Input Voltage	220-240 V/AC	Primary Connection End	Connection box
Power Supply Unit incl.	Yes	Light Distribution	Symmetric
Light Beam Angle	20 Degree		

Article	Housing Color	Luminous Flux	Ø cut out	Height	Ø	Power	Installation Depth	Price
100111	Silver	400 lm	105 mm	44 mm	116 mm	5.8 W	44 mm	€ 189.95
100114	Silver	860 lm	150 mm	42 mm	173 mm	12.2 W	42 mm	€ 269.95

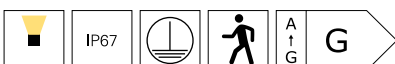



FLAT 230V 120 DEGREE

Housing	Stainless steel, Aluminium	Installation Depth	43 mm
Colour Temperature	3000 K	Light Beam Angle	120 Degree
Luminous Flux	25 lm	Cut Out Ø	100 mm
Height	42 mm	Colour Rendering Index (Ra)	65
Ø	116 mm	Primary Cable Length	0.5 m
Power	1.3 W	Primary Connection End	Connection box
Rated Input Voltage	220-240 V/AC	Light Distribution	Symmetric
Power Supply Unit incl.	Yes		



Article	Housing Color		Price
730336	<input type="checkbox"/> Silver	www	€ 149.95





CANUM 24V SYMMETRICAL

Housing	Stainless steel, Aluminium	Light Beam Angle	45 Degree
Colour Temperature	3000 K	Cut Out Ø	102 mm
Luminous Flux	370 lm	Control	Dimmable via optional controller
Height	102 mm	Colour Rendering Index (Ra)	80
Ø	116 mm	Primary Cable Length	2 m
Power	5.8 W	Primary Connection End	WEIPU plug 2-pole
Rated Input Voltage	24 V/DC	Light Distribution	Symmetric
Power Supply Unit incl.	No		
Installation Depth	150 mm		

Article	Housing Color		Price
100133	 Silver		€ 189.95

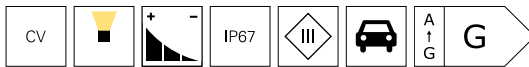

Accessories

862230 OCTO, CV, Mini 24V/12W



€ 21.95

872083 IP, CV, V6-40-24



€ 74.95

843501 RF-smart, Starter-Set LED Single/CCT, 12-48V, 20A remote control incl.



€ 99.95



5-year guarantee

Benefit from the maximum quality promise:

All DEKO-LIGHT brand products come with a five-year manufacturer's guarantee.



CANUM 24V ASYMMETRICAL

- Including 0.5 m connecting cable with WEIPU plug
- Asymmetrical

Housing	Stainless steel, Aluminium	Light Beam Angle	45 Degree
Colour Temperature	3000 K	Light Beam Angle 2	35 Degree
Luminous Flux	800 lm	Cut Out Ø	157 mm
Height	111 mm	Control	Dimmable via optional controller
Ø	173 mm	Colour Rendering Index (Ra)	80
Power	14 W	Primary Cable Length	0.5 m
Rated Input Voltage	24 V/DC	Primary Connection End	WEIPU plug 2-pole
Power Supply Unit incl.	No	Light Distribution	Asymetric
Installation Depth	153 mm		

Article	Housing Color		Price
730296	<input type="checkbox"/> Silver		€ 259.95

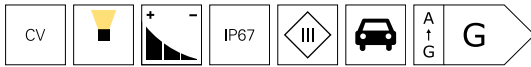

Accessories

872083 IP, CV, V6-40-24



€ 74.95

843501 RF-smart, Starter-Set LED Single/CCT, 12-48V, 20A remote control incl.



€ 99.95



Accessories

Cables, plugs, clamps and more:

You can find the right mounting accessories in the »Accessories« section.



CANUM RGB 24V SYMMETRICAL

Housing	Stainless steel, Aluminium	Installation Depth	150 mm
Luminous Flux	280 lm	Light Beam Angle	30 Degree
Height	102 mm	Cut Out Ø	102 mm
Ø	116 mm	Control	Dimmable via optional controller
Power	7.4 W	Primary Cable Length	0.5 m
Rated Input Voltage	24 V/DC	Primary Connection End	WEIPU plug 4-pole
Power Supply Unit incl.	No	Light Distribution	Symmetric

Article	Housing Color		Price
730276	 Silver		€ 209.95



Accessories

872083 IP, CV, V6-40-24



€ 74.95

843502 RF-smart, Starter-Set RGB/W/CCT, 12-48V, 20A remote control, IP20 incl.



€ 99.95



Accessories

Cables, plugs, clamps and more:
You can find the right mounting accessories in the »Accessories« section.



CANUM RGB 24V ASYMMETRICAL

•Including 0.5 m connecting cable with WEIPU plug

Housing	Stainless steel, Aluminium	Light Beam Angle	50 Degree
Luminous Flux	510 lm	Light Beam Angle 2	35 Degree
Height	111 mm	Cut Out Ø	157 mm
Ø	173 mm	Control	Dimmable via optional controller
Power	16.9 W	Primary Cable Length	0.5 m
Rated Input Voltage	24 V/DC	Primary Connection End	WEIPU plug 4-pole
Power Supply Unit incl.	No	Light Distribution	Asymetric
Installation Depth	153 mm		

Article	Housing Color		Price
730454	<input type="checkbox"/> Silver		€ 349.95



Accessories

872083 IP, CV, V6-40-24



€ 74.95

843502 RF-smart, Starter-Set RGB/W/CCT, 12-48V, 20A remote control, IP20 incl.



€ 99.95



Accessories

Cables, plugs, clamps and more:

You can find the right mounting accessories in the »Accessories« section.



CANUM 230V SYMMETRICAL

·Including connecting cable

Housing	Stainless steel, Aluminium	Installation Depth	150 mm
Colour Temperature	3000 K	Light Beam Angle	30 Degree
Luminous Flux	280 lm	Cut Out Ø	102 mm
Height	102 mm	Colour Rendering Index (Ra)	80
Ø	116 mm	Primary Cable Length	0.5 m
Power	4.1 W	Primary Connection End	Connection box
Rated Input Voltage	220-240 V/AC	Light Distribution	Symmetric
Power Supply Unit incl.	Yes		

Article	Housing Color		Price
730255	Silver	WW	€ 179.95



CANUM 230V ASYMMETRICAL

·Asymmetrical

·Including 0.5 m connecting cable

Housing	Stainless steel, Aluminium	Light Beam Angle	45 Degree
Colour Temperature	3000 K	Light Beam Angle 2	35 Degree
Luminous Flux	700 lm	Cut Out Ø	157 mm
Height	111 mm	Colour Rendering Index (Ra)	80
Ø	173 mm	Primary Cable Length	0.5 m
Power	11.9 W	Primary Connection End	Connection box
Rated Input Voltage	220-240 V/AC	IK Protection Class	IK09
Power Supply Unit incl.	Yes	Light Distribution	Asymetric
Installation Depth	153 mm		

Article	Housing Color		Price
730289	Silver	WW	€ 259.95





SOFT FLEX

- Including 1 m connecting cable
- Including honeycomb filter

Housing	Stainless steel, Aluminium	Swivelling Angle	60 Degree
Colour Temperature	3000 K	Colour Rendering Index (Ra)	80
Rated Input Voltage	220-240 V/AC	Primary Cable Length	1 m
Power Supply Unit incl.	Yes	Primary Connection End	Connection box
Installation Depth	220 mm	Light Distribution	Symmetric

Article	Housing Color	Luminous Flux	Ø cut out	Height	Ø	Power	Light Beam Angle	Price
730267	Silver	480 lm	155 mm	128 mm	173 mm	9.3 W	17 Degree	€ 349.95
730266	Silver	770 lm	222 mm	190 mm	250 mm	18.4 W	25 Degree	€ 599.95

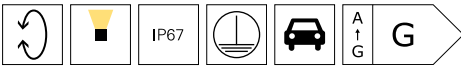



SQUARE BEAM

·Including 0.5 m connecting cable

Housing	Stainless steel, Aluminium	Installation Depth	95 mm
Colour Temperature	3000 K	Light Beam Angle	25 Degree
Luminous Flux	700 lm	Cut Out Length	112 mm
Length	125 mm	Cut Out Width	112 mm
Width	125 mm	Colour Rendering Index (Ra)	80
Height	75 mm	Primary Cable Length	0.5 m
Power	7.7 W	Primary Connection End	Connection box
Rated Input Voltage	220-240 V/AC	Light Distribution	Symmetric
Power Supply Unit incl.	Yes		

Article Housing Color Price

730209 Silver **€ 169.95**



SQUARE SOFT

Housing	Stainless steel, Aluminium	Installation Depth	95 mm
Colour Temperature	3000 K	Light Beam Angle	120 Degree
Luminous Flux	160 lm	Cut Out Length	113.5 mm
Length	125 mm	Cut Out Width	113.5 mm
Width	125 mm	Colour Rendering Index (Ra)	80
Height	75 mm	Primary Cable Length	0.5 m
Power	3.2 W	Primary Connection End	Connection box
Rated Input Voltage	220-240 V/AC	Light Distribution	Symmetric
Power Supply Unit incl.	Yes		

Article Housing Color Price

730248 Silver **€ 179.95**





EASY SQUARE

•Including 0.5 m connecting cable with WEIPU plug

Housing	Stainless steel, Aluminium	Installation Depth	133 mm
Luminous Flux	80 lm	Light Beam Angle	30 Degree
Length	55 mm	Cut Out Ø	49 mm
Width	55 mm	Control	Dimmable via optional controller
Height	101 mm	Primary Cable Length	0.5 m
Power	3.5 W	Primary Connection End	WEIPU plug 4-pole
Rated Input Voltage	24 V/DC	IK Protection Class	IK08
Power Supply Unit incl.	No	Light Distribution	Symmetric

Article	Housing Color	Price
730244	<input type="checkbox"/> Silver 	€ 179.95

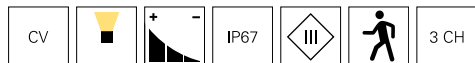

Accessories

872083 IP, CV, V6-40-24



€ 74.95

843502 RF-smart, Starter-Set RGB/W/CCT, 12-48V, 20A remote control, IP20 incl.



€ 99.95



Lighting design

Interested in our lighting design service?

Your contact person will be happy to answer any questions you may have.



HELIOS

·Including 4 heavy-duty brackets

Housing	Aluminium	Rated Input Voltage	220-240 V/AC
Colour Temperature	3000 K	Power Supply Unit incl.	Yes
Height	54 mm	Light Beam Angle	60 Degree
Ø	210 mm	Colour Rendering Index (Ra)	80
Base Height	7 mm	IK Protection Class	IK10
Base Ø	198 mm		

Article	Housing Color		Luminous Flux	Number of light outlets	Power	EEL	Price
732143	■ Grey	ww	34 lm	1	2.5 W		€ 119.95
732049	■ Grey	ww	65 lm	2	3.8 W	⊞ G	€ 119.95
732050	■ Grey	ww	150 lm	4	5.5 W	⊞ G	€ 119.95

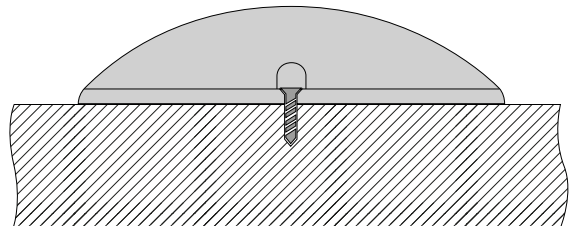
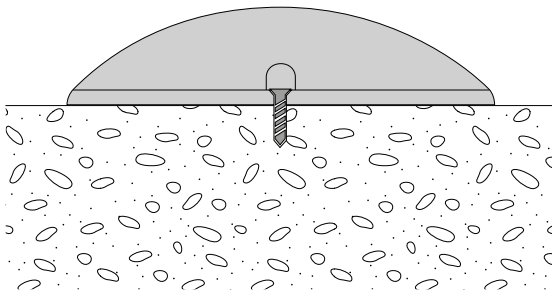



LINE

•Including connecting cable

Housing	Stainless steel, Aluminium	Light Beam Angle	20 Degree
Colour Temperature	3000 K	Cut Out Width	68 mm
Width	68 mm	Colour Rendering Index (Ra)	80
Height	31.5 mm	Primary Cable Length	0.5 m
Rated Input Voltage	220-240 V/AC	Primary Connection End	Connection box
Power Supply Unit incl.	Yes	IK Protection Class	IK07
Installation Depth	80 mm	Light Distribution	Symmetric

Article	Housing Color		Luminous Flux	Length	Power	Cut Out Length	Price
730434	Silver		1100 lm	549 mm	18.0 W	527 mm	€ 379.95
730432	Silver		2300 lm	1025 mm	36.0 W	1007 mm	€ 599.95



LINE ASYMMETRICAL

Housing	Stainless steel, Aluminium	Light Beam Angle	45 Degree
Colour Temperature	3000 K	Light Beam Angle 2	35 Degree
Width	63 mm	Cut Out Width	58 mm
Height	65 mm	Colour Rendering Index (Ra)	80
Rated Input Voltage	220-240 V/AC	Primary Connection End	Connection box
Power Supply Unit incl.	Yes	Light Distribution	Asymetric
Installation Depth	90 mm		

Article	Housing Color		Luminous Flux	Length	Power	Cut Out Length	Primary Cable Length	Price
730292	Silver		340 lm	195 mm	5.5 W	180 mm	0.5 m	€ 179.95
730262	Silver		730 lm	328 mm	11.9 W	313 mm	1 m	€ 249.95





With the kind support of Licht von Klein / licht-von-klein.de



TABIT

The recessed floor lights in the TABIT series impress with their square and rectangular shape and an output of up to 3.7 W at 3000 K. The paving stone look of the lights makes them compatible with standard paving dimensions. Each light is supplied with a 30 cm long connection cable with open cable ends. They can be walked on, but not driven on, and can withstand a load of 5,000 N.





TABIT

- Paving stone look
- Suitable for common paving dimensions
- Incl. 30 cm connection line with open cable ends
- Can be walked on, cannot be driven on
- 5,000 N load

Housing	Polycarbonate	Light Beam Angle	120 Degree
Surface	Transparent	Colour Rendering Index (Ra)	80
Colour Temperature	3000 K	Primary Cable Length	0.3 m
Height	68 mm	Primary Connection End	With free strand / conductor ends
Rated Input Voltage	220-240 V/AC	IK Protection Class	IK10
Power Supply Unit incl.	Yes		
Installation Depth	68 mm		

Article	Housing Color		Luminous Flux	Length	Width	Power	Price
730480	Grey	ww	120 lm	100 mm	100 mm	2.3 W	€ 29.95
730481	Grey	ww	240 lm	200 mm	100 mm	3.7 W	€ 59.95
730482	Grey	ww	240 lm	200 mm	200 mm	3.7 W	€ 99.95

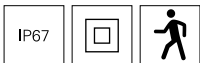

Accessories

Cables, plugs, clamps and more:
You can find the right mounting accessories in the »Accessories« section.



floodlight



■
page 518



■ ■
page 519



■
page 520



■
page 521





DEKO-LIGHT RF-SMART FLOODLIGHT RGB+CCT RF + ZIGBEE

- Brightness and colour saturation can be adjusted
- 16 million available colours and adjustable colour temperature
- 18 automatic programmes pre-installed
- Programme and remote control synchronisation when operating multiple RF-smart components (repeater function)
- Can be controlled with RF-smart wireless remote controls (2.4 GHz, range approx. 30 m, not included in the scope of delivery)
- Can be controlled with all Zigbee 3.0 compatible controllers/apps such as Amazon Echo (Alexa), Google Assistant, Tuya (relevant gateway required, outdoor range up to 100 m)

Housing	Aluminium, Plastic	Control	RF-Smart, ZigBee
Colour Temperature	2700-6500 K		3.0
Rated Input Voltage	100-240 V/AC	Primary Cable Length	1.5 m
Power Supply Unit incl.	Yes	Colour Rendering Index (Ra)	80
Light Beam Angle	160 Degree	Light Direction	Front
Swivelling Angle	345 Degree	IP Protection Type Plug	IP 44

Article	Housing Color		Luminous Flux	Length	Width	Height	Power	Price
843518	■ Anthracite		3300 lm	167 mm	40 mm	227 mm	30.0 W	€ 249.95
843519	■ Anthracite		4800 lm	220 mm	48 mm	311 mm	50.0 W	€ 349.95
843520	■ Anthracite		10000 lm	295 mm	60 mm	403 mm	100.0 W	€ 549.95



Accessories

843510	RF-smart, remote control, white, 1 zone, RGB/RGBW/RGB+CCT, IP20		€ 38.95
843511	RF-smart, remote control, black, 1 zone, RGB/RGBW/RGB+CCT, IP20		€ 38.95
843512	RF-smart, remote control, black, 8 zones, Single/CCT/RGB/RGBW/RGB+CCT		€ 49.95
843513	RF-smart, wall remote control, white, 3V, 4 zones, Single/CCT/RGB/W/+CCT		€ 69.95
843522	RF-smart, wall remote control, white, 230V, 4 zones, Single/CCT/RGB/W/+CCT		€ 74.95
843514	RF-smart, wall remote control, white, 8 zones, Single/CCT/RGB/RGBW/RGB+CCT		€ 109.95
930659	Wall bracket/display arm, metal, black, 800 mm		€ 59.95



FLOOD SMD

- Including 1.2 m connecting cable with IP44 shaped plug
- Housing made of durable die-cast aluminium and glass

Housing	Aluminium	Primary Connection End	Power plug IP44
Rated Input Voltage	220-240 V/AC	Colour Rendering Index (Ra)	80
Power Supply Unit incl.	Yes	IP Protection Type Plug	IP 44
Light Beam Angle	100 Degree	IK Protection Class	IK08
Primary Cable Length	1.2 m		

Article	Housing Color	Colour Temp.	Luminous Flux	Length	Width	Height	power	EEL	Price
732147	Silver	3000 K	1800 lm	179 mm	143.6 mm	27 mm	15 W		€ 89.95
732148	Black	3000 K	1800 lm	179 mm	143.6 mm	27 mm	15 W		€ 89.95
732150	Silver	3000 K	3600 lm	237 mm	250 mm	40.5 mm	30 W		€ 129.95
732151	Black	3000 K	3600 lm	237 mm	250 mm	40.5 mm	30 W		€ 129.95
732149	Silver	4000 K	1950 lm	179 mm	143.6 mm	27 mm	15 W		€ 89.95
732152	Silver	4000 K	3900 lm	237 mm	250 mm	40.5 mm	30 W		€ 129.95



page 351

page 351



Technical data sheet

New in the onlineshop: The technical data sheets offer even more information: Light and energy data, light distribution curves, dimensional drawings and more.



BRACHIUM

·incl. 2 m connecting cable with IP44 plug

Housing	Aluminium	Power Supply Unit incl.	Yes
Length	316 mm	Light Beam Angle	75 Degree
Width	286 mm	Swivelling Angle	180 Degree
Height	41 mm	Primary Cable Length	2 m
Base Length	327 mm	Primary Connection End	Power plug IP44
Base Width	28 mm	Colour Rendering Index (Ra)	80
Base Height	160 mm	IP Protection Type Plug	IP 44
Power	82 W	IK Protection Class	IK08
Rated Input Voltage	220-240 V/AC		

Article	Housing Color	Colour Temperature	Luminous Flux	Price
732064	■ Black	ww 3000 K	8100 lm	€ 199.95
732105	■ Black	nw 4000 K	8400 lm	€ 199.95

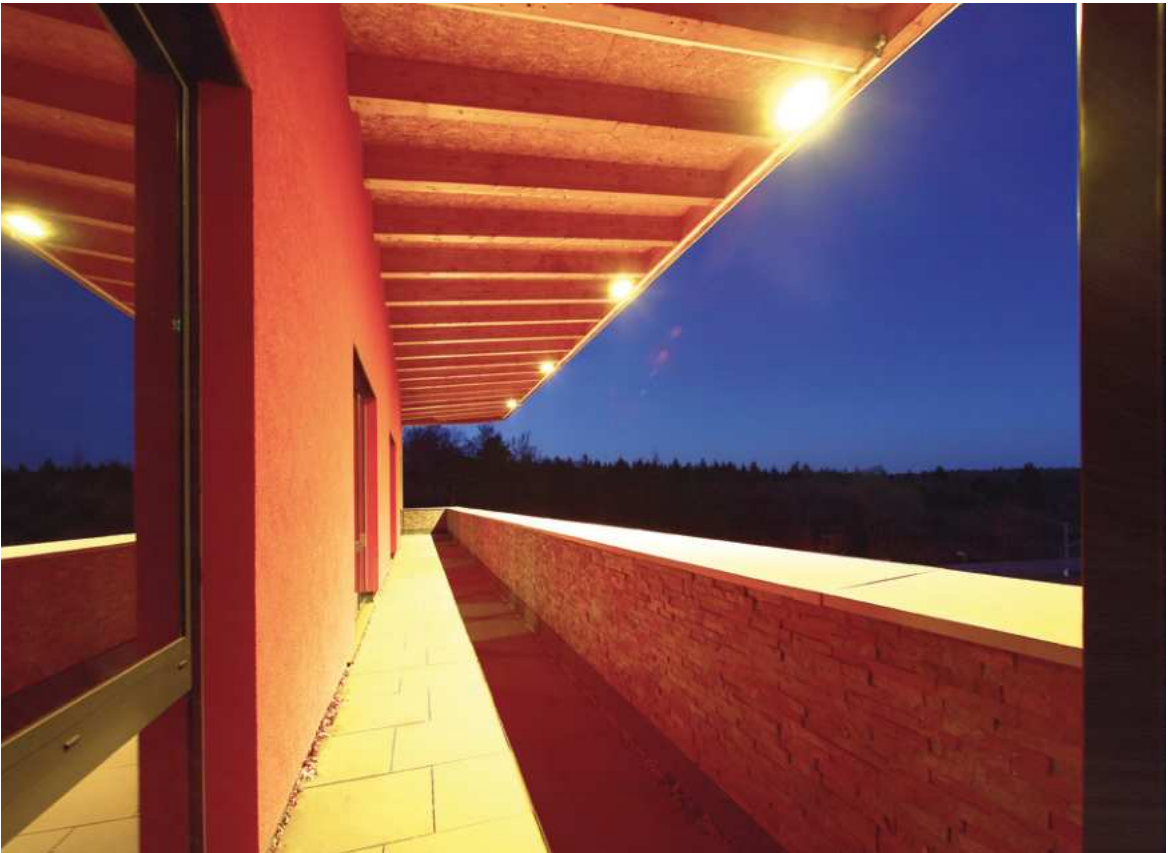
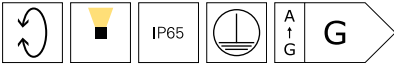



ATIK

- IEC62662 - Protection against mechanical effects (IK Code)
- EN60598-2-24 - Lights for use in explosive gas and dust atmosphere (D designation)
- Including 2 m connecting cable with IP44 plug

Housing	Aluminium	Swivelling Angle	180 Degree
Colour Temperature	4000 K	Primary Cable Length	2 m
Length	319 mm	Primary Connection End	Power plug IP44
Width	90 mm	Colour Rendering Index (Ra)	80
Height	411 mm	IP Protection Type Plug	IP 44
Power Supply Unit incl.	Yes	IK Protection Class	IK08
Light Beam Angle	110 Degree		

Article	Housing Color		Luminous Flux	Power	Rated Input Voltage	EEL	Price
732096	Black	NW	21350 lm	152.0 W	220-240 V/AC	D	€ 419.95
732097	Black	NW	28450 lm	202.0 W	220-240 V/AC	D	€ 529.95
732098	Black	NW	31800 lm	242.0 W	220-240 V/AC	D	€ 599.95
732102	Black	NW	39900 lm	302.0 W	100-240 V/AC	E	€ 699.95



Onlineshop

You can find more information about the products in the onlineshop: Detailed images, videos, project reports, LDT files, EPREL data sheets and more.



page 524

display lights







ATIS

When it comes to illuminating signs, façades, billboards or images, display lights are the perfect choice. They are easy to install, exceptionally efficient and suit almost any environment thanks to their timeless design. With the suitable IP protection, they can also be used outdoors, where they can be used as additional sources of lighting.



ATIS

·Rotatable and swivelling lamp head

Housing	Aluminium	Rated Input Voltage	220-240 V/AC
Colour Temperature	3000 K	Power Supply Unit incl.	Yes
Luminous Flux	1150 lm	Light Beam Angle	100 Degree
Length	526 mm	Swivelling Angle	90 Degree
Width	144 mm	Control	Leading-edge dimmer, Trailing-edge dimmer
Base Length	95 mm	Colour Rendering Index (Ra)	80
Base Height	40 mm		
Power	15 W		

Article	Housing Color		Price
688020	<input type="checkbox"/> White		€ 219.95
688021	<input checked="" type="checkbox"/> Black		€ 219.95



Technical data sheet

New in the onlineshop: The technical data sheets offer even more information: Light and energy data, light distribution curves, dimensional drawings and more.



SYSTEM PLANO

528 PLANO luminaire system

546 PLANO-profiles



PLANO luminaire system



PLANO DS
luminaire system
page 532



PLANO ES
luminaire system
page 534



PLANO ES RECESSED
luminaire system
page 538



PLANO MS
luminaire system
page 540



PLANO MS RECESSED
luminaire system
page 542

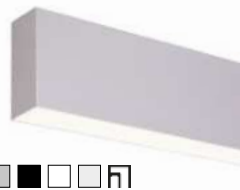

PLANO BSH
luminaire system
page 544



PLANO LUMINAIRE SYSTEM

Whether as a recessed version, surface-mounted ceiling luminaire or pendant luminaire as well as for wall mounting: the PLANO series is more than just another combination of profile and LED strip and is produced entirely in Europe.

The linear lighting solutions are based on four different profiles and can be configured individually. Thus, there are hardly any limits to the possible applications - whether in the office, in schools, in private living areas, in stores, showrooms and many more.



INDIVIDUAL SOLUTION

A PLANO profile luminaire always has the same design - and yet it is individual. Inside sits a profile with LED illumination in 2,700, 3,000 or 4,000 K. The surrounding luminaire body is made of extruded aluminum and has an anodized or powder-coated surface.

You can individually determine the length, equipment as well as the basic shape of the body, because the PLANO series is an individual lighting solution.

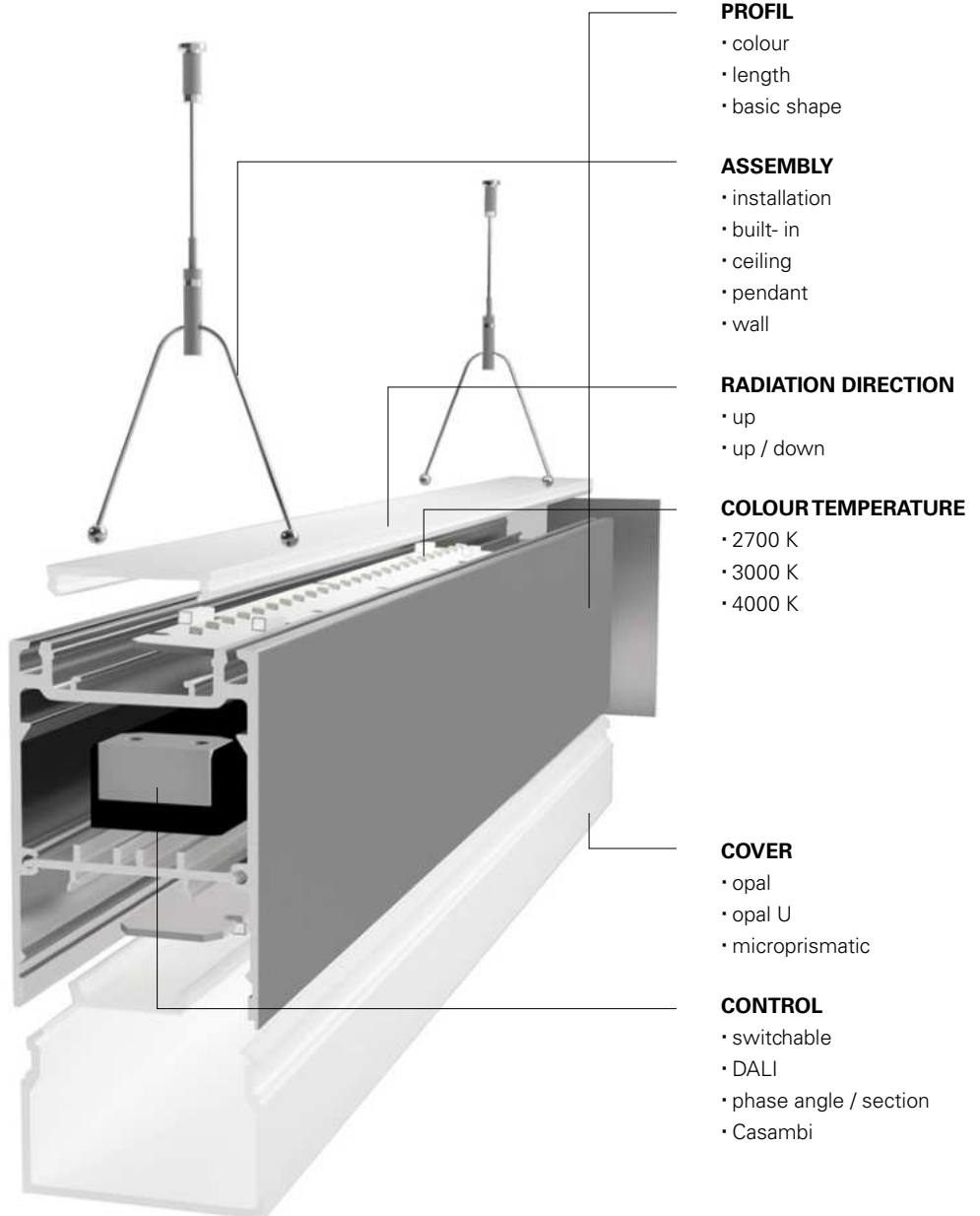

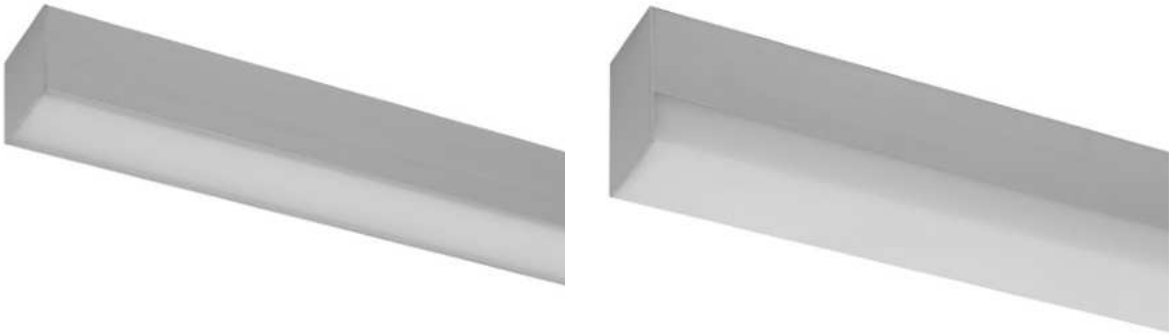

PLANO DS LUMINAIRE SYSTEM

- aluminium die casting
- direct light

assembly				cover			length	radiation dir.		colour	colour temperature			control			
ceiling structure	pendulum	wall structure	ceiling mounting	opal	opal U	microprismatic	individual	down	up+down	individual	2700 K	3000 K	4000 K	switchable	DALI	phase angle/section	Casambi
x	x			x	x	x	x	x		x	x	x	x	x	x	x	x

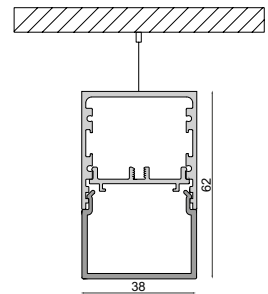
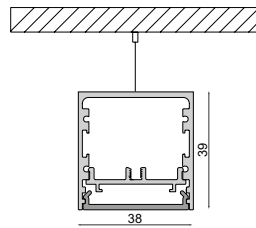
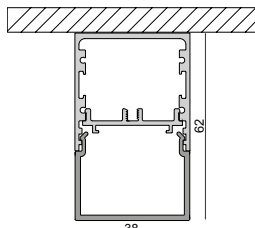
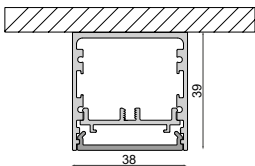
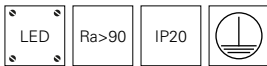

CONFIGURATION EXAMPLE

- DS surface-mounted luminaire | 2400 mm | black
- 74 W
- 3000 K | 6827 lm
- EVG | DALI
- incl. U-cover opal
- incl. end caps

price on demand

Of course, you can configure our PLANO system entirely according to your wishes and circumstances.

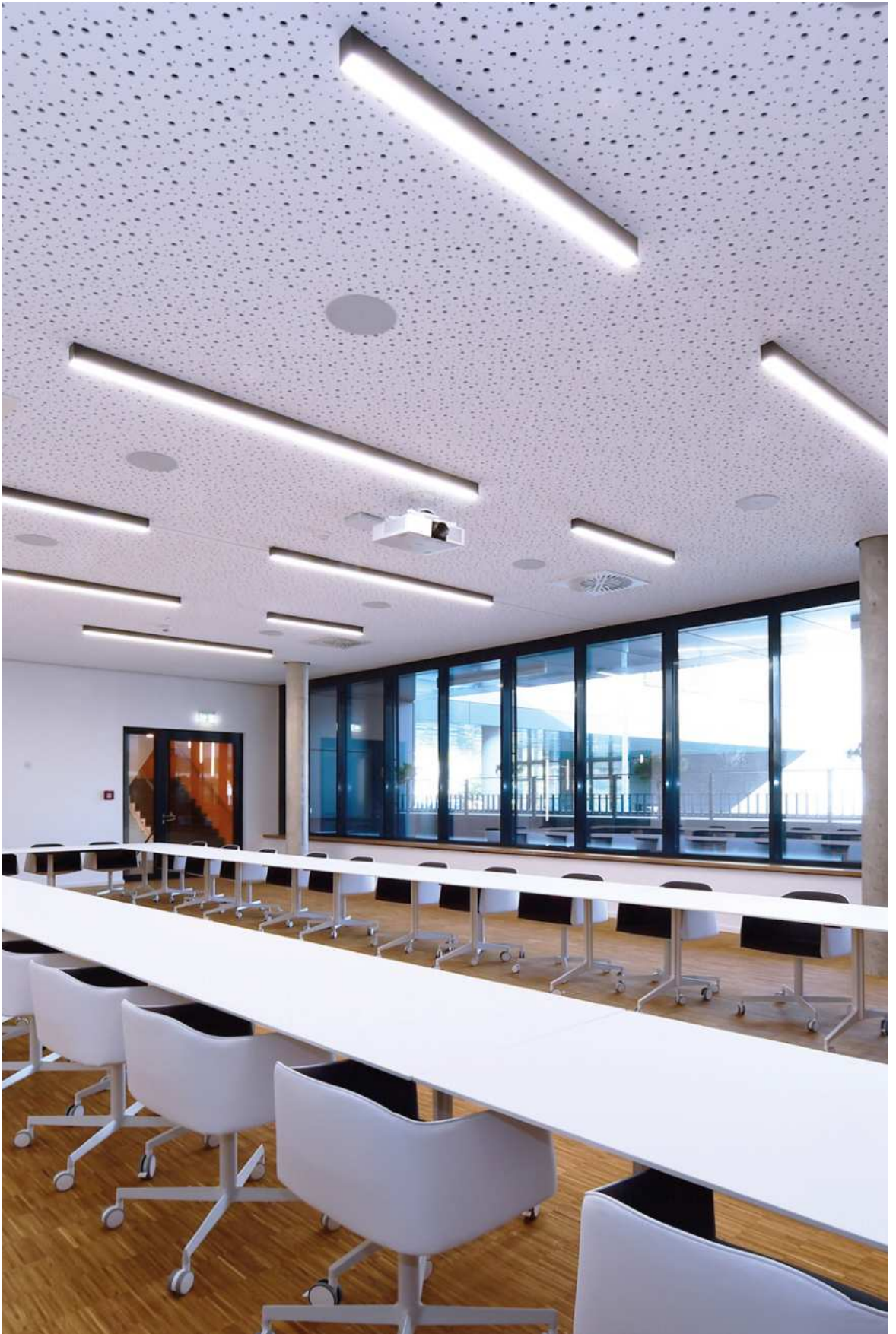

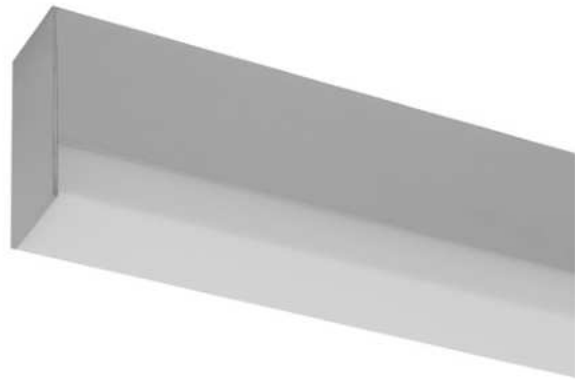
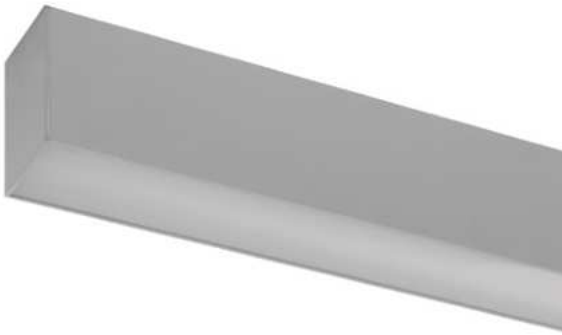

PLANO ES LUMINAIRE SYSTEM

- aluminium die casting
- direct light

assembly				cover			length	radiation dir.		colour	colour temperature			control			
ceiling structure	pendulum	wall structure	ceiling mounting	opal	opal U	microprismatic	individual	down	up+down	individual	2700 K	3000 K	4000 K	switchable	DALI	phase angle/section	Casambi
X	X			X	X	X	X	X	X	X	X	X	X	X	X	X	X

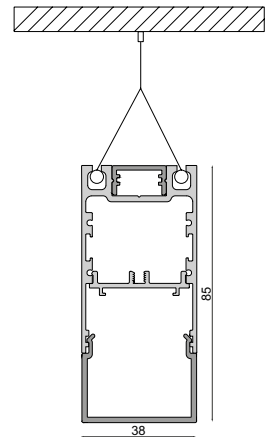
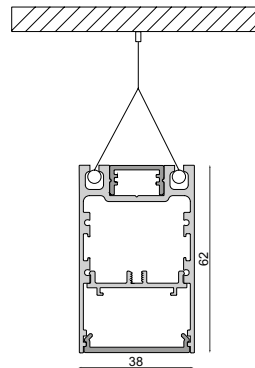
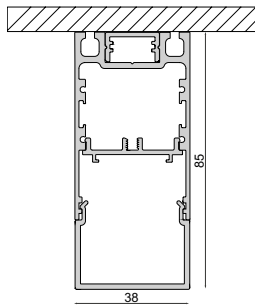
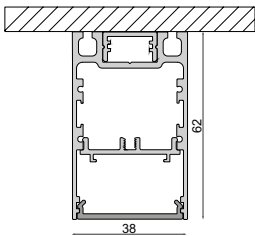
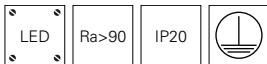

CONFIGURATION EXAMPLE

- ES surface-mounted luminaire | 2400 mm | black
- 74 W
- 3000 K | 5425 lm
- EVG | DALI
- incl. U-cover flat opal
- incl. end caps

price on demand

Of course, you can configure our PLANO system entirely according to your wishes and circumstances.



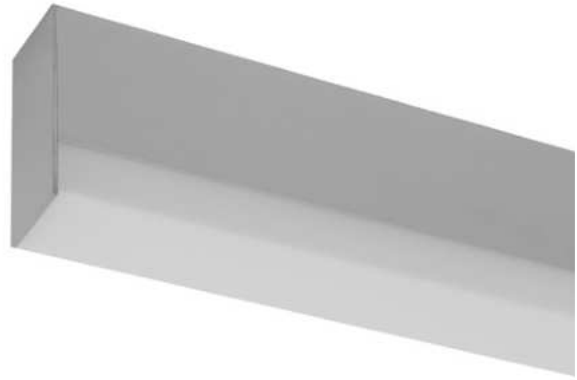
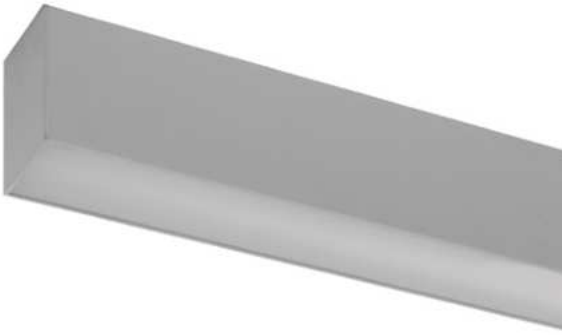

PLANO ES LUMINAIRE SYSTEM

- aluminium die casting
- direct light

assembly				cover			length	radiation dir.		colour	colour temperature			control			
ceiling structure	pendulum	wall structure	ceiling mounting	opal	opal U	microprismatic	individual	down	up+down	individual	2700 K	3000 K	4000 K	switchable	DALI	phase angle/section	Casambi
		x		x	x	x	x	x	x	x	x	x	x	x	x	x	x

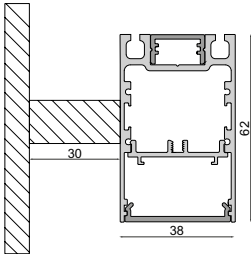
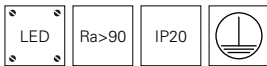

CONFIGURATION EXAMPLE

- ES wall-mounted luminaire | 2400 mm | black
- 97 W
- 3000 K | 7201 lm
- EVG | DALI
- incl. U-cover flat opal
- incl. end caps and wall bracket

price on demand

Of course, you can configure our PLANO system entirely according to your wishes and circumstances.

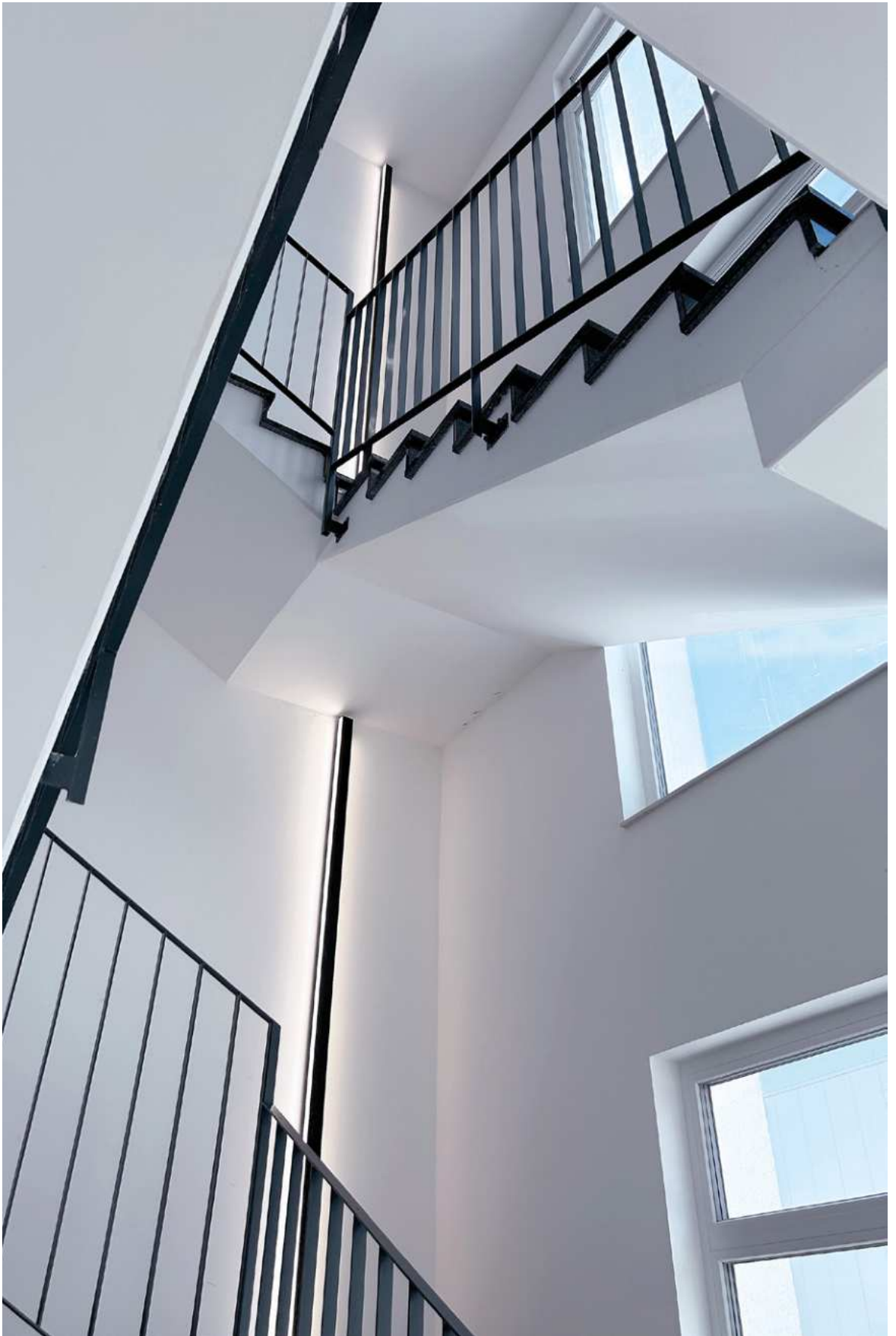

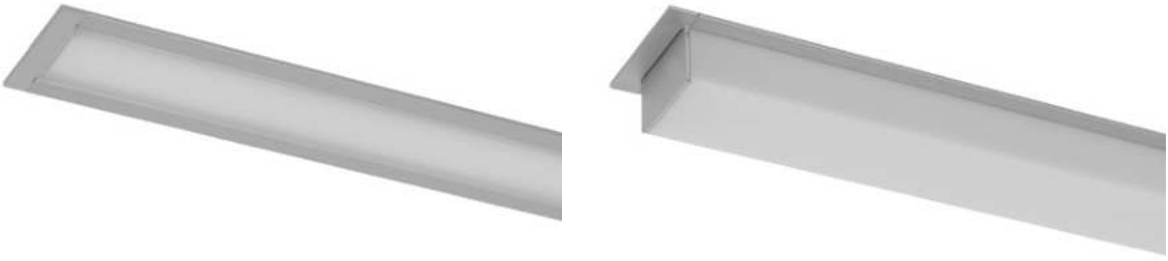

PLANO ES RECESSED LUMINAIRE SYSTEM

- aluminium die casting
- direct light

assembly				cover			length	radiation dir.		colour	colour temperature			control			
ceiling structure	pendulum	wall structure	ceiling mounting	opal	opal U	microprismatic	individual	down	up+down	individual	2700 K	3000 K	4000 K	switchable	DALI	phase angle/section	Casambi
			x	x	x	x	x	x		x	x	x	x	x	x	x	x

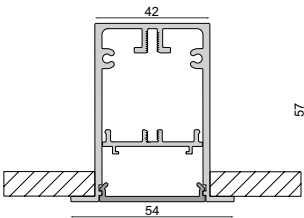

CONFIGURATION EXAMPLE

- ES recessed ceiling luminaire | 2400 mm | black
- 97 W
- 3000 K | 7201 lm
- EVG | DALI
- incl. U-cover flat opal
- incl. end caps and mounting bracket

price on demand

Of course, you can configure our PLANO system entirely according to your wishes and circumstances.



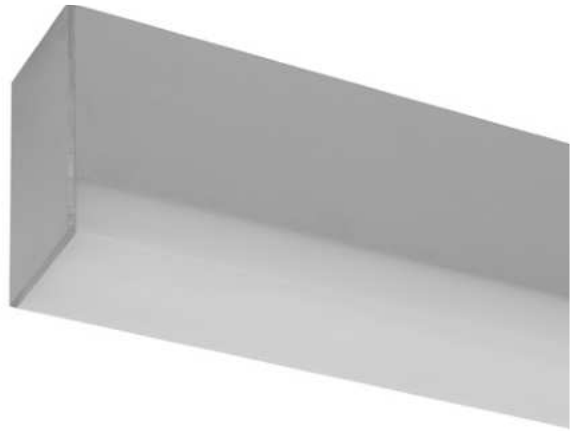
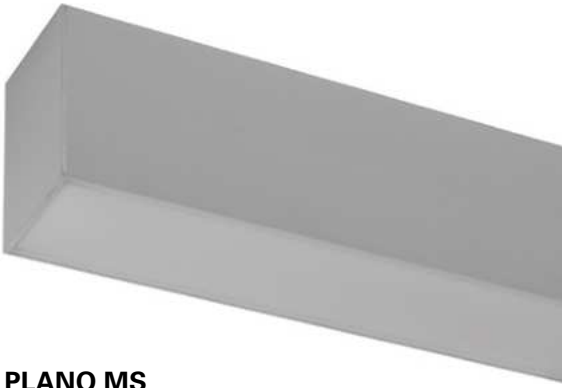

PLANO MS LUMINAIRE SYSTEM

- aluminium die casting
- direct light

assembly				cover			length	radiation dir.		colour	colour temperature			control			
ceiling structure	pendulum	wall structure	ceiling mounting	opal	opal U	microprismatic	individual	down	up+down	individual	2700 K	3000 K	4000 K	switchable	DALI	phase angle/section	Casambi
x	x			x	x	x	x	x	x	x	x	x	x	x	x	x	x

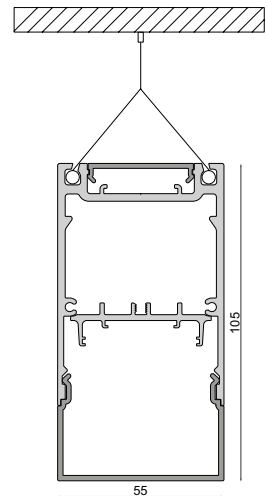
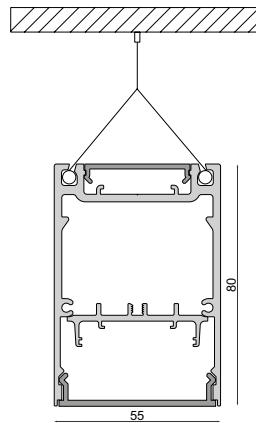
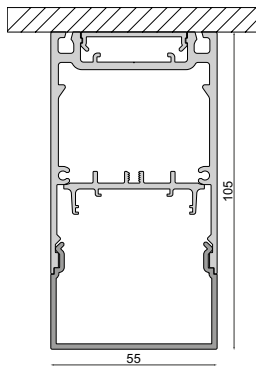
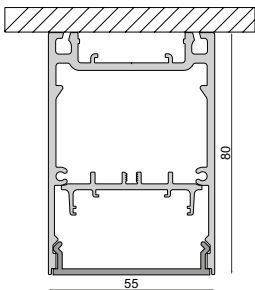
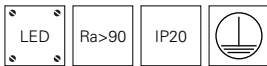

CONFIGURATION EXAMPLE

- MS surface-mounted luminaire | 2400 mm | black
- 74 W
- 3000 K | 6990 lm
- EVG | DALI
- incl. U-cover opal
- incl. end caps

price on demand

Of course, you can configure our PLANO system entirely according to your wishes and circumstances.





PLANO MS RECESSED LUMINAIRE SYSTEM

- aluminium die casting
- direct light

assembly				cover			length	radiation dir.		colour	colour temperature			control			
ceiling structure	pendulum	wall structure	ceiling mounting	opal	opal U	microprismatic	individual	down	up+down	individual	2700 K	3000 K	4000 K	switchable	DALI	phase angle/section	Casambi
			x	x	x	x	x	x		x	x	x	x	x	x	x	x

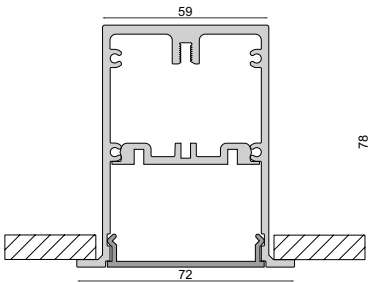

CONFIGURATION EXAMPLE

- MS recessed ceiling luminaire | 2400 mm | black
- 74 W
- 3000 K | 6990 lm
- EVG | DALI
- incl. U-cover opal
- incl. end caps and mounting bracket

price on demand

Of course, you can configure our PLANO system entirely according to your wishes and circumstances.





PLANO BSH LUMINAIRE SYSTEM

- aluminium die casting
- direct light

assembly				cover			length	radiation dir.		colour	colour temperature			control			
ceiling structure	pendulum	wall structure	ceiling mounting	opal	opal U	microprismatic	individual	down	up+down	individual	2700 K	3000 K	4000 K	switchable	DALI	phase angle/section	Casambi
		x		x	x	x	x	x	x	x	x	x	x	x	x	x	x

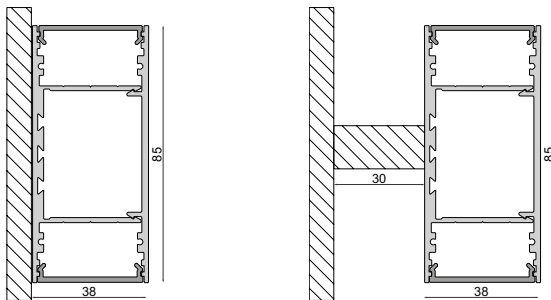
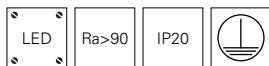

CONFIGURATION EXAMPLE

- BSH wall-mounted luminaire | 2400 mm | black
- 174 W,
- 3000 K | 10822 lm
- EVG | DALI
- incl. U-cover opal
- incl. end caps

price on demand

Of course, you can configure our PLANO system entirely according to your wishes and circumstances.





□ ■
page 548



□ ■
page 550

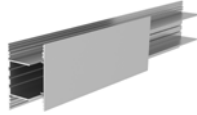

□ ■
page 552

PLANO profiles





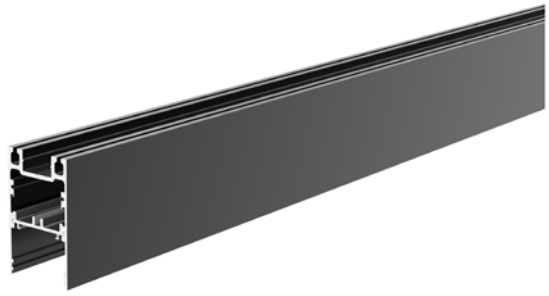
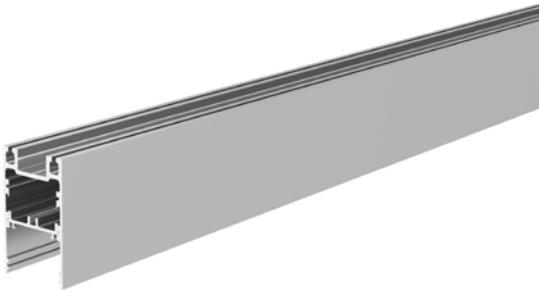

PROFILE PLANO ES

- universal light profile
- Uplight for LED strips up to 15 mm wide
- Downlight for LED strips up to 22 mm wide
- incl. LED carrier

Housing Aluminium

Article	Housing Color	Surface	Length	Price
970574	Black		2000 mm	€ 129.95
970575	Black		2500 mm	€ 159.95
970572	Aluminium	Anodised	2000 mm	€ 129.95
970573	Aluminium	Anodised	2500 mm	€ 159.95

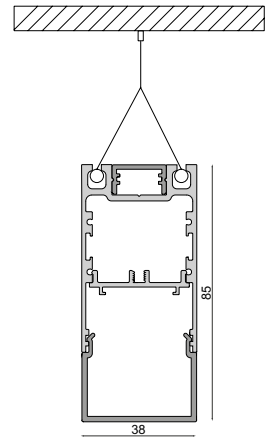
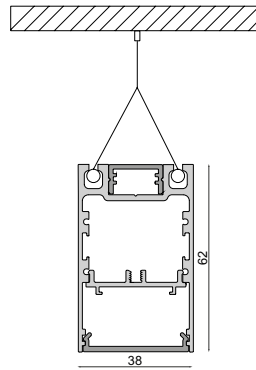
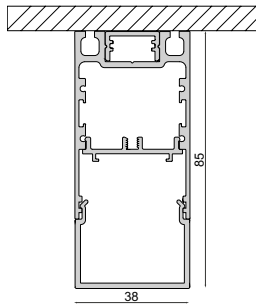
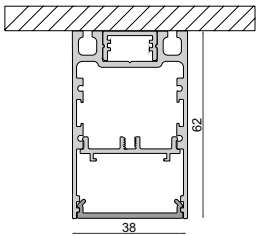

Accessories

988201	PLANO ES straight connector	€ 9.95
988204	PLANO ES Corner connector	€ 18.95
988206	PLANO Wall bracket, aluminium	€ 49.95
988095	PLANO ES & MS Rope suspension set, in pairs	€ 89.95
840192	Power, SMD, 24 V-20 W, 2,700 K, 5 m	€ 164.95
840193	Power, SMD, 24 V-20 W, 3,000 K, 5 m	€ 164.95
840194	Power, SMD, 24 V-20 W, 4,000 K, 5 m	€ 164.95
862124	LONG-FLAT, CV, LT-45-24	€ 49.95
862094	LONG-FLAT, CV, LT-60-24	€ 59.95
862126	LONG-FLAT, CV, LT-100-24	€ 96.95
862173	LONG-FLAT, CV, LT-150-24	€ 129.95
Accessories for 970572, 970573		
988092	PLANO ES End cap surface-mounted anodized aluminium	€ 24.95
988207	PLANO ES & MS Uplight Blind Cover, anodized aluminium	€ 29.95
Accessories for 970572, 970574		
988086	PLANO ES & BSH & MS Uplight Cover flat opal, 2m	€ 39.95
988088	PLANO ES & BSH Cover high opal, 2m	€ 84.95
988090	PLANO ES & BSH & MS Uplight Cover flat microprism, 2m	€ 69.95
988111	PLANO ES cover inside opal, 2m	€ 24.95
Accessories for 970573, 970575		
988087	PLANO ES & BSH & MS Uplight Cover flat opal, 2,5m	€ 49.95
988089	PLANO ES & BSH Cover high opal, 2,5m	€ 104.95
988091	PLANO ES & BSH & MS Uplight Cover flat microprism, 2,5m	€ 84.95
988112	PLANO ES cover inside opal, 2.5m	€ 29.95
Accessories for 970574, 970575		
988093	PLANO ES End cap surface-mounted black	€ 24.95
988208	PLANO ES & MS Uplight Blind Cover, black	€ 49.95

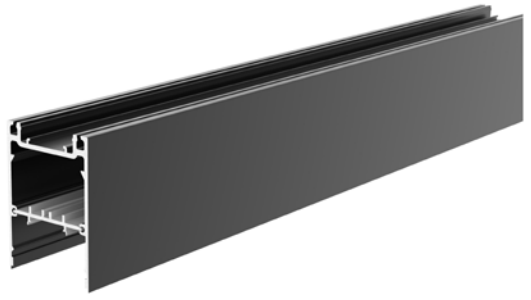
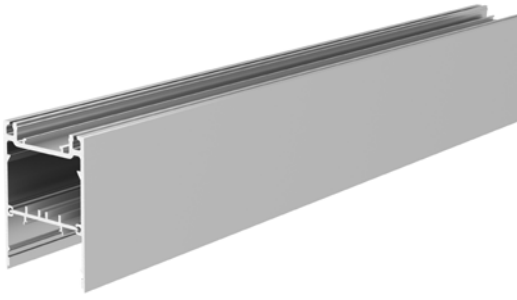

PROFILE PLANO MS

- universal light profile
- Uplight for LED strips up to 24 mm wide
- Downlight for LED strips up to 24 mm wide
- incl. LED carrier

Housing Aluminium

Article	Housing Color	Surface	Length	Price
970580	Black		2000 mm	€ 274.95
970581	Black		2500 mm	€ 339.95
970578	Aluminium	Anodised	2000 mm	€ 274.95
970579	Aluminium	Anodised	2500 mm	€ 339.95

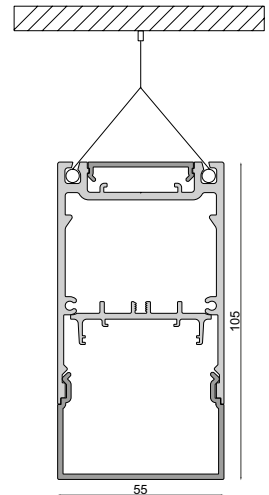
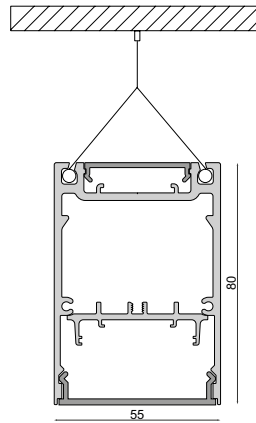
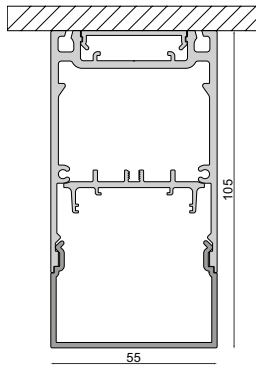
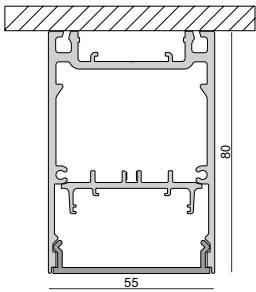

Accessories

988200	PLANO MS straight connector	€ 9.95
988203	PLANO MS Corner connector	€ 18.95
988206	PLANO Wall bracket, aluminium	€ 49.95
840192	Power, SMD, 24 V-20 W, 2,700 K, 5 m	€ 164.95
840193	Power, SMD, 24 V-20 W, 3,000 K, 5 m	€ 164.95
840194	Power, SMD, 24 V-20 W, 4,000 K, 5 m	€ 164.95
862124	LONG-FLAT, CV, LT-45-24	€ 49.95
862094	LONG-FLAT, CV, LT-60-24	€ 59.95
862126	LONG-FLAT, CV, LT-100-24	€ 96.95
862173	LONG-FLAT, CV, LT-150-24	€ 129.95
862265	LONG-FLAT, CV, LT-240-24	€ 159.95
Accessories for 970578, 970579		
988102	PLANO MS End cap surface-mounted anodized aluminium	€ 24.95
988207	PLANO ES & MS Uplight Blind Cover, anodized aluminium	€ 29.95
988210	PLANO MS Downlight Blind Cover, anodized aluminium	€ 44.95
Accessories for 970578, 970580		
988086	PLANO ES & BSH & MS Uplight Cover flat opal, 2m	€ 39.95
988090	PLANO ES & BSH & MS Uplight Cover flat microprism, 2m	€ 69.95
988096	PLANO MS Downlight Cover flat opal, 2m	€ 49.95
988098	PLANO MS Downlight Cover high opal, 2m	€ 99.95
988100	PLANO MS Downlight Cover flat microprism, 2m	€ 69.95
Accessories for 970579, 970581		
988087	PLANO ES & BSH & MS Uplight Cover flat opal, 2,5m	€ 49.95
988091	PLANO ES & BSH & MS Uplight Cover flat microprism, 2,5m	€ 84.95
988097	PLANO MS Downlight Cover flat opal, 2,5m	€ 64.95
988099	PLANO MS Downlight Cover high opal, 2,5m	€ 124.95
988101	PLANO MS Downlight Cover flat microprism, 2,5m	€ 84.95
Accessories for 970580, 970581		
988103	PLANO MS End cap surface-mounted black	€ 29.95
988208	PLANO ES & MS Uplight Blind Cover, black	€ 49.95
988211	PLANO MS Downlight Blind Cover, black	€ 69.95

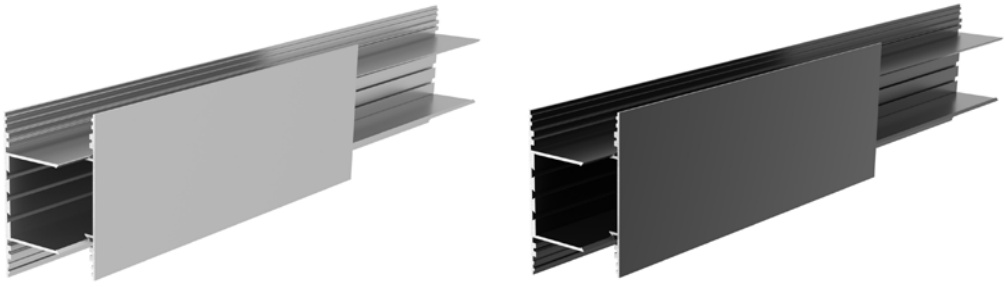

PROFILE PLANO BSH

- universal light profile
- Uplight for LED strips up to 31 mm wide
- Downlight for LED strips up to 31 mm wide
- incl. LED carrier

Housing Aluminium

Article	Housing Color	Surface	Length	Price
970586	Black		2000 mm	€ 199.95
970587	Black		2500 mm	€ 249.95
970584	Aluminium	Anodised	2000 mm	€ 139.95
970585	Aluminium	Anodised	2500 mm	€ 169.95

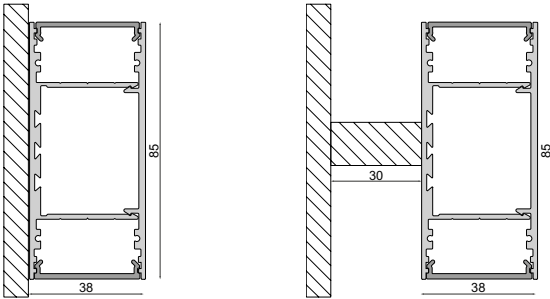

Accessories

988202	PLANO BSH straight connector	€ 9.95
988205	PLANO BSH Corner connector	€ 18.95
988206	PLANO Wall bracket, aluminium	€ 49.95
988095	PLANO ES & MS Rope suspension set, in pairs	€ 89.95
840192	Power, SMD, 24 V-20 W, 2,700 K, 5 m	€ 164.95
840193	Power, SMD, 24 V-20 W, 3,000 K, 5 m	€ 164.95
840194	Power, SMD, 24 V-20 W, 4,000 K, 5 m	€ 164.95
862124	LONG-FLAT, CV, LT-45-24	€ 49.95
862094	LONG-FLAT, CV, LT-60-24	€ 59.95
862126	LONG-FLAT, CV, LT-100-24	€ 96.95
862173	LONG-FLAT, CV, LT-150-24	€ 129.95
Accessories for 970584, 970585		
988115	PLANO BSH End cap high surface-mounted anodized aluminium	€ 39.95
Accessories for 970584, 970586		
988086	PLANO ES & BSH & MS Uplight Cover flat opal, 2m	€ 39.95
988088	PLANO ES & BSH Cover high opal, 2m	€ 84.94
988090	PLANO ES & BSH & MS Uplight Cover flat microprism, 2m	€ 69.95
Accessories for 970585, 970587		
988087	PLANO ES & BSH & MS Uplight Cover flat opal, 2,5m	€ 49.95
988089	PLANO ES & BSH Cover high opal, 2,5m	€ 104.95
988091	PLANO ES & BSH & MS Uplight Cover flat microprism, 2,5m	€ 84.95
Accessories for 970586, 970587		
988116	PLANO BSH End cap high surface-mounted black	€ 39.95



SYSTEM COMBO

- 560 concrete profiles
- 564 Installation profiles
- 568 Insulation profiles
- 570 Click profiles

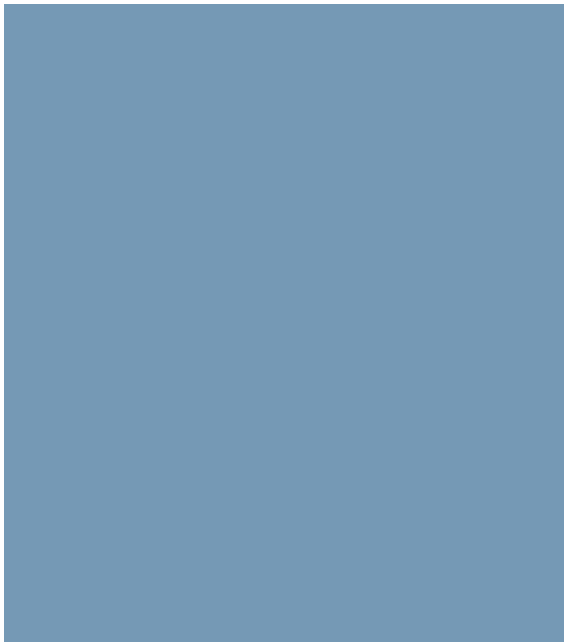

COMBO profiles

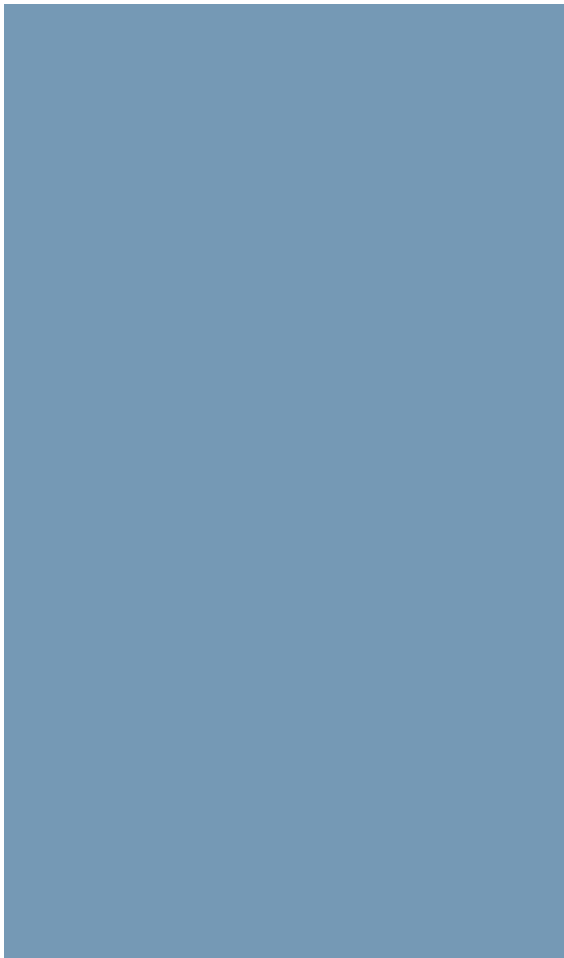

■ □
page 560



■ □
page 562



■ ■ □
page 564



■ ■ □
page 566



■ □
page 568



■ □
page 569



■ ■ □
page 570



■ ■ □
page 571



COMBO PROFILE SYSTEM

Easy to install profile-in-profile solution

Façades, gardens, living spaces: the patented COMBO profil system lends special character to any architecture. The linear system solution can be integrated into all standard building materials. The profile system not only draws perfect lines of light in exposed concrete, concrete, brick, stone, plasterboard, full thermal insulation, wood or façade panels, the COMBO CONCRETE, COMBO INSTALLATION

and COMBO INSULATION mounting profiles can also be installed quickly and cleanly by bricklayers, drywallers or façade builders. Just as important as the visual appearance is the fact that the lighting solutions can be easily integrated into the building structure, even under difficult installation conditions. The COMBO KLICK luminaire insert profile is simply clipped into the mounting profiles once the structure has been completed.







PROFILE, SERIES COMBO, CONCRETE, MOUNTING PROFILE

Housing Aluminium

Article	Housing Color	Length	Price
970800	Black	2000 mm	€ 114.95
970801	White	2000 mm	€ 114.95
970802	Black	3000 mm	€ 143.95
970803	White	3000 mm	€ 143.95

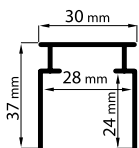















Lighting design

Interested in our lighting design service?

Your contact person will be happy to answer any questions you may have.

Accessories

988180	Combo stucco moulding - flush - polystyrene 24x29x1000		€ 8.95
988179	Combo stucco moulding - plaster edge - polystyrene 40x29x1000		€ 8.95
988167	Combo concrete mounting strip, in situ concrete, 1 m		€ 15.95
988168	Combo concrete mounting strip, in situ concrete, 2 m		€ 31.95
970811	Combo connection profile for indoor plastering, natural aluminium, 2.5 m		€ 78.95
970812	Combo connection profile for indoor plastering, white, 2.5 m		€ 114.95
970810	Combo connection profile for indoor plastering, black, 2.5 m		€ 114.95
970814	Combo installation connection profile for filling jobs, natural aluminium, 2 m		€ 13.95
970818	Combo installation connection profile for filling jobs, white, 2 m		€ 28.95
970816	Combo installation connection profile for filling jobs, black, 2 m		€ 28.95
988133	Combo concrete end cap mounting profile with edge covering, white		€ 2.95
988132	Combo concrete end cap mounting profile with edge covering, black		€ 2.95
988165	Combo concrete connecting piece mounting profile, white		€ 5.95
988164	Combo concrete connecting piece mounting profile, black		€ 5.95
988161	Combo concrete connector and fall protection for concrete recessed profile		€ 22.95

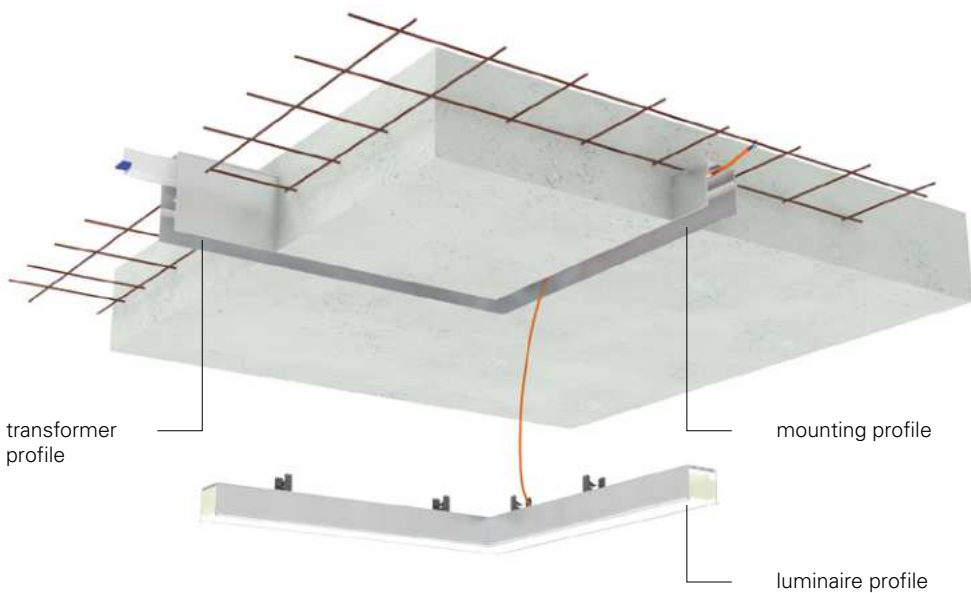



PROFILE, SERIES COMBO, CONCRETE, TRANSFORMER PROFILE







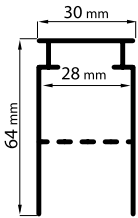







Housing

Aluminium

Article	Housing Color	Length	Price
970804	Black	1000 mm	€ 85.95
970805	White	1000 mm	€ 85.95
970806	Black	2000 mm	€ 172.95
970807	White	2000 mm	€ 172.95
970808	Black	3000 mm	€ 258.95
970809	White	3000 mm	€ 258.95



Accessories

988180	Combo stucco moulding - flush - polystyrene 24x29x1000		€ 8.95
988179	Combo stucco moulding - plaster edge - polystyrene 40x29x1000		€ 8.95
988167	Combo concrete mounting strip, in situ concrete, 1 m		€ 15.95
988168	Combo concrete mounting strip, in situ concrete, 2 m		€ 31.95
970811	Combo connection profile for indoor plastering, natural aluminium, 2.5 m		€ 78.95
970812	Combo connection profile for indoor plastering, white, 2.5 m		€ 114.95
970810	Combo connection profile for indoor plastering, black, 2.5 m		€ 114.95
970814	Combo installation connection profile for filling jobs, natural aluminium, 2 m		€ 13.95
970818	Combo installation connection profile for filling jobs, white, 2 m		€ 28.95
970816	Combo installation connection profile for filling jobs, black, 2 m		€ 28.95
988135	Combo concrete end cap transformer profile with edge covering, white		€ 2.95
988134	Combo concrete end cap transformer profile with edge covering, black		€ 2.95
988163	Combo concrete connecting piece mounting profile - transformer profile, white		€ 5.95
988162	Combo concrete connecting piece mounting profile - transformer profile, black		€ 5.95





PROFILE, SERIES COMBO, BUILT-IN, MOUNTING PROFILE

Housing Aluminium



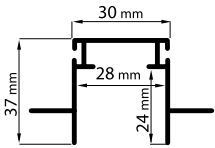







Article	Housing Color	Length	Price
970820	<input type="checkbox"/> Aluminium	1000 mm	€ 39.95
970821	<input checked="" type="checkbox"/> Black	1000 mm	€ 54.95
970822	<input type="checkbox"/> White	1000 mm	€ 54.95
970823	<input type="checkbox"/> Aluminium	2000 mm	€ 80.95
970824	<input checked="" type="checkbox"/> Black	2000 mm	€ 108.95
970825	<input type="checkbox"/> White	2000 mm	€ 108.95
970826	<input type="checkbox"/> Aluminium	3000 mm	€ 120.95
970827	<input checked="" type="checkbox"/> Black	3000 mm	€ 163.95
970828	<input type="checkbox"/> White	3000 mm	€ 163.95



Technical data sheet

New in the onlineshop: The technical data sheets offer even more information: Light and energy data, light distribution curves, dimensional drawings and more.

Accessories

988180	Combo stucco moulding - flush - polystyrene 24x29x1000		€ 8.95
988179	Combo stucco moulding - plaster edge - polystyrene 40x29x1000		€ 8.95
970814	Combo installation connection profile for filling jobs, natural aluminium, 2 m		€ 13.95
970818	Combo installation connection profile for filling jobs, white, 2 m		€ 28.95
970816	Combo installation connection profile for filling jobs, black, 2 m		€ 28.95
988174	Combo recessed connector and fall protection		€ 22.95
988177	Combo built-in/insulation connector set (2 pcs) 0/0		€ 11.95
988178	Combo built-in/insulation connector set (2 pcs) 0/90		€ 11.95
988175	Combo built-in/insulation connector set (2 pcs) 90/0		€ 11.95
988137	Combo built-in/insulation end cap mounting profile without web, white		€ 2.95
988136	Combo built-in/insulation end cap mounting profile without web, black		€ 2.95

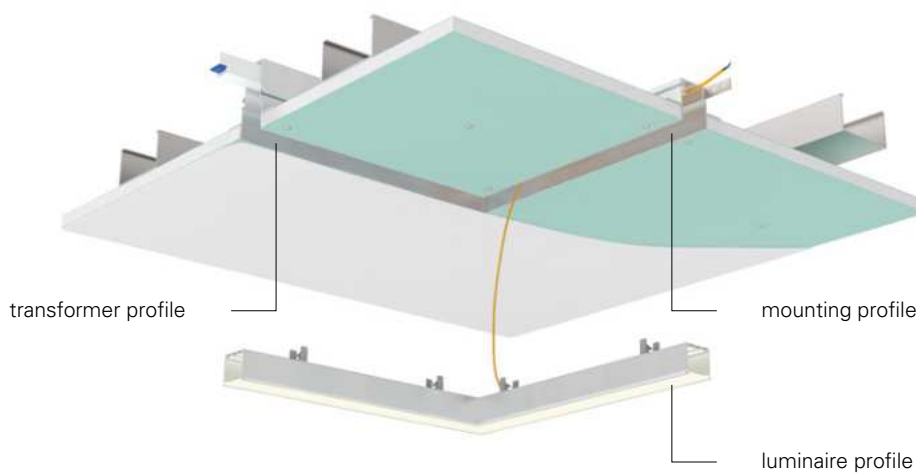









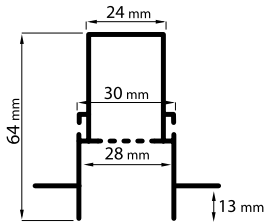







PROFILE, SERIES COMBO, BUILT-IN, TRANSFORMER PROFILE

Housing Aluminium

Article	Housing Color	Length	Price
970833	Aluminium	1000 mm	€ 57.95
970834	Black	1000 mm	€ 107.95
970835	White	1000 mm	€ 107.95
970836	Aluminium	2000 mm	€ 114.95
970837	Black	2000 mm	€ 215.95
970838	White	2000 mm	€ 215.95
970839	Aluminium	3000 mm	€ 172.95
970840	Black	3000 mm	€ 273.95
970841	White	3000 mm	€ 273.95



Accessories

988180	Combo stucco moulding - flush - polystyrene 24x29x1000		€ 8.95
988179	Combo stucco moulding - plaster edge - polystyrene 40x29x1000		€ 8.95
970814	Combo installation connection profile for filling jobs, natural aluminium, 2 m		€ 13.95
970818	Combo installation connection profile for filling jobs, white, 2 m		€ 28.95
970816	Combo installation connection profile for filling jobs, black, 2 m		€ 28.95
988174	Combo recessed connector and fall protection		€ 22.95
988177	Combo built-in/insulation connector set (2 pcs) 0/0		€ 11.95
988178	Combo built-in/insulation connector set (2 pcs) 0/90		€ 11.95
988175	Combo built-in/insulation connector set (2 pcs) 90/0		€ 11.95
988141	Combo built-in/isolation end cap transformer profile, white		€ 2.95
988138	Combo built-in/isolation end cap transformer profile, black		€ 2.95
988140	Combo built-in/insulation end cap connecting piece mounting profile/transformer profile, white		€ 2.95
988139	Combo built-in/insulation end cap connecting piece mounting profile/transformer profile, black		€ 2.95











PROFILES, COMBO SERIES, INSULATION, MOUNTING PROFILE

Housing EPS Length 2000 mm

Article	Housing Color	Price
988170	■ Black	€ 503.95
988171	□ White	€ 503.95

Accessories

988180	Combo stucco moulding - flush - polystyrene 24x29x1000		€ 8.95
988178	Combo built-in/insulation connector set (2 pcs) 0/90		€ 11.95
988175	Combo built-in/insulation connector set (2 pcs) 90/0		€ 11.95
988177	Combo built-in/insulation connector set (2 pcs) 0/0		€ 11.95
988137	Combo built-in/insulation end cap mounting profile without web, white		€ 2.95
988136	Combo built-in/insulation end cap mounting profile without web, black		€ 2.95



Technical data sheet

New in the onlineshop: The technical data sheets offer even more information: Light and energy data, light distribution curves, dimensional drawings and more.











PROFILES, COMBO SERIES, INSULATION, TRANSFORMER PROFILE

Housing EPS Length 1000 mm

Article	Housing Color	Price
988172	■ Black	€ 273.95
988173	□ White	€ 273.95

Accessories

988180	Combo stucco moulding - flush - polystyrene 24x29x1000		€ 8.95
988178	Combo built-in/insulation connector set (2 pcs) 0/90		€ 11.95
988175	Combo built-in/insulation connector set (2 pcs) 90/0		€ 11.95
988177	Combo built-in/insulation connector set (2 pcs) 0/0		€ 11.95
988141	Combo built-in/insulation end cap transformer profile, white		€ 2.95
988138	Combo built-in/insulation end cap transformer profile, black		€ 2.95
988140	Combo built-in/insulation end cap connecting piece mounting profile/transformer profile, white		€ 2.95
988139	Combo built-in/insulation end cap connecting piece mounting profile/transformer profile, black		€ 2.95



Lighting design

Interested in our lighting design service?

Your contact person will be happy to answer any questions you may have.



PROFILE, SERIES COMBO, CLICK U-PROFILE

Housing

Aluminium

Article	Housing Color	Surface	Length	Price
970845	Black		1000 mm	€ 34.95
970848	White		1000 mm	€ 34.95
970846	Black		2000 mm	€ 68.95
970849	White		2000 mm	€ 68.95
970847	Black		3000 mm	€ 103.95
970850	White		3000 mm	€ 103.95
970842	Silver	Anodised	1000 mm	€ 31.95
970843	Silver	Anodised	2000 mm	€ 62.95
970844	Silver	Anodised	3000 mm	€ 94.95

Accessories

988126	Combo click cover V5-U-2510 opal, 1 m		€ 18.95
988127	Combo click cover V5-U-2510 opal, 2 m		€ 36.95
988128	Combo click cover V5-U-2510 opal, 3 m		€ 55.95
988122	Combo click cover V3-UP-50 opal, 1 m		€ 14.95
988120	Combo click cover V3-UP-50 opal, 2 m		€ 28.95
988121	Combo click cover V3-UP-50 opal, 3 m		€ 42.95
988123	Combo click cover V4-HL-25 opal, 1 m		€ 11.95
988124	Combo click cover V4-HL-25 opal, 2 m		€ 22.95
988125	Combo click cover V4-HL-25 opal, 3 m		€ 34.95
988148	Combo click U-Profile end cap, V1-AP-25, metallised, 1 piece		€ 16.95
988146	Combo click U-Profile end cap, V1-AP-25, white, 1 piece		€ 2.95
988145	Combo click U-Profile end cap, V1-AP-25, black, 1 piece		€ 2.95
988147	Combo click U-Profile end cap, V3-UP-50, opal matt, 1 piece		€ 6.95
988142	Combo click U-Profile end cap, 25 + V5-U-2510, metallised, 1 piece		€ 16.95
988144	Combo click U-Profile end cap, 25 + V5-U-2510, white, 1 piece		€ 3.95
988143	Combo click U-Profile end cap, 25 + V5-U-2510, black, 1 piece		€ 3.95



PROFILE, SERIES COMBO, CLICK T-PROFILE

Housing Aluminium

Article	Housing Color	Surface	Length	Price
970863	Black		1000 mm	€ 39.95
970866	White		1000 mm	€ 39.95
970864	Black		2000 mm	€ 80.95
970867	White		2000 mm	€ 80.95
970865	Black		3000 mm	€ 120.95
970868	White		3000 mm	€ 120.95
970860	Silver	Anodised	1000 mm	€ 35.95
970861	Silver	Anodised	2000 mm	€ 71.95
970862	Silver	Anodised	3000 mm	€ 107.95

Accessories

988122	Combo click cover V3-UP-50 opal, 1 m		€ 14.95
988120	Combo click cover V3-UP-50 opal, 2 m		€ 28.95
988121	Combo click cover V3-UP-50 opal, 3 m		€ 42.95
988123	Combo click cover V4-HL-25 opal, 1 m		€ 11.95
988124	Combo click cover V4-HL-25 opal, 2 m		€ 22.95
988125	Combo click cover V4-HL-25 opal, 3 m		€ 34.95
988126	Combo click cover V5-U-2510 opal, 1 m		€ 18.95
988127	Combo click cover V5-U-2510 opal, 2 m		€ 36.95
988128	Combo click cover V5-U-2510 opal, 3 m		€ 55.95
988158	Combo click T-Profile end cap, 35 F, metallised, 1 pcs		€ 8.95
988160	Combo click T-Profile end cap, 35 F, white, 1 pcs		€ 3.95
988159	Combo click T-Profile end cap, 35 F, black, 1 pcs		€ 3.95
988155	Combo click T-Profile end cap, 35 F + V5-U-2510, metallised, 1 pcs		€ 8.95
988157	Combo click T-Profile end cap, 35 F + V5-U-2510, white, 1 pcs		€ 3.95
988156	Combo click T-Profile end cap, 35 F + V5-U-2510, black, 1 pcs		€ 3.95
988198	Combo click T-Profile mounting spring set (2 pieces)		€ 3.95



ALUMINIUM PROFILES

- 574 linear light in 5 steps
- 576 aluminium profiles | overview
- 587 assembly for profiles and stripes
- 580 homogeneous light image
- 582 U-profiles | flat + high | built-in/built-on
- 605 T-profiles | flat + high | built-in
- 624 H- und groove-profiles
- 632 step/plinth/angle/corner-profiles | built-in/built-on
- 658 dry construction profiles
- 678 tile profiles
- 694 profiles for outdoor use | walkable/trafficable

LINEAR LIGHT IN 5 STEPS

STEP BY STEP TO BECOMING A LINEAR LIGHT PROFESSIONAL!

It has never been quicker and easier to put together an individually and perfectly coordinated linear light in max. 5 steps. Test how quickly and easily you can put your personal project into practice.

1

CHOOSE YOUR PROFILE

Whether for indoor or outdoor use, for wide or narrow LED stripes, whether the profile is to be should be low or high. Matching to this you can choose between different shapes and light transmittance of the covers.

2

CHOOSE THE RIGHT LED STRIPE

You can choose between strips for indoor or outdoor use, with one or more light colours, high-power strips for basic lighting or fewer lumens for ambient lighting. Various cut sizes and LED spacing also perfectly round off our range here.



3

SELECT THE REQUIRED POWER SUPPLY

In addition to the various protection classes for the respective place of use and voltages, you can choose from different designs and power classes. Our range is complemented by power supplies that can be dimmed directly or controlled via Dali, KNX or 1-10V.

4

DO YOU NEED A CONTROLLER TO STEER?

In this category, you can select the appropriate control controller or LED dimmer according to requirements and customer wishes. Whether control via radio, smartphone, DMX, Dali, etc. – almost no [control] wishes remain unfulfilled!



5

ACCESSORIES, MOUNTING MATERIAL & CO

In the last step, you will find everything that makes installation easier, faster and more comfortable and gives the linear desired light a perfect finish.

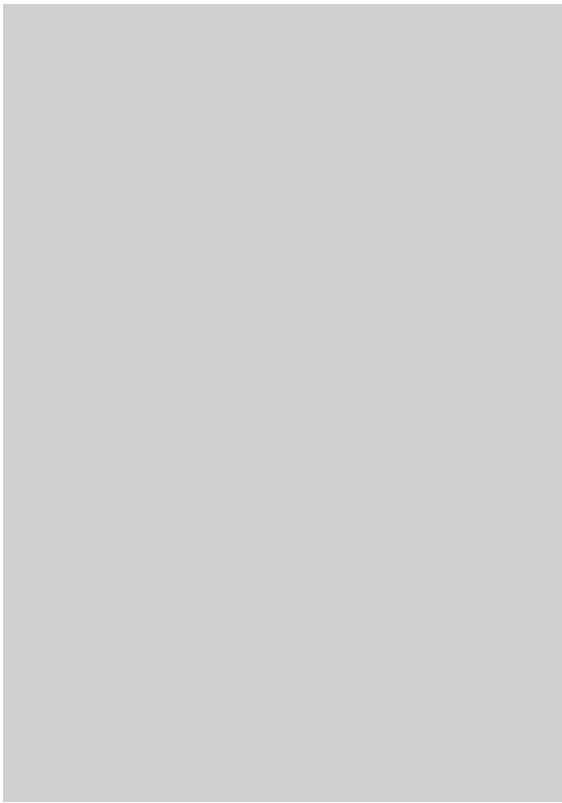

■ □
page 584



■ ■ □
page 606



■
page 626



■
page 628



■ □
page 630



■
page 634

aluminium profiles



■
page 638



■
page 640



■ ■ □
page 642



■ □
page 646



■ □
page 648



■
page 650



□
page 652



□ □
page 660



□ □
page 662



□ □
page 664



□
page 666



□
page 668



□
page 670



□
page 672



□
page 674



□
page 676



□
page 680



□ □
page 682



□ □
page 684



□
page 686



□
page 690



□
page 696



□
page 698



□
page 700



□
page 702



□
page 704





ASSEMBLY FOR PROFILES AND STRIPES

We provide our products individually made to measure on request.
You will receive the prices on request.



989100 – service package I – profile cut

profile is shortened to desired length, tolerance ± 1 mm | sawing loss 4 mm

989105 – drill hole end cap / profile

hole for cable outlet in end cap or profile



989200 – service package II – cover cut

cover is shortened to desired length, tolerance ± 1 mm | sawing loss 4 mm



989300 – service package III – stripe cut

LED stripe is adapted to desired length, taking into account segment and maximum total length, including soldering of a cable lead of the desired length and open, tinned wire ends

989305 – cable – connecting cable / cores 1 channel

989310 – cable – connecting cable / cores 2 channel

989315 – cable – connecting cable / cores 3 + 4 channel

989320 – cable – mini cable / cores 1 - 4 channel

989325 – cable – connecting cable / cores 5 channel

989301 – 2nd connecting cable

attachment of a 2nd connecting cable / cores for further connection with open tinned wire ends

989302 – connecting cable

attaching / soldering a fixed connection line / cores between 2 stripe pieces

[max. 1m connection line / cores incl., a longer connection will be charged by the metre]

original length and max. total length of the strip to be operated may not be exceeded by sections to be exceeded

989350 – IP surcharge – sealing stripe

sealing a shortened IP stripe / gluing an end cap



989400 – service package IV – complete assembly

bringing together and assembling all components into a finished luminaire
incl. function test and cable flag

[for desired length, please add 2cm to the cut length of the LED stripe segment
for connection space, length tolerance ± 2 mm]



HOMOGENEOUS LIGHT IMAGE

How to achieve a homogeneous light image

In combination with a milky 40% cover and a matching LED stripe, a homogeneous light image can be created. The distance [pixel pitch] between the LEDs and the cover is decisive.

The rule of thumb here is:

The distance between the LEDs should be smaller than the distance between the LEDs and the cover.

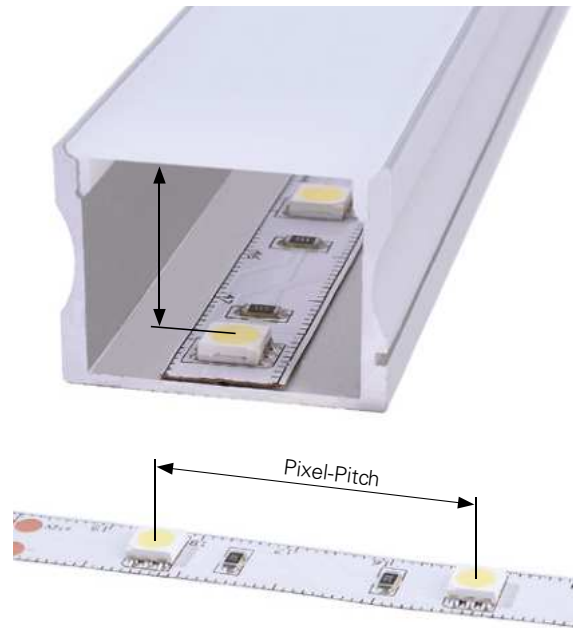

PROFILE DESCRIPTION

mounting type: A = built-on
E = built-in

Width of the series [10 profile] / of the matching LED stripe

AU - 01 - 10

basic form series

TRANSLUCENCY / LIGHT TRANSMISSION

95% clear

75% mat

40% milky



Illustration of various LED stripes with different pixel pitches in combination with three different light transmittances in the covers. This small selection clearly illustrates the optical differences of some LED stripes in combination with different covers.

120 LED/m
cutting option 50 mm / 6 LED



240 LED/m
cutting option 25 mm / 6 LED



700LED/m
cutting option 10 mm / 7 LED

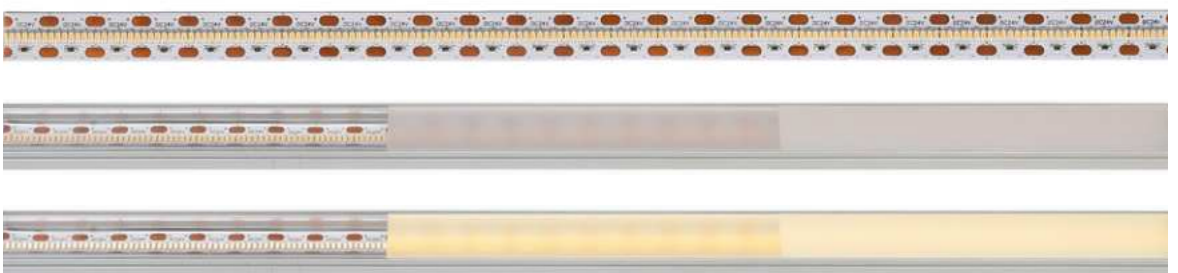

COB 480 LED/m
cutting option 50 mm / 24 LED





With the kind support of BEST Bellemann Elektro Service Team GmbH, Rauenberg-Malschenberg



U- AND T-PROFILES

The profiles of these series are available in various designs. Thanks to their universal profile shape, they can be used flexibly in almost all areas. Thanks to their profile construction, they are ideally suited for the cover cut edges.



AU-01-05

·for LED strips up to 5.7 mm wide

Housing Aluminium
Length 2000 mm

Article	Housing Color	Surface	Price
970085	<input type="checkbox"/> White		€ 15.95
970081	<input type="checkbox"/> Silver	Anodised	€ 17.95

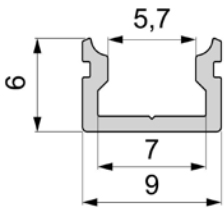

Cover | PMMA - Polymethyl methacrylate

Clear Milky



2 m **983551** **983555** € 11.95
 3 m **983556** € 18.95



2 m **984055** € 11.95



2 m **984555** € 11.95

end caps set | 2 pieces | Plastic | € 4.95

White Grey Black

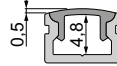

978660 **978661** **978662**

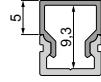

979160 **979161** **979162**

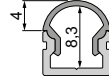

979660 **979661** **979662**





AU-02-05

·for LED strips up to 5.7 mm wide

Housing

Aluminium

Article	Housing Color	Surface	Length	Price
970185	<input type="checkbox"/> White		2000 mm	€ 18.95
970180	<input type="checkbox"/> Silver	Anodised	1000 mm	€ 9.95
970181	<input type="checkbox"/> Silver	Anodised	2000 mm	€ 18.95
970183	<input type="checkbox"/> Black	Brushed	2000 mm	€ 18.95

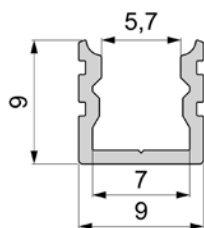

Cover | PMMA - Polymethyl methacrylate

Clear Milky



1 m **983550** **983554** € 5.95

2 m **983551** **983555** € 11.95

3 m **983556** € 18.95



1 m **984054** € 5.95

2 m **984055** € 11.95



1 m **984554** € 5.95

2 m **984555** € 11.95

end caps set | 2 pieces | Plastic | € 4.95

White Grey Black



978670 **978671** **978672**



979170 **979171** **979172**



979670 **979671**





AU-01-08

·for LED strips up to 9.3 mm wide

Housing Aluminium

Article	Housing Color	Surface	Length	Price
970005	<input type="checkbox"/> White		2000 mm	€ 23.95
970000	<input type="checkbox"/> Silver	Anodised	1000 mm	€ 11.95
970001	<input type="checkbox"/> Silver	Anodised	2000 mm	€ 23.95
970003	<input type="checkbox"/> Black	Anodised	2000 mm	€ 23.95
970008	<input type="checkbox"/> Silver	Anodised	3000 mm	€ 35.95
970007	<input type="checkbox"/> Silver	Brushed	2000 mm	€ 23.95

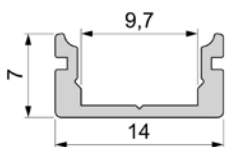

Cover | PMMA - Polymethyl methacrylate

Clear Matt Milky



1 m	983000	983002	983004	€ 7.95
2 m	983001	983003	983005	€ 17.95
3 m	983006	983007	983008	€ 25.95



1 m	983500	983502	983504	€ 7.95
2 m	983501	983503	983505	€ 17.95
3 m		983506	983508	€ 25.95



1 m		984002	984004	€ 7.95
2 m		984003	984005	€ 17.95



1 m		984502	984504	€ 7.95
2 m		984503	984505	€ 17.95

end caps set | 2 pieces | Plastic | € 4.95

White Grey Black

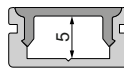

978000 **978001** **978002**

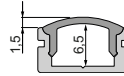

978500 **978501** **978502**

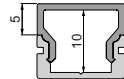

979080 **979081** **979082**

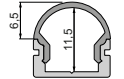

979580 **979581** **979582**

Accessories

930347 3M doublesided tape 50000x12x0,2mm



€ 31.95

987002 Set of 2 retaining clips for AU-08



€ 3.95

987080 Universal holding clip mount (swivel) set of 2 pieces



€ 23.95





AU-02-08

·for LED strips up to 9.3 mm wide

Housing Aluminium

Article	Housing Color	Surface	Length	Price
970105	<input type="checkbox"/> White		2000 mm	€ 28.95
970101	<input type="checkbox"/> Silver	Anodised	2000 mm	€ 28.95
970103	<input type="checkbox"/> Black	Anodised	2000 mm	€ 28.95
970108	<input type="checkbox"/> Silver	Anodised	3000 mm	€ 42.95

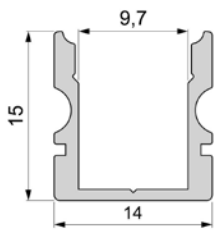



Cover | PMMA - Polymethyl methacrylate

Clear Matt Milky

				
2 m	983001	983003	983005	€ 17.95
3 m	983006	983007	983008	€ 25.95

				
2 m	983501	983503	983505	€ 17.95
3 m			983506	€ 25.95

				
2 m		984003	984005	€ 17.95

				
2 m		984503	984505	€ 17.95

end caps set | 2 pieces | Plastic | € 4.95

White Grey Black

			
978040	978041	978042	

			
978540	978541	978542	

			
979100	979101	979102	

			
979600	979601	979602	

Accessories

930347 3M doublesided tape 50000x12x0,2mm



€ 31.95

987002 Set of 2 retaining clips for AU-08



€ 3.95

987080 Universal holding clip mount (swivel) set of 2 pieces



€ 23.95





AU-01-10

·for LED strips up to 11.3 mm wide

Housing

Aluminium

Article	Housing Color	Surface	Length	Price
970025	<input type="checkbox"/> White		2000 mm	€ 23.95
970020	<input type="checkbox"/> Silver	Anodised	1000 mm	€ 11.95
970021	<input type="checkbox"/> Silver	Anodised	2000 mm	€ 23.95
970023	<input type="checkbox"/> Black	Anodised	2000 mm	€ 23.95
970028	<input type="checkbox"/> Silver	Anodised	3000 mm	€ 35.95
970029	<input type="checkbox"/> Silver	Anodised	4000 mm	€ 49.95
970027	<input type="checkbox"/> Silver	Brushed	2000 mm	€ 23.95

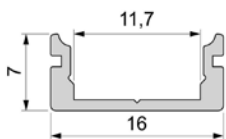



Cover | PMMA - Polymethyl methacrylate

Clear Matt Milky

				
1 m	983010	983012	983014	€ 7.95
2 m	983011	983013	983015	€ 17.95
3 m	983016	983017	983018	€ 25.95
4 m	983060	983061	983062	€ 33.95

				
1 m	983510	983512	983514	€ 7.95
2 m	983511	983513	983515	€ 17.95
3 m	983516	983517	983518	€ 25.95
4 m	983560	983561	983562	€ 33.95

				
1 m		984012	984014	€ 7.95
2 m		984013	984015	€ 17.95
3 m		984017	984018	€ 25.95
4 m		984010	984011	€ 33.95

				
1 m		984512	984514	€ 7.95
2 m		984513	984515	€ 17.95
3 m		984517	984518	€ 25.95
4 m		984510	984511	€ 33.95

				
1 m	985010			€ 7.95
2 m	985011			€ 17.95
3 m	985016			€ 25.95

end caps set | 2 pieces | Plastic | € 4.95

White Grey Black

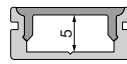

978010 978011 978012

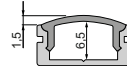

978510 978511 978512

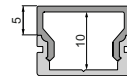

979000 979001 979002

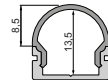

979500 979501 979502

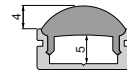

980000 980001 980002

Accessories

930348 3M doublesided tape 50000x15x0,2mm



€ 38.95

987004 Set of 2 retaining clips for AU-10



€ 3.95

987080 Universal holding clip mount (swivel) set of 2 pieces



€ 23.95



AU-02-10

·for LED strips up to 11.3 mm wide

Housing Aluminium

Article	Housing Color	Surface	Length	Price
970125	<input type="checkbox"/> White		2000 mm	€ 28.95
970120	<input type="checkbox"/> Silver	Anodised	1000 mm	€ 14.95
970121	<input type="checkbox"/> Silver	Anodised	2000 mm	€ 28.95
970123	<input type="checkbox"/> Black	Anodised	2000 mm	€ 28.95
970128	<input type="checkbox"/> Silver	Anodised	3000 mm	€ 44.95
970129	<input type="checkbox"/> Silver	Anodised	4000 mm	€ 59.95

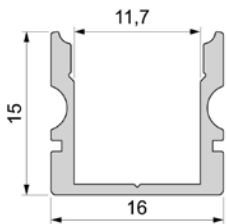



Cover | PMMA - Polymethyl methacrylate

Clear Matt Milky

				
1 m	983010	983012	983014	€ 7.95
2 m	983011	983013	983015	€ 17.95
3 m	983016	983017	983018	€ 25.95
4 m	983060	983061	983062	€ 33.95

				
1 m	983510	983512	983514	€ 7.95
2 m	983511	983513	983515	€ 17.95
3 m	983516	983517	983518	€ 25.95
4 m	983560	983561	983562	€ 33.95

				
1 m		984012	984014	€ 7.95
2 m		984013	984015	€ 17.95
3 m		984017	984018	€ 25.95
4 m		984010	984011	€ 33.95

				
1 m		984512	984514	€ 7.95
2 m		984513	984515	€ 17.95
3 m		984517	984518	€ 25.95
4 m		984510	984511	€ 33.95

				
1 m	985010			€ 7.95
2 m	985011			€ 17.95
3 m	985016			€ 25.95

end caps set | 2 pieces | Plastic | € 4.95

White Grey Black

			
978050	978051	978052	

			
978550	978551	978552	

			
979020	979021	979022	

			
979520	979521	979522	

			
980010	980011	980012	

Accessories

930348 3M doublesided tape 50000x15x0,2mm



€ 38.95

987004 Set of 2 retaining clips for AU-10



€ 3.95

987080 Universal holding clip mount (swivel) set of 2 pieces



€ 23.95



AU-01-12

·for LED strips up to 13.3 mm wide

Housing

Aluminium

Article	Housing Color	Surface	Length	Price
970045	<input type="checkbox"/> White		2000 mm	€ 28.95
970040	<input type="checkbox"/> Silver	Anodised	1000 mm	€ 14.95
970041	<input type="checkbox"/> Silver	Anodised	2000 mm	€ 28.95
970043	<input type="checkbox"/> Black	Anodised	2000 mm	€ 28.95
970048	<input type="checkbox"/> Silver	Anodised	3000 mm	€ 42.95
970047	<input type="checkbox"/> Silver	Brushed	2000 mm	€ 28.95

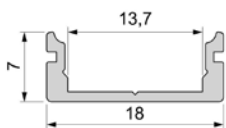



Cover | PMMA - Polymethyl methacrylate

Clear Matt Milky

				
1 m	983020	983022	983024	€ 7.95
2 m	983021	983023	983025	€ 17.95
3 m	983028	983027	983026	€ 25.95

				
1 m	983520	983522	983524	€ 7.95
2 m	983521	983523	983525	€ 17.95
3 m	983527		983526	€ 25.95

				
1 m		984022	984024	€ 7.95
2 m		984023	984025	€ 17.95
3 m			984026	€ 25.95

				
1 m		984522	984524	€ 7.95
2 m		984523	984525	€ 17.95
3 m			984526	€ 25.95

end caps set | 2 pieces | Plastic | € 4.95

White Grey Black

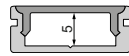

978020 **978021** **978022**

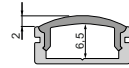

978520 **978521** **978522**

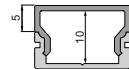

979010 **979011** **979012**

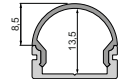

979510 **979511** **979512**

Accessories

930348 3M doublesided tape 50000x15x0,2mm



€ 38.95

987006 Set of 2 retaining clips for AU-12



€ 3.95

987080 Universal holding clip mount (swivel) set of 2 pieces



€ 23.95





AU-02-12

·for LED strips up to 13.3 mm wide

Housing

Aluminium

Article	Housing Color	Surface	Length	Price
970145	<input type="checkbox"/> White		2000 mm	€ 31.95
970140	<input type="checkbox"/> Silver	Anodised	1000 mm	€ 15.95
970141	<input type="checkbox"/> Silver	Anodised	2000 mm	€ 31.95
970143	<input type="checkbox"/> Black	Anodised	2000 mm	€ 31.95
970148	<input type="checkbox"/> Silver	Anodised	3000 mm	€ 44.95
970147	<input type="checkbox"/> Silver	Brushed	2000 mm	€ 31.95

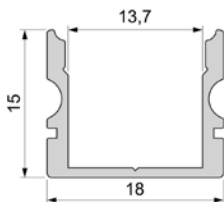



Cover | PMMA - Polymethyl methacrylate

Clear Matt Milky

				
1 m	983020	983022	983024	€ 7.95
2 m	983021	983023	983025	€ 17.95
3 m	983028	983027	983026	€ 25.95

				
1 m	983520	983522	983524	€ 7.95
2 m	983521	983523	983525	€ 17.95
3 m	983527		983526	€ 25.95

				
1 m		984022	984024	€ 7.95
2 m		984023	984025	€ 17.95
3 m			984026	€ 25.95

				
1 m		984522	984524	€ 7.95
2 m		984523	984525	€ 17.95
3 m			984526	€ 25.95

end caps set | 2 pieces | Plastic | € 4.95

White Grey Black



978060 **978061** **978062**



978560 **978561** **978562**



979030 **979031** **979032**



979530 **979531** **979532**

Accessories

930348 3M doublesided tape 50000x15x0,2mm



€ 38.95

987006 Set of 2 retaining clips for AU-12



€ 3.95

987080 Universal holding clip mount (swivel) set of 2 pieces



€ 23.95

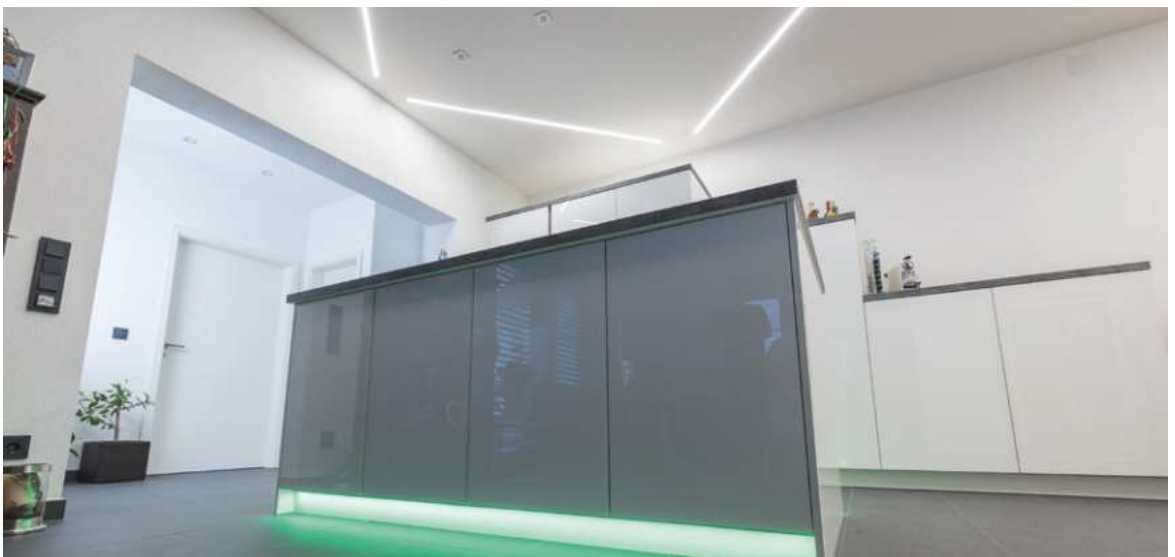



AU-01-15

·for LED strips up to 16.3 mm wide

Housing

Aluminium

Article	Housing Color	Surface	Length	Price
970065	<input type="checkbox"/> White		2000 mm	€ 28.95
970060	<input type="checkbox"/> Silver	Anodised	1000 mm	€ 14.95
970061	<input type="checkbox"/> Silver	Anodised	2000 mm	€ 28.95
970063	<input type="checkbox"/> Black	Anodised	2000 mm	€ 28.95
970068	<input type="checkbox"/> Silver	Anodised	3000 mm	€ 42.95

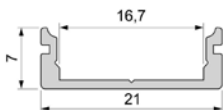



Cover | PMMA - Polymethyl methacrylate

Clear Matt Milky

				
1 m	983030	983032	983034	€ 9.95
2 m	983031	983033	983035	€ 19.95
3 m	983038	983037	983036	€ 28.95

				
1 m	983530	983532	983534	€ 9.95
2 m	983531	983533	983535	€ 19.95
3 m		983539	983536	€ 28.95

				
1 m		984032	984034	€ 9.95
2 m		984033	984035	€ 19.95
3 m			984036	€ 28.95

				
1 m		984532	984534	€ 9.95
2 m		984533	984535	€ 19.95

end caps set | 2 pieces | Plastic | € 4.95

White Grey Black

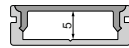

978030 **978031** **978032**

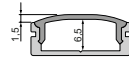

978530 **978531** **978532**

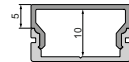

979090 **979091** **979092**

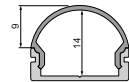

979590 **979591** **979592**

Accessories

930349 3M doublesided tape 50000x20x0,2mm



€ 48.95

987008 Set of 2 retaining clips for AU-15



€ 3.95

987080 Universal holding clip mount (swivel) set of 2 pieces



€ 23.95

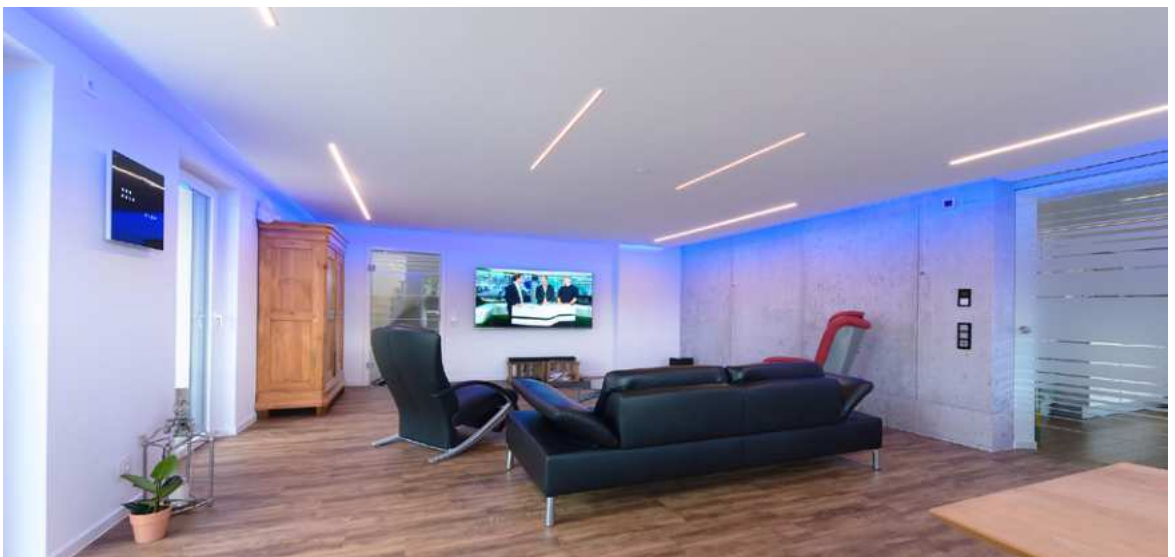



AU-02-15

·for LED strips up to 16.3 mm wide

Housing

Aluminium

Article	Housing Color	Surface	Length	Price
970165	<input type="checkbox"/> White		2000 mm	€ 31.95
970160	<input type="checkbox"/> Silver	Anodised	1000 mm	€ 15.95
970161	<input type="checkbox"/> Silver	Anodised	2000 mm	€ 31.95
970163	<input type="checkbox"/> Black	Anodised	2000 mm	€ 31.95
970168	<input type="checkbox"/> Silver	Anodised	3000 mm	€ 44.95

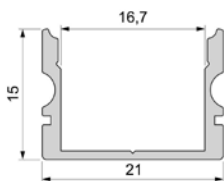



Cover | PMMA - Polymethyl methacrylate

Clear Matt Milky

				
1 m	983030	983032	983034	€ 9.95
2 m	983031	983033	983035	€ 19.95
3 m	983038	983037	983036	€ 28.95

				
1 m	983530	983532	983534	€ 9.95
2 m	983531	983533	983535	€ 19.95
3 m		983539	983536	€ 28.95

				
1 m		984032	984034	€ 9.95
2 m		984033	984035	€ 19.95
3 m			984036	€ 28.95

				
1 m		984532	984534	€ 9.95
2 m		984533	984535	€ 19.95

end caps set | 2 pieces | Plastic | € 4.95

White Grey Black

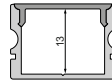

978070 **978071** **978072**

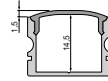

978570 **978571** **978572**

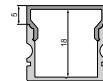

979110 **979111** **979112**



979610 **979611** **979612**

Accessories

930349 3M doublesided tape 50000x20x0,2mm



€ 48.95

987008 Set of 2 retaining clips for AU-15



€ 3.95

987080 Universal holding clip mount (swivel) set of 2 pieces



€ 23.95





AU-02-20

·for LED strips up to 21.3 mm wide

Housing Aluminium
Surface Anodised

Article	Housing Color	Length	Price
970201	<input type="checkbox"/> Silver	2000 mm	€ 37.95
970202	<input type="checkbox"/> Silver	3000 mm	€ 59.95

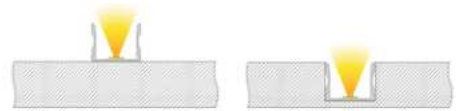
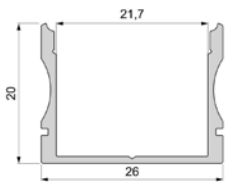

Cover | PMMA - Polymethyl methacrylate

Clear Milky



1 m	983040	983044	€ 11.5
2 m	983041	983045	€ 21.95
3 m		983046	€ 32.95



1 m		984044	€ 11.5
2 m		984045	€ 21.95



1 m		984544	€ 11.5
2 m		984545	€ 21.95

end caps set | 2 pieces | Plastic | € 4.95

end caps set | Plastic | € 4.95

Grey

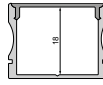

978161



978351



978361

Accessories

930350 3M doublesided tape 50000x25x0,2mm

987010 Set of 2 retaining clips for AU-20

987080 Universal holding clip mount (swivel) set of 2 pieces



€ 56.95

€ 3.95

€ 23.95





ET-01-05

·for LED strips up to 5.7 mm wide

Housing Aluminium
Length 2000 mm

Article	Housing Color	Surface	Price
975085	<input type="checkbox"/> White		€ 17.95
975081	<input type="checkbox"/> Silver	Anodised	€ 17.95
975083	<input type="checkbox"/> Black	Brushed	€ 17.95

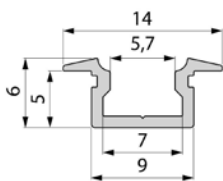

Cover | PMMA - Polymethyl methacrylate

Clear Milky



1 m	983550	983554	€ 5.95
2 m	983551	983555	€ 11.95
3 m		983556	€ 18.95



1 m		984054	€ 5.95
2 m		984055	€ 11.95



1 m		984554	€ 5.95
2 m		984555	€ 11.95

end caps set | 2 pieces | Plastic | € 4.95

White Grey Black

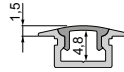

978680	978681	978682
---------------	---------------	---------------

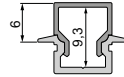

979180	979181	979182
---------------	---------------	---------------

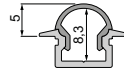

979681	979682
---------------	---------------





ET-01-08

·for LED strips up to 9.3 mm wide

Housing Aluminium

Article	Housing Color	Surface	Length	Price
975005	<input type="checkbox"/> White		2000 mm	€ 26.95
975001	<input type="checkbox"/> Silver	Anodised	2000 mm	€ 26.95
975003	<input type="checkbox"/> Black	Anodised	2000 mm	€ 26.95
975008	<input type="checkbox"/> Silver	Anodised	3000 mm	€ 38.95

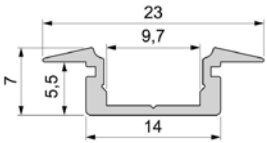

Cover | PMMA - Polymethyl methacrylate

Clear Matt Milky



1 m	983000	983002	983004	€ 7.95
2 m	983001	983003	983005	€ 17.95
3 m	983006	983007	983008	€ 25.95



1 m	983500	983502	983504	€ 7.95
2 m	983501	983503	983505	€ 17.95
3 m		983506	983508	€ 25.95



1 m		984002	984004	€ 7.95
2 m		984003	984005	€ 17.95



1 m		984502	984504	€ 7.95
2 m		984503	984505	€ 17.95

end caps set | 2 pieces | Plastic | € 4.95

White Grey Black

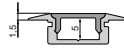

978080	978081	978082
---------------	---------------	---------------

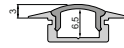

978580	978581	978582
---------------	---------------	---------------

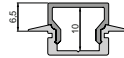

979120	979121	979122
---------------	---------------	---------------

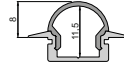

979620	979621	979622
---------------	---------------	---------------

Accessories

930347 3M doublesided tape 50000x12x0,2mm



€ 31.95

987002 Set of 2 retaining clips for AU-08



€ 3.95

987080 Universal holding clip mount (swivel) set of 2 pieces



€ 23.95





ET-02-08

·for LED strips up to 9.3 mm wide

Housing Aluminium

Article	Housing Color	Surface	Length	Price
975105	<input type="checkbox"/> White		2000 mm	€ 31.95
975101	<input type="checkbox"/> Silver	Anodised	2000 mm	€ 31.95
975103	<input type="checkbox"/> Black	Anodised	2000 mm	€ 31.95
975108	<input type="checkbox"/> Silver	Anodised	3000 mm	€ 44.95

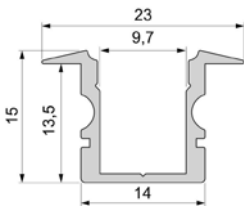

Cover | PMMA - Polymethyl methacrylate

Clear Matt Milky



1 m	983000	983002	983004	€ 7.95
2 m	983001	983003	983005	€ 17.95
3 m	983006	983007	983008	€ 25.95



1 m	983500	983502	983504	€ 7.95
2 m	983501	983503	983505	€ 17.95
3 m		983506	983508	€ 25.95



1 m		984002	984004	€ 7.95
2 m		984003	984005	€ 17.95



1 m		984502	984504	€ 7.95
2 m		984503	984505	€ 17.95

end caps set | 2 pieces | Plastic | € 4.95

White Grey Black

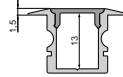

978120 **978121** **978122**

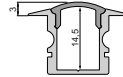

978620 **978621** **978622**

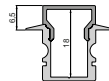

979140 **979141** **979142**



979641

Accessories

930347 3M doublesided tape 50000x12x0,2mm



€ 31.95

987002 Set of 2 retaining clips for AU-08



€ 3.95

987080 Universal holding clip mount (swivel) set of 2 pieces



€ 23.95





ET-01-10

·for LED strips up to 11.3 mm wide

Housing Aluminium

Article	Housing Color	Surface	Length	Price
975025	<input type="checkbox"/> White		2000 mm	€ 26.95
975021	<input type="checkbox"/> Silver	Anodised	2000 mm	€ 26.95
975023	<input type="checkbox"/> Black	Anodised	2000 mm	€ 26.95
975028	<input type="checkbox"/> Silver	Anodised	3000 mm	€ 38.95
975029	<input type="checkbox"/> Silver	Anodised	4000 mm	€ 53.95

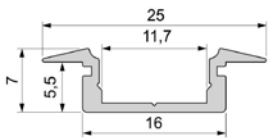

Cover | PMMA - Polymethyl methacrylate

Clear Matt Milky



1 m	983010	983012	983014	€ 7.95
2 m	983011	983013	983015	€ 17.95
3 m	983016	983017	983018	€ 25.95
4 m	983060	983061	983062	€ 33.95



1 m	983510	983512	983514	€ 7.95
2 m	983511	983513	983515	€ 17.95
3 m	983516	983517	983518	€ 25.95
4 m	983560	983561	983562	€ 33.95



1 m		984012	984014	€ 7.95
2 m		984013	984015	€ 17.95
3 m		984017	984018	€ 25.95
4 m		984010	984011	€ 33.95



1 m		984512	984514	€ 7.95
2 m		984513	984515	€ 17.95
3 m		984517	984518	€ 25.95
4 m		984510	984511	€ 33.95



1 m	985010			€ 7.95
2 m	985011			€ 17.95
3 m	985016			€ 25.95

end caps set | 2 pieces | Plastic | € 4.95

White Grey Black

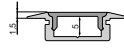

978090 978091 978092

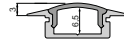

978590 978591 978592

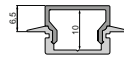

979040 979041 979042

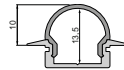

979540 979541 979542

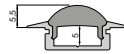

980040 980041 980042

Accessories

930348 3M doublesided tape 50000x15x0,2mm



€ 38.95

987004 Set of 2 retaining clips for AU-10



€ 3.95

987080 Universal holding clip mount (swivel) set of 2 pieces



€ 23.95



ET-02-10

·for LED strips up to 11.3 mm wide

Housing Aluminium

Article	Housing Color	Surface	Length	Price
975125	<input type="checkbox"/> White		2000 mm	€ 31.95
975121	<input type="checkbox"/> Silver	Anodised	2000 mm	€ 31.95
975123	<input type="checkbox"/> Black	Anodised	2000 mm	€ 31.95
975128	<input type="checkbox"/> Silver	Anodised	3000 mm	€ 44.95
975129	<input type="checkbox"/> Silver	Anodised	4000 mm	€ 64.95

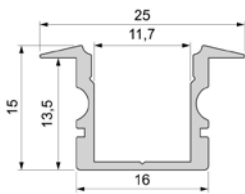



Cover | PMMA - Polymethyl methacrylate

Clear Matt Milky

				
1 m	983010	983012	983014	€ 7.95
2 m	983011	983013	983015	€ 17.95
3 m	983016	983017	983018	€ 25.95
4 m	983060	983061	983062	€ 33.95

				
1 m	983510	983512	983514	€ 7.95
2 m	983511	983513	983515	€ 17.95
3 m	983516	983517	983518	€ 25.95
4 m	983560	983561	983562	€ 33.95

				
1 m		984012	984014	€ 7.95
2 m		984013	984015	€ 17.95
3 m		984017	984018	€ 25.95
4 m		984010	984011	€ 33.95

				
1 m		984512	984514	€ 7.95
2 m		984513	984515	€ 17.95
3 m		984517	984518	€ 25.95
4 m		984510	984511	€ 33.95

				
1 m	985010			€ 7.95
2 m	985011			€ 17.95
3 m	985016			€ 25.95

end caps set | 2 pieces | Plastic | € 4.95

White Grey Black

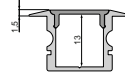

978130 **978131** **978132**

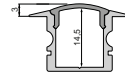

978630 **978631** **978632**

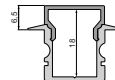

979060 **979061** **979062**



979560 **979561** **979562**

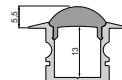

980060 **980061**

Accessories

930348 3M doublesided tape 50000x15x0,2mm



€ 38.95

987004 Set of 2 retaining clips for AU-10



€ 3.95

987080 Universal holding clip mount (swivel) set of 2 pieces



€ 23.95



ET-01-12

·for LED strips up to 13.3 mm wide

Housing Aluminium
 Length 2000 mm

Article	Housing Color	Surface	Price
975045	<input type="checkbox"/> White		€ 31.95
975041	<input checked="" type="checkbox"/> Silver	Anodised	€ 31.95

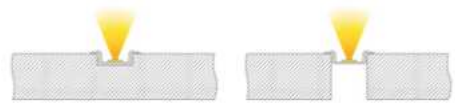
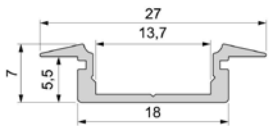



Cover | PMMA - Polymethyl methacrylate

Clear Matt Milky

					
1 m	983020	983022	983024	€ 7.95	
2 m	983021	983023	983025	€ 17.95	

					
1 m	983520	983522	983524	€ 7.95	
2 m	983521	983523	983525	€ 17.95	

					
1 m		984022	984024	€ 7.95	
2 m		984023	984025	€ 17.95	

					
1 m		984522	984524	€ 7.95	
2 m		984523	984525	€ 17.95	

end caps set | 2 pieces | Plastic | € 4.95

White Grey Black

					
	978100	978101	978102		

					
	978600	978601	978602		

					
	979050	979051	979052		

					
	979550	979551	979552		

Accessories

930348 3M doublesided tape 50000x15x0,2mm



€ 38.95

987006 Set of 2 retaining clips for AU-12



€ 3.95

987080 Universal holding clip mount (swivel) set of 2 pieces



€ 23.95





ET-02-12

·for LED strips up to 13.3 mm wide

Housing Aluminium

Article	Housing Color	Surface	Length	Price
975145	<input type="checkbox"/> White		2000 mm	€ 35.95
975141	<input type="checkbox"/> Silver	Anodised	2000 mm	€ 35.95
975143	<input type="checkbox"/> Black	Anodised	2000 mm	€ 35.95
975148	<input type="checkbox"/> Silver	Anodised	3000 mm	€ 54.95

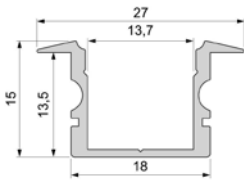



Cover | PMMA - Polymethyl methacrylate

Clear Matt Milky

				
1 m	983020	983022	983024	€ 7.95
2 m	983021	983023	983025	€ 17.95
3 m	983028	983027	983026	€ 25.95

				
1 m	983520	983522	983524	€ 7.95
2 m	983521	983523	983525	€ 17.95
3 m	983527		983526	€ 25.95

				
1 m		984022	984024	€ 7.95
2 m		984023	984025	€ 17.95
3 m			984026	€ 25.95

				
1 m		984522	984524	€ 7.95
2 m		984523	984525	€ 17.95
3 m			984526	€ 25.95

end caps set | 2 pieces | Plastic | € 4.95

White Grey Black

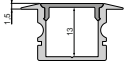
		
978140	978141	978142

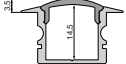
		
978640	978641	978642

		
979070	979071	979072

		
	979571	979572

Accessories

930348 3M doublesided tape 50000x15x0,2mm



987006 Set of 2 retaining clips for AU-12

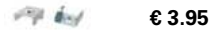

987080 Universal holding clip mount (swivel) set of 2 pieces



620 ALUMINIUM PROFILES | T-profiles - flat + high - built in



ET-01-15

·for LED strips up to 16.3 mm wide

Housing Aluminium
Length 2000 mm

Article	Housing Color	Surface	Price
975065	<input type="checkbox"/> White		€ 31.95
975061	<input type="checkbox"/> Silver	Anodised	€ 31.95
975063	<input type="checkbox"/> Black	Anodised	€ 31.95

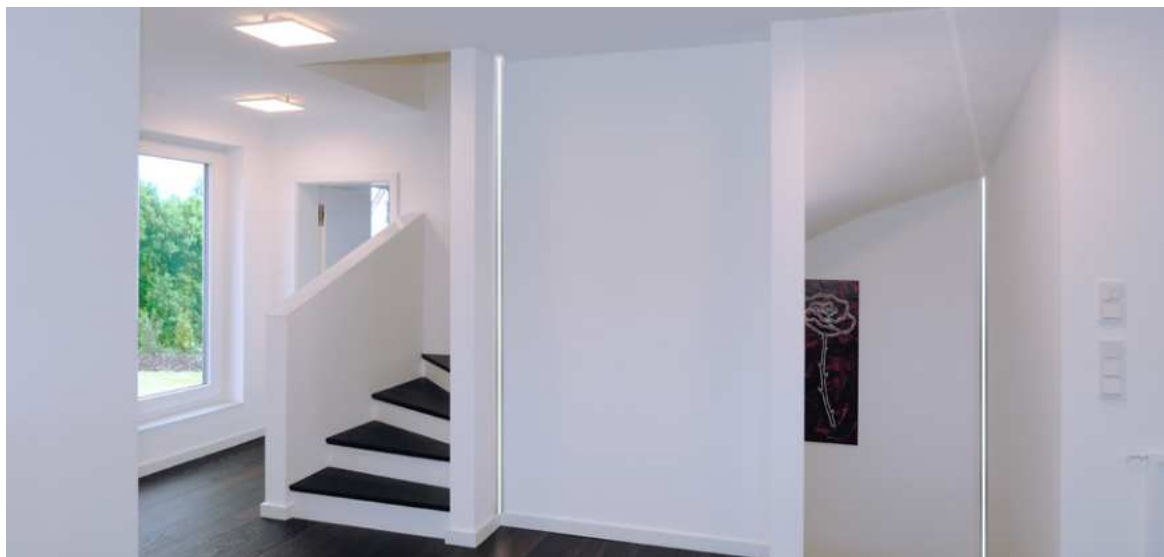
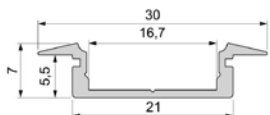



Cover | PMMA - Polymethyl methacrylate

Clear Matt Milky

					
1 m	983030	983032	983034	€ 9.95	
2 m	983031	983033	983035	€ 19.95	

					
1 m	983530	983532	983534	€ 9.95	
2 m	983531	983533	983535	€ 19.95	

					
1 m		984032	984034	€ 9.95	
2 m		984033	984035	€ 19.95	

					
1 m		984532	984534	€ 9.95	
2 m		984533	984535	€ 19.95	

end caps set | 2 pieces | Plastic | € 4.95

White Grey Black

				
978110	978111	978112		

				
978610	978611	978612		

				
979130	979131	979132		

				
979630	979631	979632		

Accessories

930349 3M doublesided tape 50000x20x0,2mm



€ 48.95

987008 Set of 2 retaining clips for AU-15



€ 3.95

987080 Universal holding clip mount (swivel) set of 2 pieces



€ 23.95





ET-02-15

·for LED strips up to 16.3 mm wide

Housing Aluminium

Article	Housing Color	Surface	Length	Price
975165	<input type="checkbox"/> White		2000 mm	€ 35.95
975161	<input type="checkbox"/> Silver	Anodised	2000 mm	€ 35.95
975163	<input type="checkbox"/> Black	Anodised	2000 mm	€ 35.95
975168	<input type="checkbox"/> Silver	Anodised	3000 mm	€ 54.95

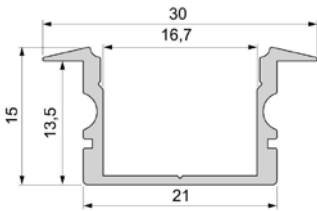



Cover | PMMA - Polymethyl methacrylate

Clear Matt Milky

				
1 m	983030	983032	983034	€ 9.95
2 m	983031	983033	983035	€ 19.95
3 m	983038	983037	983036	€ 28.95

				
1 m	983530	983532	983534	€ 9.95
2 m	983531	983533	983535	€ 19.95
3 m		983539	983536	€ 28.95

				
1 m		984032	984034	€ 9.95
2 m		984033	984035	€ 19.95
3 m			984036	€ 28.95

				
1 m		984532	984534	€ 9.95
2 m		984533	984535	€ 19.95

end caps set | 2 pieces | Plastic | € 4.95

White Grey Black

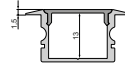

978150 978151 978152

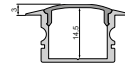

978650 978651 978652



979150 979151 979152

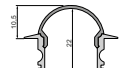

979650 979651 979652

Accessories

930349 3M doublesided tape 50000x20x0,2mm



€ 48.95

987008 Set of 2 retaining clips for AU-15



€ 3.95

987080 Universal holding clip mount (swivel) set of 2 pieces



€ 23.95





With the kind support of BEST Bellemann Elektro Service Team GmbH, Rauenberg-Malschenberg



H- AND GROOVE-PROFILES

Groove and H-profiles are offered with a comprehensive range of mounting accessories and are hard to beat in terms of versatility. The range of accessories includes cable suspensions, tension springs, sliding blocks and much more.



AU-03-12



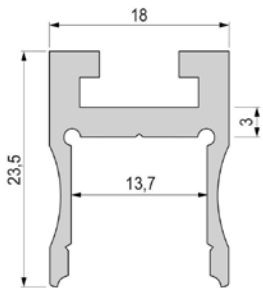

·for LED strips up to 13.3 mm wide

Housing Aluminium
Surface Anodised
Length 2000 mm

Article	Housing Color	Price
970231	<input type="checkbox"/> Silver	€ 37.95



Cover | PMMA - Polymethyl methacrylate

	Clear	Matt	Milky	
				
1 m	983020	983022	983024	€ 7.95
2 m	983021	983023	983025	€ 17.95
3 m	983028	983027	983026	€ 25.95
				
1 m	983520	983522	983524	€ 7.95
2 m	983521	983523	983525	€ 17.95
3 m	983527		983526	€ 25.95
				
1 m		984022	984024	€ 7.95
2 m		984023	984025	€ 17.95
3 m			984026	€ 25.95
				
1 m		984522	984524	€ 7.95
2 m		984523	984525	€ 17.95
3 m			984526	€ 25.95

end caps set | 2 pieces | Plastic | € 4.95

end caps set | Plastic | € 4.95

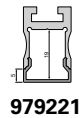
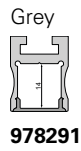

Accessories

987020 Universal sliding block/longitudinal connector, set of 2 pieces



€ 7.95

987060 Cable suspension (swivel), set of 2 pieces



€ 35.95





ET-04-12

·for LED strips up to 13.3 mm wide



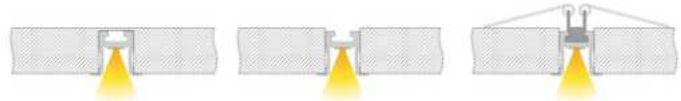
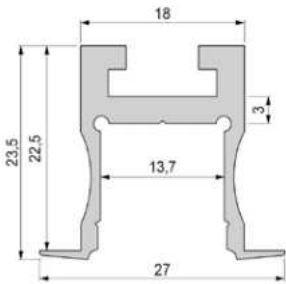

Housing Aluminium
Surface Anodised
Length 2000 mm





Article	Housing Color	Price
975231	<input type="checkbox"/> Silver	€ 39.95



Cover | PMMA - Polymethyl methacrylate

end caps set | 2 pieces | Plastic

	Clear	Matt	Milky	
				
1 m	983020	983022	983024	€ 7.95
2 m	983021	983023	983025	€ 17.95
3 m	983028	983027	983026	€ 25.95
				
1 m	983520	983522	983524	€ 7.95
2 m	983521	983523	983525	€ 17.95
3 m	983527		983526	€ 25.95
				
1 m		984022	984024	€ 7.95
2 m		984023	984025	€ 17.95
3 m			984026	€ 25.95
				
1 m		984522	984524	€ 7.95
2 m		984523	984525	€ 17.95
3 m			984526	€ 25.95

	Grey	Silver
		
		978301 € 4.95
		988021 € 21.95
		
	978721	€ 4.95
		
	979231	€ 4.95
		
	979731	€ 4.95

Accessories

988021 end caps set | 2 pieces | Aluminium



21,95 €

987020 Universal sliding block/longitudinal connector, set of 2 pieces



€ 7.95

987040 Sliding block with tensioning springs, set of 2 pieces



€ 7.95





AU-10-12

·up to 5.7 mm LED strip lights

Housing Aluminium

Article	Housing Color	Surface	Length	Price
970280	<input type="checkbox"/> Silver	Anodised	2000 mm	€ 35.95
970281	<input type="checkbox"/> Silver	Anodised	3000 mm	€ 54.95
970284	<input type="checkbox"/> White	Varnished	2000 mm	€ 35.95
970285	<input type="checkbox"/> White	Varnished	3000 mm	€ 54.95

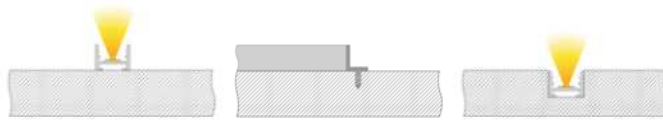
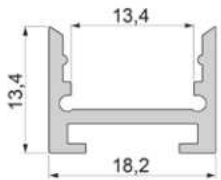

Cover | Polycarbonate
Milky



- 2 m **983090** € 23.95
- 3 m **983091** € 35.95

Accessories

- 987025** Sliding block/longitudinal connector
- 987026** Sliding block/corner connector 120°
- 987027** Sliding block/corner connector 90°



- € 9.95
- € 9.95
- € 9.95

Accessories for **970280, 970281, 970284**

- 980023** Mounting clip, set (2 pieces)



€ 4.95

Accessories for **970285**

- 980020** End cap P-AU-10-12, set of 2 pieces
- 980021** End cap, set of 2 pieces



- € 19.95
- € 19.95







STEP-, SOCKET-, ANGLE-, CORNER-PROFILES



The perfect light is not always planned from the very start. With the mounting and corner profiles, you can also integrate linear light at a later stage.



AL-01-10

·for LED strips up to 11.3 mm wide

Housing Aluminium
Surface Anodised

Article	Housing Color	Length	Price
970503	 Silver	2000 mm	€ 59.95
970502	 Silver	3000 mm	€ 94.95

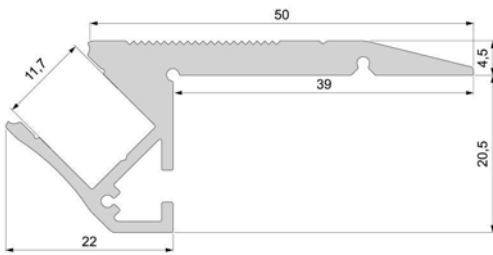

Cover | PMMA - Polymethyl methacrylate

Cover | Polycarbonate* | walkable

Clear Matt Milky



1 m	983010	983012	983014	€ 7.95
1 m			983080*	€ 11.5
2 m	983011	983013	983015	€ 17.95
2 m			983081*	€ 21.95
3 m	983016	983017	983018	€ 25.95
3 m			983082*	€ 32.95
4 m	983060	983061	983062	€ 33.95

end caps set | 2 pieces (left/right) | Plastic | € 4.95

Grey

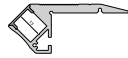

978191

Accessories

930105 Mounting adhesive 310ml



€ 35.95





AL-02-10

·for LED strips up to 11.3 mm wide

Housing Aluminium
Surface Anodised

Article	Housing Color	Length	Price
970520	<input type="checkbox"/> Silver	1000 mm	€ 30.95
970523	<input type="checkbox"/> Silver	2000 mm	€ 59.95
970522	<input type="checkbox"/> Silver	3000 mm	€ 94.95

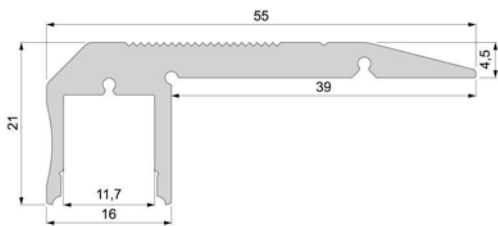

Cover | PMMA - Polymethyl methacrylate

Clear Matt Milky



1 m	983010	983012	983014	€ 7.95
2 m	983011	983013	983015	€ 17.95
3 m	983016	983017	983018	€ 25.95
4 m	983060	983061	983062	€ 33.95

end caps set | 2 pieces (left/right) | Plastic | € 4.95

Grey

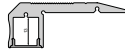

978201

Accessories

930105 Mounting adhesive 310ml



€ 35.95





AV-01-20

·for LED strips up to 22 mm wide

Housing Aluminium
Length 2000 mm

Article	Housing Color	Price
970460	 Silver	€ 35.95

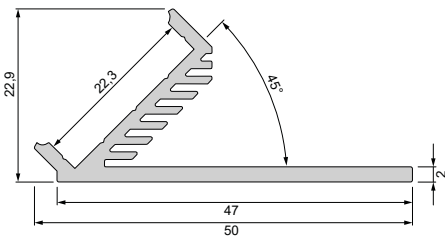
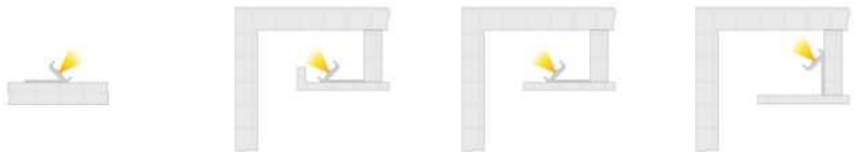

Cover | PMMA - Polymethyl methacrylate

Clear Milky

			
1 m	983040	983044	€ 11.5
2 m	983041	983045	€ 21.95
3 m		983046	€ 32.95



			
1 m		984044	€ 11.5
2 m		984045	€ 21.95

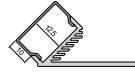

			
1 m		984544	€ 11.5
2 m		984545	€ 21.95



Accessories

930105 Mounting adhesive 310ml



€ 35.95





AV-02-20

·for LED strips up to 22 mm wide





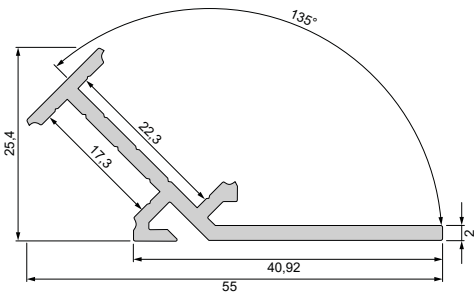

Housing Aluminium
Length 2000 mm

Article	Housing Color	Price
970470	 Silver	€ 35.95

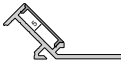

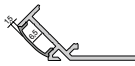
Cover | PMMA - Polymethyl methacrylate

Clear Matt Milky

				
1 m	983040	983044	€ 11.5	
2 m	983041	983045	€ 21.95	
3 m		983046	€ 32.95	
				
3 m		983539	€ 28.95	
				
1 m		984044	€ 11.5	
2 m		984045	€ 21.95	
				
1 m		984544	€ 11.5	
2 m		984545	€ 21.95	

Accessories

930105 Mounting adhesive 310ml



€ 35.95





AM-01-10

·for LED strips up to 11.3 mm wide

Housing Aluminium

Article	Housing Color	Surface	Length	Price
970305	White		2000 mm	€ 37.95
970301	Silver	Anodised	2000 mm	€ 37.95
970308	Silver	Anodised	3000 mm	€ 59.95
970303	Black	Brushed	2000 mm	€ 37.95

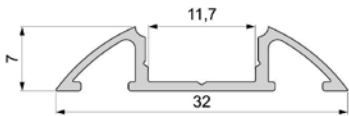

Cover | PMMA - Polymethyl methacrylate

Clear Matt Milky

end caps set | 2 pieces | Plastic | € 4.95

White Grey Black



1 m	983010	983012	983014	€ 7.95
2 m	983011	983013	983015	€ 17.95
3 m	983016	983017	983018	€ 25.95
4 m	983060	983061	983062	€ 33.95



1 m	983510	983512	983514	€ 7.95
2 m	983511	983513	983515	€ 17.95
3 m	983516	983517	983518	€ 25.95
4 m	983560	983561	983562	€ 33.95

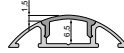

978700 978701 978702

Accessories

930105 Mounting adhesive 310ml



€ 35.95







AM-02-10

·for LED strips up to 11.3 mm wide

Housing Aluminium

Article	Housing Color	Surface	Length	Price
970602	 Silver	Anodised	2000 mm	€ 82.95
970600	 Silver	Anodised	3000 mm	€ 124.95
970601	 Black	Brushed	3000 mm	€ 124.95

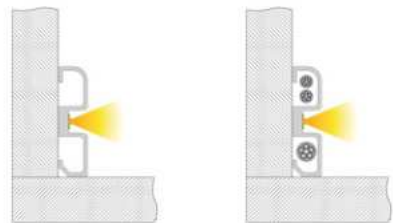
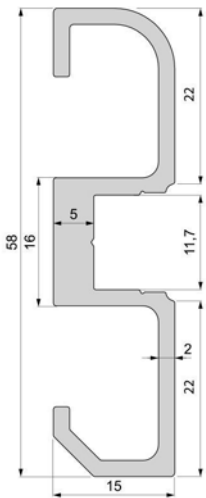

Cover | PMMA - Polymethyl methacrylate

Clear Matt Milky



1 m	983010	983012	983014	€ 7.95
2 m	983011	983013	983015	€ 17.95
3 m	983016	983017	983018	€ 25.95
4 m	983060	983061	983062	€ 33.95



1 m	983510	983512	983514	€ 7.95
2 m	983511	983513	983515	€ 17.95
3 m	983516	983517	983518	€ 25.95
4 m	983560	983561	983562	€ 33.95



1 m	984012	984014	€ 7.95
2 m	984013	984015	€ 17.95
3 m	984017	984018	€ 25.95
4 m	984010	984011	€ 33.95

end caps set | 2 pieces (left/right) | Plastic

Grey Black



978241	€ 4.95
978242	-





AV-03-12

·for LED strips up to 13.3 mm wide

Housing Aluminium
Surface Anodised

Article	Housing Color	Length	Price
970433	<input checked="" type="checkbox"/> Silver	2000 mm	€ 37.95
970437	<input type="checkbox"/> White	2000 mm	€ 37.95
970431	<input checked="" type="checkbox"/> Silver	2500 mm	€ 46.95
970434	<input checked="" type="checkbox"/> Silver	3000 mm	€ 59.95
970438	<input type="checkbox"/> White	3000 mm	€ 59.95

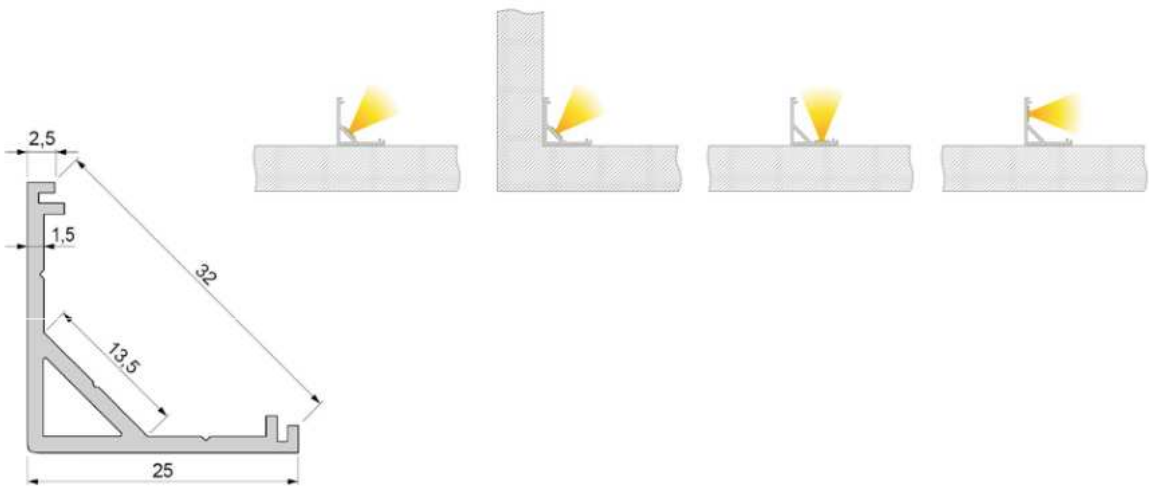

Cover | PMMA - Polymethyl methacrylate
Milky



2 m **984565** € 21.95
3 m **984568** € 32.95

end caps set | 2 pieces | Plastic | € 4.95

Grey



979751

Accessories

930105 Mounting adhesive 310ml

€ 35.95

930348 3M doublesided tape 50000x15x0,2mm



€ 38.95





AV-01-10

·for LED strips up to 11.3 mm wide

Housing Aluminium

Article	Housing Color	Surface	Length	Price
970403	<input type="checkbox"/> White		2000 mm	€ 35.95
970401	<input checked="" type="checkbox"/> Silver	Anodised	2000 mm	€ 35.95
970404	<input checked="" type="checkbox"/> Silver	Anodised	3000 mm	€ 54.95

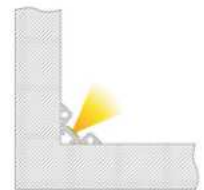
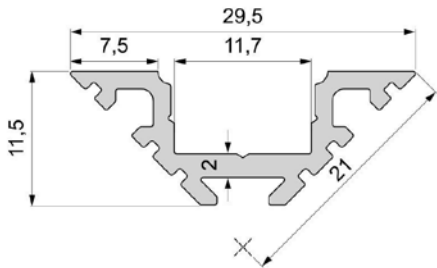



Cover | PMMA - Polymethyl methacrylate

Clear Matt Milky

				
1 m	983010	983012	983014	€ 7.95
2 m	983011	983013	983015	€ 17.95
3 m	983016	983017	983018	€ 25.95
4 m	983060	983061	983062	€ 33.95

				
1 m	983510	983512	983514	€ 7.95
2 m	983511	983513	983515	€ 17.95
3 m	983516	983517	983518	€ 25.95
4 m	983560	983561	983562	€ 33.95

				
1 m		984012	984014	€ 7.95
2 m		984013	984015	€ 17.95
3 m		984017	984018	€ 25.95
4 m		984010	984011	€ 33.95

				
1 m		984512	984514	€ 7.95
2 m		984513	984515	€ 17.95
3 m		984517	984518	€ 25.95
4 m		984510	984511	€ 33.95

				
1 m	985010			€ 7.95
2 m	985011			€ 17.95
3 m	985016			€ 25.95

end caps set | 2 pieces | Plastic | € 4.95

White Grey

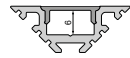

978170 978171

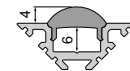
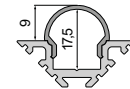
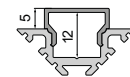
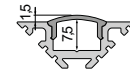

Accessories

930105 Mounting adhesive 310ml

930348 3M doublesided tape 50000x15x0,2mm



€ 35.95

€ 38.95



EV-04-12

·for LED strips up to 13.3 mm wide

Housing Aluminium
Surface Anodised

Article	Housing Color	Length	Price
975411	<input type="checkbox"/> Silver	2000 mm	€ 39.95
975412	<input type="checkbox"/> Silver	3000 mm	€ 61.95

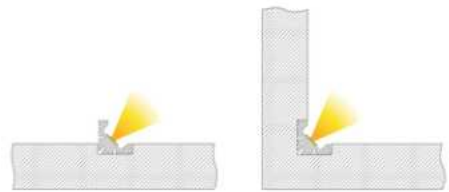
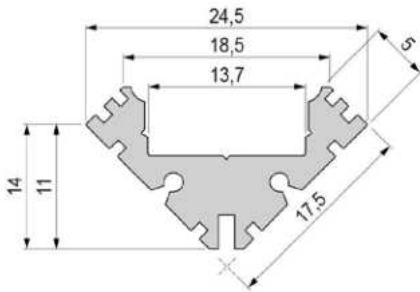

Cover | PMMA - Polymethyl methacrylate

Clear Matt Milky

end caps set | Plastic | € 4.95

Grey

					
1 m	983020	983022	983024	€ 7.95	
2 m	983021	983023	983025	€ 17.95	
3 m	983028	983027	983026	€ 25.95	

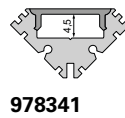

					
1 m	983520	983522	983524	€ 7.95	
2 m	983521	983523	983525	€ 17.95	
3 m	983527		983526	€ 25.95	

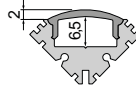

					
1 m		984022	984024	€ 7.95	
2 m		984023	984025	€ 17.95	
3 m			984026	€ 25.95	

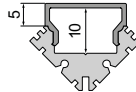

					
1 m		984522	984524	€ 7.95	
2 m		984523	984525	€ 17.95	
3 m			984526	€ 25.95	

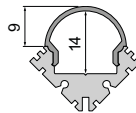

Accessories

930105 Mounting adhesive 310ml



€ 35.95

987006 Set of 2 retaining clips for AU-12



€ 3.95

987080 Universal holding clip mount (swivel) set of 2 pieces



€ 23.95





AV-05-12

·for LED strips up to 12 mm wide

Housing Aluminium
Surface Anodised

Article	Housing Color	Length	Price
970550	 Silver	2000 mm	€ 39.95
970551	 Silver	3000 mm	€ 59.95

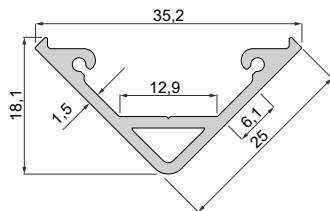

Cover | Polycarbonate

Milky



2 m **983100** € 23.95

3 m **983101** € 35.95



2 m **984570** € 23.95

3 m **984571** € 35.95

2 m **985570** € 23.95

3 m **985571** € 35.95

end caps set | 2 pieces

1x installation material | Aluminium | € 21.95

Silver

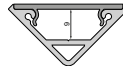

978370

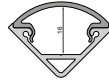

979760



980550





AV-05-15

·for LED strips up to 15 mm wide

Housing Aluminium
Surface Anodised

Article	Housing Color	Length	Price
970560	 Silver	2000 mm	€ 49.95
970561	 Silver	3000 mm	€ 79.95

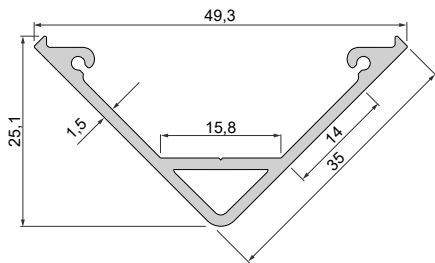

Cover | Polycarbonate

Milky



2 m **983110** € 30.95

3 m **983111** € 44.95



2 m **984580** € 30.95

3 m **984581** € 44.95



2 m **985580** € 30.95

3 m **985581** € 44.95

end caps set | 2 pieces
1x installation material | Aluminium

Silver

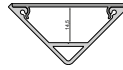

978380 € 24.95

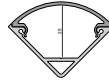

979770 € 21.95



980560 € 21.95





AV-05-25

·for LED strips up to 25 mm or 2x 12 mm wide

Housing Aluminium
Surface Anodised

Article	Housing Color	Length	Price
970570	 Silver	2000 mm	€ 69.95
970571	 Silver	3000 mm	€ 99.95

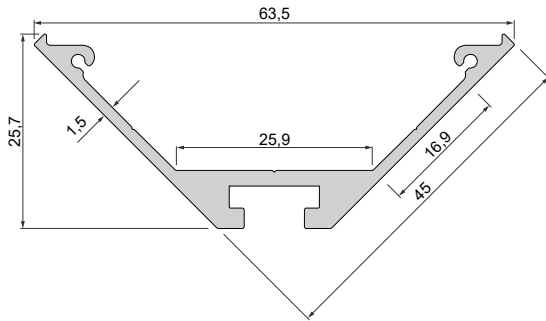

Cover | Polycarbonate

Milky



2 m **983120** € 35.95

3 m **983121** € 54.95



2 m **984590** € 35.95

3 m **984591** € 54.95



2 m **985590** € 35.95

3 m **985591** € 54.95

end caps set | 2 pieces
1x installation material | Aluminium

Silver

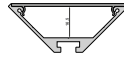

978390 € 24.95

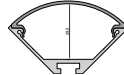

979780 € 21.95



980570 € 21.95



Foto: Daniel Wieser . Architektur fotografie, Karlsruhe



With the kind support of BEST Belermann Elektro Service Team GmbH, Rauenberg-Malschenberg



DRY CONSTRUCTION PROFILES

Our dry construction profiles offer you full creative freedom. Redefine linear light – whether as a primary light or for accent lighting.



EL-02-12

·14 mm LED strip lights

Housing Aluminium

Article	Housing Color	Surface	Length	Price
975495	<input type="checkbox"/> White		2000 mm	€ 82.95
975491	<input checked="" type="checkbox"/> Silver	Anodised	2000 mm	€ 82.95
975496	<input checked="" type="checkbox"/> Silver	Anodised	3000 mm	€ 124.95

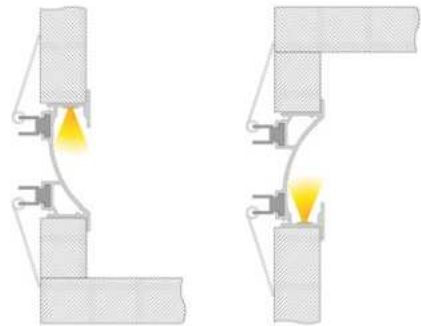
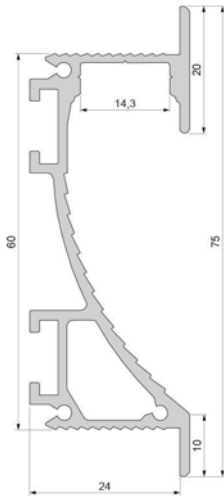

Cover | PMMA - Polymethyl methacrylate

end caps set | 2 pieces (left/right)
1x installation material | Plastic

Clear Matt Milky

White Grey



1 m	983020	983022	983024	€ 7.95
2 m	983021	983023	983025	€ 17.95
3 m	983028	983027	983026	€ 25.95

978250	978251	€ 4.95
---------------	---------------	---------------

Accessories

930105 Mounting adhesive 310ml

930346 3M doublesided tape 50000x10x0,2mm

978252 end caps set | 2 pieces (left/right) | 1x installation material | Aluminium

987020 Universal sliding block/longitudinal connector, set of 2 pieces

987040 Sliding block with tensioning springs, set of 2 pieces





ET-03-10



·12 mm LED strips lights

Housing Aluminium

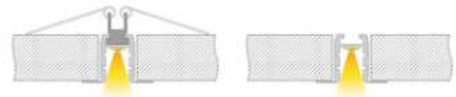
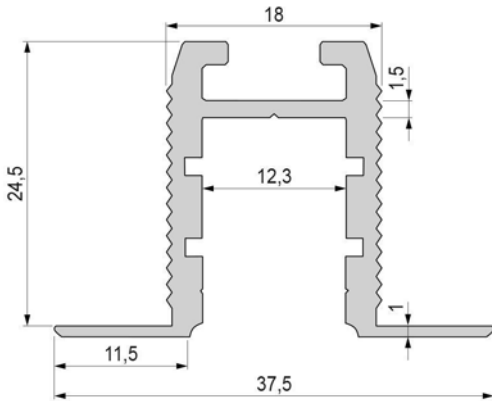
Article	Housing Color	Surface	Length	Price
975475	<input type="checkbox"/> White		2500 mm	€ 59.95
975471	<input checked="" type="checkbox"/> Silver	Anodised	2500 mm	€ 59.95
975476	<input checked="" type="checkbox"/> Silver	Anodised	3000 mm	€ 75.95



Cover | PMMA - Polymethyl methacrylate

	Clear	Matt	Milky	
				
1 m	983010	983012	983014	€ 7.95
2 m	983011	983013	983015	€ 17.95
3 m	983016	983017	983018	€ 25.95
4 m	983060	983061	983062	€ 33.95
				
1 m		984012	984014	€ 7.95
2 m		984013	984015	€ 17.95
3 m		984017	984018	€ 25.95
4 m		984010	984011	€ 33.95
				
1 m		984512	984514	€ 7.95
2 m		984513	984515	€ 17.95
3 m		984517	984518	€ 25.95
4 m		984510	984511	€ 33.95

end caps set | 2 pieces | Plastic | € 4.95

end caps set | Plastic | € 4.95

White Grey

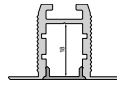

978260 **978261**

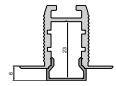

979200 **979201**

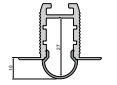

979700 **979701**

Accessories

930105 Mounting adhesive 310ml

970762 Carrier profile, LED-profile T-01-10

987020 Universal sliding block/longitudinal connector, set of 2 pieces

987040 Sliding block with tensioning springs, set of 2 pieces



€ 35.95

€ 7.95

€ 7.95

€ 7.95





EL-03-10



·12 mm LED strips lights

Housing Aluminium

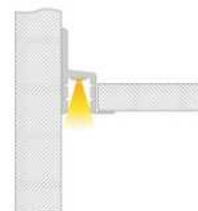
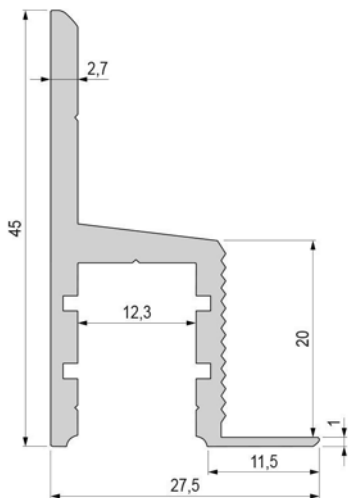
Article	Housing Color	Surface	Length	Price
975485	<input type="checkbox"/> White		2500 mm	€ 79.95
975483	<input checked="" type="checkbox"/> Silver	Anodised	2000 mm	€ 59.95
975486	<input checked="" type="checkbox"/> Silver	Anodised	3000 mm	€ 94.95





Cover | PMMA - Polymethyl methacrylate

	Clear	Matt	Milky	
				
1 m	983010	983012	983014	€ 7.95
2 m	983011	983013	983015	€ 17.95
3 m	983016	983017	983018	€ 25.95
4 m	983060	983061	983062	€ 33.95
				
1 m		984012	984014	€ 7.95
2 m		984013	984015	€ 17.95
3 m		984017	984018	€ 25.95
4 m		984010	984011	€ 33.95
				
1 m		984512	984514	€ 7.95
2 m		984513	984515	€ 17.95
3 m		984517	984518	€ 25.95
4 m		984510	984511	€ 33.95

end caps set | 2 pieces (left/right) | Plastic | € 4.95

end caps set | Plastic | € 4.95

White	Grey
	
978270	978271

	
979210	979211

	
979710	979711

Accessories for **975483, 975485, 975486**

970762 Carrier profile, LED-profile T-01-10



€ 7.95





EL-04-12

·14 mm LED strip lights

Housing Aluminium
 Surface Natural
 Length 3000 mm

Article	Housing Color	Price
975530	 Silver	€ 99.95

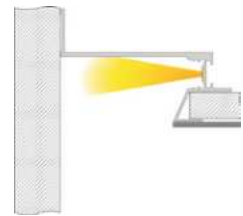
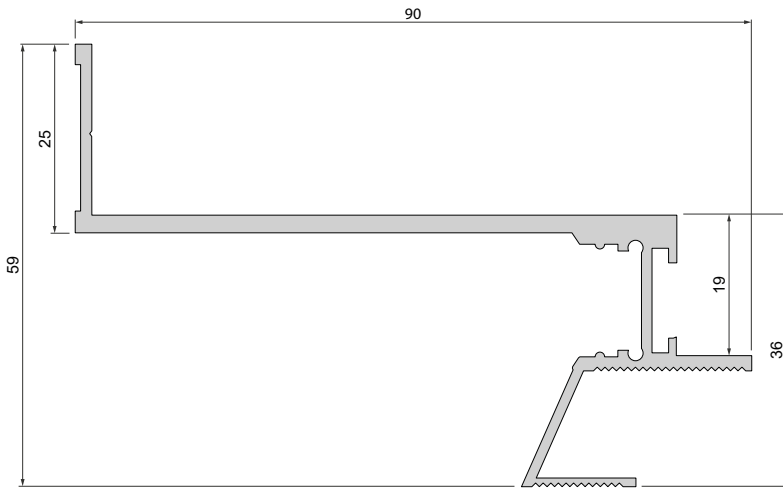

Cover | Polycarbonate
 Milky



2 m	983090	€ 23.95
3 m	983091	€ 35.95





EU-01-36

·Up to 36 mm LED strip light

Housing Aluminium
 Surface Natural
 Length 3000 mm

Article	Housing Color	Price
975501	■ Silver	€ 124.95

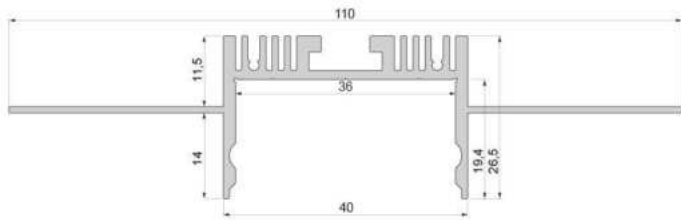

Cover | PMMA - Polymethyl methacrylate

Milky



3 m **985601** € 42.95

end caps set | 2 pieces

1x installation material | Aluminium | € 21.95

Grey

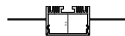

978175 € 21.95

Accessories

985605 Dummy cover



€ 30.95





EU-02-36

·for LED strips up to 36 mm wide

Housing Aluminium
 Surface Natural
 Length 3000 mm

Article	Housing Color	Price
975525	■ Silver	€ 129.95

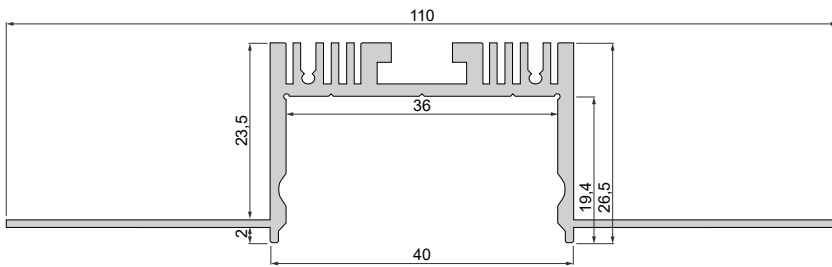

Cover | PMMA - Polymethyl methacrylate
 Milky



3 m **985601 € 42.95**

Accessories

985605 Dummy cover



€ 30.95



Lighting design

Interested in our lighting design service?

Your contact person will be happy to answer any questions you may have.



EU-10-12

·for LED strips up to 12 mm wide

Housing	Aluminium
Surface	Natural
Length	3000 mm

Article	Housing Color	Price
975511	<input type="checkbox"/> Silver	€ 59.95

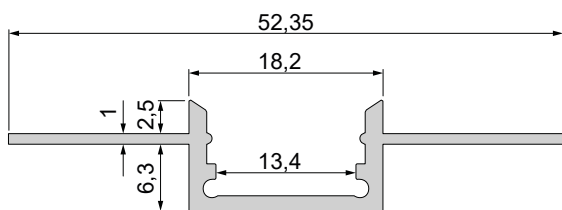

Cover | Polycarbonate
Milky



2 m	983090	€ 23.95
3 m	983091	€ 35.95





EV-11-12

·for LED strips up to 12 mm wide

Housing	Aluminium
Surface	Natural
Length	3000 mm

Article	Housing Color	Price
975516	 Silver	€ 69.95

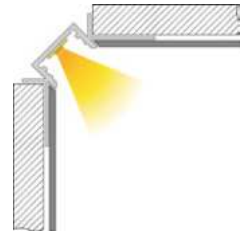
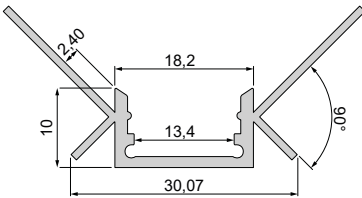

Cover | Polycarbonate
Milky



2 m	983090	€ 23.95
3 m	983091	€ 35.95





EV-12-12

·for LED strips up to 12 mm wide

Housing	Aluminium
Surface	Natural
Length	3000 mm

Article	Housing Color	Price
975521	 Silver	€ 59.95

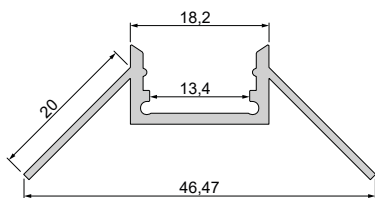

Cover | Polycarbonate
Milky



2 m	983090	€ 23.95
3 m	983091	€ 35.95

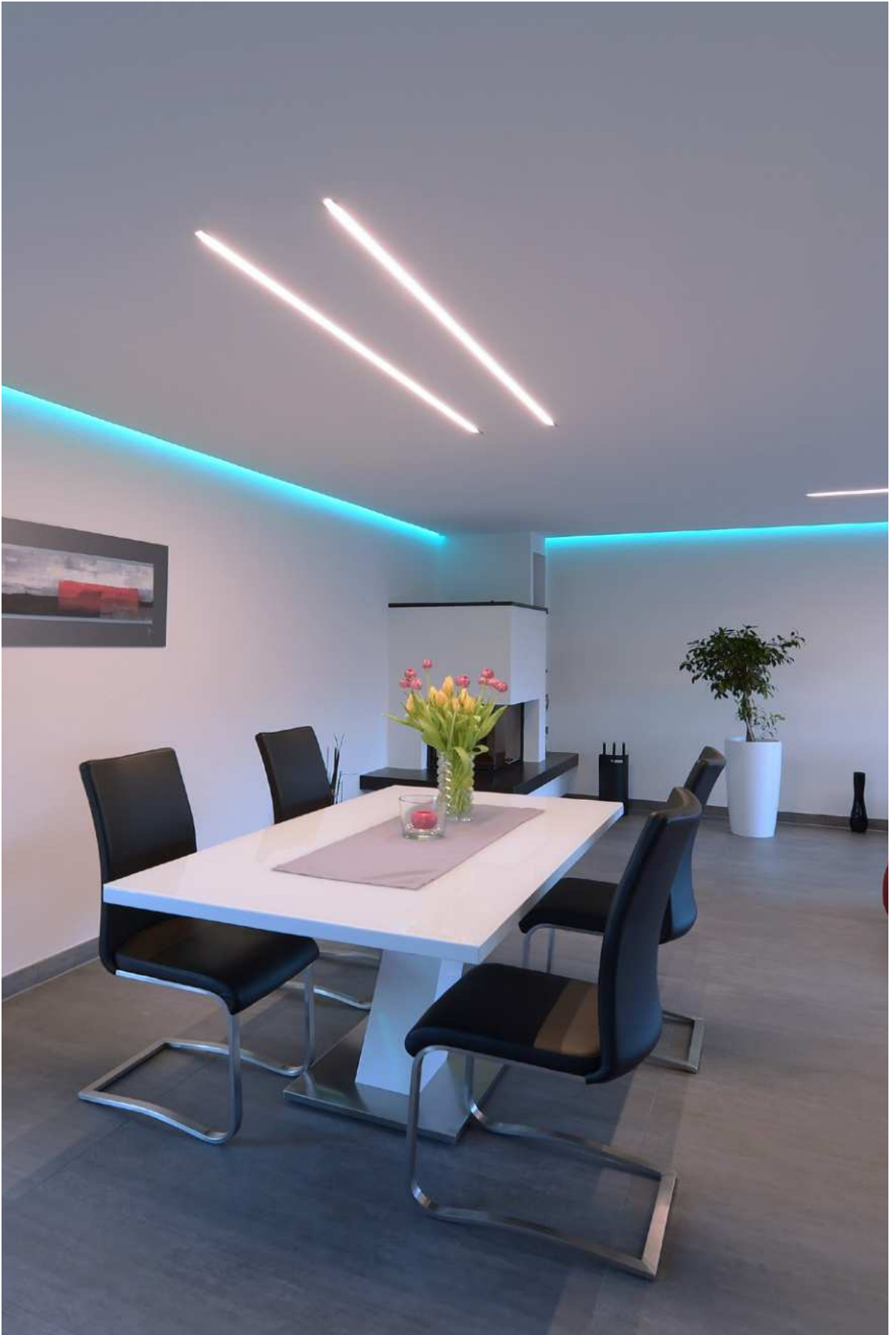



With the kind support of BEST Bellemann Elektro Service Team GmbH, Rauenberg-Malschenberg



TILE PROFILES



Tile profiles play to every corner and closing area. Do away with conventional tile end profiles and set a new standard with linear light.



EL-01-08

·for LED strips up to 9.3 mm wide

Housing Aluminium
Surface Anodised

Article	Housing Color	Length	Price
975331	 Silver	2500 mm	€ 53.95
975334	 Silver	3000 mm	€ 64.95

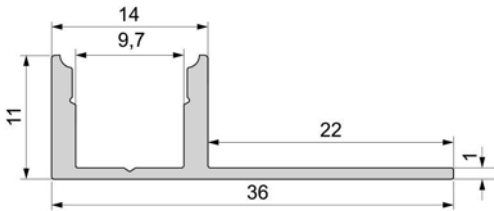
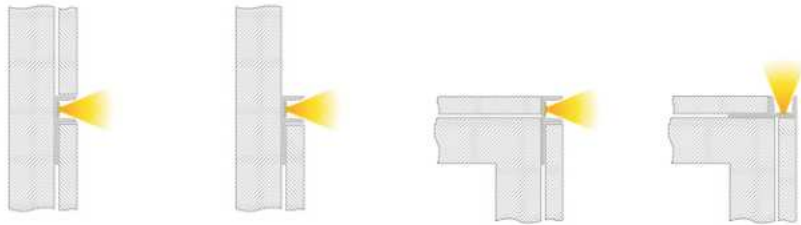

Cover | PMMA - Polymethyl methacrylate
Clear Matt Milky



1 m	983000	983002	983004	€ 7.95
2 m	983001	983003	983005	€ 17.95
3 m	983006	983007	983008	€ 25.95

end caps set | 2 pieces | Plastic | € 4.95
Grey



978211







EL-03-12

·for LED strips up to 13.3 mm wide

Housing Aluminium

Article	Housing Color	Surface	Length	Price
975360	 Silver	Anodised	1250 mm	€ 28.95
975361	 Silver	Anodised	2500 mm	€ 59.95
975365	 White	Varnished	2500 mm	€ 59.95

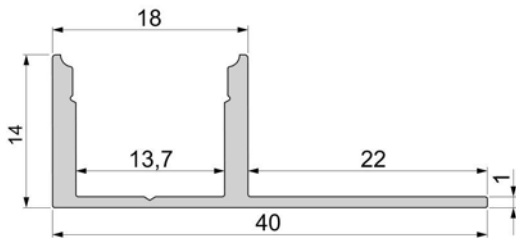
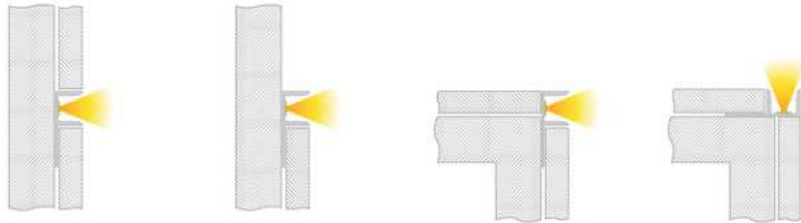

Cover | PMMA - Polymethyl methacrylate

Clear Matt Milky



1 m	983020	983022	983024	€ 7.95
2 m	983021	983023	983025	€ 17.95
3 m	983028	983027	983026	€ 25.95



1 m	984022	984024	€ 7.95
2 m	984023	984025	€ 17.95
3 m	984026	€ 25.95	









EA-03-12

·Up to 12 mm LED strip light

Housing Aluminium

Article	Housing Color	Surface	Length	Price
975390	 Silver	Anodised	2000 mm	€ 38.95
975391	 Silver	Anodised	3000 mm	€ 59.95
975394	 White	Varnished	2000 mm	€ 38.95
975395	 White	Varnished	3000 mm	€ 59.95

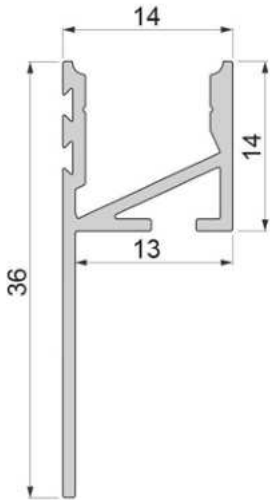

Cover | PMMA - Polymethyl methacrylate

Clear Matt Milky



1 m	983000	983002	983004	€ 7.95
2 m	983001	983003	983005	€ 17.95
3 m	983006	983007	983008	€ 25.95



1 m	984002	984004	€ 7.95
2 m	984003	984005	€ 17.95

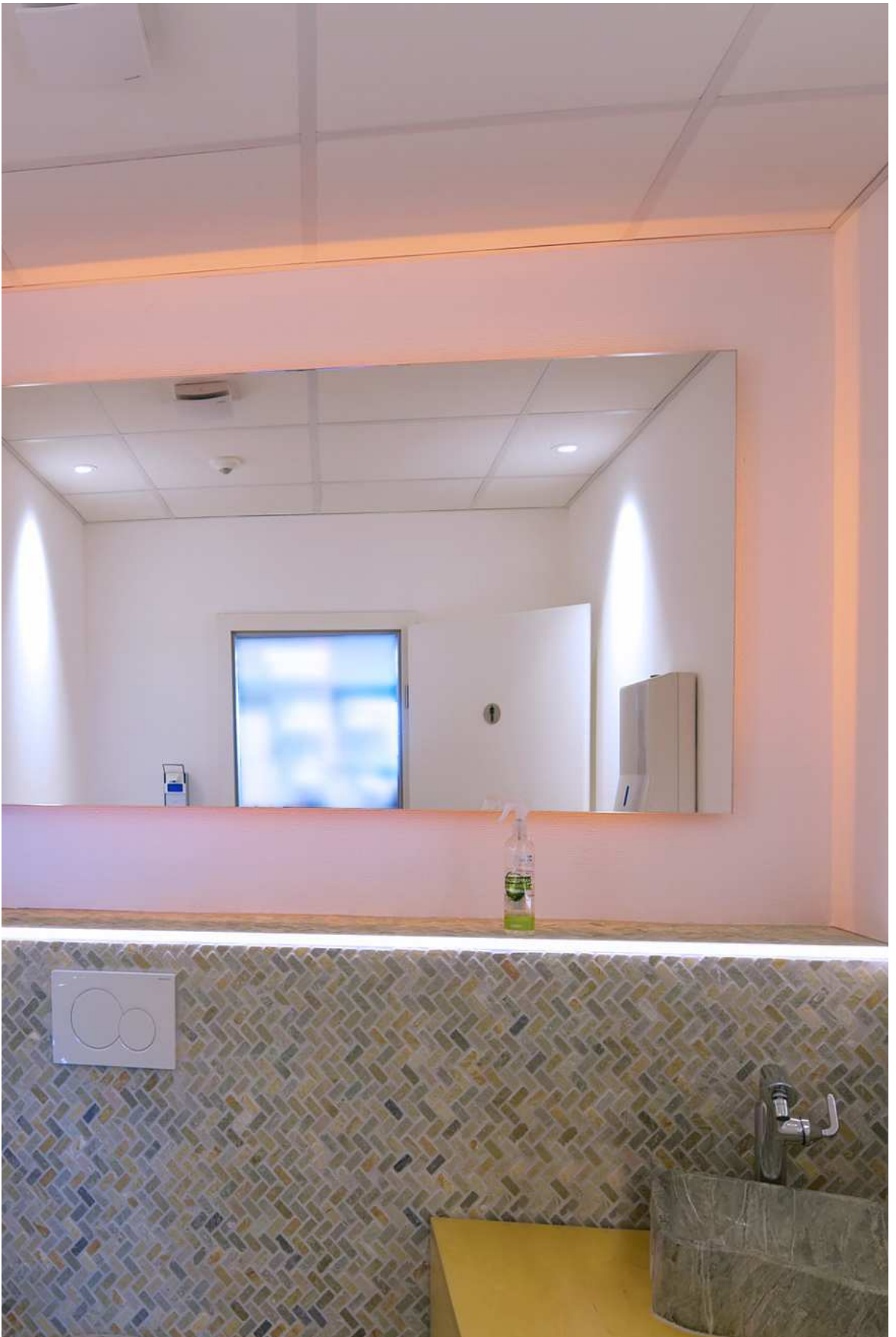





EV-01-08

·for LED strips up to 9.3 mm wide

Housing Aluminium
Surface Anodised

Article	Housing Color	Length	Price
975341	 Silver	2500 mm	€ 79.95
975344	 Silver	3000 mm	€ 99.95

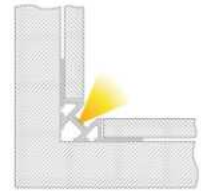
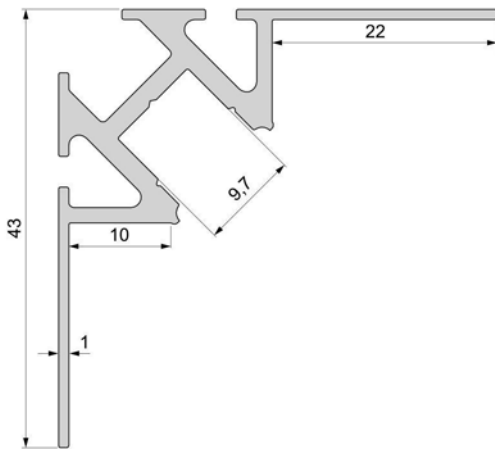

Cover | PMMA - Polymethyl methacrylate

Clear Matt Milky



1 m	983000	983002	983004	€ 7.95
2 m	983001	983003	983005	€ 17.95
3 m	983006	983007	983008	€ 25.95



1 m		985504	€ 7.95
2 m		985505	€ 17.95
3 m		985508	€ 25.95

end caps set | 2 pieces | Plastic | € 4.95

Grey



978221



980501







EV-01-12

·for LED strips up to 13.3 mm wide

Housing Aluminium
Length 2500 mm

Article	Housing Color	Surface	Price
975371	 Silver	Anodised	€ 99.95
975375	 White	Varnished	€ 99.95

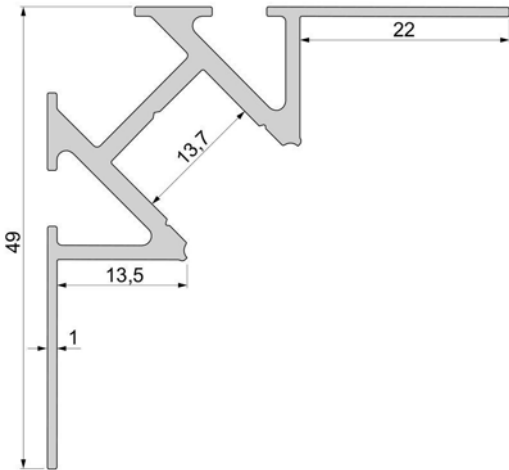

Cover | PMMA - Polymethyl methacrylate

Clear Matt Milky



1 m	983020	983022	983024	€ 7.95
2 m	983021	983023	983025	€ 17.95
3 m	983028	983027	983026	€ 25.95







EV-02-08

·for LED strips up to 9.3 mm wide

Housing Aluminium
Surface Anodised

Article	Housing Color	Length	Price
975351	 Silver	2500 mm	€ 79.95
975353	 Silver	3000 mm	€ 99.95

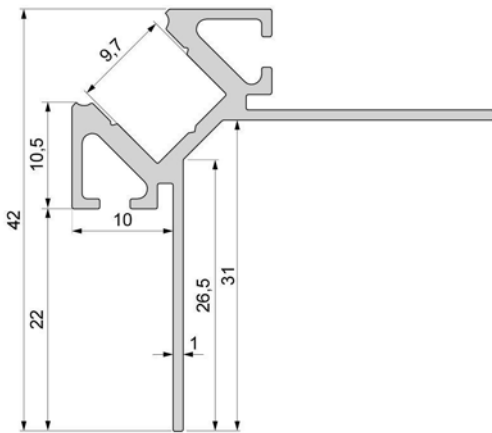

Cover | PMMA - Polymethyl methacrylate

Clear Matt Milky



1 m	983000	983002	983004	€ 7.95
2 m	983001	983003	983005	€ 17.95
3 m	983006	983007	983008	€ 25.95



1 m		985504	€ 7.95
2 m		985505	€ 17.95
3 m		985508	€ 25.95

end caps set | 2 pieces | Plastic | € 4.95

Grey



978231



980511







EV-02-12

·for LED strips up to 13.3 mm wide

Housing Aluminium
Length 2500 mm

Article	Housing Color	Surface	Price
975381	 Silver	Anodised	€ 99.95
975385	 White	Varnished	€ 99.95

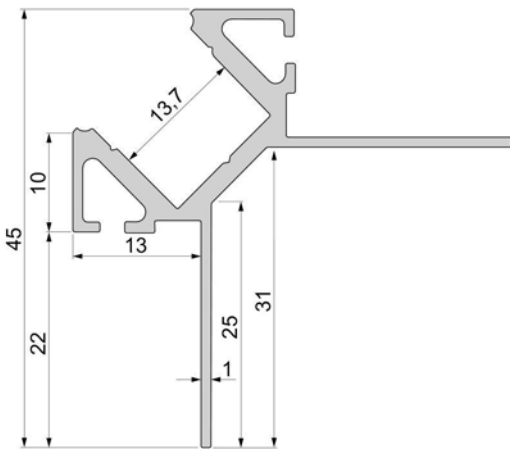

Cover | PMMA - Polymethyl methacrylate

Clear Matt Milky



1 m	983020	983022	983024	€ 7.95
2 m	983021	983023	983025	€ 17.95
3 m	983028	983027	983026	€ 25.95





With the kind support of BEST Bellemann Elektro Service Team GmbH, Rauenberg-Malschenberg



PROFILES FOR OUTDOOR USE



Outdoor areas have different requirements than indoor areas. Our IP profiles are walkable and passable and inspire as a highlight in any outdoor design.



AU-04-12

·for LED strips up to 13.3 mm wide

Housing Aluminium
Surface Anodised

Article	Housing Color	Length	Price
970723	 Silver	2000 mm	€ 23.95
970724	 Silver	3000 mm	€ 35.95

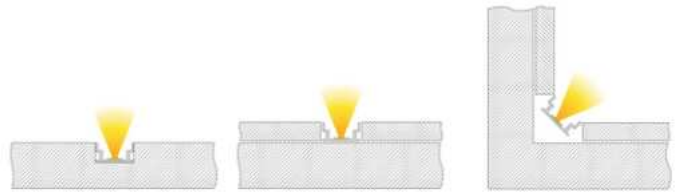
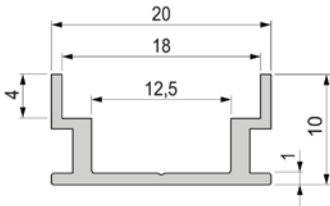

Onlineshop

You can find more information about the products in the onlineshop:
Detailed images, videos, project reports, LDT files, EPREL data sheets and more.

Cover | PMMA - Polymethyl methacrylate
Milky



2 m **988025** € 19.95
3 m **988028** € 28.95

end caps set | 2 pieces (left/right) | Plastic | € 4.95
Grey

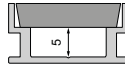

981001

Accessories

930103 Sealant smoothing agent 400ml



€ 39.95

930104 Natural stone sealant 310ml

€ 39.95





ET-05-12

·for LED strips up to 13.3 mm wide

Housing Aluminium
Surface Anodised
Length 3000 mm

Article	Housing Color	Price
975724	 Silver	€ 35.95

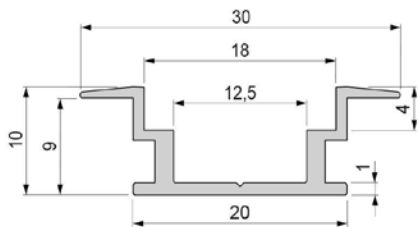

Cover | PMMA - Polymethyl methacrylate
Milky



2 m **988025** € 19.95
3 m **988028** € 28.95

end caps set | 2 pieces (left/right) | Plastic | € 4.95
Grey



981011 € 4.95

Accessories

930103 Sealant smoothing agent 400ml



€ 39.95

930104 Natural stone sealant 310ml

€ 39.95





AU-05-15

·for LED strips up to 16.3 mm wide

Housing	Aluminium
Surface	Natural
Length	2000 mm

Article	Housing Color	Price
970741	<input type="checkbox"/> Silver	€ 42.95

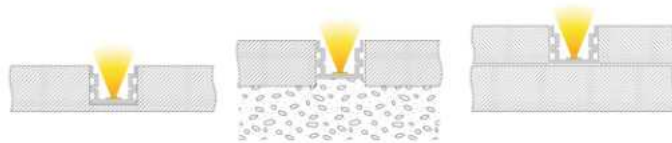
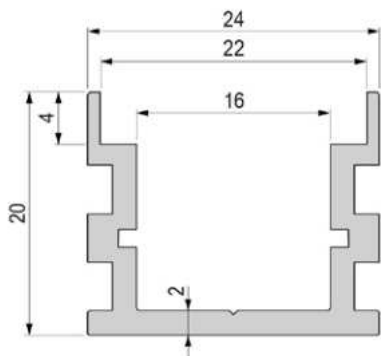

Cover | PMMA - Polymethyl methacrylate
Milky



1 m **988084** € 11.5
2 m **988085** € 21.95

end caps set | 2 pieces (left/right) | Plastic | € 4.95

Grey



981031 € 4.95

Accessories

930103 Sealant smoothing agent 400ml

930104 Natural stone sealant 310ml

970764 Carrier profile, LED-profile T-01-15



€ 39.95

€ 39.95

€ 7.95

With the kind support of LED-TEC, Giran/Italien | Foto: fotoeichhorn





ET-05-15

·for LED strips up to 16.3 mm wide

Housing Aluminium
Surface Anodised
Length 2000 mm

Article	Housing Color	Price
975741	 Silver	€ 42.95

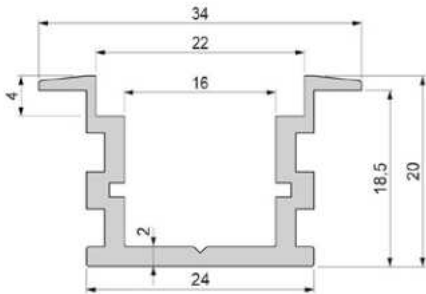

Cover | PMMA - Polymethyl methacrylate
Milky



1 m **988084** € 11.5
2 m **988085** € 21.95

end caps set | 2 pieces (left/right) | Plastic | € 4.95

Grey

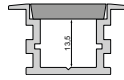

981041 € 4.95

Accessories

930103 Sealant smoothing agent 400ml

930104 Natural stone sealant 310ml

970764 Carrier profile, LED-profile T-01-15



€ 39.95

€ 39.95

€ 7.95





EU-01-12

·for LED strips up to 13.3 mm wide

Housing	Aluminium
Surface	Anodised
Length	2000 mm

Article	Housing Color	Price
975781	 Silver	€ 79.95

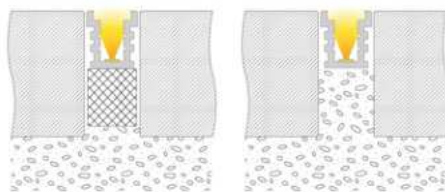
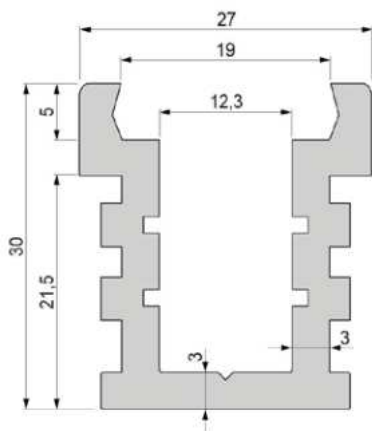

Accessories

Cables, plugs, clamps and more:

You can find the right mounting accessories in the »Accessories« section.

Cover | PMMA - Polymethyl methacrylate
Milky



1 m **988054** € 11.5
2 m **988055** € 21.95

end caps set | 2 pieces (left/right) | Plastic | € 4.95

Grey



981021 € 4.95

Accessories

930103 Sealant smoothing agent 400ml

930104 Natural stone sealant 310ml

970762 Carrier profile, LED-profile T-01-10

990109 Foam underlay



€ 39.95



€ 39.95



€ 7.95

€ 7.95





LED STRIPES

- 708 LED stripes | overview
- 710 technical information
- 712 COB
- 722 12V
- 726 24V
- 758 48V
- 764 230V



page 712



page 722



page 726



page 758



page 764

led stripes



THINGS TO KNOW ABOUT LED STRIPES

Which LED chips and sizes are most commonly installed in our company?

On these two pages, we focus on LED stripes, or more precisely on the LED chips installed on them. These are installed in a wide variety of sizes, power classes, quantities and distances for a wide variety of stripes in 12V, 24V, 48V and 230V.

quality promise

Our LED stripes are subjected to constant quality control during production. Thus, we can guarantee the high quality of our LED stripes.

STRUCTURE OF A STANDARD LED CHIP

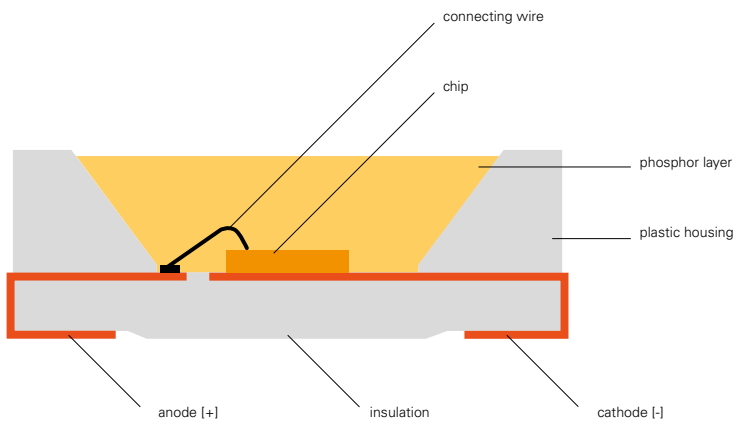

WHAT DO THE NUMBERS MEAN FOR A LED STRIPE?

The numbers clearly indicate the size [width and length] and shape of the LED chips installed on a carrier [stripe]. For example, the LED chip 5050 – one of the world's most

frequently used LED chips – has a width of LED chips – each with a length and width of 5 mm. A 2835 LED chip therefore has a width of 2.8 mm and a length of 3.5 mm.

SMD 5050 | single
chip dimensions: 5 x 5 mm



SMD 2835 | single
chip dimensions: 2,8 x 3,5 mm

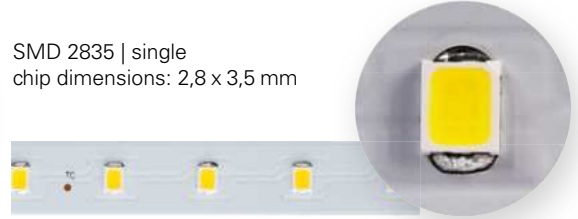

SMD 5050 | RGB
chip dimensions: 5 x 5 mm

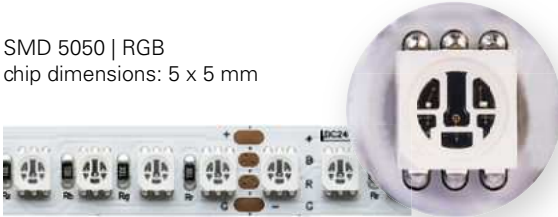

SMD 2835 | WW / CW
chip dimensions: 2,8 x 3,5 mm



SMD 5050 | WW / CW
chip dimensions: 5 x 5 mm



SMD 2216 | single
chip dimensions: 1,6 x 2,2 mm

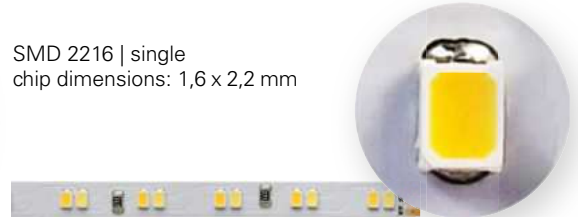

SMD 3528 | single
chip dimensions: 2,8 x 3,5 mm

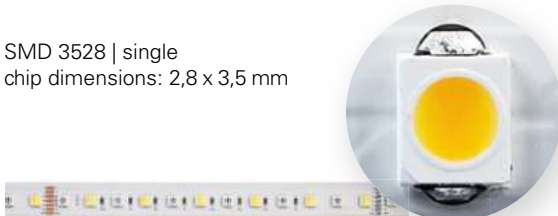

SMD 1808 | single
chip dimensions: 0,8 x 1,8 mm

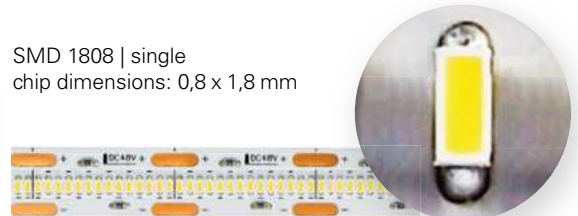

COB | single



COB STRIPES

These LED strips are ideal if the focus is on a homogeneous light pattern.





COB 24V-10W SAUNA IP67

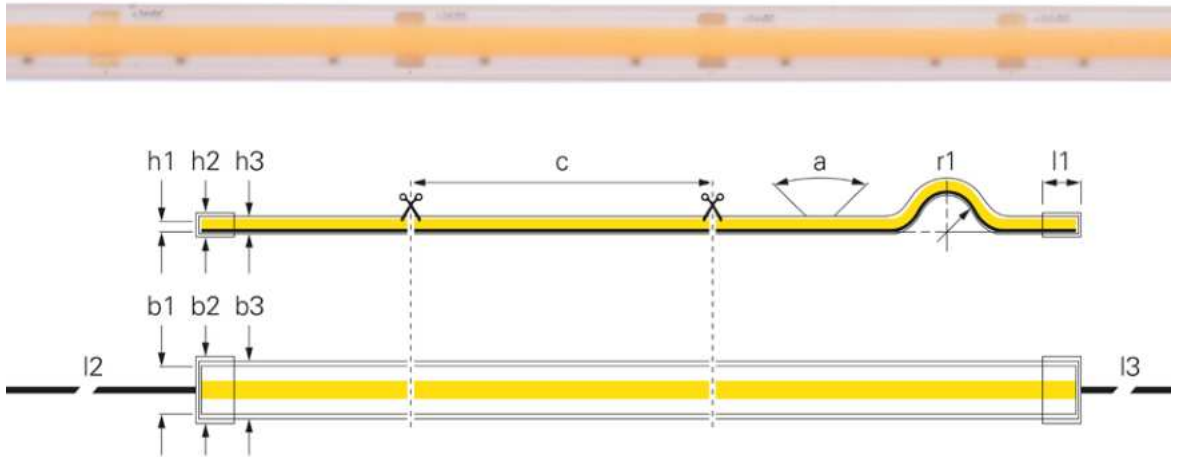

- for saunas and steam baths
- UV-resistant
- permanently temperature-resistant LED strip
- 2 m model ideal for home saunas with 2 m internal dimensions
- extra-long cable
- Service life 75,000 h L70B50/50,000 h L80B10

(c) Segment Length	50 mm	(l2) Primary Cable Length	1.8 m
(a) Light Beam Angle	180 Degree	(l3) Secondary Cable Length	1.8 m
(r1) Bending Radius min.	50 mm	Rated Input 1m	10 W
(h1) Height	5.5 mm	Rated Input Voltage	24 V/DC
(h2) Height End Cap	6.5 mm	Colour Rendering Index (Ra)	90
(h3) Length Hose	5.5 mm	Control	Dimmable via optional controller
(b1) Width	12 mm	Working Temperature	-10 to 105 °C
(b2) Width end cap	14.2 mm	Channels	1
(b3) Width hose	12 mm		
(l1) Length End Cap	10 mm		

Article	Colour Temperature	Luminous Efficiency 1m	Luminous Flux 1m	Length	Price
840409	2700 K	85 lm/W	850 lm	2000 mm	€ 99.95
840411	2700 K	85 lm/W	850 lm	5000 mm	€ 224.95
840410	3000 K	90 lm/W	900 lm	2000 mm	€ 99.95
840412	3000 K	90 lm/W	900 lm	5000 mm	€ 224.95

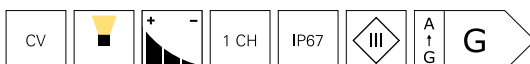



COB 24V-15W SAUNA IP67

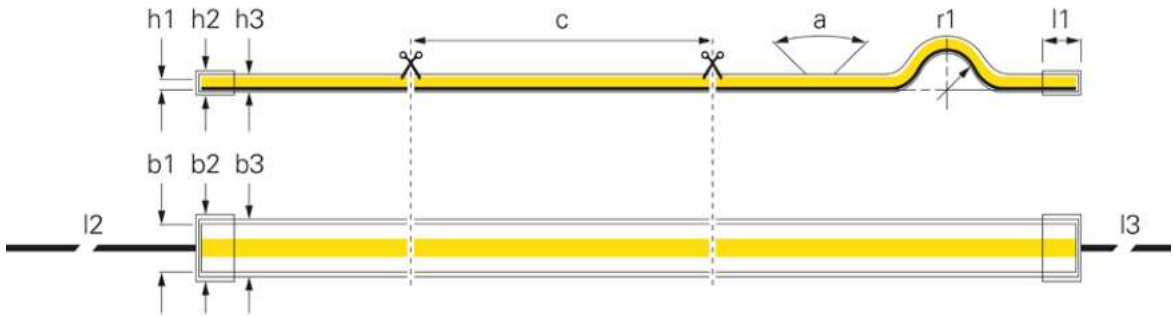

- for saunas and steam baths
- available in RGB and RGBW (2,700 K) versions
- UV-resistant
- permanently temperature-resistant LED strip
- 2 m model ideal for home saunas with 2 m internal dimensions
- extra-long cable
- Service life 75,000 h L70B50/50,000 h L80B10

(r1) Bending Radius min.	50 mm	(l2) Primary Cable Length	1.8 m
(h1) Height	5 mm	(l3) Secondary Cable Length	1.8 m
(h2) Height End Cap	6.5 mm	Rated Input 1m	15 W
(h3) Length Hose	14 mm	Rated Input Voltage	24 V/DC
(b1) Width	14 mm	Control	Dimmable via optional controller
(b2) Width end cap	16.2 mm	Working Temperature	-10 to 105 °C
(b3) Width hose	5 mm		
(l1) Length End Cap	10 mm		

Article	Colour Temperature	(c) Segment Length	Luminous Efficiency 1m	Luminous Flux 1m	Length	Price
840413		50 mm	30 lm/W	450 lm	2000 mm	€ 139.95
840415		50 mm	30 lm/W	450 lm	5000 mm	€ 314.95
840414		8.33 mm	40 lm/W	600 lm	2000 mm	€ 149.95
840416		8.33 mm	40 lm/W	600 lm	5000 mm	€ 334.95



Accessories

930797 silicone end cap Set 2 pcs for 24V COB RGB/RGBW Sauna stripe



€ 0.95

930802 silicone brackets for 24V COB RGB/RGBW Sauna stripe



€ 1.95

930803 Plastic profile 1m for 24V COB RGB/RGBW Sauna stripe



€ 5.95

Accessories

930804 Plastic profile 2m for 24V COB RGB/RGBW Sauna stripe



€ 11.95

Accessories for **840413**

930798 Feeder cable for 24V COB RGB Sauna stripe



€ 12.95

930799 Connector for 24V COB RGB Sauna stripe



€ 17.95



COB 24V-10W SHORT CUT IP20

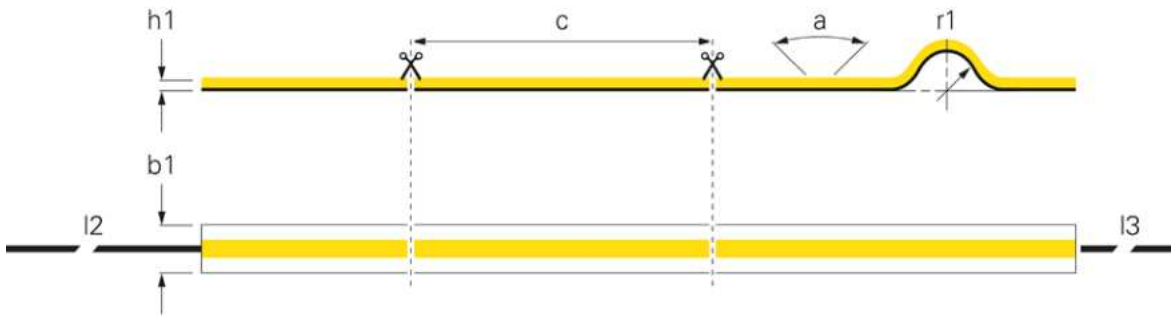

(p) LED Distance	1.74 mm	Luminous Flux 1m	960 lm
(c) Segment Length	50 mm	Length	5000 mm
(a) Light Beam Angle	120 Degree	Rated Input 1m	10.5 W
(r1) Bending Radius min.	50 mm	Rated Input Voltage	24 V/DC
(h1) Height	2 mm	Colour Rendering Index (Ra)	90
(b1) Width	10 mm	Control	Dimmable via optional controller
(I2) Primary Cable Length	1 m	Working Temperature	-10 to 60 °C
(I3) Secondary Cable Length	1 m	Channels	3
Colour Temperature	2700-6500 K		
Luminous Efficiency 1m	91.43 lm/W		

Article	Colour Temperature	Price
840374	WW CW 2700-6500 K	€ 299.95

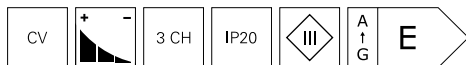

Power supply units

You can find the right power supply unit in various designs and with the required voltage and power in the »Power supply units« section.

COB 24V-12W STANDARD IP20

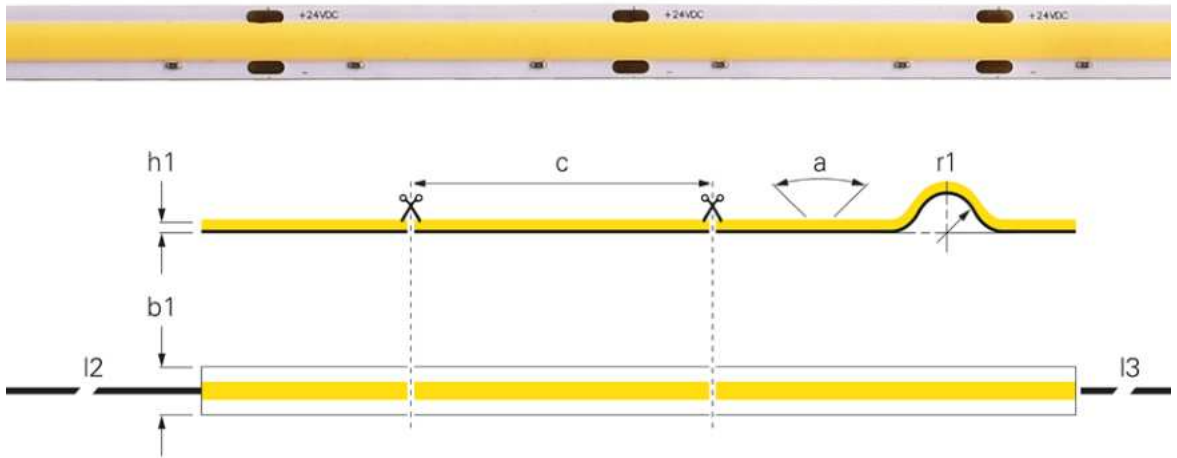

(p) LED Distance	2.08 mm	Length	5000 mm
(c) Segment Length	50 mm	Rated Input Voltage	24 V/DC
(a) Light Beam Angle	120 Degree	Colour Rendering Index (Ra)	90
(r1) Bending Radius min.	50 mm	Control	Dimmable via optional controller
(h1) Height	2 mm	Working Temperature	-15 to 50 °C
(b1) Width	10 mm	Channels	1
(I2) Primary Cable Length	1 m		
(I3) Secondary Cable Length	1 m		

Article	Colour Temperature	Luminous Efficiency 1m	Luminous Flux 1m	Rated Input 1m	Price
840296	3000 K	89.6 lm/W	1120 lm	12.5 W	€ 159.95
840304	4000 K	94.17 lm/W	1130 lm	12.0 W	€ 159.95

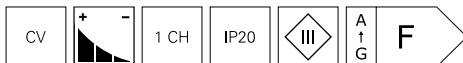
**Aluminium profiles**

In the »Aluminum profiles« section you will find the right profile for every application with various covers and installation options.

COB 24V-16W STANDARD IP20

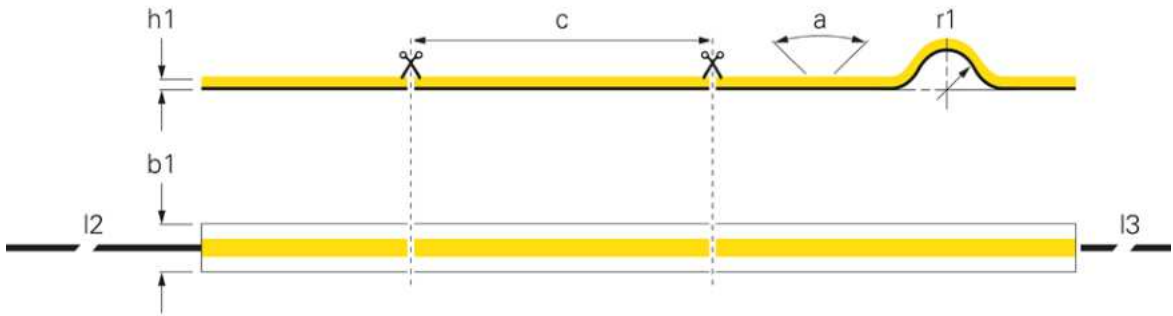

(p) LED Distance	1.19 mm	Luminous Flux 1m	660 lm
(c) Segment Length	50 mm	Length	5000 mm
(a) Light Beam Angle	120 Degree	Rated Input 1m	16.5 W
(r1) Bending Radius min.	50 mm	Rated Input Voltage	24 V/DC
(h1) Height	2.2 mm	Control	Dimmable via optional controller
(b1) Width	10 mm	Working Temperature	-10 to 60 °C
(l2) Primary Cable Length	1 m	Channels	3
(l3) Secondary Cable Length	1 m		
Luminous Efficiency 1m	40 lm/W		

Article Price

840375 € 399.95

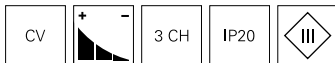

Lighting design

Interested in our lighting design service?

Your contact person will be happy to answer any questions you may have.





COB 24V-15W PERFORMANCE IP20

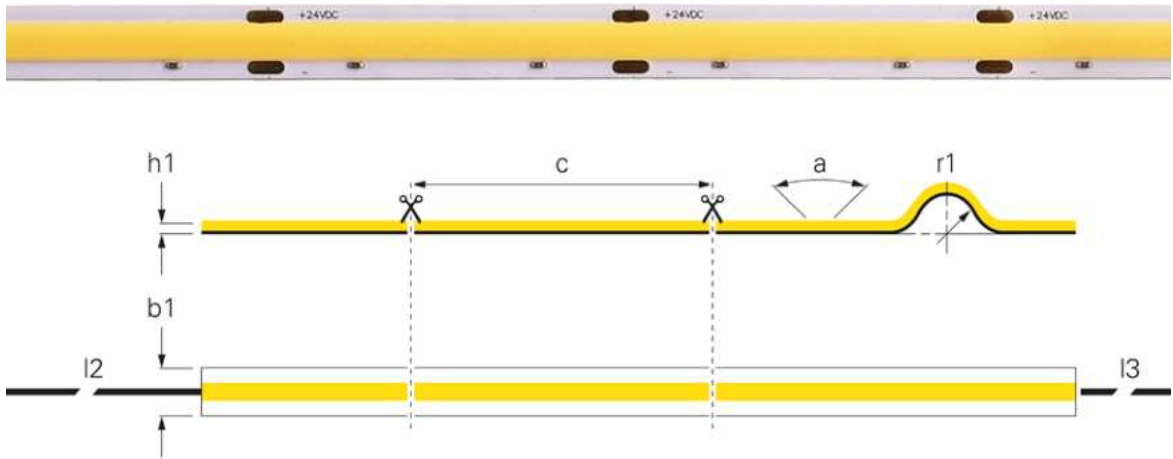

(p) LED Distance	2.08 mm	Length	5000 mm
(c) Segment Length	50 mm	Rated Input Voltage	24 V/DC
(a) Light Beam Angle	180 Degree	Colour Rendering Index (Ra)	90
(r1) Bending Radius min.	50 mm	Control	Dimmable via optional controller
(h1) Height	2 mm	Working Temperature	-15 to 50 °C
(b1) Width	10 mm	Channels	1
(I2) Primary Cable Length	1 m		
(I3) Secondary Cable Length	1 m		

Article	Colour Temperature	Luminous Efficiency 1m	Luminous Flux 1m	Rated Input 1m	Price
840323	3000 K	139.38 lm/W	2230 lm	16.0 W	€ 179.95
840324	4000 K	106.66 lm/W	1600 lm	15.0 W	€ 179.95

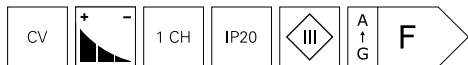

Power supply units

You can find the right power supply unit in various designs and with the required voltage and power in the »Power supply units« section.



COB 24V-15W PERFORMANCE IP67

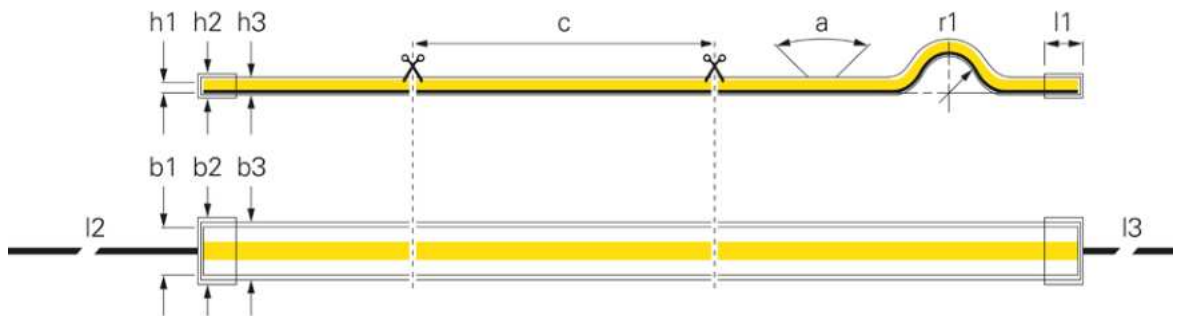

(p) LED Distance	2.08 mm	(l2) Primary Cable Length	1 m
(c) Segment Length	50 mm	(l3) Secondary Cable Length	1 m
(a) Light Beam Angle	180 Degree	Length	5000 mm
(r1) Bending Radius min.	50 mm	Rated Input 1m	15 W
(h1) Height	2 mm	Rated Input Voltage	24 V/DC
(h2) Height End Cap	6 mm	Colour Rendering Index (Ra)	90
(h3) Length Hose	5 mm	Control	Dimmable via optional controller
(b1) Width	10 mm	Type of IP Protection	Silicone
(b2) Width end cap	15 mm	Working Temperature	-15 to 50 °C
(b3) Width hose	14 mm	Channels	1
(l1) Length End Cap	10 mm		

Article	Colour Temperature	Luminous Efficiency 1m	Luminous Flux 1m	Price
840321 3000 K		148.33 lm/W	2225 lm	€ 199.95
840322 4000 K		163.67 lm/W	2455 lm	€ 199.95

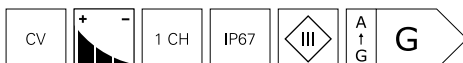
**Aluminium profiles**

In the »Aluminium profiles« section you will find the right profile for every application with various covers and installation options.

12V LED STRIPES

These LED strips are ideally suited for all standard applications and special assemblies with the most diverse requirements. With voltages of 12V, different protection classes, lumens, number of LEDs, power and much more, you too can find the right LED strip for your application.





SMD 12V-7W SHORT CUT IP20

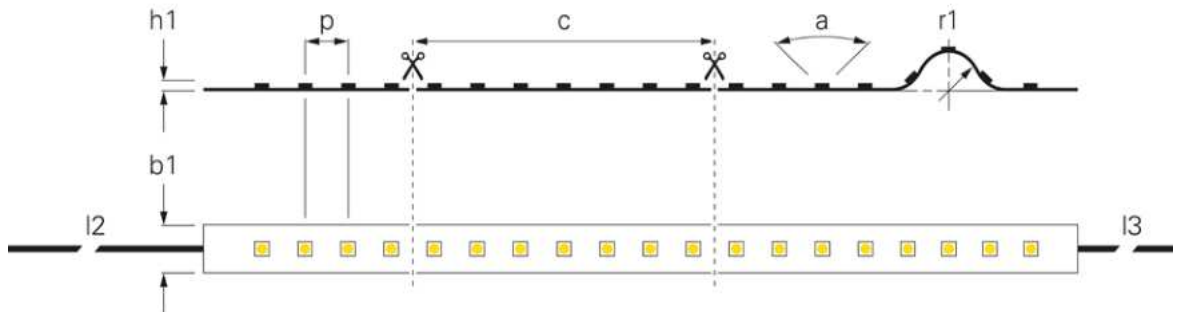

(p) LED Distance	8.33 mm	Length	5000 mm
(c) Segment Length	25 mm	Rated Input Voltage	12 V/DC
(a) Light Beam Angle	120 Degree	Colour Rendering Index (Ra)	90
(r1) Bending Radius min.	20 mm	Control	Dimmable via optional controller
(h1) Height	3 mm	Working Temperature	-15 to 50 °C
(b1) Width	8 mm	Channels	1
(l2) Primary Cable Length	1 m		
(l3) Secondary Cable Length	1 m		

Article	Colour Temperature	Luminous Efficiency 1m	Luminous Flux 1m	Rated Input 1m	EEL	Price
840164	2700 K	81.43 lm/W	570 lm	7.0 W		€ 89.95
840165	3000 K	85.38 lm/W	555 lm	6.5 W		€ 89.95
840166	4000 K	95.71 lm/W	670 lm	7.0 W		€ 89.95
840167	6500 K	90 lm/W	630 lm	7.0 W		€ 89.95

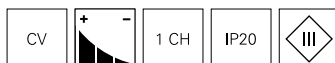

Aluminium profiles

In the »Aluminum profiles« section you will find the right profile for every application with various covers and installation options.



24V LED STRIPES

These LED strips are ideal for all standard applications and special assemblies with a wide range of requirements. With voltages of 24V, different protection classes, lumens, number of LEDs, power and much more, you too will find the right LED strip for your application.

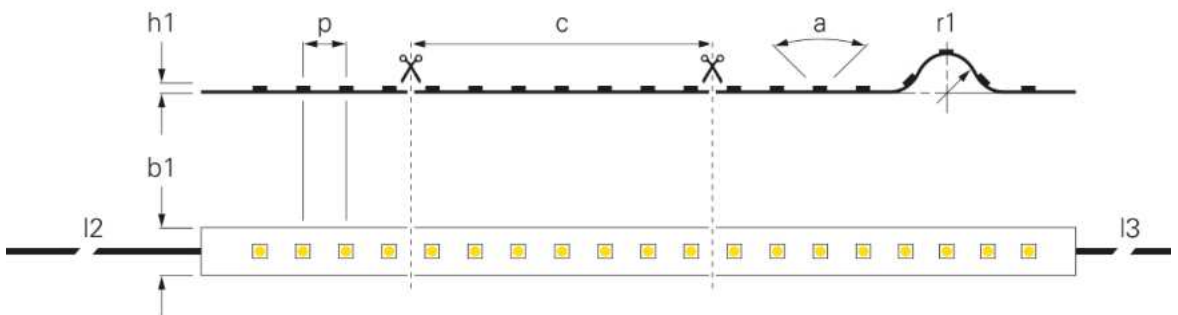

SMD 24V-14W STANDARD IP20

(p) LED Distance	5.56 mm	(I2) Primary Cable Length	1 m
(c) Segment Length	33.4 mm	(I3) Secondary Cable Length	1 m
(a) Light Beam Angle	120 Degree	Rated Input Voltage	24 V/DC
(r1) Bending Radius min.	20 mm	Control	Dimmable via optional controller
(h1) Height	3 mm	Channels	1
(b1) Width	8 mm		

Article	Colour Temp.	Luminous Efficiency 1m	Luminous Flux 1m	Length	Rated Input 1m	EEL	Price
840178	2700 K	79 lm/W	1110 lm	5000 mm	14,0 W		€ 124.95
840179	3000 K	81 lm/W	1100 lm	5000 mm	13,5 W		€ 124.95
930512	3000 K	81 lm/W	1100 lm	50000 mm	13,5 W		€ 1169.95
840180	4000 K	90 lm/W	1220 lm	5000 mm	13,5 W		€ 124.95





SMD 24V-10W LONG RUN IP20

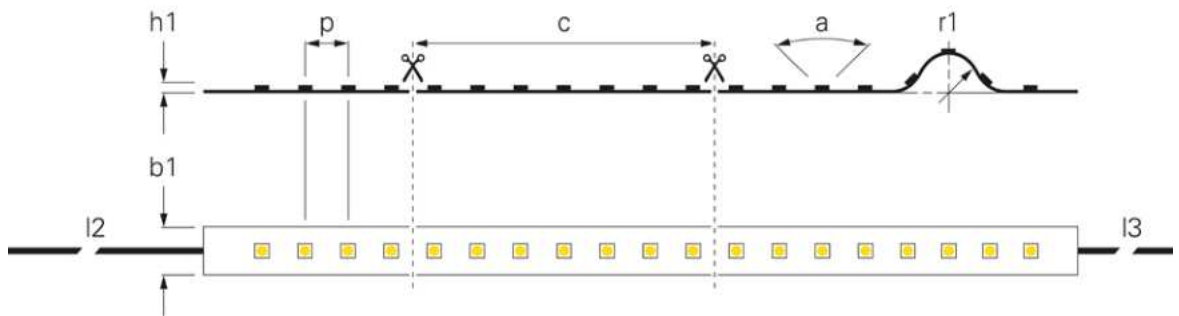

(p) LED Distance	8.33 mm	Luminous Flux 1m	705 lm
(c) Segment Length	50 mm	Length	10000 mm
(a) Light Beam Angle	120 Degree	Rated Input 1m	9.5 W
(r1) Bending Radius min.	20 mm	Rated Input Voltage	24 V/DC
(h1) Height	2 mm	Colour Rendering Index (Ra)	90
(b1) Width	10 mm	Control	Dimmable via optional controller
(l2) Primary Cable Length	1 m	Working Temperature	-15 to 50 °C
(l3) Secondary Cable Length	1 m	Channels	1
Colour Temperature	3000 K		
Luminous Efficiency 1m	74.21 lm/W		

Article Price

840291 **€ 399.95**

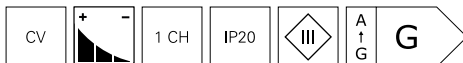

Power supply units

You can find the right power supply unit in various designs and with the required voltage and power in the »Power supply units« section.



SMD 24V-10W SLIM IP20

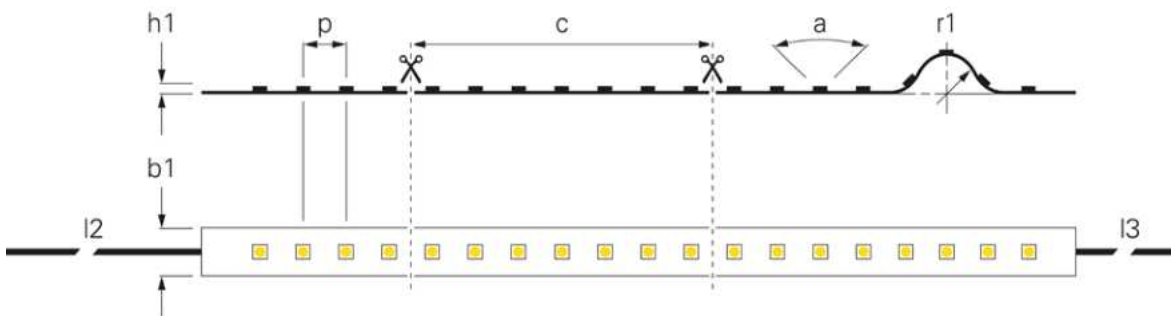

(p) LED Distance	8.33 mm	Length	5000 mm
(c) Segment Length	50 mm	Rated Input Voltage	24 V/DC
(a) Light Beam Angle	120 Degree	Colour Rendering Index (Ra)	90
(r1) Bending Radius min.	20 mm	Control	Dimmable via optional controller
(h1) Height	3 mm	Working Temperature	-15 to 50 °C
(b1) Width	5 mm	Channels	1
(I2) Primary Cable Length	1 m		
(I3) Secondary Cable Length	1 m		

Article	Colour Temperature	Luminous Efficiency 1m	Luminous Flux 1m	Rated Input 1m	Price
840158	2700 K	80 lm/W	680 lm	8.5 W	€ 79.95
840159	3000 K	69.52 lm/W	730 lm	10.5 W	€ 79.95

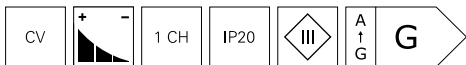

Aluminium profiles

In the »Aluminum profiles« section you will find the right profile for every application with various covers and installation options.



SMD 24V-11W SLIM IP20

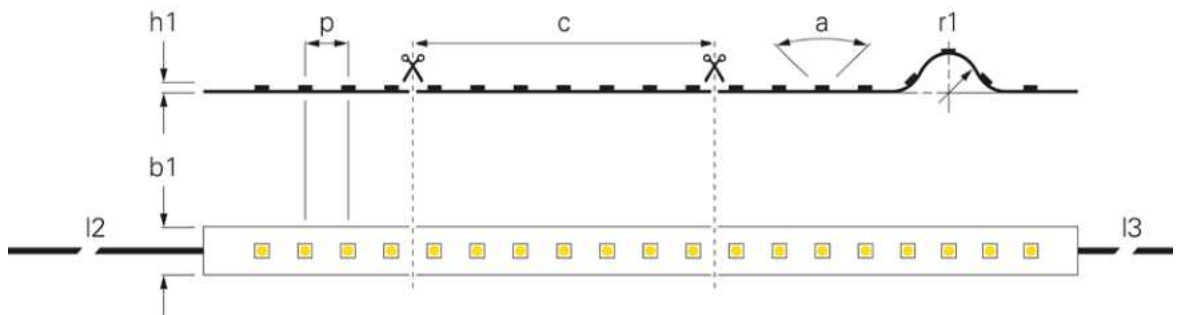

(p) LED Distance	3.75 mm	Length	5000 mm
(a) Light Beam Angle	120 Degree	Rated Input Voltage	24 V/DC
(r1) Bending Radius min.	20 mm	Colour Rendering Index (Ra)	90
(h1) Height	2 mm	Control	Dimmable via optional controller
(b1) Width	4 mm	Working Temperature	-15 to 50 °C
(I2) Primary Cable Length	1 m	Channels	1
(I3) Secondary Cable Length	1 m		

Article	Colour Temperature	(c) Segment Length	Luminous Efficiency 1m	Luminous Flux 1m	Rated Input 1m	Price
840175	2700 K	25 mm	90.45 lm/W	995 lm	11.0 W	€ 169.95
840210	3000 K	33.4 mm	99.09 lm/W	1090 lm	11.0 W	€ 169.95
840267	4000 K	33.4 mm	95.65 lm/W	1100 lm	11.5 W	€ 169.95



Power supply units

You can find the right power supply unit in various designs and with the required voltage and power in the »Power supply units« section.

SMD 24V-12W SLIM IP65

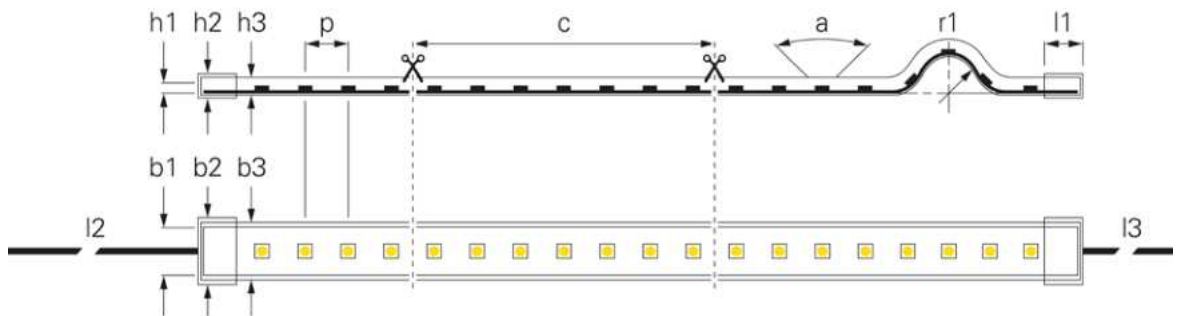

(p) LED Distance	10.2 mm	Colour Temperature	3000-6500 K
(c) Segment Length	71.4 mm	Luminous Efficiency 1m	85.6 lm/W
(a) Light Beam Angle	120 Degree	Luminous Flux 1m	1070 lm
(r1) Bending Radius min.	50 mm	Length	5000 mm
(h1) Height	2 mm	Rated Input 1m	12.5 W
(h2) Height End Cap	7 mm	Rated Input Voltage	24 V/DC
(h3) Length Hose	3 mm	Colour Rendering Index (Ra)	90
(b1) Width	5 mm	Control	Dimmable via optional controller
(b2) Width end cap	11 mm	Type of IP Protection	Silicone hose
(b3) Width hose	7 mm	Working Temperature	-10 to 60 °C
(l1) Length End Cap	3 mm	Channels	2
(l2) Primary Cable Length	1 m		
(l3) Secondary Cable Length	1 m		

Article Colour Temperature

Price

840349 WW CW 3000-6500 K

€ 149.95

**Power supply units**

You can find the right power supply unit in various designs and with the required voltage and power in the »Power supply units« section.



SMD 24V-11W STANDARD IP20

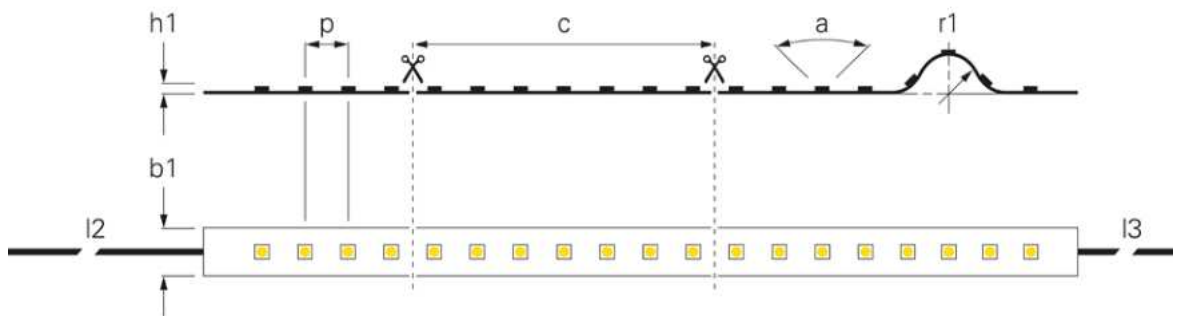

(p) LED Distance	8.33 mm	Luminous Flux 1m	500 lm
(c) Segment Length	50 mm	Length	5000 mm
(a) Light Beam Angle	110 Degree	Rated Input 1m	11 W
(r1) Bending Radius min.	20 mm	Rated Input Voltage	24 V/DC
(h1) Height	2 mm	Colour Rendering Index (Ra)	60
(b1) Width	5 mm	Control	Dimmable via optional controller
(I2) Primary Cable Length	1 m	Working Temperature	-15 to 50 °C
(I3) Secondary Cable Length	1 m	Channels	3
Luminous Efficiency 1m	45.45 lm/W		

Article Price

840276  **€ 109.95**

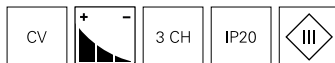

Power supply units

You can find the right power supply unit in various designs and with the required voltage and power in the »Power supply units« section.



SMD 24V-11W STANDARD IP67

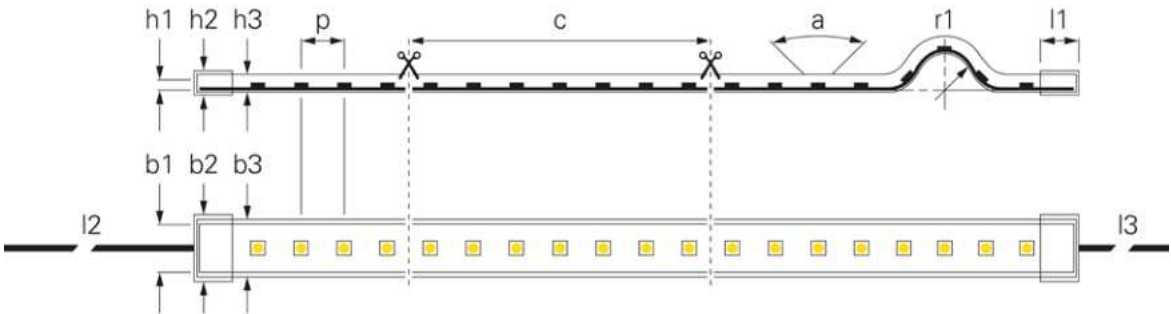

(p) LED Distance	5.56 mm	(l2) Primary Cable Length	1 m
(a) Light Beam Angle	120 Degree	(l3) Secondary Cable Length	1 m
(r1) Bending Radius min.	50 mm	Length	5000 mm
(h1) Height	1.2 mm	Rated Input Voltage	24 V/DC
(h2) Height End Cap	6.5 mm	Colour Rendering Index (Ra)	90
(h3) Length Hose	5.5 mm	Control	Dimmable via optional controller
(b1) Width	8 mm	Type of IP Protection	Silicone hose
(b2) Width end cap	13.7 mm	Working Temperature	-15 to 50 °C
(b3) Width hose	11.5 mm	Channels	1
(l1) Length End Cap	10 mm		

Article	Colour Temperature	(c) Segment Length	Luminous Efficiency 1m	Luminous Flux 1m	Rated Input 1m	Price
840186	2700 K	50 mm	78.26 lm/W	900 lm	11.5 W	€ 184.95
840187	3000 K	166.5 mm	84.55 lm/W	930 lm	11.0 W	€ 184.95

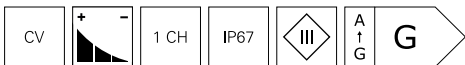

Aluminium profiles

In the »Aluminum profiles« section you will find the right profile for every application with various covers and installation options.



SMD 24V-15W STANDARD IP67

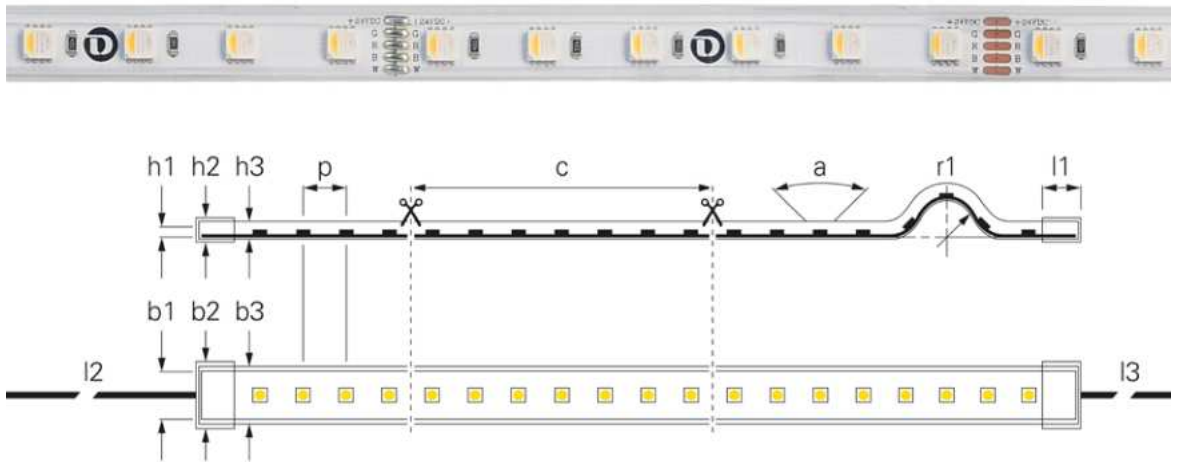

(p) LED Distance	16.66 mm	Colour Temperature	3000 K
(c) Segment Length	100 mm	Luminous Efficiency 1m	49 lm/W
(a) Light Beam Angle	120 Degree	Luminous Flux 1m	735 lm
(r1) Bending Radius min.	50 mm	Length	5000 mm
(h1) Height	1.7 mm	Rated Input 1m	15 W
(h2) Height End Cap	5.2 mm	Rated Input Voltage	24 V/DC
(h3) Length Hose	4.2 mm	Colour Rendering Index (Ra)	80
(b1) Width	10 mm	Control	Dimmable via optional controller
(b2) Width end cap	14.8 mm	Type of IP Protection	Silicone hose
(b3) Width hose	12.6 mm	Working Temperature	-15 to 50 °C
(l1) Length End Cap	10 mm	Channels	4
(l2) Primary Cable Length	1 m		
(l3) Secondary Cable Length	1 m		

Article Price

840239 RGB WW **€ 174.95**



Power supply units

You can find the right power supply unit in various designs and with the required voltage and power in the »Power supply units« section.



SMD 24V-16W RGBNW STANDARD IP20

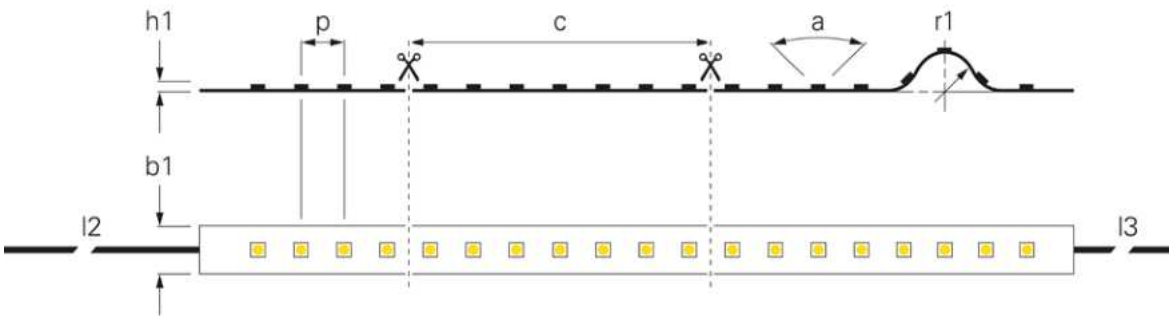

(p) LED Distance	16.66 mm	Luminous Flux 1m	775 lm
(c) Segment Length	62.5 mm	Length	5000 mm
(a) Light Beam Angle	120 Degree	Rated Input 1m	16.5 W
(r1) Bending Radius min.	50 mm	Rated Input Voltage	24 V/DC
(h1) Height	2 mm	Colour Rendering Index (Ra)	80
(b1) Width	10 mm	Control	Dimmable via optional controller
(I2) Primary Cable Length	1 m	Working Temperature	-10 to 60 °C
(I3) Secondary Cable Length	1 m	Channels	4
Colour Temperature	4000 K		
Luminous Efficiency 1m	46.97 lm/W		

Article Price

840353 RGB NW **€ 149.95**

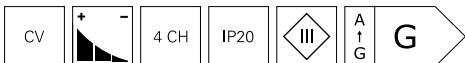

Aluminium profiles

In the »Aluminum profiles« section you will find the right profile for every application with various covers and installation options.



SMD 24V-16W RGBWW STANDARD IP20

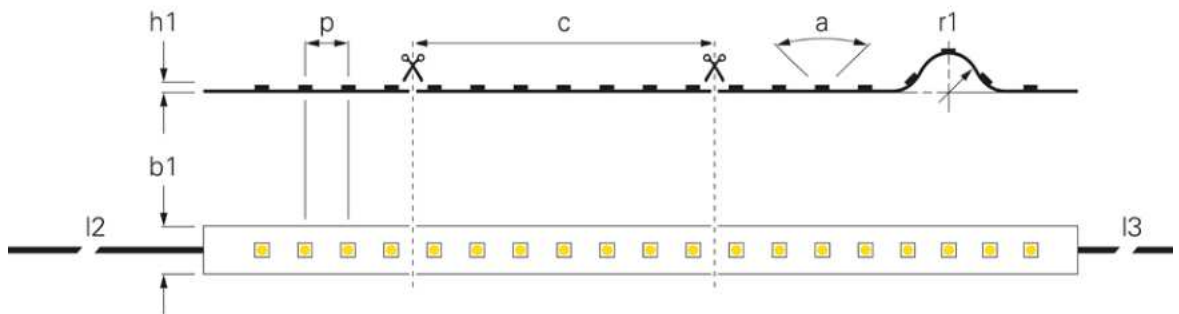

(p) LED Distance	16.66 mm	Luminous Efficiency 1m	51.25 lm/W
(c) Segment Length	100 mm	Luminous Flux 1m	820 lm
(a) Light Beam Angle	120 Degree	Rated Input 1m	16 W
(r1) Bending Radius min.	50 mm	Rated Input Voltage	24 V/DC
(h1) Height	3 mm	Colour Rendering Index (Ra)	80
(b1) Width	10 mm	Control	Dimmable via optional controller
(l2) Primary Cable Length	1 m	Working Temperature	-15 to 50 °C
(l3) Secondary Cable Length	1 m	Channels	4
Colour Temperature	3000 K		

Article		Length	Price
840236		5000 mm	€ 144.95
930517		50000 mm	€ 1299.95

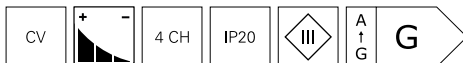

Power supply units

You can find the right power supply unit in various designs and with the required voltage and power in the »Power supply units« section.



SMD 24V-17W STANDARD IP20

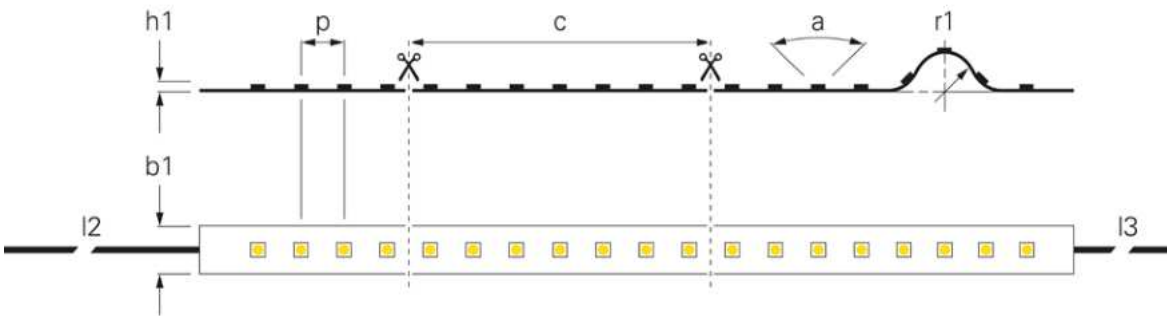

(p) LED Distance	8.33 mm	Luminous Flux 1m	1765 lm
(c) Segment Length	50 mm	Length	5000 mm
(a) Light Beam Angle	120 Degree	Rated Input 1m	17.2 W
(r1) Bending Radius min.	50 mm	Rated Input Voltage	24 V/DC
(h1) Height	2 mm	Colour Rendering Index (Ra)	90
(b1) Width	10 mm	Control	Dimmable via optional controller
(I2) Primary Cable Length	1 m	Working Temperature	-10 to 40 °C
(I3) Secondary Cable Length	1 m	Channels	2
Colour Temperature	2700-6500 K		
Luminous Efficiency 1m	103 lm/W		

Article Colour Temperature Price

840378 **WW** **CW** 2700-6500 K

€ 199.95

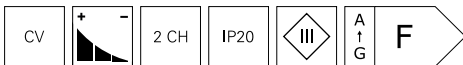

Aluminium profiles

In the »Aluminum profiles« section you will find the right profile for every application with various covers and installation options.



SMD 24V-20W POWER IP20

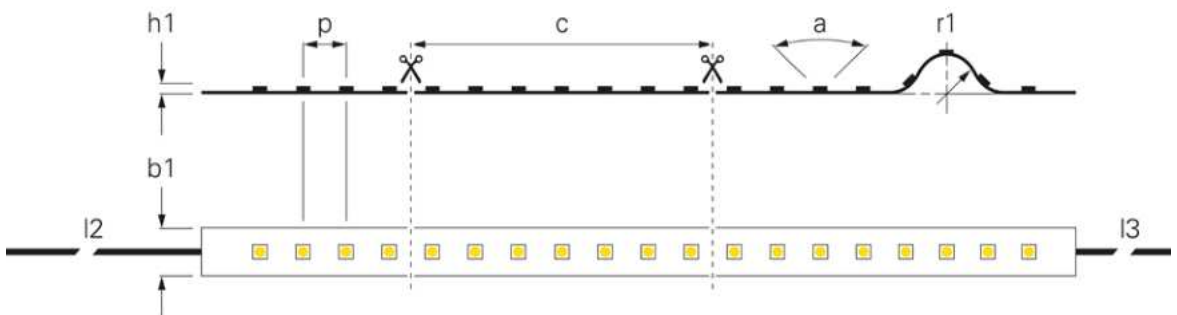

(a) Light Beam Angle	120 Degree	Length	5000 mm
(r1) Bending Radius min.	20 mm	Rated Input Voltage	24 V/DC
(h1) Height	2 mm	Control	Dimmable via optional controller
(b1) Width	10 mm	Working Temperature	-15 to 50 °C
(I2) Primary Cable Length	1 m	Channels	1
(I3) Secondary Cable Length	1 m		

Article	Colour Temp.	(p) LED Distance	(c) Segment Length	Luminous Efficiency 1m	Luminous Flux 1m	EEL	Price
840192	2700 K	4.16 mm	25 mm	65.68 lm/W	1215 lm		€ 164.95
840193	3000 K	4.16 mm	25 mm	84.47 lm/W	1605 lm		€ 164.95
840122	3000 K	8.33 mm	50 mm	75.95 lm/W	1595 lm		€ 194.95
840194	4000 K	4.16 mm	25 mm	88.5 lm/W	1770 lm		€ 164.95
840124	6000 K	8.33 mm	50 mm	86 lm/W	1720 lm		€ 194.95

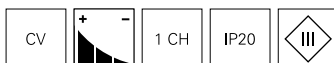

Power supply units

You can find the right power supply unit in various designs and with the required voltage and power in the »Power supply units« section.



SMD 24V-22W POWER IP20

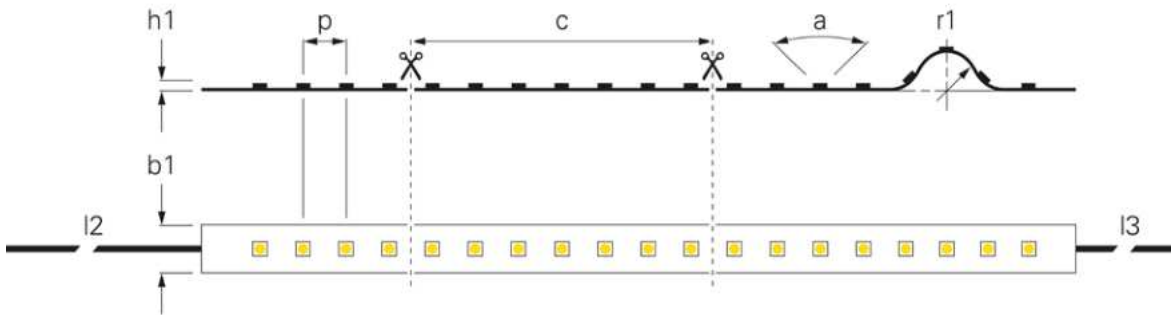

(p) LED Distance	6.25 mm	Length	5000 mm
(c) Segment Length	50 mm	Rated Input 1m	22.5 W
(a) Light Beam Angle	110 Degree	Rated Input Voltage	24 V/DC
(r1) Bending Radius min.	20 mm	Colour Rendering Index (Ra)	90
(h1) Height	2 mm	Control	Dimmable via optional controller
(b1) Width	10 mm	Working Temperature	-15 to 50 °C
(I2) Primary Cable Length	1 m	Channels	1
(I3) Secondary Cable Length	1 m		

Article	Colour Temperature	Luminous Efficiency 1m	Luminous Flux 1m	EEL	Price
840331	WW 3000 K	114.22 lm/W	2570 lm		€ 249.95
840332	NW 4000 K	125.11 lm/W	2815 lm		€ 249.95



Aluminium profiles

In the »Aluminum profiles« section you will find the right profile for every application with various covers and installation options.

SMD 24V-22W RGBW POWER IP20

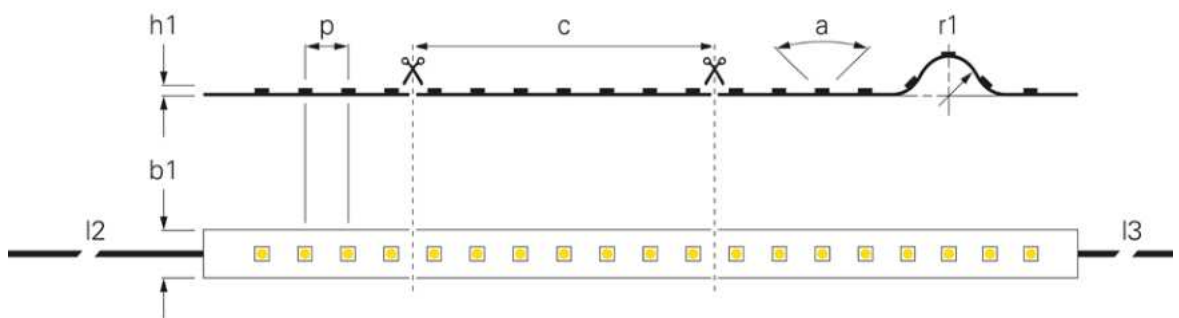

(p) LED Distance	10.4 mm	Length	5000 mm
(a) Light Beam Angle	110 Degree	Rated Input 1m	22 W
(r1) Bending Radius min.	20 mm	Rated Input Voltage	24 V/DC
(h1) Height	2 mm	Colour Rendering Index (Ra)	60
(b1) Width	12 mm	Control	Dimmable via optional controller
(I2) Primary Cable Length	1 m	Working Temperature	-15 to 50 °C
(I3) Secondary Cable Length	1 m		

Article	Colour Temperature	(c) Segment Length	Luminous Efficiency 1m	Luminous Flux 1m	Channels	EEL	Price
840308	3000 K	100 mm	43.41 lm/W	955 lm	4		€ 179.95
840309	4000 K	50 mm	44.77 lm/W	985 lm	4		€ 179.95

**Power supply units**

You can find the right power supply unit in various designs and with the required voltage and power in the »Power supply units« section.



SMD 24V-28W POWER PLUS IP20

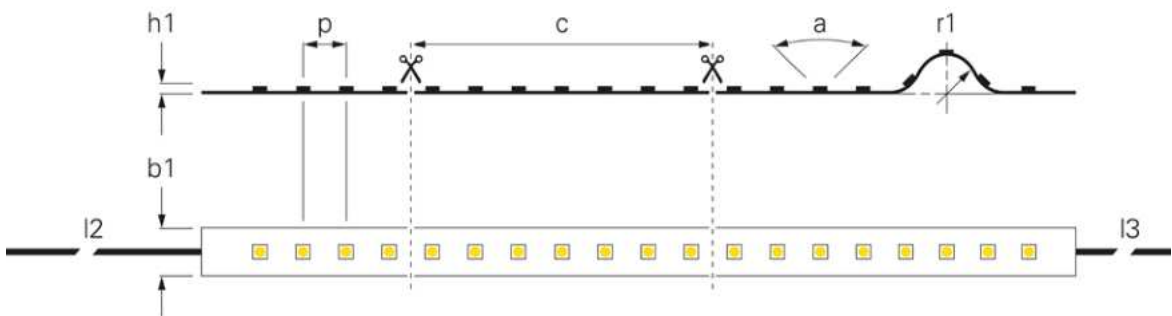

(p) LED Distance	8.33 mm	Luminous Flux 1m	1055 lm
(c) Segment Length	50 mm	Length	5000 mm
(a) Light Beam Angle	120 Degree	Rated Input 1m	28 W
(r1) Bending Radius min.	50 mm	Rated Input Voltage	24 V/DC
(h1) Height	2 mm	Colour Rendering Index (Ra)	60
(b1) Width	12 mm	Control	Dimmable via optional controller
(I2) Primary Cable Length	1 m	Working Temperature	-10 to 60 °C
(I3) Secondary Cable Length	1 m	Channels	3
Luminous Efficiency 1m	37.68 lm/W		

Article Price

840352  **€ 189.95**

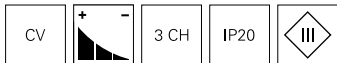

Aluminium profiles

In the »Aluminum profiles« section you will find the right profile for every application with various covers and installation options.



SMD 24V-28W POWER PLUS IP44

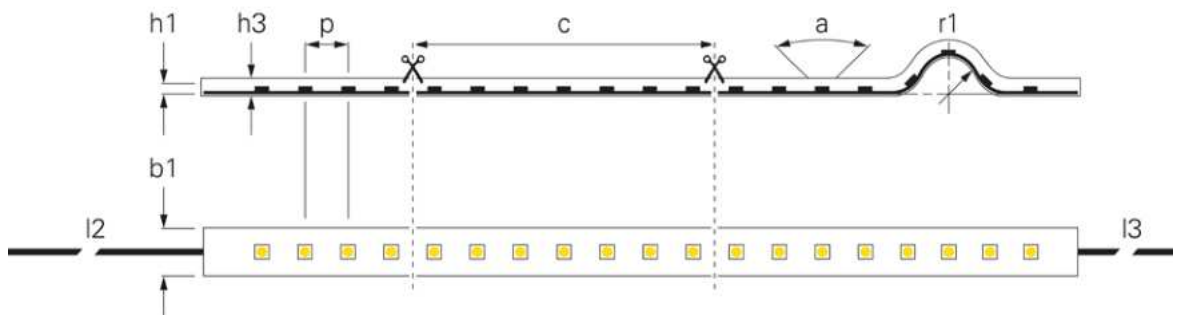

(p) LED Distance	8.33 mm	Luminous Flux 1m	1045 lm
(c) Segment Length	50 mm	Length	5000 mm
(a) Light Beam Angle	120 Degree	Rated Input 1m	27.5 W
(r1) Bending Radius min.	50 mm	Rated Input Voltage	24 V/DC
(h1) Height	1 mm	Colour Rendering Index (Ra)	60
(h3) Length Hose	2 mm	Control	Dimmable via optional controller
(b1) Width	12 mm	Type of IP Protection	Silicone
(b3) Width hose	14 mm	Working Temperature	-10 to 60 °C
(l2) Primary Cable Length	1 m	Channels	3
(l3) Secondary Cable Length	1 m		
Luminous Efficiency 1m	38 lm/W		

Article Price

840351  **€ 214.95**

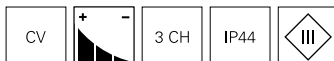

Power supply units

You can find the right power supply unit in various designs and with the required voltage and power in the »Power supply units« section.

SIDE VIEW

The LED strip is arranged / installed vertically, allowing the Flex-Stripe to be bent to the left and right.
[Note the minimum bending radius in each case.]





NEON 24V-10W D FLEX LINE MINI SIDE-VIEW IP44

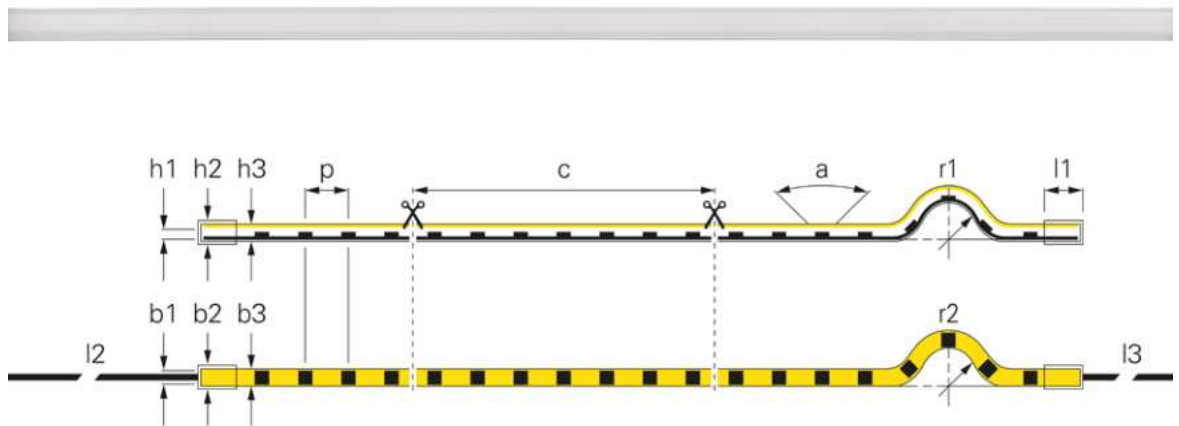

(p) LED Distance	8.33 mm	Luminous Flux 1m	285 lm
(c) Segment Length	50 mm	Length	5000 mm
(a) Light Beam Angle	112 Degree	Rated Input 1m	10 W
(r1) Bending Radius min.	50 mm	Rated Input Voltage	24 V/DC
(h1) Height	12 mm	Colour Rendering Index (Ra)	90
(b1) Width	6.5 mm	Control	Dimmable via optional controller
(l2) Primary Cable Length	3 m	Type of IP Protection	Silicone
(l3) Secondary Cable Length	3 m	Working Temperature	-25 to 45 °C
Colour Temperature	3000 K	Channels	1
Luminous Efficiency 1m	30 lm/W		

Article Price

840376 **€ 359.95**

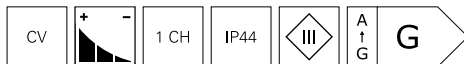

Accessories

930443	Profile for D Flex Line		€ 12.95
930444	Flex profile for D Flex Line		€ 21.95
930530	Mounting set for D Flex Line 6,5 x 12,0 mm		€ 9.95
930593	Gel glue for gluing end caps, 3g		€ 5.95

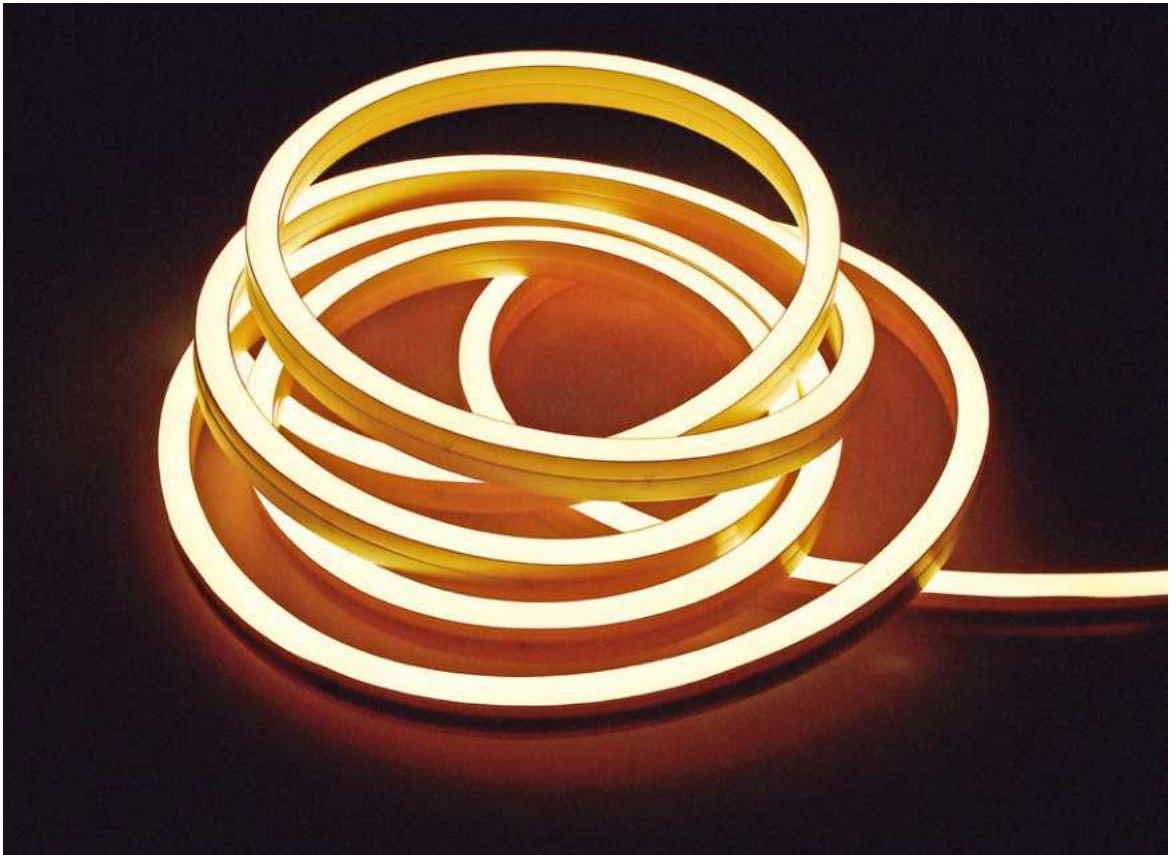



NEON 24V-8W D FLEX LINE MINI SIDE-VIEW IP68

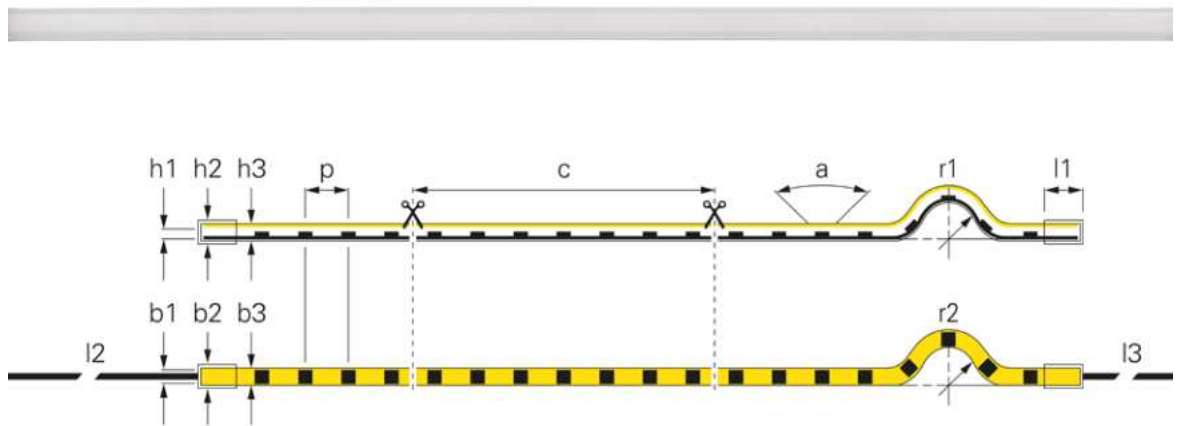

(p) LED Distance	8.33 mm	Luminous Flux 1m	295 lm
(c) Segment Length	50 mm	Length	5000 mm
(a) Light Beam Angle	112 Degree	Rated Input 1m	8 W
(r1) Bending Radius min.	50 mm	Rated Input Voltage	24 V/DC
(h1) Height	12 mm	Colour Rendering Index (Ra)	80
(b1) Width	6.5 mm	Control	Dimmable via optional controller
(l2) Primary Cable Length	3 m	Type of IP Protection	PVC cover
(l3) Secondary Cable Length	3 m	Working Temperature	-25 to 45 °C
Colour Temperature	3000 K	Channels	1
Luminous Efficiency 1m	36.88 lm/W		

Article Price

840283 **€ 559.95**

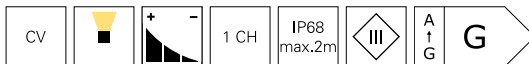

Accessories

930443	Profile for D Flex Line		€ 12.95
930444	Flex profile for D Flex Line		€ 21.95
930530	Mounting set for D Flex Line 6,5 x 12,0 mm		€ 9.95
930593	Gel glue for gluing end caps, 3g		€ 5.95





NEON 24V-10W D FLEX LINE SIDE-VIEW IP68

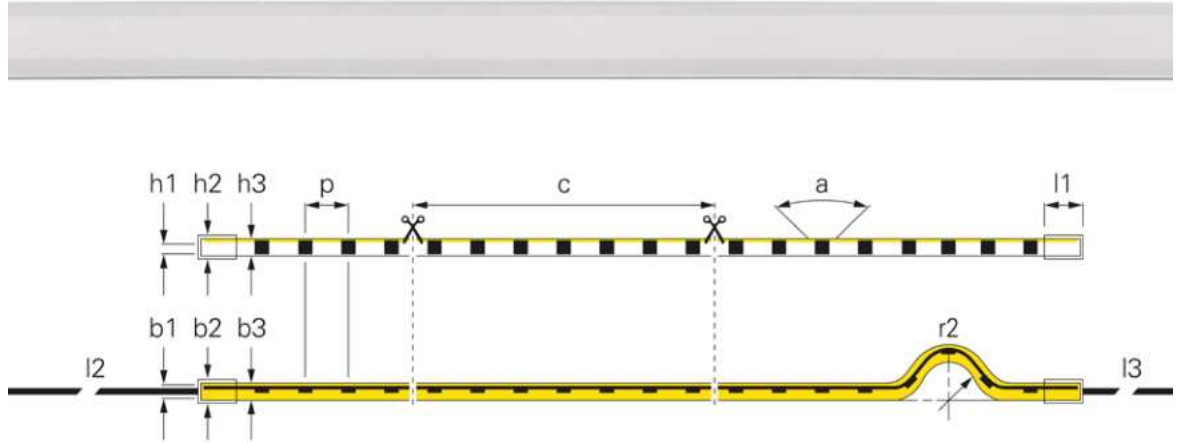

- spot-free homogeneous illumination
- very easy installation using adapted profile
- UV and salt water-resistant IP68
- ultra-flexible and therefore very versatile
- light-fast polyurethane encapsulation

(a) Light Beam Angle	125 Degree	(l3) Secondary Cable Length	3 m
(r1) Bending Radius min.	150 mm	Length	5000 mm
(h1) Height	20 mm	Rated Input 1m	10.5 W
(h2) Height End Cap	23 mm	Rated Input Voltage	24 V/DC
(h3) Length Hose	20 mm	Colour Rendering Index (Ra)	80
(b1) Width	12 mm	Control	Dimmable via optional controller
(b2) Width end cap	15 mm	Type of IP Protection	PVC cover
(b3) Width hose	12 mm	Working Temperature	-25 to 45 °C
(l1) Length End Cap	8 mm		
(l2) Primary Cable Length	3 m		

Article	Colour Temperature	(p) LED Distance	(c) Segment Length	Luminous Efficiency 1m	Luminous Flux 1m	Price
840287	3000 K	6.94 mm	100 mm	35.05 lm/W	368 lm	€ 799.95
840290	3200 K	11.91 mm	166.66 mm	20 lm/W	210 lm	€ 799.95

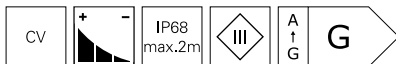

Accessories

930447	Profile for D Flex Line SIDE		€ 14.95
930451	Flex profile for D Flex Line Side		€ 26.95
930532	Mounting set for D Flex Line 12,0 x 20,0 mm		€ 9.95
930593	Gel glue for gluing end caps, 3g		€ 5.95

TOP VIEW

The LED strip is arranged / installed horizontally, allowing the Flex-Stripe to be bent upwards and downwards. [Note the minimum bending radius in each case.]



NEON 24V-10W D FLEX LINE TOP-VIEW IP68

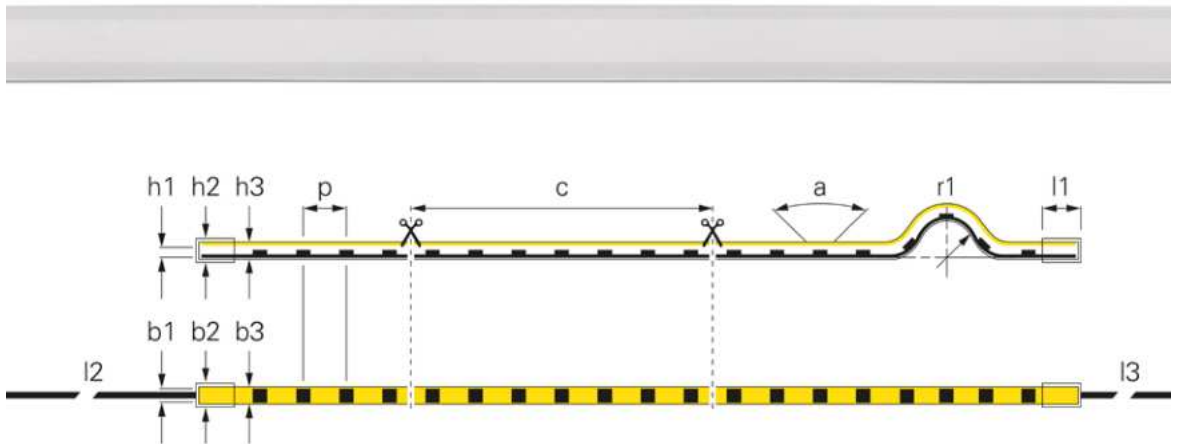

- spot-free homogeneous illumination
- very easy installation using adapted profile
- UV and salt water-resistant IP68
- ultra-flexible and therefore very versatile
- light-fast polyurethane encapsulation

(p) LED Distance	6.94 mm	Colour Temperature	3000 K
(c) Segment Length	166.66 mm	Luminous Efficiency 1m	49.05 lm/W
(a) Light Beam Angle	117 Degree	Luminous Flux 1m	515 lm
(r1) Bending Radius min.	150 mm	Length	5000 mm
(h1) Height	15 mm	Rated Input 1m	10.5W
(h2) Height End Cap	18 mm	Rated Input Voltage	24 V/DC
(h3) Length Hose	15 mm	Colour Rendering Index (Ra)	80
(b1) Width	16 mm	Control	Dimmable via optional controller
(b2) Width end cap	19 mm	Type of IP Protection	PVC cover
(b3) Width hose	16 mm	Working Temperature	-25 to 45 °C
(l1) Length End Cap	8 mm	Channels	1
(l2) Primary Cable Length	3 m		
(l3) Secondary Cable Length	3 m		

Article Price

840288 **€ 749.95**

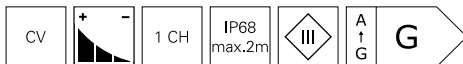

Accessories

930448	Profile for D Flex Line TOP		€ 14.94
930449	Profile for D Flex Line TOP		€ 11.95
930533	Mounting set for D Flex Line 16,0 x 15,0 mm		€ 10.95
930593	Gel glue for gluing end caps, 3g		€ 5.95





NEON 24V-10W D FLEX LINE TOP-VIEW WIDE IP68

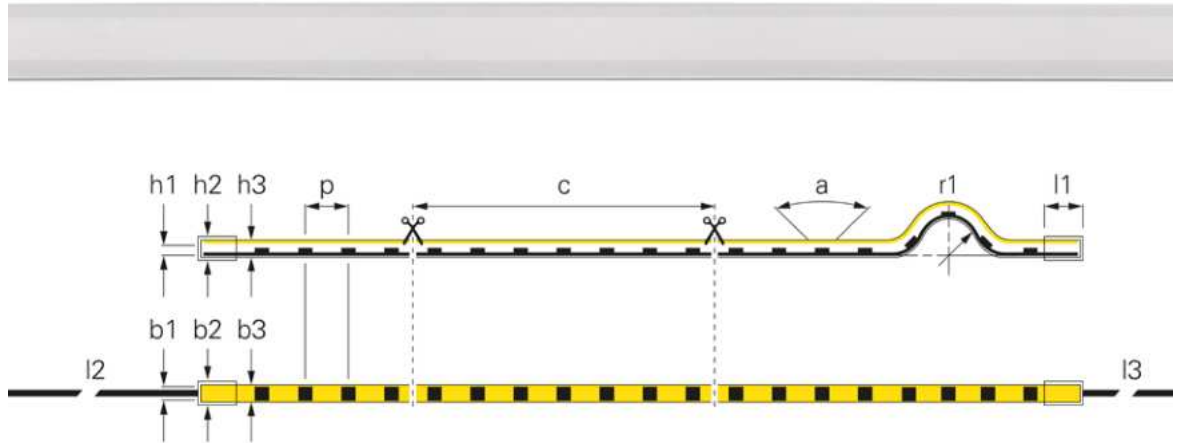

- spot-free homogeneous illumination
- very easy installation using adapted profile
- UV and salt water-resistant IP68
- ultra-flexible and therefore very versatile
- light-fast polyurethane encapsulation



(p) LED Distance	6.94 mm	Colour Temperature	3000 K
(c) Segment Length	100 mm	Luminous Efficiency 1m	69.52 lm/W
(a) Light Beam Angle	180 Degree	Luminous Flux 1m	730 lm
(r1) Bending Radius min.	150 mm	Length	5000 mm
(h1) Height	10 mm	Rated Input 1m	10.5 W
(h2) Height End Cap	13 mm	Rated Input Voltage	24 V/DC
(h3) Length Hose	10 mm	Colour Rendering Index (Ra)	80
(b1) Width	10 mm	Control	Dimmable via optional controller
(b2) Width end cap	13 mm	Type of IP Protection	PVC cover
(b3) Width hose	10 mm	Working Temperature	-25 to 45 °C
(l1) Length End Cap	8 mm	Channels	1
(l2) Primary Cable Length	3 m		
(l3) Secondary Cable Length	3 m		

Article Price

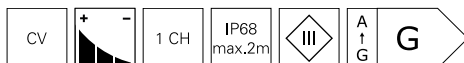
840285 WW € 479.95



Accessories

930445	Profile for D Flex Line MINI		€ 10.95
930446	Profile for D Flex Line MINI		€ 14.94
930531	Mounting set for D Flex Line 10,0 x 10,0 mm		€ 10.95

NEON 24V-10W RGB D FLEX LINE TOP-VIEW IP68

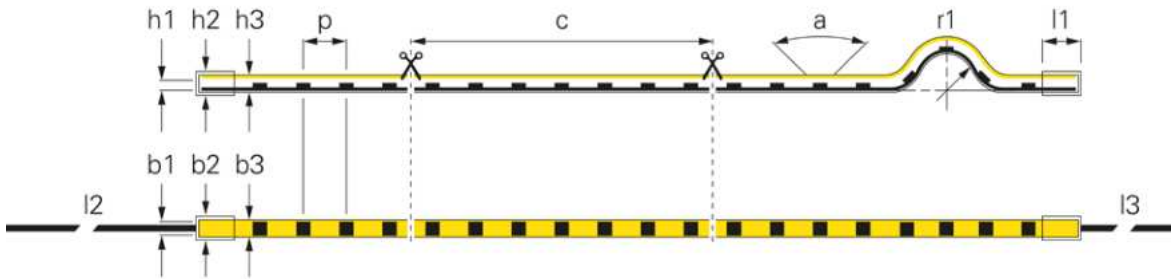



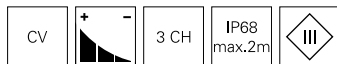

- spot-free homogeneous illumination
- very easy installation using adapted profile
- UV and salt water-resistant IP68
- ultra-flexible and therefore very versatile
- light-fast polyurethane encapsulation

(p) LED Distance	8.33 mm	(l3) Secondary Cable Length	3 m
(c) Segment Length	50 mm	Luminous Efficiency 1m	44712 lm/W
(a) Light Beam Angle	180 Degree	Luminous Flux 1m	315 lm
(r1) Bending Radius min.	150 mm	Length	5000 mm
(h1) Height	10 mm	Rated Input 1m	10 W
(h2) Height End Cap	13 mm	Rated Input Voltage	24 V/DC
(h3) Length Hose	10 mm	Colour Rendering Index (Ra)	80
(b1) Width	10 mm	Control	Dimmable via optional controller
(b2) Width end cap	13 mm	Type of IP Protection	PVC cover
(b3) Width hose	10 mm	Working Temperature	-25 to 45 °C
(l1) Length End Cap	8 mm	Channels	3
(l2) Primary Cable Length	3 m		

Article Price
840286  **€ 519.95**



Accessories

- 930445** Profile for D Flex Line MINI  **€ 10.95**
- 930446** Profile for D Flex Line MINI  **€ 14.94**
- 930531** Mounting set for D Flex Line 10,0 x 10,0 mm  **€ 10.95**
- 930593** Gel glue for gluing end caps, 3g  **€ 5.95**

NEON 24V-10W RGBW D FLEX LINE TOP-VIEW IP68

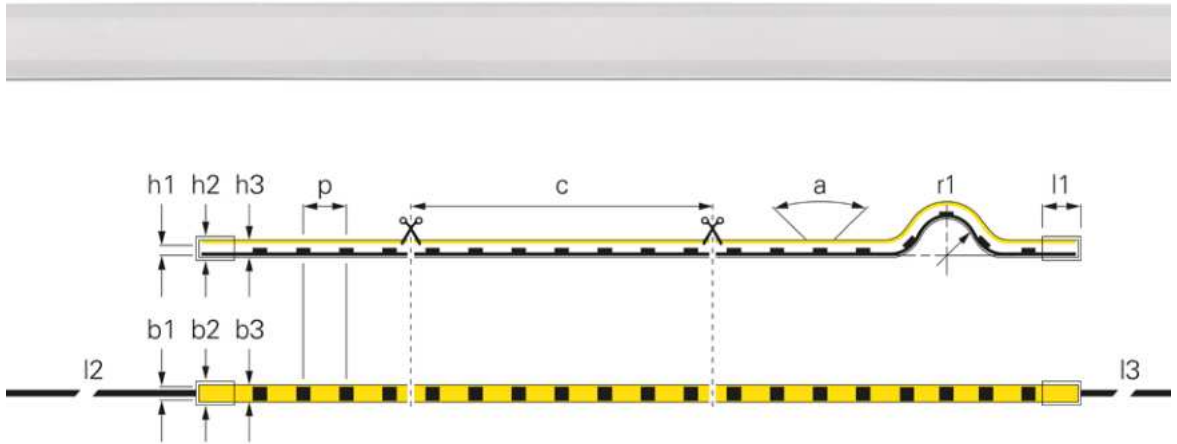



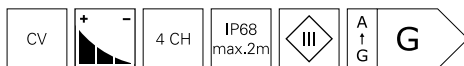

- spot-free homogeneous illumination
- very easy installation using adapted profile
- UV and salt water-resistant IP68
- ultra-flexible and therefore very versatile
- light-fast polyurethane encapsulation

(p) LED Distance	11.91 mm	Colour Temperature	3200 K
(c) Segment Length	166.66 mm	Luminous Efficiency 1m	30.48 lm/W
(a) Light Beam Angle	117 Degree	Luminous Flux 1m	320 lm
(r1) Bending Radius min.	150 mm	Length	5000 mm
(h1) Height	15 mm	Rated Input 1m	10.5W
(h2) Height End Cap	18 mm	Rated Input Voltage	24 V/DC
(h3) Length Hose	15 mm	Colour Rendering Index (Ra)	80
(b1) Width	16 mm	Control	Dimmable via optional controller
(b2) Width end cap	18 mm	Type of IP Protection	PVC cover
(b3) Width hose	16 mm	Working Temperature	-25 to 45 °C
(l1) Length End Cap	8 mm	Channels	4
(l2) Primary Cable Length	3 m		
(l3) Secondary Cable Length	3 m		

Article Price

840289  € 779.95

Accessories

930448	Profile for D Flex Line TOP		€ 14.94
930449	Profile for D Flex Line TOP		€ 11.95
930533	Mounting set for D Flex Line 16,0 x 15,0 mm		€ 10.95
930593	Gel glue for gluing end caps, 3g		€ 5.95

NEON 24V-8W OMNIFLEX MINI IP67

The OMNIFLEX 24 V 8W IP67 LED strip is available in three different light colors [2,700 K, 3,000 K, 4,000 K]. With a length of 5 meters, it enables flexible use in different areas. Uniform illumination is guaranteed thanks to the point-free light distribution. The very small bending radii in all directions allow a great deal of design freedom when creating shapes. Straight lines are also no problem. All variants are possible thanks to the extensive range of accessories. With a primary and secondary feed of 300 cm each, flexible installation is guaranteed. Thanks to its salt water and UV resistance and IP67 protection rating, the OMNIFLEX LED strip is also ideal for outdoor use.





NEON 24V-8W OMNIFLEX MINI IP67

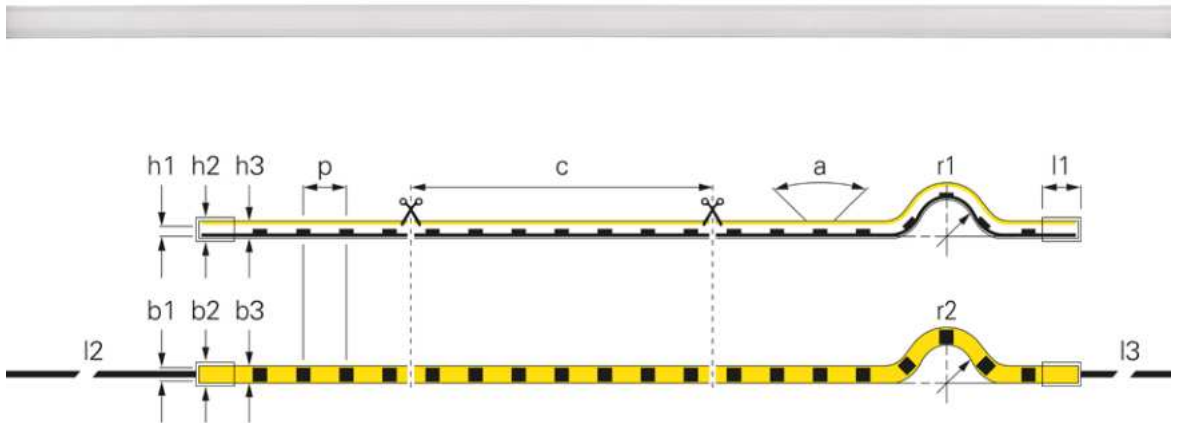

- spot-free light pattern for homogeneous illumination
- Neon effect
- small bending radii in all directions provide a great deal of freedom
- Minimum forward bending radius: 60 mm/to the side: 100 mm
- 300 cm long primary and secondary infeed
- Resistant to salt water and UV rays
- comprehensive range of accessories enables you to shape your design as desired

(p) LED Distance	6.25 mm	(l2) Primary Cable Length	3 m
(c) Segment Length	100 mm	(l3) Secondary Cable Length	3 m
(a) Light Beam Angle	120 Degree	Length	5000 mm
(r1) Bending Radius min.	100 mm	Rated Input 1m	8 W
(r2) Bending Radius Left / Right	60 mm	Rated Input Voltage	24 V/DC
(h1) Height	2 mm	Colour Rendering Index (Ra)	80
(h2) Height End Cap	11 mm	Control	Dimmable via optional controller
(h3) Length Hose	10 mm	Type of IP Protection	Silicone hose
(b1) Width	4.7 mm	Working Temperature	-10 to 55 °C
(b2) Width end cap	11 mm	Channels	1
(b3) Width hose	10 mm		
(l1) Length End Cap	4.5 mm		

Article	Colour Temperature	Luminous Efficiency 1m	Luminous Flux 1m	EEL	Price
840417	2700 K	90 lm/W	720 lm		€ 299.95
840418	3000 K	93 lm/W	744 lm		€ 299.95
840419	4000 K	100 lm/W	800 lm		€ 299.95



48V LED STRIPES

Our new LED stripes in 48V technology offer users numerous advantages. The key advantage: Compared to 12V and 24V stripes, 48V stripes allow longer running lengths. By comparison, conventional LED stripes with lower output voltage require a new feed after only 2.5 metres [single-sided feed] or 5 metres [feed from both sides], for continuous operation. LED stripes with 48V can be used up to a length of 25 metres [single-sided feed] or feed] or 50 metres [feed on both sides] - perfect for lighting coves, long corridors and simplified integration into existing installations, that only allow a single-sided feed.

Advantages of 48V LED stripes

- 48V = lower current
- 48V = longer running length
- 48V = thinner wire cross-sections
- 48V = faster installation
- 48V = more versatile applications
- 48V = lower brightness drop

In addition to the advantages mentioned above, our new 48V LED stripes have a very long service life of up to 75,000h for L70B50 and 50,000h for L80B10. Thanks to reel-to-reel production, the 48V LED stripes have no soldered joints. As we have set ourselves the goal to become climate-neutral, the LED stripes are packaged in an environmentally friendly paper-based packaging.

In addition to the new 48V LED stripes, we of course also offer accessories in the form of power supply units and controllers for the relevant control protocols [RF, DALI, KNX etc.] in order to cover all potential future applications for 48V stripes.



SMD 48V-4W LONG RUN IP20

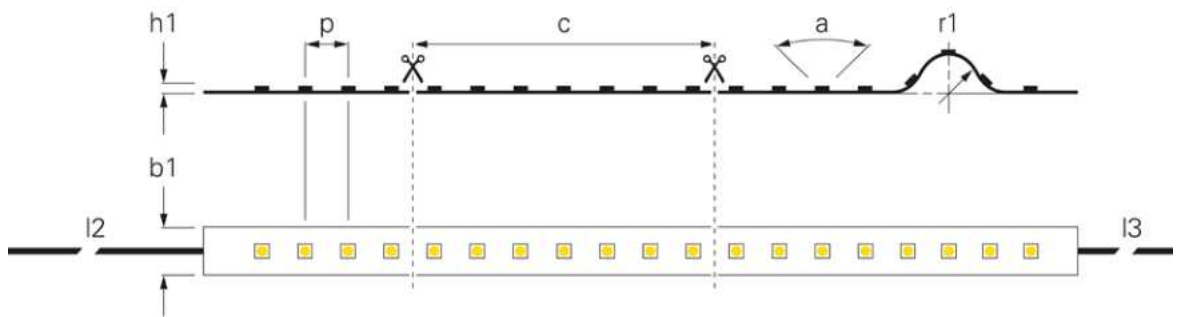

(p) LED Distance	12.82 mm	Rated Input 1m	4 W
(a) Light Beam Angle	120 Degree	Rated Input Voltage	48 V/DC
(r1) Bending Radius min.	50 mm	Colour Rendering Index (Ra)	80
(h1) Height	1 mm	Control	Dimmable via optional controller
(b1) Width	10 mm	Working Temperature	-15 to 50 °C
(I2) Primary Cable Length	1 m	Channels	1
(I3) Secondary Cable Length	1 m		

Article	Colour Temperature	(c) Segment Length	Luminous Efficiency 1m	Luminous Flux 1m	Length	Price
840318	WW 3000 K	25 mm	121 lm/W	485 lm	15000 mm	€ 289.95
840337	WW 3000 K	100 mm	121 lm/W	485 lm	50000 mm	€ 999.95
840320	NW 4000 K	25 mm	133 lm/W	530 lm	15000 mm	€ 289.95
840339	NW 4000 K	100 mm	133 lm/W	530 lm	50000 mm	€ 999.95

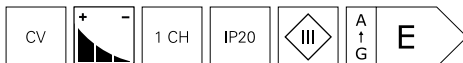
**Lighting design**

Interested in our lighting design service?

Your contact person will be happy to answer any questions you may have.



SMD 48V-4W LONG RUN IP44

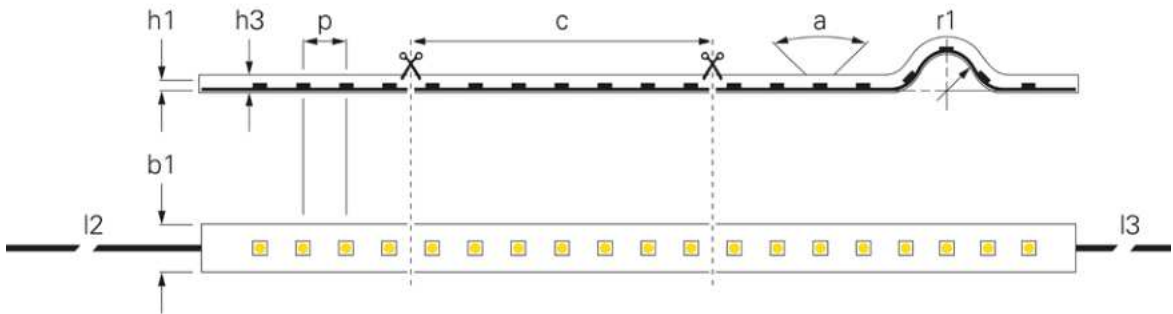

(p) LED Distance	12.82 mm	(I3) Secondary Cable Length	1 m
(a) Light Beam Angle	120 Degree	Rated Input 1m	4 W
(r1) Bending Radius min.	50 mm	Rated Input Voltage	48 V/DC
(h1) Height	1 mm	Colour Rendering Index (Ra)	80
(h3) Length Hose	2 mm	Control	Dimmable via optional controller
(b1) Width	10 mm	Type of IP Protection	Silicone
(b3) Width hose	12 mm	Channels	1
(I2) Primary Cable Length	1 m		

Article	Colour Temperature	(c) Segment Length	Luminous Efficiency 1m	Luminous Flux 1m	Length	Price
840317	WW 3000 K	25 mm	100 lm/W	400 lm	15000 mm	€ 349.95
840338	WW 3000 K	100 mm	100 lm/W	400 lm	50000 mm	€ 1124.95
840319	NW 4000 K	25 mm	114 lm/W	455 lm	15000 mm	€ 349.95
840340	NW 4000 K	100 mm	114 lm/W	455 lm	50000 mm	€ 1124.95

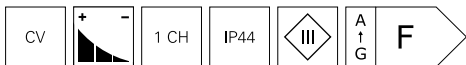

Aluminium profiles

In the »Aluminum profiles« section you will find the right profile for every application with various covers and installation options.

SMD 48V-10W LONG RUN IP20

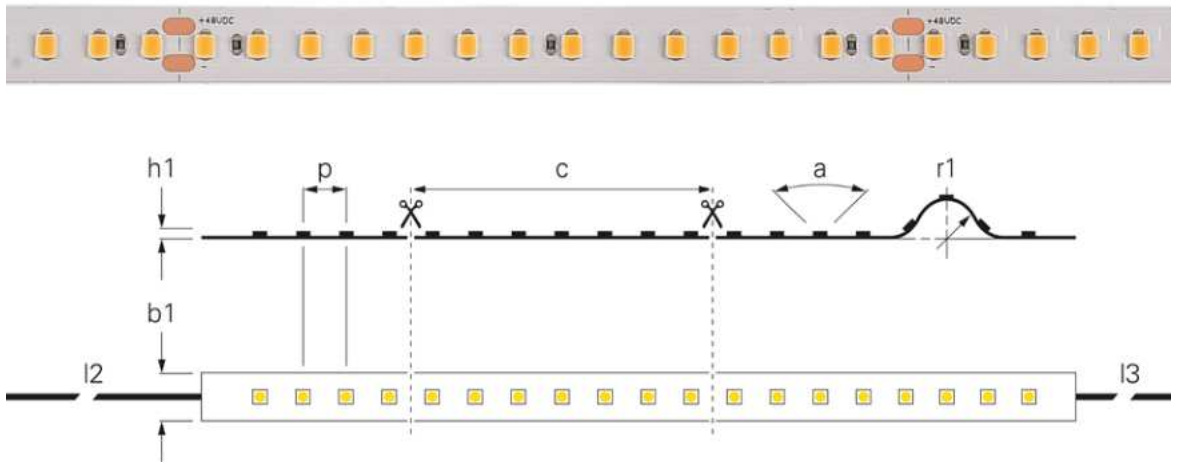

(p) LED Distance	7.14 mm	(l3) Secondary Cable Length	1 m
(c) Segment Length	100 mm	Rated Input 1m	10 W
(a) Light Beam Angle	120 Degree	Rated Input Voltage	48 V/DC
(r1) Bending Radius min.	50 mm	Control	Dimmable via optional controller
(h1) Height	2 mm	Working Temperature	-10 to 55 °C
(b1) Width	10 mm		
(l2) Primary Cable Length	1 m		

Article	Colour Temperature	Luminous Flux 1m	Length	Colour Rendering Index (Ra)	Channels	EEL	Price
840399	RGB	510 lm	15000 mm	65	3		€ 449.95
840407	RGB	510 lm	50000 mm	65	3		€ 1499.95
840393	WW 2700 K	1210 lm	15000 mm	90	1		€ 399.95
840401	WW 2700 K	1210 lm	50000 mm	90	1		€ 1299.95
840394	WW 3000 K	1240 lm	15000 mm	90	1		€ 399.95
840402	WW 3000 K	1240 lm	50000 mm	90	1		€ 1299.95
840395	NW 4000 K	1300 lm	15000 mm	90	1		€ 399.95
840403	NW 4000 K	1300 lm	50000 mm	90	1		€ 1299.95

**Power supply units**

You can find the right power supply unit in various designs and with the required voltage and power in the »Power supply units« section.



SMD 48V-10W LONG RUN IP67

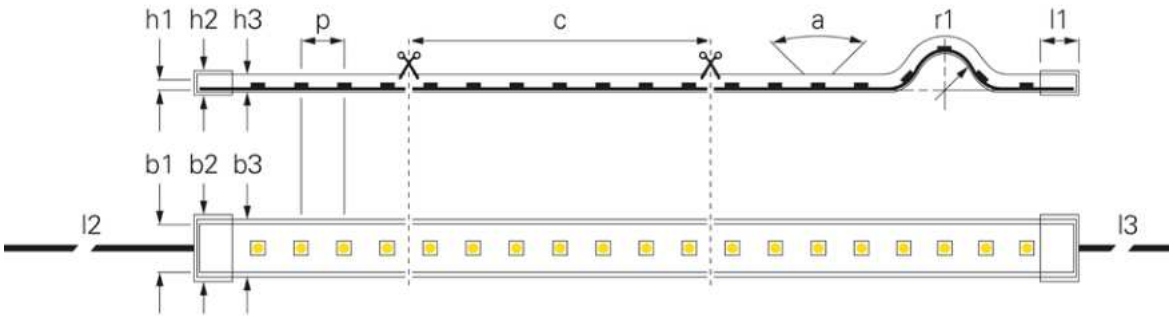

- Ideal for covered lighting and long running lengths
- Up to 50 m in single section with single-/double-sided infeed
- Powerful adhesive tape 3M 300 LSE (IP20)/3M VHB 5604A with primer pre-treatment (IP67)

(p) LED Distance	7.14 mm	(l1) Length End Cap	10 mm
(c) Segment Length	100 mm	(l2) Primary Cable Length	1 m
(a) Light Beam Angle	120 Degree	(l3) Secondary Cable Length	1 m
(r1) Bending Radius min.	50 mm	Rated Input 1m	10 W
(h1) Height	1,7 mm	Rated Input Voltage	48 V/DC
(h2) Height End Cap	6.5 mm	Control	Dimmable via optional controller
(h3) Length Hose	5 mm	Type of IP Protection	Silicone hose
(b1) Width	10 mm	Working Temperature	-10 to 55 °C
(b2) Width end cap	14.2 mm		
(b3) Width hose	12 mm		

Article	Colour Temperature	Luminous Flux 1m	Length	Colour Rendering Index (Ra)	Channels	EEL	Price
840400	RGB	450 lm	15000 mm	65	3		€ 524.95
840408	RGB	450 lm	50000 mm	65	3		€ 1749.95
840396	WW 2700 K	1090 lm	15000 mm	90	1		€ 474.95
840404	WW 2700 K	1090 lm	50000 mm	90	1		€ 1549.95
840397	WW 3000 K	1120 lm	15000 mm	90	1		€ 474.95
840405	WW 3000 K	1120 lm	50000 mm	90	1		€ 1549.95
840398	NW 4000 K	1180 lm	15000 mm	90	1		€ 474.95
840406	NW 4000 K	1180 lm	50000 mm	90	1		€ 1549.95



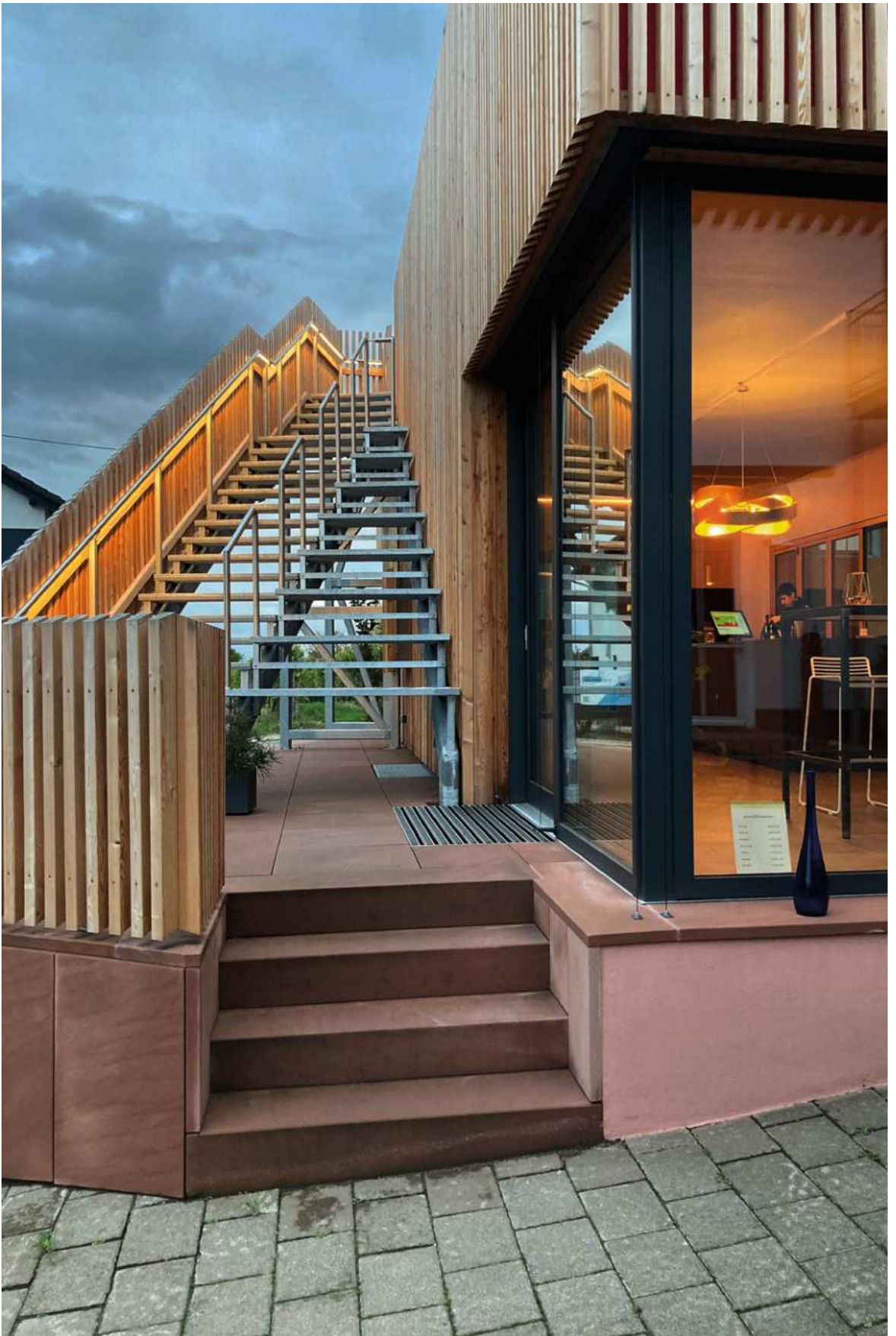

230V LED STRIPES

This LED stripe is ideally suited if the requirements and focus are on flexible, water-protected and long-lasting lighting routes in indoor and outdoor areas.

Due to the voltage of 230V, no additional power supply unit is required. The delivery is ready for connection with mounted Schuko plug and moulded endcap.

The LED stripe can be dimmed from 100% to 40% by a phase on/phase off dimmer to suit the requirement or ambient lighting.

Applications of large distances, such as on buildings or hotel corridors can be operated in one piece up to 50m.





SMD 230V-14W LONG RUN IP65

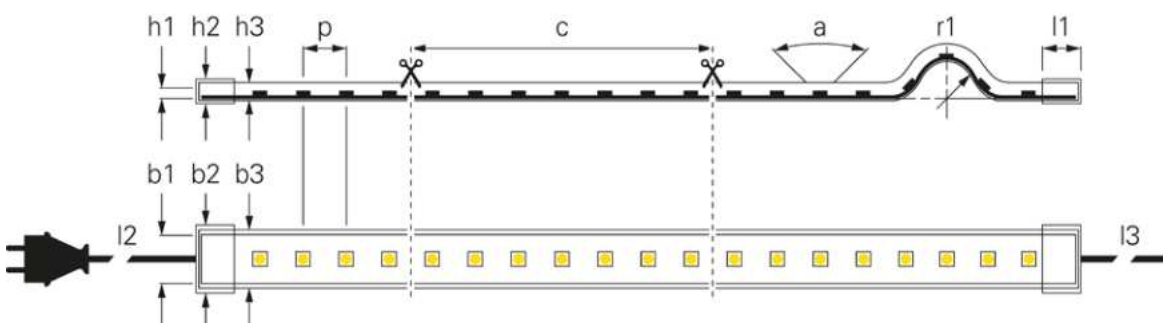

- 230V direct connection
- ready for connection with IP 44 contour plug and end cap
- Total length to be operated up to 50 m

(p) LED Distance	11.9 mm	(I3) Secondary Cable Length	3 m
(a) Light Beam Angle	120 Degree	Rated Input 1m	14 W
(r1) Bending Radius min.	150 mm	Rated Input Voltage	220-240 V/AC
(h1) Height	7.8 mm	Colour Rendering Index (Ra)	80
(h2) Height End Cap	18 mm	Control	Leading-edge dimmer, Trailing-edge dimmer
(h3) Length Hose	13.2 mm	Type of IP Protection	PVC cover
(b1) Width	17 mm	IP Protection Type Plug	IP 44
(b2) Width end cap	21,8 mm	Working Temperature	-10 to 60 °C
(b3) Width hose	17 mm	Channels	1
(I1) Length End Cap	18 mm		
(I2) Primary Cable Length	3 m		

Article	Colour Temperature	(c) Segment Length	Luminous Efficiency 1m	Luminous Flux 1m	Length	EEL	Price
840390	WW 2700 K	170 mm	103 lm/W	1442 lm	15000 mm		€ 769.95
840391	WW 2700 K	170 mm	103 lm/W	1442 lm	50000 mm		€ 2499.95
840386	WW 3000 K	166.66 mm	105 lm/W	1470 lm	15000 mm		€ 769.95
840387	WW 3000 K	166.66 mm	105 lm/W	1470 lm	50000 mm		€ 2499.95
840388	NW 4000 K	170 mm	114 lm/W	1596 lm	15000 mm		€ 769.95
840389	NW 4000 K	170 mm	114 lm/W	1596 lm	50000 mm		€ 2499.95





POWER SUPPLIES

- 768 power supplies | overview
- 770 technical information
- 772 DC | CV | quick finder
- 776 DC | CV
- 790 DC | CC | quick finder
- 793 DC | CC
- 804 AC | CV | quick finder
- 805 AC | CV

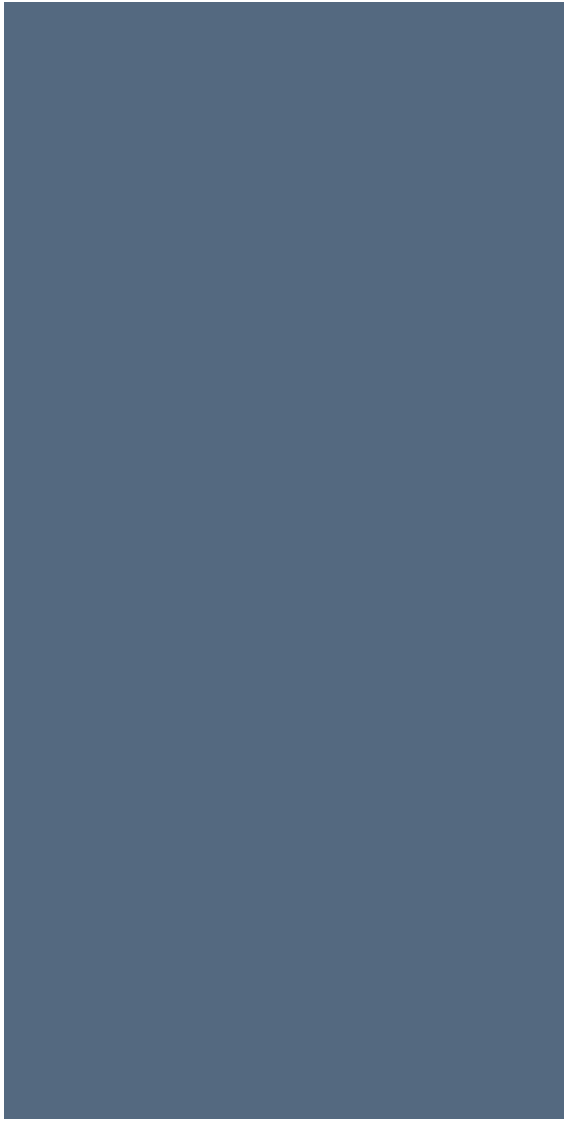

power supplies



■ page 776



■ page 776



■ page 777



□ ■ page 778



■ page 779



■ page 780



■ page 781



■ page 782



■ page 783



■ page 784



■ page 785



■ □ page 786



page 787



page 788



page 788



page 789



page 793



page 793



page 794



page 794



page 795



page 795



page 796



page 797



page 798



page 799



page 799



page 801



page 802



page 803



page 805



page 806



page 807

PLANNING ELECTRICAL INSTALLATIONS EVEN BETTER

You will certainly notice the new technical data when browsing through our power supplies and ask yourself what it is all about? In future, we would like to support you even better in the planning and dimensioning of your installations. The background to this is that more and more power supplies for lighting are already being installed in standard buildings [directly in the luminaires or as an external power supply].

Due to the inrush currents inherent in the design, e.g. after a power failure and the subsequent simultaneous start of all power supplies, an overload of the circuit breakers may occur. In order to be able to take this into account during the planning stage, we provide you with the necessary data for all our power supplies.

WIRE CROSS SECTION

When installing voltage-stable [CV] or current-stable [CC] power supply units and associated components, always ensure that the cable cross-sections are sufficiently dimensioned, especially with regard to the dependence of the cable length.

The specified cable cross-sections [mm²] were adapted to the commercially available cross-sections. The maximum cable length of 10 m should not be exceeded. »Red values« must be avoided urgently.

12 V	2 m	5 m	10 m	12 m
25 W	0,25	0,75	1,50	[2,50]
50 W	0,75	1,50	4,00	[4,00]
75 W	1,00	2,50	4,00	[6,00]
100 W	1,50	4,00	6,00	[10,00]
125 W	1,50	4,00	10,00	[10,00]
150 W	2,50	6,00	10,00	-
200 W	2,50	6,00	-	-
300 W	4,00	10,00	-	-
400 W	6,00	-	-	-

24 V	2 m	5 m	10 m	12 m
25 W	0,25	0,25	0,50	[0,50]
50 W	0,25	0,50	0,75	[1,00]
75 W	0,25	0,75	1,00	[1,50]
100 W	0,50	0,75	1,50	[2,50]
125 W	0,50	1,00	2,50	[2,50]
150 W	0,50	1,50	2,50	[4,00]
200 W	0,75	1,50	4,00	[4,00]
300 W	1,00	2,50	6,00	-
400 W	1,50	4,00	6,00	-

48 V	2 m	5 m	10 m	12 m
25 W	0,25	0,25	0,25	[0,25]
50 W	0,25	0,25	0,25	[0,25]
75 W	0,25	0,25	0,50	[0,50]
100 W	0,25	0,25	0,50	[0,50]
125 W	0,25	0,25	0,50	[0,75]
150 W	0,25	0,50	0,75	[0,75]
200 W	0,25	0,50	1,00	[1,00]
300 W	0,25	0,75	1,50	[1,50]
400 W	0,50	1,00	2,50	[2,50]

HOW MANY POWER SUPPLY UNITS PER CIRCUIT BREAKER?

The maximum number of power supply units that may be connected to the respective circuit breaker is directly dependent on the inrush current. In our quick finders you will find the number for the most common types of circuit breaker [B10A, B16A, C10A, C16A].

CAPACITIVE LOAD OF POWER SUPPLIES

Due to their design, power supplies sometimes represent very different capacitive loads. Especially in combination with motion detectors, twilight switches or switching/dimming actuators, this value [as with the capacitor in nF/pF], which is available for many power supplies and specified in our quick finders, plays an important role with regard to the suitability and durability of all components. Please also refer to the manufacturer's data sheets.

electr. data		dimmable via							usage / design			electrical limit values		power supply	
voltage	power	leading edge / cut-off	1 - 10V	touch dimmer [push]	DMX	DALI	KNX	CASAMBI-App	indoor	outdoor	design	capacitive load	max. quantity per automatic circuit breaker	item number	page
		x													
12V	20 W								x		flat	938uF	B10A=17, B16A=27, C10A=36, C16A=58	862232	729
12V	2,5-25 W	x							x		basic	31.16nF	B10=35, B16=56, C10=35, C16=56	862240	733
12V	40 W								x		basic	251.7nF	B10A=11, B16A=18, C10A=24, C16A=39	862162	730

DO YOU KNOW OUR LONG-FLAT POWER SUPPLIES?

These power supply units are now available with a power of up to 240 watts and due to their compact dimensions, they are ideally suited for installation in ceiling coves, shadow gaps or all other installation situations with little space.

All Long-Flat power supplies can be found on page 784.



electr. data		dimmable via						usage / design			electrical limit values		power supply	
voltage	power	leading cut-off 1 - 10V	touch dimmer [push]	DMX	DALI	KNX	indoor	outdoor	design	capacitive load	max. quantity per automatic circuit breaker	item number	page	
12V	4 W						x	x	mini		B10A=17, B16A=28, C10A=37, C16A=59	872127	776	
12V	6 W						x		flat	38.83nF	B10A=17, B16A=28, C10A=37, C16A=59	872629	777	
12V	12 W						x	x	octo	101uF	B10A=17, B16A=27, C10A=36, C16A=58	862229	776	
12V	12 W						x		flat		B10A=17, B16A=27, C10A=36, C16A=58	862231	777	
12V	20 W						x		flat	938uF	B10A=17, B16A=27, C10A=36, C16A=58	862232	777	
12V	2,5- 25 W	x					x		basic	31.16nF	B10=35, B16=56, C10=35, C16=56	862240	785	
12V	40 W						x		basic	251.7nF	B10A=11, B16A=18, C10A=24, C16A=39	862162	779	
12V	40 W						x	x	IP	621.5nF	B10A=5, B16A=9, C10A=12, C16A=19	872082	780	
12V	40 W						x	x	IP		B10A=6, B16A=9, C10A=10, C16A=16	872097	781	
12V	40 W		x	x		x	x		basic		B10A=18, B16A=28, C10A=36, C16A=56	862253	787	
12V	45 W						x		long-flat	462.1nF	B10A=5, B16A=9, C10A=12, C16A=19	862123	778	
12V	50 W						x		flat	485.5nF	B10A=11, B16A=18, C10A=24, C16A=39	862121	777	
12V	12- 50 W	x					x		basic	1924uF	B10A=17, B16A=28, C10A=17, C16A=28	862220	785	
12V	60 W						x		long-flat	462.1nF	B10A=5, B16A=9, C10A=12, C16A=19	862093	778	
12V	60 W						x	x	IP		B10A=6, B16A=9, C10A=10, C16A=16	872098	781	
12V	60 W					x	x	x	IP		B10A=6, B16A=9, C10A=10, C16A=16	872109	788	
12V	75 W						x		basic	870nF	B10A=11, B16A=18, C10A=24, C16A=39	862127	779	
12V	75 W						x	x	IP	621.5nF	B10A=5, B16A=8, C10A=10, C16A=16	872084	780	
12V	75 W		x	x		x	x		basic		B10A=10, B16A=16, C10A=20, C16A=32	862254	787	
12V	90 W						x	x	IP		B10A=2, B16A=3, C10A=3, C16A=6	872099	781	
12V	100 W						x		basic	842.2nF	B10A=3, B16A=5, C10A=7, C16A=11	862165	779	
12V	100 W						x	x	IP	621.5nF	B10A=3, B16A=5, C10A=7, C16A=11	872093	780	
12V	100 W						x		long-flat	462.1nF	B10A=3, B16A=5, C10A=7, C16A=11	862125	778	
12V	33- 100 W	x					x	x	IP	93,14nF	B10=7, B16=15, C10=7, C16=15	872135	786	
12V	34- 100 W	x					x		basic	146,34nF	B10=7, B16=15, C10=7, C16=15	862241	785	
12V	120 W						x	x	IP		B10A=2, B16A=4, C10A=4, C16A=6	872100	781	

electr. data		dimmable via						usage / design			electrical limit values		power supply	
voltage	power	leading cut-off	1 - 10V	touch dimmer [push]	DMX	DALI	KNX	indoor	outdoor	design	capacitive load	max. quantity per automatic circuit breaker	item number	page
12V	120 W						x	x		IP		B10A=2, B16A=4, C10A=4, C16A=6	872110	788
12V	135 W				x			x		*		B10A=7, B16A=12, C10A=16, C16A=25	843274	789
12V	150 W							x		long-flat	462.1nF	B10A=3, B16A=5, C10A=6, C16A=10	862172	778
12V	150 W							x		basic	591.2nF	B10A=2, B16A=4, C10A=6, C16A=9	862167	779
12V	150 W							x	x	IP	621.5nF	B10A=2, B16A=4, C10A=6, C16A=9	872086	780
12V	66-200 W	x						x	x	IP	148,64nF	B10=3, B16=7, C10=3, C16=7	872137	786
12V	200 W							x	x	IP	621.5nF	B10A=2, B16A=3, C10A=4, C16A=7	872088	780
12V	200 W						x	x		IP		B10A=2, B16A=4, C10A=4, C16A=6	872111	788
24V	4 W							x	x	mini		B10A=59, B16A=94, C10A=123, C16A=197	872128	776
24V	6 W							x		flat	43.5nF	B10A=17, B16A=28, C10A=37, C16A=59	872630	777
24V	12 W							x	x	octo	620uF	B10A=17, B16A=27, C10A=36, C16A=58	862230	776
24V	12 W							x		flat	311uF	B10A=17, B16A=27, C10A=36, C16A=58	862233	777
24V	20 W							x		flat	446uF	B10A=17, B16A=27, C10A=36, C16A=58	862234	777
24V	2,5-25 W	x						x		basic	9520uF	B10=35, B16=56, C10=35, C16=56	862221	785
24V	40 W							x		basic	762nF	B10A=11, B16A=18, C10A=24, C16A=39	862163	779
24V	40 W							x	x	IP	626.3nF	B10A=5, B16A=9, C10A=12, C16A=19	872083	780
24V	40 W							x	x	IP		B10A=6, B16A=9, C10A=10, C16A=16	872101	781
24V	40 W		x	x		x		x		basic		B10A=18, B16A=28, C10A=36, C16A=56	862255	787
24V	45 W							x		long-flat	451.2nF	B10A=5, B16A=9, C10A=12, C16A=19	862124	778
24V	12-50 W	x						x		basic	10520uF	B10A=17, B16A=28, C10A=17, C16A=28	862222	785
24V	50 W							x		flat	604.5nF	B10A=11, B16A=18, C10A=24, C16A=39	862122	777
24V	60 W							x		long-flat	451.2nF	B10A=5, B16A=9, C10A=12, C16A=19	862094	778
24V	60 W							x	x	IP		B10A=6, B16A=9, C10A=10, C16A=16	872102	781
24V	60 W						x	x		IP		B10A=6, B16A=9, C10A=10, C16A=16	872112	788
24V	12-60 W	x						x	x	*			872045	783
24V	75 W							x		basic	760nF	B10A=11, B16A=18, C10A=24, C16A=39	862164	779

electr. data		dimmable via						usage / design			electrical limit values		power supply	
voltage	power	leading cut-off		touch dimmer [push]	DMX	DALI	KNX	indoor	outdoor	design	capacitive load	max. quantity per automatic circuit breaker	item number	page
		1 - 10V												
24V	75 W							x	x	IP	626.3nF	B10A=5, B16A=8, C10A=10, C16A=16	872085	780
24V	75 W		x	x		x		x		basic		B10A=10, B16A=16, C10A=20, C16A=32	862256	787
24V	90 W							x	x	IP		B10A=2, B16A=3, C10A=3, C16A=6	872103	781
24V	100 W							x		basic	724.2nF	B10A=3, B16A=5, C10A=7, C16A=11	862166	779
24V	33-100 W	x						x		IP	94, 13nF	B10=7, B16=15, C10=7, C16=15	872136	786
24V	34-100 W	x						x		basic	140.74nF	B10=7, B16=15, C10=7, C16=15	862242	785
24V	100 W							x		long-flat	451.2nF	B10A=3, B16A=5, C10A=7, C16A=11	862126	778
24V	100 W							x	x	IP	626.3nF	B10A=3, B16A=5, C10A=7, C16A=11	872094	780
24V	120 W							x	x	IP		B10A=2, B16A=4, C10A=4, C16A=6	872104	781
24V	120 W						x	x	x	IP		B10A=2, B16A=4, C10A=4, C16A=6	872113	788
24V	135 W				x			x		*		B10A=7, B16A=12, C10A=16, C16A=25	843275	789
24V	150 W							x		basic	591.2nF	B10A=2, B16A=4, C10A=6, C16A=9	862168	779
24V	150 W							x		long-flat	451.2nF	B10A=3, B16A=5, C10A=6, C16A=10	862173	778
24V	150 W							x	x	IP	626.3nF	B10A=2, B16A=4, C10A=6, C16A=9	872087	780
24V	30-150 W	x						x	x	*			872046	783
24V	50-150 W	x						x		long-flat		B10A=2, B16A=3, C10A=4, C16A=7	862268	784
24V	150 W		x	x		x		x		basic		B10A=5, B16A=9, C10A=10, C16A=18	862262	787
24V	200 W						x	x		IP		B10A=2, B16A=4, C10A=4, C16A=6	872114	788
24V	66-200 W	x						x	x	IP	148.64nF	B10=3, B16=7, C10=3, C16=7	872138	786
24V	240 W							x	x	IP	626.3nF	B10A=2, B16A=3, C10A=4, C16A=7	872089	780
24V	240 W							x		long-flat	5600uF	B10A=1, B16A=2, C10A=3, C16A=5	862265	778
24V	240 W		x			x		x		basic		B10A=3, B16A=5, C10A=6, C16A=10	862263	787
24V	320 W							x	x	IP	626.3nF	B10A=2, B16A=3, C10A=4, C16A=6	872091	780
48V	40 W							x	x	IP		B10A=6, B16A=9, C10A=10, C16A=16	872105	781
48V	60 W							x	x	IP		B10A=6, B16A=9, C10A=10, C16A=16	872106	781
48V	75 W		x	x		x		x		basic		B10A=10, B16A=16, C10A=20, C16A=32	862273	787

electr. data		dimmable via						usage / design			electrical limit values		power supply	
voltage	power	leading cut-off		touch dimmer [push]	DMX	DALI	KNX	indoor	outdoor	design	capacitive load	max. quantity per automatic circuit breaker	item number	page
		1 - 10V												
48V	90 W							x	x	IP		B10A=2, B16A=3, C10A=3, C16A=6	872107	781
48V	33-100 W	x						x		IP	6,6uF	B10=3 B16=5, C10=7, C16=11	872142	786
48V	34-100 W	x						x		basic	140,74nF	B10=7 B16=15, C10=7, C16=15	862274	785
48V	100 W							x		long-flat	451.2nF	B10A=3, B16A=5, C10A=7, C16A=11	862270	778
48V	120 W							x	x	IP		B10A=2, B16A=4, C10A=4, C16A=6	872108	781
48V	150 W		x	x		x		x		basic		B10A=5, B16A=9, C10A=10 C16A=18	862275	787
48V	50-150 W	x						x		long-flat		B10A=2, B16A=3, C10A=4, C16A=7	862269	784
48V	150 W							x		long-flat	451.2nF	B10A=3, B16A=5, C10A=6, C16A=10	862271	778
48V	320 W							x	x	IP	626.3nF	B10A=2, B16A=3, C10A=4, C16A=6	872145	780
48V	66-200 W	x						x	x	IP	6,6uF	B10=2, B16=3, C10=4 C16=7	872143	786
48V	200 W						x	x		IP		B10A=2, B16A=4, C10A=4, C16A=6	872115	788
48V	240 W		x	x		x		x		basic		B10A=3, B16A=5, C10A=6, C16A=10	862276	787
48V	240 W							x		long-flat	5600uF	B10A=1, B16A=2, C10A=3, C16A=5	862272	778
48V	600 W							x	x	IP		B10A=1, B16A=1, C10A=1, C16A=2	872125	782
48V	600 W		x					x	x	IP		B10A=1, B16A=1, C10A=1, C16A=2	872126	788

power supplies design

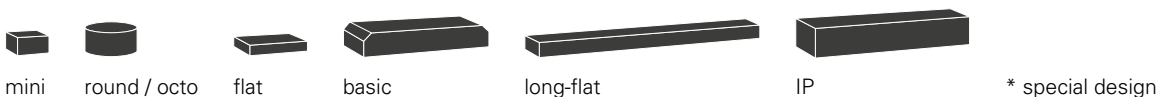



DEKO-LIGHT POWER SUPPLY UNITS CV | MINI DESIGN

- Flicker-free
- Secured against short circuits and overloads

Housing	Polycarbonate	Height	21 mm
Power	4 W	Rated Input Voltage	220-240 V/AC
Length	53 mm	Mounting Location	Inside, Outside
Width	27 mm		

Article		Output Voltage	Output Current	Price
872127	■	12 V/DC	0-330 mA	€ 12.95
872128	■	24 V/DC	0-170 mA	€ 12.95



DEKO-LIGHT POWER SUPPLY UNITS CV IP | OCTO DESIGN

- Flicker-free
- Secured against short circuits and overloads

Housing	Plastic	Height	24 mm
Power	12 W	Rated Input Voltage	220-240 V/AC
Length	50 mm	Mounting Location	Inside, Outside
Width	48 mm		

Article		Output Voltage	Output Current	Price
862229	■	12 V/DC	0-1000 mA	€ 21.95
862230	■	24 V/DC	0-500 mA	€ 21.95





DEKO-LIGHT POWER SUPPLY UNITS CV | FLAT DESIGN

- Ideal for concealed mounting in ceiling coves
- Flicker-free
- Secured against short circuits and overloads
- Overheating protection

Housing Plastic Mounting Location Inside
 Rated Input Voltage 220-240 V/AC

Article	Output Voltage	Power	Output Current	Length	Width	Height	Price
872629 ■	12 V/DC	6.0 W	0-500 mA	98 mm	46 mm	11 mm	€ 16.95
862231 ■	12 V/DC	12.0 W	0-1000 mA	128 mm	50 mm	13 mm	€ 21.95
862232 ■	12 V/DC	20.0 W	0-1670 mA	128 mm	50 mm	13 mm	€ 25.95
862121 ■	12 V/DC	50.0 W	0-4160 mA	185 mm	62 mm	22 mm	€ 52.95
872630 ■	24 V/DC	6.0 W	0-250 mA	98 mm	46 mm	11 mm	€ 16.95
862233 ■	24 V/DC	12.0 W	0-500 mA	128 mm	50 mm	13 mm	€ 21.95
862234 ■	24 V/DC	20.0 W	0-830 mA	128 mm	50 mm	13 mm	€ 25.95
862122 ■	24 V/DC	50.0 W	0-2100 mA	185 mm	62 mm	22 mm	€ 52.95



Lighting design

Interested in our lighting design service?

Your contact person will be happy to answer any questions you may have.



DEKO-LIGHT POWER SUPPLY UNITS CV | LONG-FLAT DESIGN

- Ideal for concealed mounting in ceiling coves
- Flicker-free
- Secured against short circuits and overloads
- Overheating protection

Housing	Plastic	Mounting Location	Inside
Rated Input Voltage	220-240 V/AC		

Article	Output Voltage	Power	Output Current	Length	Width	Height	Price
862123 ■	12 V/DC	45.0 W	0-3750 mA	251 mm	30 mm	16 mm	€ 49.95
862093 □	12 V/DC	60.0 W	0-5000 mA	305 mm	30 mm	17 mm	€ 59.95
862125 ■	12 V/DC	100.0 W	0-8340 mA	312 mm	30 mm	18.2 mm	€ 96.95
862172 ■	12 V/DC	132.0 W	0-11000 mA	335 mm	30 mm	21.6 mm	€ 129.95
862124 ■	24 V/DC	45.0 W	0-1870 mA	251 mm	30 mm	16 mm	€ 49.95
862094 □	24 V/DC	60.0 W	0-2500 mA	305 mm	30 mm	17 mm	€ 59.95
862126 ■	24 V/DC	100.0 W	0-4170 mA	312 mm	30 mm	18.2 mm	€ 96.95
862173 ■	24 V/DC	150.0 W	0-6250 mA	335 mm	30 mm	21.6 mm	€ 129.95
862265 ■	24 V/DC	240.0 W	0-10000 mA	357 mm	32 mm	23 mm	€ 159.95
862270 ■	48 V/DC	100.0 W	0-2080 mA	312 mm	30 mm	18.2 mm	€ 96.95
862271 ■	48 V/DC	150.0 W	0-3125 mA	335 mm	30 mm	21.6 mm	€ 129.95
862272 ■	48 V/DC	240.0 W	0-5000 mA	357 mm	32 mm	22.5 mm	€ 159.95





DEKO-LIGHT POWER SUPPLY UNITS CV | BASIC DESIGN

- Flicker-free
- Secured against short circuits and overloads
- Overheating protection

Housing Plastic Mounting Location Inside
 Rated Input Voltage 220-240 V/AC

Article	Output Voltage	Power	Output Current	Length	Width	Height	Price
862162	12 V/DC	40.0 W	0-3300 mA	166 mm	52 mm	24 mm	€ 46.95
862127	12 V/DC	75.0 W	0-6300 mA	184 mm	61 mm	32 mm	€ 74.95
862165	12 V/DC	100.0 W	0-8300 mA	184 mm	61 mm	32 mm	€ 96.95
862167	12 V/DC	150.0 W	0-12500 mA	210 mm	67 mm	34 mm	€ 129.95
862163	24 V/DC	40.0 W	0-1700 mA	166 mm	52 mm	24 mm	€ 46.95
862164	24 V/DC	75.0 W	0-3100 mA	184 mm	61 mm	32 mm	€ 74.95
862166	24 V/DC	100.0 W	0-4200 mA	184 mm	61 mm	32 mm	€ 96.95
862168	24 V/DC	150.0 W	0-6250 mA	210 mm	67 mm	34 mm	€ 129.95



Technical data sheet













New in the onlineshop: The technical data sheets offer even more information: Light and energy data, light distribution curves, dimensional drawings and more.



DEKO-LIGHT POWER SUPPLY UNITS CV IP | IP DESIGN

- Robust housing
- Flicker-free
- Secured against short circuits and overloads
- Overheating protection

Housing Aluminium Mounting Location Inside, Outside
 Rated Input Voltage 100-240 V/AC

Article	Output Voltage	Power	Output Current	Length	Width	Height	Price
872082 	12 V/DC	40.0 W	0-3340 mA	176 mm	58 mm	30.5 mm	€ 74.95
872084 	12 V/DC	75.0 W	0-6250 mA	186 mm	64 mm	39 mm	€ 94.95
872093 	12 V/DC	100.0 W	0-8340 mA	186 mm	64 mm	39 mm	€ 114.95
872086 	12 V/DC	150.0 W	0-12500 mA	191 mm	70 mm	40 mm	€ 149.95
872088 	12 V/DC	200.0 W	0-16670 mA	249 mm	72 mm	41 mm	€ 179.95
872083 	24 V/DC	40.0 W	0-1670 mA	176 mm	58 mm	30.5 mm	€ 74.95
872085 	24 V/DC	75.0 W	0-3125 mA	186 mm	64 mm	39 mm	€ 94.95
872094 	24 V/DC	100.0 W	0-4170 mA	186 mm	64 mm	39 mm	€ 114.95
872087 	24 V/DC	150.0 W	0-6250 mA	191 mm	70 mm	40 mm	€ 149.95
872089 	24 V/DC	240.0 W	0-10000 mA	249 mm	72 mm	40 mm	€ 184.95
872091 	24 V/DC	320.0 W	0-13340 mA	252 mm	90 mm	44 mm	€ 219.95
872145 	48 V/DC	320.0 W	0-6660 mA	252 mm	90 mm	44 mm	€ 219.95





MEANWELL POWER SUPPLY UNITS CV IP | NPF SERIES

- Flicker-free
- Secured against short circuits and overloads
- Overheating protection
- Robust housing

Housing	Plastic	Mounting Location	Inside, Outside
Rated Input Voltage	90-305 V/AC		

Article	Output Voltage	Power	Output Current	Length	Width	Height	Price
872097 ■	12 V/DC	40.0 W	0-3340 mA	150 mm	53 mm	35 mm	€ 84.95
872098 ■	12 V/DC	60.0 W	0-5000 mA	150 mm	53 mm	35 mm	€ 94.95
872099 ■	12 V/DC	90.0 W	0-7500 mA	171 mm	63 mm	37.5 mm	€ 119.95
872100 ■	12 V/DC	120.0 W	0-10000 mA	191 mm	63 mm	37.5 mm	€ 139.95
872101 ■	24 V/DC	40.0 W	0-1670 mA	150 mm	53 mm	35 mm	€ 84.95
872102 ■	24 V/DC	60.0 W	0-2500 mA	150 mm	53 mm	35 mm	€ 94.95
872103 ■	24 V/DC	90.0 W	0-3750 mA	171 mm	63 mm	37.5 mm	€ 119.95
872104 ■	24 V/DC	120.0 W	0-5000 mA	191 mm	63 mm	37.5 mm	€ 139.95
872105 ■	48 V/DC	40.0 W	0-840 mA	150 mm	53 mm	35 mm	€ 84.95
872106 ■	48 V/DC	60.0 W	0-1250 mA	150 mm	53 mm	35 mm	€ 94.95
872107 ■	48 V/DC	90.0 W	0-1880 mA	171 mm	63 mm	37.5 mm	€ 119.95
872108 ■	48 V/DC	120.0 W	0-2500 mA	191 mm	63 mm	37.5 mm	€ 139.95





MEANWELL POWER SUPPLY UNITS CV IP | ELG/HLG SERIES

- **Output voltage/current can be adjusted via potentiometer**
- **Flicker-free**
- **Secured against short circuits and overloads**
- **Overheating protection**

Housing	Aluminium	Width	144 mm
Output Voltage	48 V/DC	Height	48.5 mm
Power	600 W	Rated Input Voltage	90-305 V/AC
Output Current	0-12500 mA	Mounting Location	Inside, Outside
Length	280 mm		

Article Price

872125  **€ 489.95**





ABN LED SAFETY TRANSFORMER CV DIM IP

- Safety transformer [DC] in accordance with DIN 2006-7 EN 61558-2-6: 2010-04
- Reinforced and double insulation [separate primary and secondary winding]
- additional insulating plastic parts
- more stringent test conditions
- Suitable for applications in the area of increased personal protection according to DIN EN 61558 for the operation of luminaires in swimming pools, fountains, wet rooms etc.
- Primarily dimmable via leading edge phase control
- Maximum load: 80% output in continuous operation

Housing	Plastic	Channels	1
Output Voltage	24 V/DC	Mounting Location	Inside, Outside
Rated Input Voltage	220-240 V/AC		

Article	Power	Length	Width	Height	Price
872045 ■	12.0-60.0 W	150 mm	90 mm	70 mm	€ 369.95
872046 ■	30.0-150.0 W	176 mm	116 mm	110 mm	€ 599.95





DEKO-LIGHT NETZGERÄTE CV DIM / BAUFORM LONG-FLAT

- can be dimmed using leading-edge/trailing-edge phase dimmers
- ideal for retrofitting existing installations, since it can be dimmed primarily with rotary/push-button dimmers (C-compatible)
- long, compact design
- cannot be combined with PWM dimmers such as RF, DMX, DALI or KNX
- flicker-free
- secured against short circuits and overloads
- Overheating protection

Housing	Polycarbonate	Height	21.6 mm
Power	50.0-150 W	Rated Input Voltage	220-240 V/AC
Length	400 mm	Channels	1
Width	32 mm	Mounting Location	Inside

Article		Output Voltage	Price
862268	■	24 V/DC	€ 129.95
862269	■	48 V/DC	€ 129.95





DEKO-LIGHT POWER SUPPLY UNITS CV DIM | BASIC DESIGN

- Dimmable with leading edge/trailing edge phase dimmers
- Ideal for retrofitting existing installations, as primarily dimmable with rotary/switch dimmers (C-compatible)
- cannot be combined with PWM dimmers such as RF, DMX, DALI, KNX
- Flicker-free
- Short-circuit and overload-proof
- overheating protection

Housing	Plastic	Channels	1
Rated Input Voltage	220-240 V/AC	Mounting Location	Inside

Article	Output Voltage	Power	Length	Width	Height	Price
862240 ■	12 V/DC	2.5-25.0 W	122 mm	52 mm	30 mm	€ 54.95
862220 ■	12 V/DC	12.0-50.0 W	184 mm	61 mm	33 mm	€ 74.95
862241 ■	12 V/DC	34.0-100.0 W	210 mm	67 mm	34 mm	€ 144.95
862221 ■	24 V/DC	2.5-25.0 W	122 mm	52 mm	30 mm	€ 54.95
862222 ■	24 V/DC	12.0-50.0 W	184 mm	61 mm	33 mm	€ 74.95
862242 ■	24 V/DC	34.0-100.0 W	210 mm	67 mm	34 mm	€ 144.95
862274 ■	48 V/DC	34.0-100.0 W	210 mm	67 mm	34 mm	€ 144.95





DEKO-LIGHT POWER SUPPLY UNITS CV DIM IP | IP DESIGN

- can be dimmed using leading-edge/trailing-edge phase dimmers
- ideal for retrofitting existing installations, since it can be dimmed primarily with rotary/push-button dimmers (C-compatible)
- cannot be combined with PWM dimmers such as RF, DMX, DALI or KNX
- robust housing
- flicker-free
- secured against short circuits and overloads
- Overheating protection

Housing	Aluminium	Channels	1
Height	40 mm	Mounting Location	Inside, Outside
Rated Input Voltage	220-240 V/AC		

Article	Output Voltage	Power	Length	Width	Price
872135 ■	12 V/DC	33.0-100.0 W	191 mm	70 mm	€ 169.95
872137 □	12 V/DC	66.0-200.0 W	249 mm	72 mm	€ 206.95
872136 ■	24 V/DC	33.0-100.0 W	191 mm	70 mm	€ 169.95
872138 □	24 V/DC	66.0-200.0 W	249 mm	72 mm	€ 206.95
872142 □	48 V/DC	33.0-100.0 W	191 mm	70 mm	€ 169.95
872143 □	48 V/DC	66.0-200.0 W	249 mm	72 mm	€ 206.95





DEKO-LIGHT POWER SUPPLY UNITS CV DIM | LCP DALI

- can be dimmed using DALI2/DALI1
- can be dimmed using 0-10 V/1-10 V
- can be dimmed using touch dimmer via 230 V push-button (iPush)
- new Intelli-Push function (button combination synchronises all connected power supply units when needed)
- Power supply unit and PWM dimmer in one device
- secured against short circuits and overloads
- Overheating protection

Housing	Plastic	Channels	1
Rated Input Voltage	220-240 V/AC	Mounting Location	Inside

Article		Output Voltage	Power	Length	Width	Height	Price
862253	<input type="checkbox"/>	12 V/DC	40.0 W	185 mm	42.5 mm	28.5 mm	€ 99.95
862254	<input type="checkbox"/>	12 V/DC	75.0 W	295 mm	40 mm	32 mm	€ 129.95
862255	<input type="checkbox"/>	24 V/DC	40.0 W	185 mm	42.5 mm	28.5 mm	€ 99.95
862256	<input type="checkbox"/>	24 V/DC	75.0 W	295 mm	40 mm	32 mm	€ 129.95
862262	<input type="checkbox"/>	24 V/DC	150.0 W	295 mm	40 mm	32 mm	€ 169.95
862263	<input type="checkbox"/>	24 V/DC	240.0 W	360 mm	40 mm	32 mm	€ 219.95
862273	<input type="checkbox"/>	48 V/DC	75.0 W	295 mm	40 mm	32 mm	€ 129.95
862275	<input type="checkbox"/>	48 V/DC	150.0 W	295 mm	40 mm	32 mm	€ 169.95
862276	<input type="checkbox"/>	48 V/DC	240.0 W	360 mm	40 mm	32 mm	€ 219.95





MEANWELL POWER SUPPLY UNITS CV DIM IP | ELG/HLG SERIES

- can be dimmed using 0-10 V/1-10 V
- flicker-free, secured against short circuits and overloads
- Overheating protection

Housing	Aluminium	Height	48.5 mm
Output Voltage	48 V/DC	Rated Input Voltage	90-305 V/AC
Power	600 W	Channels	1
Length	280 mm	Mounting Location	Inside, Outside
Width	144 mm		

Article Price

872126 **€ 499.95**



MEANWELL POWER SUPPLY UNITS CV DIM | PWM KNX

- can be dimmed using KNX bus
- flicker-free, secured against short circuits and overloads
- Overheating protection

Housing	Plastic	Channels	1
Rated Input Voltage	90-305 V/AC	Mounting Location	Inside

Article	Output Voltage	Power	Length	Width	Height	Price
872109 ■	12 V/DC	60.0 W	150 mm	53 mm	35 mm	€ 159.95
872110 ■	12 V/DC	120.0 W	191 mm	63 mm	37.5 mm	€ 209.95
872111 ■	12 V/DC	200.0 W	195 mm	68 mm	39.5 mm	€ 244.95
872112 ■	24 V/DC	60.0 W	150 mm	53 mm	35 mm	€ 159.95
872113 ■	24 V/DC	120.0 W	191 mm	63 mm	37.5 mm	€ 209.95
872114 ■	24 V/DC	200.0 W	195 mm	68 mm	39.5 mm	€ 244.95
872115 ■	48 V/DC	200.0 W	195 mm	68 mm	39.5 mm	€ 244.95





DEKO-LIGHT POWER SUPPLY UNITS CV DIM | HV DMX 2-IN-1

- Power supply unit + DMX dimmer in one device
- controllable with DMX
- integrated 3-channel DMX PWM dimmer
- suitable for 3x 1-channel single, 1x WW-CW or 1x RGB LED strip
- dimmable from 0 - 100%
- DMX connection via CAT5 pluggable
- Connection: screw terminals
- Short-circuit and overload-proof
- overheating protection

Housing	Metal	Height	40 mm
Power	135 W	Rated Input Voltage	100-240 V/AC
Length	196 mm	Channels	1, 2, 3
Width	75 mm	Mounting Location	Inside

Article		Output Voltage	Price
843274	■	12 V/DC	€ 139.95
843275	■	24 V/DC	€ 139.95

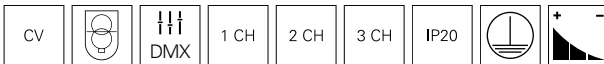

Accessories

930697 Data cable RJ45 for DMX dimmer, Type: Cat5e, 2m



€ 3.95



Technical data sheet

New in the onlineshop: The technical data sheets offer even more information: Light and energy data, light distribution curves, dimensional drawings and more.

electr. data			dimmmable via				usage / design			electrical limit values		power supply	
current strength	power	voltage	leading cut-off	touch dimmer [push]	DALI	KNX	indoor	outdoor	design	capacitive load	max. quantity per automatic circuit breaker	item number	page
350 mA	0,9-3,9W	2,5-11V					x	x	mini		B10A=70, B16A=112, C10A=140, C16A=224	872129	794
350 mA	2,1-4,0W	6-12V	x				x	x	mini	10.00nF	B10A=35, B16A=56, C10A=74, C16A=118	872132	796
350 mA	0,7-6,0W	2-18V					x		flat	40.44nF	B10A=17, B16A=28, C10A=37, C16A=59	872628	794
350 mA	3,2-8,0W	9-23V					x		round	200uF	B10A=17, B16A=28, C10A=37, C16A=59	862212	793
350 mA	3,9-9,0W	11-26V	x				x		basic		B10A=17, B16A=28, C10A=37, C16A=59	862202	797
350 mA	6,0-10,0W	17-29V					x		mini		B10A=57, B16A=92, C10A=57, C16A=92	862239	794
350 mA	6,3-12,0W	18-35V	x				x		basic	20,65pF	B10A=17, B16A=28, C10A=37, C16A=59	862203	797
350 mA	0,7-12,0W	2-35V					x		flat	194,0uF	B10A=11, B16A=18, C10A=24, C16A=39	862223	794
350 mA	6,3-12,0W	18-37V	x				x	x	octo	190uF	B10A=35, B16A=56, C10A=74, C16A=118	862235	796
350 mA	9,1-15,0W	26-43V	x				x		basic		B10A=38, B16A=61, C10A=38, C16A=61	862266	799
350 mA	0,7-18,0W	2-52V					x		basic	147nF	B10A=17, B16A=28, C10A=37, C16A=59	180512	795
350 mA	9,8-20,0W	28-57V	x				x		basic		B10A=11, B16A=18, C10A=24, C16A=39	862204	797
350 mA	0,7-20,0W	2-57V					x		flat	195uF	B10A=11, B16A=18, C10A=24, C16A=39	862224	794
450 mA	9,9-19,0W	22-42V	x				x		quick		B10A=11, B16A=18, C10A=24, C16A=39	862257	798
500 mA	1,0-4,0W	2-8V					x	x	mini	19.8pF	B10A=17, B16A=28, C10A=37, C16A=59	872065	793
500 mA	2,0-4,0W	4-8V	x				x	x	mini	4.75nF	B10A=35, B16A=56, C10A=74, C16A=118	872014	796
500 mA	1,0-6,0W	2-12V					x		flat	38.48nF	B10A=17, B16A=28, C10A=37, C16A=59	862130	794
500 mA	3,0-8,0W	6-16V					x		round	62.96nF	B10A=11, B16A=18, C10A=24, C16A=39	862128	793
500 mA	1,0-12,0W	2-24V					x		flat	298uF	B10A=11, B16A=18, C10A=24, C16A=39	862225	794
500 mA	6,5-10,0W	13-20V					x		mini		B10A=57, B16A=92, C10A=57, C16A=92	862238	794
500 mA	6,0-12,0W	12-24V	x				x	x	octo	186uF	B10A=35, B16A=56, C10A=74, C16A=118	862236	796
500 mA	1,0-18,0W	2-38V					x		basic	147nF	B10A=17, B16A=28, C10A=37, C16A=59	180513	795
500 mA	1,0-20,0W	2-40V					x		flat	292uF	B10A=11, B16A=18, C10A=24, C16A=39	862226	794
500 mA	10,0-20,0W	20-40V	x				x		basic		B10A=11, B16A=18, C10A=24, C16A=39	862205	797
500 mA	15,0-30,0W	30-60V					x		basic	366nF	B10A=11, B16A=18, C10A=24, C16A=39	862196	795
500 mA	20,0-40,0W	40-80V					x		basic	356nF	B10A=8, B16A=14, C10A=18, C16A=29	862197	795

electr. data			dimmable via				usage / design			electrical limit values		power supply	
current strength	power	voltage	leading cut-off	touch dimmer (push)	DALI	KNX	indoor	outdoor	design	capacitive load	max. quantity per automatic circuit breaker	item number	page
500 mA	20,0-40,0 W	40-80V	x				x		basic	29.84nF	B10A=35, B16A=56, C10A=35, C16A=56	862136	797
700 mA	1,7-4,0 W	2-6V					x	x	mini	82pF	B10A=70, B16A=112, C10A=140, C16A=224	872131	793
700 mA	2,0-4,0 W	2,5-6V	x				x	x	mini	10nF	B10A=35, B16A=56, C10A=74, C16A=118	872134	796
700 mA	1,4-6,0 W	2-9V					x		flat	40.44nF	B10A=17, B16A=28, C10A=37, C16A=59	862048	794
700 mA	4,2-8,0 W	6-12V					x		round	46.24nF	B10A=11, B16A=18, C10A=24, C16A=39	862129	793
700 mA	1,4-12,0 W	2-17V					x		flat	427uF	B10A=11, B16A=18, C10A=24, C16A=39	862227	794
700 mA	7,0- 12,0 W	10-17V	x				x	x	octo	188uF	B10A=35, B16A=56, C10A=74, C16A=118	862237	796
700 mA	1,4-18,0 W	2-26V					x		basic	147nF	B10A=17, B16A=28, C10A=37, C16A=59	180514	795
700 mA	1,4-20,0 W	2-29V					x		flat	295uF	B10A=11, B16A=18, C10A=24, C16A=39	862228	794
700 mA	9,8-20,0 W	14-28V	x				x		basic		B10A=11, B16A=18, C10A=24, C16A=39	862207	797
700 mA	9,1-30,0 W	13-43V					x		basic		B10A=11, B16A=18, C10A=24, C16A=39	862198	795
700 mA	20,3-35,0 W	29-57V					x		basic	359,3nF	B10A=8, B16A=14, C10A=18, C16A=29	862199	795
700 mA	19,6-40,0 W	28-56V	x				x		basic		B10A=35, B16A=56, C10A=35, C16A=56	862208	797
900mA	19,8-40,0 W	22-44V					x		basic	13.5pF	B10A=8, B16A=14, C10A=18, C16A=29	862157	795
900mA	19,8-40,0 W	22-44V	x				x		basic	30nF	B10A=35, B16A=56, C10A=35, C16A=56	862264	797
1050 mA	20,0-40,0 W	19-38V					x		basic		B10A=8, B16A=14, C10A=18, C16A=29	862201	795
1050 mA	20,0-40,0 W	19-38V	x				x		basic		B10A=35, B16A=56, C10A=35, C16A=56	862209	797
1050 mA	23,5-45,0 W	22-43V	x				x		basic	33,46nF	B10A=35, B16A=56, C10A=35, C16A=56	862210	797
1050 mA	23,1-45,0 W	22-43V	x				x		quick	33,46nF	B10A=35, B16A=56, C10A=35, C16A=56	862258	798
1300 mA	26,0-50,0 W	20-39V	x				x		basic		B10A=35, B16A=56, C10A=35, C16A=56	862211	797
1500 mA	40,0-60,0 W	27-42V	x				x		quick		B10A=25, B16A=41, C10A=25, C16A=41	862259	798

power supplies design



mini



round / octo



flat



basic



long-flat



IP

* special design

electr. data			dimmable via			usage / design			electrical limit values		power supply	
current strength	power	voltage	leading cut-off	touch dimmer [push]		indoor	outdoor	design	capacitive load	max. quantity per automatic circuit breaker	item number	page
				DALI	KNX							
MULTI*	3,2-20,0 W	9-40V	x			x		basic		B10A=46, B16A=74, C10A=93, C16A=149	862141	799
MULTI*	3,2-12,0 W	15-54V		x	x	x		basic		B10A=23, B16A=37, C10A=46, C16A=74	862190	801
MULTI*	5,0-25,0 W	20-60V		x	x	x		basic		B10A=23, B16A=37, C10A=46, C16A=74	862191	801
MULTI*	8,75-45,0 W	21-70V		x	x	x		basic		B10A=12, B16A=20, C10A=25, C16A=40	862192	801
MULTI*	14,7-45,0 W	14-43V		x	x	x		basic		B10A=12, B16A=20, C10A=25, C16A=40	862193	801
MULTI*	26,3-75,5 W	25-71V		x	x	x		basic		B10A=3, B16A=5, C10A=6, C16A=10	862194	801
MULTI*	2,1-25,2 W	6-54V		x	x	x		*		B10A=16, B16A=26, C10A=27, C16A=44	862246	802
MULTI*	0,70 - 42,00 W	2-100V		x	x	x		*		B10A=16, B16A=26, C10A=27, C16A=44	862247	802
MULTI*	1,0-60,3 W	2-90V		x	x	x		*		B10A=15, B16A=25, C10A=20, C16A=32	862248	802

* Due to the large number of possible settings, please refer to the detailed technical data on the specified product page.

TIPS AND TRICKS FOR CURRENT-STABLE POWER SUPPLIES

In contrast to voltage-stable power supplies [CV], current-stable power supply units, often abbreviated to CC [constant current], the output current is stable. This important factors that must be taken into focus during planning and installation.

- Do not connect LEDs to CC power supply units below voltage, as this can damage them and cause them to fail after a short period of operation.
- if possible: 1 luminaire = 1 power supply
- if necessary: operate max. 2 luminaires in a series connection on one power supply unit. However, the voltage range and the power of the power supply must be checked carefully.

Netzgerätedaten prüfen! Check driver data!

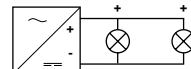
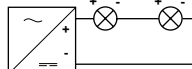
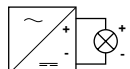

Installationshinweis für Netzgerät stromstabil [CC]: LED nicht unter Spannung anschließen!
installation instruction for power supply constant current [CC]: Don't connect LED under voltage!



DEKO-LIGHT POWER SUPPLY UNITS CC | MINI DESIGN

- Flicker-free
- Secured against short circuits and overloads
- Overheating protection

Housing	Polycarbonate	Height	21 mm
Length	53 mm	Mounting Location	Inside, Outside
Width	27 mm		

Article	Output Current	Power	Output Voltage	Rated Input Voltage	Price
872129 ■	350 mA	0.9-3.9 W	2.5-11 V/DC	220-240 V/AC	€ 12.95
872065 ■	500 mA	1.0-4.0 W	2-8 V/DC	100-240 V/AC	€ 12.95
872131 ■	700 mA	1.7-4.0 W	2.5-6 V/DC	220-240 V/AC	€ 12.95



DEKO-LIGHT POWER SUPPLY UNITS CC | ROUND DESIGN

- Ultra-compact design
- Flicker-free
- Short-circuit-proof, overload protection, overheating protection

Housing	Plastic	Rated Input Voltage	100-240 V/AC
Height	22 mm	Mounting Location	Inside
Ø	53 mm		

Article	Output Current	Power	Output Voltage	Price
862212 ■	350 mA	3.2-8.0 W	9-23 V/DC	€ 20.95
862128 ■	500 mA	3.0-8.0 W	6-54 V/DC	€ 20.95
862129 ■	700 mA	4.2-8.0 W	6-12 V/DC	€ 20.95





HEP POWER SUPPLY UNITS CC | G5S10W

- compact design
- flicker-free
- secured against short circuits and overloads
- Overheating protection

Housing	Plastic	Height	20 mm
Length	58.1 mm	Rated Input Voltage	220-240 V/AC
Width	39.1 mm	Mounting Location	Inside

Article		Output Current	Power	Output Voltage	Price
862239	<input type="checkbox"/>	350 mA	6.0-10.0 W	17-29 V/DC	€ 26.95
862238	<input type="checkbox"/>	500 mA	6.5-10.0 W	13-32 V/DC	€ 26.95



DEKO-LIGHT POWER SUPPLY UNITS CC | FLAT DESIGN

- Flicker-free
- Secured against short circuits and overloads
- Overheating protection

Housing	Plastic	Mounting Location	Inside
Rated Input Voltage	220-240 V/AC		

Article		Output Current	Power	Output Voltage	Length	Width	Height	Price
862224	<input checked="" type="checkbox"/>	350 mA	0.7-20.0 W	2-57 V/DC	154 mm	50 mm	14 mm	€ 28.95
862223	<input checked="" type="checkbox"/>	350 mA	0.7-12.0 W	2-35 V/DC	128 mm	50 mm	13 mm	€ 24.95
872628	<input checked="" type="checkbox"/>	350 mA	0.7-6.0 W	2-18 V/DC	98 mm	46 mm	11 mm	€ 17.95
862226	<input checked="" type="checkbox"/>	500 mA	1.0-20.0 W	2-40 V/DC	154 mm	50 mm	14 mm	€ 28.95
862225	<input checked="" type="checkbox"/>	500 mA	1.0-12.0 W	2-24 V/DC	128 mm	50 mm	13 mm	€ 24.95
862130	<input checked="" type="checkbox"/>	500 mA	1.0-6.0 W	2-12 V/DC	98 mm	46 mm	11 mm	€ 17.95
862228	<input checked="" type="checkbox"/>	700 mA	1.4-20.0 W	2-29 V/DC	128 mm	50 mm	14 mm	€ 28.95
862227	<input checked="" type="checkbox"/>	700 mA	1.4-12.0 W	2-17 V/DC	128 mm	50 mm	14 mm	€ 24.95
862048	<input checked="" type="checkbox"/>	700 mA	1.4-6.0 W	2-9 V/DC	98 mm	46 mm	11 mm	€ 17.95





DEKO-LIGHT POWER SUPPLY UNITS CC | BASIC DESIGN

- Flicker-free
- Secured against short circuits and overloads
- Overheating protection

Housing Plastic Mounting Location Inside
 Rated Input Voltage 220-240 V/AC

Article	Output Current	Power	Output Voltage	Length	Width	Height	Price
180512	350 mA	0.7-18.0 W	2-52 V/DC	115 mm	45 mm	21 mm	€ 23.95
180513	500 mA	1.0-18.0 W	2-38 V/DC	115 mm	45 mm	21 mm	€ 23.95
862196	500 mA	15.0-30.0 W	30-60 V/DC	127 mm	43 mm	28 mm	€ 26.95
862197	500 mA	20.0-40.0 W	40-80 V/DC	127 mm	43 mm	28 mm	€ 29.95
180514	700 mA	1.4-18.0 W	2-26 V/DC	115 mm	45 mm	21 mm	€ 23.95
862198	700 mA	14.0-30.0 W	21-43 V/DC	127 mm	43 mm	28 mm	€ 26.95
862199	700 mA	20.0-40.0 W	29-57 V/DC	127 mm	43 mm	28 mm	€ 29.95
862157	900 mA	19.0-40.0 W	22-24 V/DC	127 mm	43 mm	28 mm	€ 29.95
862201	1050 mA	20.0-40.0 W	19-38 V/DC	127 mm	43 mm	28 mm	€ 29.95





DEKO-LIGHT POWER SUPPLY UNITS CC DIM | MINI DESIGN

- Can be dimmed using leading-edge/trailing-edge phase dimmers
- Secured against short circuits and overloads
- Overheating protection

Housing	Plastic	Mounting Location	Inside, Outside
Rated Input Voltage	220-240 V/AC		

Article	Output Current	Power	Output Voltage	Length	Width	Height	Price
872132 ■	350 mA	2.1-4.0 W	6-12 V/DC	48 mm	30 mm	20 mm	€ 19.95
872014 □	500 mA	2.0-4.0 W	4-8 V/DC	53 mm	27 mm	21 mm	€ 19.95
872134 ■	700 mA	2.0-4.0 W	2.5-6 V/DC	48 mm	30 mm	20 mm	€ 19.95



DEKO-LIGHT POWER SUPPLY UNITS CC DIM | OCTO DESIGN

- Can be dimmed using leading-edge/trailing-edge phase dimmers
- Flicker-free
- Secured against short circuits and overloads
- Overheating protection

Housing	Plastic	Height	24 mm
Length	50 mm	Rated Input Voltage	220-240 V/AC
Width	48 mm	Mounting Location	Inside, Outside

Article	Output Current	Power	Output Voltage	Price
862235 ■	350 mA	6.3-12.0 W	18-37 V/DC	€ 29.95
862236 ■	500 mA	6.0-12.0 W	12-24 V/DC	€ 29.95
862237 ■	700 mA	7.0-12.0 W	10-17 V/DC	€ 29.95





DEKO-LIGHT POWER SUPPLY UNITS CC DIM | BASIC DESIGN

- can be dimmed using trailing-edge phase dimmers
- flicker-free
- short circuit, overload and overheating protection

Housing Plastic Mounting Location Inside
 Rated Input Voltage 220-240 V/AC

Article	Output Current	Power	Output Voltage	Length	Width	Height	Price
862202 ■	350 mA	3.9-9.0 W	11-26 V/DC	115 mm	39 mm	22 mm	€ 28.95
862203 ■	350 mA	6.3-12.0 W	19-38 V/DC	115 mm	39 mm	22 mm	€ 36.95
862204 ■	350 mA	9.8-20.0 W	28-57 V/DC	127 mm	44 mm	28 mm	€ 39.95
862205 ■	500 mA	10.0-20.0 W	20-40 V/DC	127 mm	44 mm	28 mm	€ 39.95
862136 ■	500 mA	20.0-40.0 W	40-80 V/DC	166 mm	52 mm	24 mm	€ 46.95
862207 ■	700 mA	9.8-22.0 W	14-35 V/DC	127 mm	44 mm	28 mm	€ 39.95
862208 ■	700 mA	19.0-40.0 W	28-56 V/DC	166 mm	52 mm	24 mm	€ 46.95
862264 ■	900 mA	19.6-40.0 W	22-44 V/DC	166 mm	52 mm	25 mm	€ 46.95
862209 ■	1050 mA	20.0-40.0 W	19-38 V/DC	166 mm	55 mm	25 mm	€ 46.95
862210 ■	1050 mA	23.0-45.0 W	22-43 V/DC	166 mm	52 mm	25 mm	€ 49.95
862211 □	1300 mA	25.0-50.0 W	20-39 V/DC	166 mm	55 mm	25 mm	€ 51.95



Lighting design

Interested in our lighting design service?

Your contact person will be happy to answer any questions you may have.



DEKO-LIGHT POWER SUPPLY UNITS CC DIM | QUICK DESIGN

- particularly quick and easy to install with integrated three-pin feed-through wiring
- Push terminals for lines from 0.5 to 1.5 mm²
- push terminals also on secondary side
- no additional installation material required
- can be dimmed using compatible (C-compatible) trailing-edge phase dimmers
- flicker-free
- secured against short circuits and overloads
- Overheating protection

Housing	Plastic	Height	32 mm
Length	208 mm	Rated Input Voltage	220-240 V/AC
Width	60 mm	Mounting Location	Inside

Article	Output Current	Power	Output Voltage	Price
862257 ■	450 mA	9.9-19.0 W	22-42 V/DC	€ 36.95
862258 ■	1050 mA	23.1-45.0 W	22-43 V/DC	€ 46.95
862259 ■	1500 mA	40.5-63.0 W	27-42 V/DC	€ 56.95



Technical data sheet

New in the onlineshop: The technical data sheets offer even more information: Light and energy data, light distribution curves, dimensional drawings and more.



HEP POWER SUPPLY UNIT CC DIM | G6LT15W350LR-Z

- Dimmable with trailing edge phase dimmers
- Flicker-free
- Short-circuit and overload-proof
- overheating protection

Housing	Plastic	Width	40.4 mm
Output Current	350 mA	Height	22 mm
Power	9.1-15 W	Rated Input Voltage	220-240 V/AC
Output Voltage	26-43 V/DC	Mounting Location	Inside
Length	85 mm		

Article Price

862266 € 32.95



DEKO-LIGHT POWER SUPPLY UNITS CC DIM | BASIC MULTI-CURRENT

- Can be dimmed using leading-edge/trailing-edge phase dimmers
- Short-circuit-proof, overload protection, overheating protection

Housing	Plastic	Height	28.5 mm
Length	150 mm	Rated Input Voltage	200-240 V/AC
Width	42.5 mm	Mounting Location	Inside

Article Price

Article	Price	Technical Description
862141 <input type="checkbox"/>	€ 41.95	350 mA/3.2-14.0 W/9-40 V 400 mA 3.60-16.00 W/9-40 V 450 mA 4.00-18.00 W/9-40 V 500 mA 4.50-20.00 W/9-40 V 550 mA 5.00-19.80 W/9-36 V 600 mA 5.40-19.80 W/9-33 V 650 mA 5.90-19.50 W/9-30 V 700 mA 6.30-19.60 W/9-28 V



DEKO-LIGHT MULTI-CURRENT DALI 2.0 POWER SUPPLIES DALI 2 IE-12D | IE-25D | IE-45D | IE-45HD | IE-75D

A must for every electrician: the new MULT-CC DALI 2.0 power supplies from DEKO-LIGHT are a real all-purpose weapon for universal use.

They can be controlled via DALI1 or DALI2 [fully upward and downward compatible] or via Intelli-Push. In this case, the multi-current-power supplies do not require any additional control components and are controlled by means of cost-effective 230V standard push-buttons. With the new Intelli-Push function, they also have a pioneering synchronisation option if one of the connected power supplies no longer runs synchronously with the others.

In addition, the MULTI-power supplies can also be operated undimmed without control as a reliable and universal power supplier. With a total of five models, the new DALI series covers a CC current range from 180mA to 1600mA and power ratings from 4 to 75 watts.

- plastic housing
- compact housing design
- suitable for indoor use
- flicker free
- short-circuit proof and overload protection
- overheat control
- current range adjustable via DIP switch
- DALI 2 BUS ready according to IEC 62386
- fully downward compatible with DALI 1
- dimming range: 1-100%
- dimmable via DALI or touch dimmer function [push] new Intelli-Push function [key combination synchronises all connected power supplies]
- can also be operated without control as universal power supply unit universal power supply [no dimming function]
- 3.2-75 watts and 37 CC variants in only 3 different housing sizes



design example 114 x 52 x 24 mm



design example 133 x 71 x 24 mm



design example 159 x 79 x 30 mm

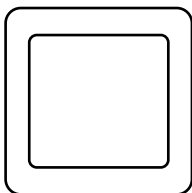

controllable with DALI2, DALI1 or by touch dim using a regular 230V push-button

TOUCH-DIM / INTELLI-PUSH VIA 230V PUSH BUTTON WITHOUT ADDITIONAL CONTROL:

press button short switch lamp on/off

press button long dim lamp bright/dark/bright

press button for 15 seconds All connected power supplies are synchronised to the same brightness.



DEKO-LIGHT POWER SUPPLY UNITS CC DIM | MULTI-CURRENT DALI

- can be dimmed using DALI1/DALI2
- can be dimmed via 230 V push-button (on/off, brightness)
- Intelli-Push function (button combination synchronises all connected power supply units when needed)
- Current range adjustable using DIP switch
- can be operated without actuation/dimming
- Dimming range 1-100 %
- flicker-free
- short circuit and overload protection, Overheating protection

Housing	Plastic	Mounting Location	Inside
Rated Input Voltage	220-240 V/AC		

Article	Technical Description	Length	Width	Height	Price
862190 ■	180 mA / 3.2-9.8 W / 18-54 V 230 mA / 4.0-12.0 W / 18-52 V 260 mA / 4.0-12.0 W / 15-46 V 300 mA / 4.5-12.0 W / 15-42 V 350 mA / 5.2-12.0 W / 15-34 V 400 mA / 6.0-12.0 W / 15-30 V 450 mA / 6.8-12.0 W / 15-27 V 500 mA / 7.5-12.0 W / 15-24 V	119 mm	52 mm	24 mm	€ 59.95
862191 ■	260 mA / 5.0-15.5 W / 20-60 V 350 mA / 7.00-20.00 W / 20-60 V 400 mA / 8.00-24.00 W / 20-60 V 450 mA / 9.00-25.00 W / 20-55 V 500 mA / 10.00-25.00 W / 20-50 V 550 mA / 11.00-25.00 W / 20-45 V 600 mA / 12.00-25.00 W / 20-42 V 700 mA / 14.00-25.00 W / 20-36 V	119 mm	52 mm	24 mm	€ 64.95
862192 ■	350 mA / 8.75-24.50 W / 25-70 V 500 mA / 12.50-35.00 W / 25-70 V 600 mA / 15.00-42.00 W / 25-70 V 700 mA / 17.50-45.00 W / 25-64 V 800 mA / 20.00-45.00 W / 25-56 V 900 mA / 22.50-45.00 W / 25-50 V	133 mm	71 mm	24 mm	€ 69.95
862193 ■	1,050 mA / 25.00-45.00 W / 21-43 V 1,050 mA / 14.70-45.00 W / 14-43 V 1,150 mA / 16.10-45.00 W / 14-39 V 1,200 mA / 16.80-45.00 W / 14-38 V 1,300 mA / 18.20-45.00 W / 14-35 V 1,400 mA / 19.60-45.00 W / 14-32 V 1,500 mA / 21.00-45.00 W / 14-30 V 1,600 mA / 22.40-45.00 W / 14-28 V	135 mm	72 mm	24 mm	€ 69.95
862194 ■	1,050 mA / 26.30-74.50 W / 25-71 V 1,150 mA / 28.80-74.80 W / 25-65 V 1,200 mA / 30.00-74.40 W / 25-62 V 1,300 mA / 32.50-75.50 W / 25-58 V 1,400 mA / 35.00-74.20 W / 25-53 V 1,500 mA / 37.50-75.00 W / 25-50 V 1,600 mA / 40.00-75.20 W / 25-47 V	159 mm	79 mm	30 mm	€ 84.95





MEANWELL POWER SUPPLY UNITS CC DIM | MULTI LCM DALI

- can be dimmed using DALI2, DALI1 or Intelli-Push (Touch-Dim via 230 V button)
- Current range adjustable using DIP switch
- can be operated without actuation/dimming
- flicker-free

Housing Plastic Mounting Location Inside
 Height 23 mm

Article	Technical Description	Length	Width	Rated Input Voltage	Price
862247 <input type="checkbox"/>	350 mA / 0.7-35.0 W / 2-100 V 500 mA / 1.0-40.0 W / 2-80 V 600 mA / 1.2-40.0 W / 2-67 V 700 mA / 1.4-40.0 W / 2-57 V 900 mA / 1.8-40.5 W / 2-45 V 1,050 mA / 2.1-42.0 W / 2-40 V	123.5 mm	81.5 mm	180-295 V/AC	€ 104.95
862246 <input type="checkbox"/>	350 mA / 2.1-18.9 W / 6-54 V 500 mA / 3.0-25.2 W / 6-50 V 600 mA / 3.6-25.2 W / 6-42 V 700 mA / 4.2-25.2 W / 6-36 V 900 mA / 5.4-25.2 W / 6-28 V 1,050 mA / 6.3-25.2 W / 6-24 V	105 mm	68 mm	180-277 V/AC	€ 89.95
862248 <input type="checkbox"/>	500 mA / 1.0-45.0 W / 2-90 V 600 mA / 1.2-54.0 W / 2-90 V 700 mA / 1.4-60.3 W / 2-86 V 900 mA / 1.8-60.3 W / 2-67 V 1,050 mA / 2.1-59.9 W / 2-57 V 1,400 mA / 2.8-59.0 W / 2-42 V	123.5 mm	81.5 mm	180-295 V/AC	€ 109.95





TCI POWER SUPPLY UNIT CC/CV DIM | JOLLY MD PUSH

- Dimmable with leading edge phase control dimmers
- current [CC] or voltage constant [CV] adjustable via dip switch
- Dimmable via leading edge phase control or push [touch dim via 230V push-button]
- Master/slave operation of several power supply units via sync cable [accessories]

Housing	Plastic	Height	35 mm
Length	165 mm	Rated Input Voltage	220-240 V/AC
Width	48 mm	Mounting Location	Inside

Article	Technical Description	Price
561201	<input type="checkbox"/> courant constant 350 mA / 0,7 - 16,5 W / 2 - 47 V 500 mA / 1,0 - 23,5 W / 2 - 47 V 550 mA / 1,1 - 25,9 W / 2 - 47 V 700 mA / 1,4 - 32,0 W / 2 - 46 V 750 mA / 1,5 - 32,0 W / 2 - 43 V voltage constant 12 V / 10,0 W 24 V / 20,0 W 28 V / 22,0 W	€ 94.95



Accessories

561202 Sync cable



€ 10.95

electr. data		dimmable via			usage / design			electrical limit values		power supply		
current strength	power	electronic power supply	conventional transformer	leading edge	leading cut-off	indoor	outdoor design	capacitive load	max. quantity per automatic circuit breaker	item number	page	
electronic power supply units:												
12V	0,0-70,0 W	x			x	x		basic	97.79nF	B10A=8, B16A=14, C10A=18, C16A=29	180515	805
12V	0,0-105,0 W	x			x	x		basic	139.58nF	B10A=5, B16A=9, C10A=12, C16A=19	180529	805
wound transformers:												
12V	11,5-20,0 W		x	x		x		*			000097	806
12V	34,5-60,0 W		x	x		x		*			000099	806
12V	43,5-75,0 W		x	x		x	x	*			000140	807
12V	60,5-105,0 W		x	x		x		*			000107	806
12V	86,5-150,0 W		x	x		x		*			000103	806
12V	86,5-150,0 W		x	x		x	x	*			000141	807
12V	115,0-200,0 W		x	x		x		*			000104	806
12V	172,5-300,0 W		x	x		x		*			000106	806
12V	172,5-300,0 W		x	x		x	x	*			000142	807
12V	287,5-500,0 W		x	x		x		*			000109	804



DEKO-LIGHT TRANSFORMER CV DIM | ULTRA HALOGEN 12 VOLT/AC

- Dimmable with trailing edge phase dimmers
- 11.5V lamp extra-low voltage
- flicker-free
- Short-circuit and overload-proof
- overheating protection
- 180515: 0-70W halogen or 0-50W LED / max. 6x LED
- 180529: 0-105W halogen or 0-50W LED / max. 6x LED

Housing	Plastic	Height	28 mm
Output Voltage	11.5 V/AC	Rated Input Voltage	220-240 V/AC
Length	115 mm	Mounting Location	Inside
Width	45 mm		

Article		Power	Price
180529	■	0.0-105.0 W	€ 22.95
180515	■	0.0-70.0 W	€ 17.95



Onlineshop

You can find more information about the products in the onlineshop:
Detailed images, videos, project reports, LDT files, EPREL data sheets and more.



ABN TRANSFORMERS CV DIM | 12 VOLT/AC

- Conventional wound transformer (L load)
- 11.5 V lamp-friendly voltage
- Can be dimmed using leading-edge dimmers

Housing	Plastic	Rated Input Voltage	220-240 V/AC
Output Voltage	11.5 V/AC	Mounting Location	Inside

Article	Power	Apparent power	Length	Width	Height	Price
000097 <input type="checkbox"/>	11.5-20.0 W	20 VA	82 mm	56 mm	50 mm	€ 79.95
000099 <input type="checkbox"/>	34.5-60.0 W	60 VA	100 mm	70 mm	61 mm	€ 109.95
000107 <input type="checkbox"/>	60.0-105.0 W	105 VA	107 mm	78 mm	66 mm	€ 139.95
000103 <input type="checkbox"/>	86.5-150.0 W	150 VA	130 mm	88 mm	78 mm	€ 159.95
000104 <input type="checkbox"/>	115.0-200.0 W	200 VA	130 mm	88 mm	88 mm	€ 189.95
000106 <input type="checkbox"/>	172.0-300.0 W	300 VA	130 mm	88 mm	103 mm	€ 209.95
000109 <input type="checkbox"/>	287.5-500.0 W	500 VA	177 mm	107 mm	130 mm	€ 369.95



Accessories for **000103**, **000104**, **000106**

000111 Housing Pyra 120-300VA



€ 19.95

Accessories for **000107**

000110 Housing Pyra 105VA



€ 19.95



ABN TRANSFORMERS CV DIM IP | 12 VOLT/AC

- Housing made of UV-resistant plastic
- Conventional, wound transformer [L-load]
- 11.5V lamp extra-low voltage
- Primary connection cable 1.9 m [H05RR-F 2x0.75 mm²]
- Secondary connection cable 0.5 m [H05RR-F 2x2.5 mm²]
- Dimmable via leading edge phase control

Housing	Plastic	Rated Input Voltage	220-240 V/AC
Output Voltage	11.5 V/AC	Mounting Location	Inside, Outside

Article		Power	Apparent power	Length	Width	Height	Price
000140	■	43.0-75.0 W	75 VA	108 mm	81 mm	66 mm	€ 149.95
000141	■	86.0-150.0 W	150 VA	130 mm	93 mm	78 mm	€ 189.95
000142	■	172.0-300.0 W	300 VA	130 mm	93 mm	102 mm	€ 249.95

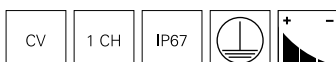



CONTROLLER

- 810 controller | overview
- 812 RF-smart
- 834 RF control
- 840 Casambi Bluetooth
- 844 DMX wall controller
- 850 DMX controller
- 852 DMX dimmer
- 858 DALI PWM dimmer



■ page 833



■ page 832



■ page 856



■ □ page 815



■ page 818



■ page 820



■ page 821



□ ■ page 822



■ page 824



□ page 825



□ page 828



□ page 829

controller



page 836



page 841



page 842



page 842



page 843



page 844



page 845



page 846



page 847



page 848



page 850



page 851



page 852



page 853



page 854



page 857



page 858



page 860



page 860



page 861



page 861

RF-SMART: COMPONENTS

We hereby present the multifunctional RF-smart control system from DEKO-LIGHT. It enables the switching and dimming of devices with 230V mains voltage and offers LED dimmers for LED strips with 1-5 channels from 12V to 48V voltage. Dimmers in IP67 design are available for outdoor use. The system is complemented by luminaires with an integrated RF module, such as outdoor spotlights and LED retrofit luminaires. RF-smart components can be controlled with RF radio remote controls and Zigbee 3.0 compatible radio modules. This enables control via smartphone, tablet or voice and offers comprehensive smart home functions. Installation is quick and easy.

remote controls

The remote controls can be used to control the components on different channels in one or more zones. The remote controls are available as mobile versions or for wall mounting.

- 1 zone [1-2 oder 3-5 channels]
- 4 zones [1-5 channels]
- 8 zones [1-5 channels]
- power supply via 2x AAA batteries [3V]



repeater

With the repeater, the wireless range of the remote controls can be extended by up to 30 metres.

- 230V AC



simple control via RF remote controls



smart control via ZigBee 3.0



control via push-button

illuminants

The LED retrofit illuminants are equipped with an RF-smart radio module and fit into standard GU10 and E27 sockets.

- GU10 RGB+CCT
- E27 A60/MAX RGB+CCT
- 230V AC
- controllable via remote control

**luminaires**

The RF-smart lights are equipped with a ZigBee-compatible wireless module and can therefore also be controlled via the market-leading smart home systems from Amazon, Google & Co.

- FLOOD RGB+CCT
- SPOT RGB+CCT
- 230V AC
- IP67 / IP44
- controllable via remote control and ZigBee 3.0

**Triac dimmer**

The triac dimmers work with phase cut-off dimming and enable the switching and/or dimming of devices with 230V mains voltage.

- 230V AC
- IP20 / IP67
- on/off, Dimmen
- controllable via remote control, push-button and ZigBee 3.0

**LED dimmer**

The LED dimmers can be used to control LED stripes with 1-5 channels and 12V to 48V voltage.

- 12-48V DC
- IP20 / IP67
- on/off, dimming, automatic programmes, RGB/CCT colour settings
- controllable via remote control, push-button and ZigBee 3.0





LIVING SPACE

The choice is yours: equip existing luminaires and LED stripes with a remote-controllable dimmer, replace the illuminants with an LED retrofit version or benefit from ZigBee compatibility to control the lighting via Amazon Alexa and other smart home assistants.

- living spaces
- garden
- path lighting



TRADE

Whether in shops, a bar or on exhibition stands - with RF-smart you can set up and programme different lighting zones and control them via mobile and permanently installed remote controls.

- shop fitting
- Bar/Restaurant
- Hotel
- trade fair



COMPANY

Modern company buildings are becoming ever smarter and, thanks to the progressive networking of all components – including lighting – are making their contribution to energy efficiency and therefore also to positive sales development.

- offices
- meeting rooms
- foyers



DEKO-LIGHT RF-SMART STARTER-SET 1 230V TRIAC DIMMER + RF-REMOTE CONTROL

- Dimmable brightness
- Intelli-Push dim function (on/off, brightness) via potential-free push-button
- can be controlled with all RF smart wireless remote controls (2.4 GHz, range approx. 30 m)
- can be controlled with all Zigbee 3.0 compatible controls/apps such as Amazon Echo (Alexa), Google Assistant, Tuya (relevant gateway required, outdoor range up to 100 m)
- Program and remote control synchronisation when operating multiple RF smart components (repeater function)
- Control of 230 V (R/C) components
- Minimum brightness adjustable in ten steps
- Switch mode adjustable (dimming disabled)
- up to 10x LED-LM/7x LED ballast units can be connected (max. 300 W for R/C loads)
- One control zone
- Remote control operated with 2x AAA batteries (not included in the scope of delivery)
- Set comprises: 1x 843503 + 1x 843508

Housing	Plastic	Rated Input Voltage	100-240 V/AC
Length	25 mm	Control	RF-Smart, Trailing-edge dimmer, ZigBee 3.0, Intelli Push-Dim
Width	70 mm		
Height	70 mm		
Power	1.0-300 W	Channels	1
Output Current	1.36 A		

Article Price

843500 **€ 99.95**





DEKO-LIGHT RF-SMART STARTER-SET 2 LED-DIMMER + RF-REMOTE CONTROL SINGLE/CCT

- Dimmable brightness and colour saturation
- Intelli-Push dim function (on/off, brightness) via potential-free push-button
- can be controlled with all RF smart wireless remote controls (2.4 GHz, range approx. 30 m)
- can be controlled with all Zigbee 3.0 compatible controls/apps such as Amazon Echo (Alexa), Google Assistant, Tuya (relevant gateway required, outdoor range up to 100 m)
- Program and remote control synchronisation when operating multiple RF smart components (repeater function)
- Control of single/CCT
- flicker-free (image/video recordings)
- Power: Max. 20 A/controller, max. 10 A/channel
- 12 V = 240 W, 24 V = 480 W, 48 V = 960 W
- One control zone
- Remote control operated with 2x AAA batteries (not included in the scope of delivery)
- Set comprises: 1x 843505 + 1x 843508

Housing	Plastic	Rated Input Voltage	12-48 V/DC
Length	24 mm	Control	RF-Smart, ZigBee 3.0, Intelli Push-Dim
Width	70 mm		
Height	70 mm		
Output Current	20 A	Channels	1, 2

Article Price

843501  **€ 99.95**

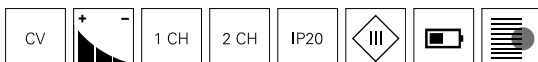



DEKO-LIGHT RF-SMART STARTER-SET 3 LED-DIMMER + RF-REMOTE CONTROL RGB/RGBW/RGB+CCT

- Dimmable brightness and colour saturation
- 16 million colours or adjustable colour temperature
- 18 pre-installed automatic programs
- Intelli-Push dim function (on/off, brightness) via potential-free push-button
- can be controlled with RF smart wireless remote controls (2.4 Ghz, range approx. 30 m)
- can be controlled with all Zigbee 3.0 compatible controls/apps such as Amazon Echo (Alexa), Google Assistant, Tuya (relevant gateway required, outdoor range up to 100 m)
- Program and remote control synchronisation when operating multiple RF smart components (repeater function)
- Control of RGB/RGBW/RGB+CCT
- flicker-free (image/video recordings)
- Power: Max. 20 A/controller, max. 10 A/channel
- 12 V = 240 W, 24 V = 480 W, 48 V = 960 W
- One control zone
- Remote control operated with 2x AAA batteries (not included in the scope of delivery)
- Set comprises: 1x 843505 + 1x 843510

Housing	Plastic	Rated Input Voltage	12-48 V/DC
Length	23 mm	Control	RF-Smart, ZigBee
Width	47 mm		3.0, Intelli Push-Dim
Height	120 mm	Channels	3, 4, 5
Output Current	20 A		

Article Price

843502 **€ 99.95**

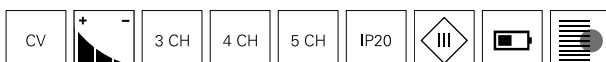



DEKO-LIGHT RF-SMART TRIAC DIMMER 230 V

- Dimmable brightness
- Programme and remote control synchronisation when operating multiple RF-smart components (repeater function)
- Intelli-Push dimming function via potential-free push-button
- Can be controlled with RF-smart wireless remote controls (2.4 GHz, range approx. 30 m, not included in the scope of delivery)
- Can be controlled with all Zigbee 3.0 compatible controllers/apps such as Amazon Echo (Alexa), Google Assistant, Tuya (relevant gateway required, outdoor range up to 100 m)
- For controlling 230 V components
- Minimum brightness adjustable in ten stages
- Up to 10x LED lamps/7x ballasts can be connected (max. 300 W for R/C loads)
- Adjustable switch mode (dimming disabled)

Output Current	1.36 A	Rated Input Voltage	100-240 V/AC
Housing	Plastic	Control	RF-Smart, Trailing-edge dimmer, ZigBee 3.0, Intelli Push-Dim
Length	25 mm		
Width	49 mm		
Height	49 mm	Channels	1
Power	1.0-300 W		

Article Price

843503 ■ € 69.95

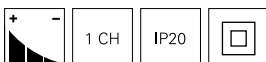



DEKO-LIGHT RF-SMART OUTDOOR TRIAC-DIMMER 230V

- Dimmable brightness
- Intelli-Push dim function (on/off, brightness) via potential-free push-button
- can be controlled with RF smart wireless remote controls (2.4 Ghz, range approx. 30 m, not included in the scope of delivery)
- can be controlled with all Zigbee 3.0 compatible controls/apps such as Amazon Echo (Alexa), Google Assistant, Tuya (relevant gateway required, outdoor range up to 100 m)
- Program and remote control synchronisation when operating multiple RF smart components (repeater function)
- Control of 230 V components
- Minimum brightness adjustable in ten steps
- Switch mode adjustable (dimming disabled, additional load relays can be connected)
- up to 10x LED-LM/7x LED ballast units can be connected (max. 300 W for R/C loads)
- Outdoor distribution board IP67 with up to four cable entry points from 4-14 mm as well as two blanking plugs

Output Current	1.36 A	Rated Input Voltage	100-240 V/AC
Housing	Plastic	Control	RF-Smart, Trail- ing-edge dimmer, ZigBee 3.0, Intelli Push-Dim
Length	170 mm		
Width	155 mm		
Height	65 mm	Channels	1
Power	1.0-300 W		

Article Price

843504 ■ € 89.95





DEKO-LIGHT RF-SMART LED-DIMMER 5-IN-1, 5 CHANNEL SINGLE/CCT/RGB/RGBW/RGB+CCT

- Dimmable brightness and colour saturation
- 16 million colours or adjustable colour temperature
- 18 pre-installed automatic programs
- Intelli-Push dim function (on/off, brightness) via potential-free push-button
- can be controlled with RF smart wireless remote controls (2.4 Ghz, range approx. 30 m, not included in the scope of delivery)
- can be controlled with all Zigbee 3.0 compatible controls/apps such as Amazon Echo (Alexa), Google Assistant, Tuya (relevant gateway required, outdoor range up to 100 m)
- Program and remote control synchronisation when operating multiple RF smart components (repeater function)
- Control of single/CCT/RGB/RGBW/RGB+CCT
- flicker-free (image/video recordings)
- Power: Max. 20 A/controller, max. 10 A/channel
- 12 V = 240 W, 24 V = 480 W, 48 V = 960 W

Housing	Plastic	Rated Input Voltage	12-48 V/DC
Length	23 mm	Control	RF-Smart, ZigBee 3.0, Intelli Push-Dim
Width	47 mm		
Height	120 mm		
Output Current	20 A	Channels	1, 2, 3, 4, 5

Article Price

843505  **€ 69.95**

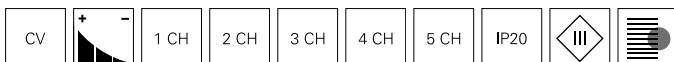



DEKO-LIGHT RF-SMART OUTDOOR LED-DIMMER 5-IN-1, 5 CHANNEL SINGLE/CCT/RGB/RGBW/RGB+CCT

- Dimmable brightness and colour saturation
- 16 million colours or adjustable colour temperature
- 18 pre-installed automatic programs
- can be controlled with RF smart wireless remote controls (2.4 Ghz, range approx. 30 m, not included in the scope of delivery)
- can be controlled with all Zigbee 3.0 compatible controls/apps such as Amazon Echo (Alexa), Google Assistant, Tuya (relevant gateway required, outdoor range up to 100 m)
- Program and remote control synchronisation when operating multiple RF smart components (repeater function)
- Control of single/CCT/RGB/RGBW/RGB+CCT
- flicker-free (image/video recordings)
- Power: Max. 20 A/controller, max. 10 A/channel
- 12 V = 240 W, 24 V = 480 W, 48 V = 960 W
- 20 cm pre-assembled connecting cable

Housing	Plastic	Rated Input Voltage	12-48 V/DC
Length	31 mm	Control	RF-Smart, ZigBee
Width	185 mm		3.0
Height	87 mm	Channels	1, 2, 3, 4, 5
Output Current	20 A		

Article Price

843506 ■ € 109.95

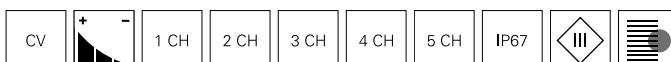



DEKO-LIGHT RF-SMART RF-REMOTE CONTROL SINGLE/CCT

- Dimmable brightness
- colour temperature can be adjusted as required
- One control zone
- Range approx. 30 m
- Can be used as a wall and hand remote control (magnetic holder included in the scope of delivery)
- Simple installation and commissioning
- Battery-operated with 2x AAA (not included in the scope of delivery)
- low power consumption
- Control of single/CCT components

Housing	Plastic	Rated Input Voltage	3 V/DC
Length	24 mm	Control	RF-Smart
Ø	70 mm	Channels	1, 2

Article Price

843508 € 38.95

843509 € 38.95

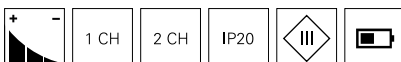



DEKO-LIGHT RF-SMART RF-REMOTE CONTROL RGB/RGBW/RGB+CCT

- Dimmable brightness
- colour saturation and colour temperature can be adjusted as required
- 16 million adjustable colours
- Automatic programs can be controlled
- One control zone
- Range approx. 30 m
- Can be used as a wall and hand remote control (magnetic holder included in the scope of delivery)
- Simple installation and commissioning
- Battery-operated with 2x AAA (not included in the scope of delivery)
- low power consumption
- Control of RGB/RGBW/RGB+CCT

Housing	Plastic	Rated Input Voltage	3 V/DC
Length	24 mm	Control	RF-Smart
Ø	70 mm	Channels	3, 4, 5

Article	Price
843510 <input type="checkbox"/>	€ 38.95
843511 <input checked="" type="checkbox"/>	€ 38.95

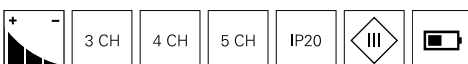

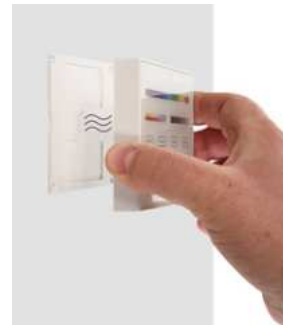

DEKO-LIGHT RF-SMART RF-WALL REMOTE CONTROL 4 ZONES, 3V, SINGLE/CCT/RGB/RGBW/RGB+CCT

- Dimmable brightness
- colour saturation and colour temperature can be adjusted as required
- can be adjusted to 16 million colours as required
- Automatic programs and program speed can be controlled
- Separate white light button
- up to four different control zones
- Range approx. 30 m
- magnetic wall bracket included in scope of delivery
- Simple installation and commissioning
- Battery-operated with 2x AAA (not included in the scope of delivery)
- low power consumption
- Control of single/CCT/RGB/RGBW/RGB+CCT

Housing	Plastic	Rated Input Voltage	3 V/DC
Length	86 mm	Control	RF-Smart
Width	86 mm	Channels	1, 2, 3, 4, 5
Height	16 mm		

Article 843513 Price **€ 69.95**

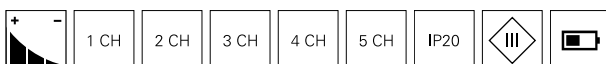



DEKO-LIGHT RF-SMART RF WALL-MOUNTED REMOTE CONTROL, 4 ZONES, 230 V, SINGLE/CCT/RGB/RGBW/RGB+CCT

- Wall remote control for fixed installation
- Brightness dimmable
- Colour saturation and colour temperature adjustable if required
- 16 million colours can be set if required
- Automatic programmes and programme speed controllable
- Separate white light button
- Up to four different control zones
- Range approx. 30 m
- Extremely simple operation
- Installation on 68 mm single switch box
- 230 V / AC mains operation
- Low power consumption
- Control of Single/CCT/RGB/RGBW/RGB+CCT components

Housing	Plastic	Rated Input Voltage	100-240 V/AC
Length	86 mm	Control	RF-Smart
Width	86 mm	Channels	1, 2, 3, 4, 5
Height	9 mm		

Article Price

843522 **€ 74.95**

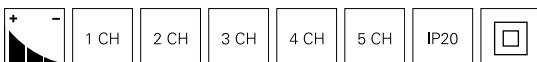



DEKO-LIGHT RF-SMART RF WALL-MOUNTED REMOTE CONTROL, EIGHT ZONES, SINGLE/CCT/RGB/RGBW/RGB+CCT

- Brightness dimmable
- Adjustable colour saturation and colour temperature if required
- 16 million colours can be set if required
- Automatic programmes and programme speed controllable
- Separate white light button
- Up to eight different control zones
- Range approx. 30 m
- Delayed switch-off function [60s]
- Simple commissioning
- Battery operation with 2x AAA [not included]
- versatile mounting options [68 mm switch box for operation with optional 230V power supply unit]
- Low power consumption
- Control of Single/CCT/RGB/RGBW/RGB+CCT components

Housing	Plastic	Rated Input Voltage	3 V/DC
Length	20 mm	Control	RF-Smart
Width	106 mm	Channels	1, 2, 3, 4, 5
Height	146 mm		

Article Price

843514 **€ 109.95**

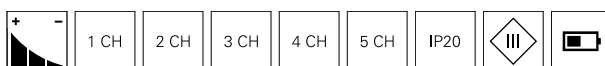

Accessories

872144 RF-smart, 230 V power supply unit for 8-zone wall-mounted remote control (3.3 V DC)



€ 16.95



DEKO-LIGHT RF-SMART RF-REPEATER

- extends the range of an RF remote control by up to 30 m
- supports up to 12 remote controls and/or 12 zones simultaneously
- suitable for outdoor and indoor use
- incl. 1 m connecting cable with IP44 mains plug
- compatible with all RF smart remote controls

Housing	Plastic	Height	34 mm
Length	103 mm	Rated Input Voltage	100-240 V/AC
Width	34 mm	Control	RF-Smart

Article		Price
843507	<input type="checkbox"/>	€ 34.95



Lighting design

Interested in our lighting design service?

Your contact person will be happy to answer any questions you may have.



DEKO-LIGHT RF-SMART LAMP GU10 RGB+CCT WITH RF-CONTROL

- Brightness and colour saturation can be adjusted
- 16 million available colours and adjustable colour temperature
- 18 automatic programmes pre-installed
- Programme and remote control synchronisation when operating multiple RF-smart components (repeater function)
- Can be controlled with RF-smart wireless remote controls (2.4 GHz, range approx. 30 m, not included in the scope of delivery)
- Can only be controlled with RF remote controls [no Zigbee functionality]

Housing	Plastic	Length	57 mm
Colour Temperature	2700-6500 K	Ø	50 mm
Luminous Flux	300 lm	Rated Input Voltage	100-240 V/AC
Power	4 W	Colour Rendering Index (Ra)	80
Light Beam Angle	25 Degree	Control	RF-Smart
Power Consumption	4 kWh/1000h	Channels	5
Life Time L70 / B50	50000 h		

Article	Housing Color	Colour Temperature	Price
843515	<input type="checkbox"/> White	2700-6500 K	€ 34.95



Accessories

843510	RF-smart, remote control, white, 1 zone, RGB/RGBW/RGB+CCT, IP20		€ 38.95
843511	RF-smart, remote control, black, 1 zone, RGB/RGBW/RGB+CCT, IP20		€ 38.95
843512	RF-smart, remote control, black, 8 zones, Single/CCT/RGB/RGBW/RGB+CCT		€ 49.95
843513	RF-smart, wall remote control, white, 3V, 4 zones, Single/CCT/RGB/W/+CCT		€ 69.95
843522	RF-smart, wall remote control, white, 230V, 4 zones, Single/CCT/RGB/W/+CCT		€ 74.95
843514	RF-smart, wall remote control, white, 8 zones, Single/CCT/RGB/RGBW/RGB+CCT		€ 109.95



DEKO-LIGHT RF SMART LAMP E27 A60 RGB+CCT RF-CONTROLLABLE

- Dimmable brightness and colour saturation
- 16 million colours and adjustable colour temperature
- 18 pre-installed automatic programs
- Program and remote control synchronisation when operating multiple RF smart lamps (repeater function)
- can be controlled with RF-SMART wireless remote controls (2.4 GHz, range approx. 30 m, not included in the scope of delivery)
- can only be controlled with RF remote controls (no Zigbee functionality)

Housing	Plastic	Ø	57 mm
Luminous Flux	550 lm	Rated Input Voltage	100-240 V/AC
Power	6 W	Colour Rendering Index (Ra)	80
Light Beam Angle	220 Degree	Control	RF-Smart
Power Consumption	6 kWh/1000h	Channels	5
Life Time L70 / B50	50000 h		
Length	100 mm		

Article	Housing Color	Colour Temperature	Price
843516	<input type="checkbox"/> White	2700-6500 K	€ 34.95



Accessories

843510	RF-smart, remote control, white, 1 zone, RGB/RGBW/RGB+CCT, IP20		€ 38.95
843511	RF-smart, remote control, black, 1 zone, RGB/RGBW/RGB+CCT, IP20		€ 38.95
843512	RF-smart, remote control, black, 8 zones, Single/CCT/RGB/RGBW/RGB+CCT		€ 49.95
843513	RF-smart, wall remote control, white, 3V, 4 zones, Single/CCT/RGB/W/+CCT		€ 69.95
843522	RF-smart, wall remote control, white, 230V, 4 zones, Single/CCT/RGB/W/+CCT		€ 74.95
843514	RF-smart, wall remote control, white, 8 zones, Single/CCT/RGB/RGBW/RGB+CCT		€ 109.95



DEKO-LIGHT RF-SMART LAMP E27 MAX RGB+CCT WITH RF-CONTROL

- Brightness and colour saturation can be adjusted
- 16 million available colours and adjustable colour temperature
- 18 automatic programmes pre-installed
- Programme and remote control synchronisation when operating multiple RF-smart components (repeater function)
- Can be controlled with RF-smart wireless remote controls (2.4 GHz, range approx. 30 m, not included in the scope of delivery)
- Can only be controlled with RF remote controls [no Zigbee functionality]

Housing	Plastic	Ø	74 mm
Luminous Flux	1100 lm	Rated Input Voltage	100-240 V/AC
Power	12 W	Colour Rendering Index (Ra)	80
Light Beam Angle	220 Degree	Control	RF-Smart
Power Consumption	12 kWh/1000h	Channels	5
Life Time L70 / B50	50000 h		
Length	140 mm		

Article Housing Color Colour Temperature Price

843517 White 2700-6500 K **€ 64.95**



Accessories

843510	RF-smart, remote control, white, 1 zone, RGB/RGBW/RGB+CCT, IP20		€ 38.95
843511	RF-smart, remote control, black, 1 zone, RGB/RGBW/RGB+CCT, IP20		€ 38.95
843512	RF-smart, remote control, black, 8 zones, Single/CCT/RGB/RGBW/RGB+CCT		€ 49.95
843513	RF-smart, wall remote control, white, 3V, 4 zones, Single/CCT/RGB/W/+CCT		€ 69.95
843522	RF-smart, wall remote control, white, 230V, 4 zones, Single/CCT/RGB/W/+CCT		€ 74.95
843514	RF-smart, wall remote control, white, 8 zones, Single/CCT/RGB/RGBW/RGB+CCT		€ 109.95



DEKO-LIGHT RF-SMART FLOODLIGHT RGB+CCT RF + ZIGBEE

- Brightness and colour saturation can be adjusted
- 16 million available colours and adjustable colour temperature
- 18 automatic programmes pre-installed
- Programme and remote control synchronisation when operating multiple RF-smart components (repeater function)
- Can be controlled with RF-smart wireless remote controls (2.4 GHz, range approx. 30 m, not included in the scope of delivery)
- Can be controlled with all Zigbee 3.0 compatible controllers/apps such as Amazon Echo (Alexa), Google Assistant, Tuya (relevant gateway required, outdoor range up to 100 m)

Housing	Aluminium, Plastic	Control	RF-Smart, ZigBee
Colour Temperature	2700-6500 K		3.0
Rated Input Voltage	100-240 V/AC	Primary Cable Length	1.5 m
Power Supply Unit incl.	Yes	Colour Rendering Index (Ra)	80
Light Beam Angle	160 Degree	Light Direction	Front
Swivelling Angle	345 Degree	IP Protection Type Plug	IP 44

Article	Housing Color		Luminous Flux	Length	Width	Height	Power	Price
843518	Anthracite	RGB WW CW	3300 lm	167 mm	40 mm	227 mm	30.0 W	€ 249.95
843519	Anthracite	RGB WW CW	4800 lm	220 mm	48 mm	311 mm	50.0 W	€ 349.95
843520	Anthracite	RGB WW CW	10000 lm	295 mm	60 mm	403 mm	100.0 W	€ 549.95



Accessories

843510	RF-smart, remote control, white, 1 zone, RGB/RGBW/RGB+CCT, IP20		€ 38.95
843511	RF-smart, remote control, black, 1 zone, RGB/RGBW/RGB+CCT, IP20		€ 38.95
843512	RF-smart, remote control, black, 8 zones, Single/CCT/RGB/RGBW/RGB+CCT		€ 49.95
843513	RF-smart, wall remote control, white, 3V, 4 zones, Single/CCT/RGB/W/+CCT		€ 69.95
843522	RF-smart, wall remote control, white, 230V, 4 zones, Single/CCT/RGB/W/+CCT		€ 74.95
843514	RF-smart, wall remote control, white, 8 zones, Single/CCT/RGB/RGBW/RGB+CCT		€ 109.95
930659	Wall bracket/display arm, metal, black, 800 mm		€ 59.95



DEKO-LIGHT RF-SMART SPOTLIGHT RGB+CCT RF + ZIGBEE

- Brightness and colour saturation can be adjusted
- 16 million available colours and adjustable colour temperature
- 18 automatic programmes pre-installed
- Programme and remote control synchronisation when operating multiple RF-smart components (repeater function)
- Can be controlled with RF-smart wireless remote controls (2.4 GHz, range approx. 30 m, not included in the scope of delivery)
- Can be controlled with all Zigbee 3.0 compatible controllers/apps such as Amazon Echo (Alexa), Google Assistant, Tuya (relevant gateway required, outdoor range up to 100 m)
- Very narrow light emission angle, optimal for column lighting or similar

Housing	Aluminium, Plastic	Light Beam Angle	15 Degree
Colour Temperature	2700-6500 K	Swivelling Angle	355 Degree
Luminous Flux	1700 lm	Control	RF-Smart, ZigBee
Length	170 mm		3.0
Width	65 mm	Primary Cable Length	1.5 m
Height	180 mm	Colour Rendering Index (Ra)	80
Power	25 W	Light Direction	Front
Rated Input Voltage	100-240 V/AC	IP Protection Type Plug	IP 44
Power Supply Unit incl.	Yes		

Article Housing Color Colour Temperature Price

843521 ■ Anthracite 2700-6500 K € 239.95



Accessories

843510	RF-smart, remote control, white, 1 zone, RGB/RGBW/RGB+CCT, IP20		€ 38.95
843511	RF-smart, remote control, black, 1 zone, RGB/RGBW/RGB+CCT, IP20		€ 38.95
843512	RF-smart, remote control, black, 8 zones, Single/CCT/RGB/RGBW/RGB+CCT		€ 49.95
843513	RF-smart, wall remote control, white, 3V, 4 zones, Single/CCT/RGB/W/+CCT		€ 69.95
843522	RF-smart, wall remote control, white, 230V, 4 zones, Single/CCT/RGB/W/+CCT		€ 74.95
843514	RF-smart, wall remote control, white, 8 zones, Single/CCT/RGB/RGBW/RGB+CCT		€ 109.95
930659	Wall bracket/display arm, metal, black, 800 mm		€ 59.95

DEKO-LIGHT RF

With the DEKO-LIGHT RF system, which has been proven for many years and is easy to install, the radio remote controls can be used to control corresponding receiver systems within a radius of approx. 20 metres. The possibility of connecting only one radio remote control to several controllers also extends the system in a simple way.

Attention: A 100% synchronous control [programme sequence, colour change] of several controller boxes with only one radio remote control can only be realised by a connection via network cable [master-slave function]. The memory function saves the last setting after a power failure. Please note that the components of the RF system are not compatible with the new RF-smart system.

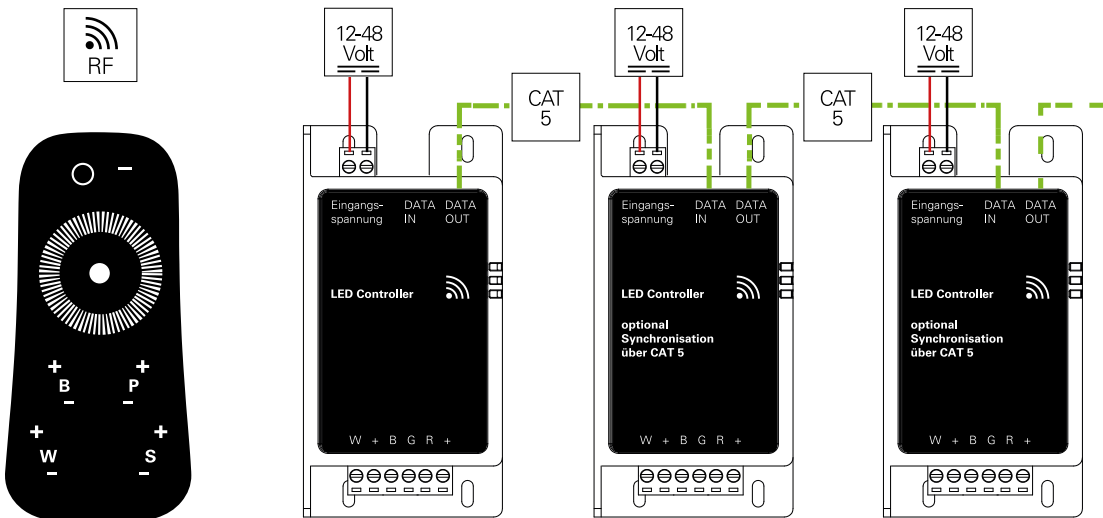

outputs for LED stripes/luminaires



Daniel Vieser . Architekturfotografie, Karlsruhe



DEKO-LIGHT RF CONTROLLER SET RF SINGLE



- for controlling single-channel LED strips
- Set consisting of controller, remote control, wall bracket
- dimmable
- Four effect programs
- adjustable program speed
- max. eight remote controls/two touch panels for each system range
- Memory function
- Master/slave function
- not compatible with RF smart system
- Dimensions of controller L x W x H: 115 x 57 x 25 mm
- max. 7.5 A per channel
- Output:
 - 2 x 90 W (180 W) at 12 V DC
 - 2 x 180 W (360 W) at 24 V DC
 - 2 x 360 W (720 W) at 48 V DC

Housing	Plastic	Output Current	15 A
Length	115 mm	Rated Input Voltage	12-48 V/DC
Width	57 mm	Control	RF 2,4 GHz
Height	25 mm	Channels	1

Article	Price
843056 ■	€ 104.95



Accessories

843064	RF Single		€ 89.95
843014	Touch remote control RF Single		€ 32.95
843013	Wall bracket remote control RF		€ 10.95



DEKO-LIGHT RF CONTROLLER SET RF WHITE



- for controlling WW/CW LED strips
- Set consisting of controller, remote control, wall bracket
- WW or CW dimmable as individual colour
- Nine effect programs
- adjustable program speed
- max. eight remote controls/two touch panels for each system range
- Memory function
- Master/slave function
- not compatible with RF smart system
- Dimensions of controller L x W x H: 115 x 57 x 25 mm
- max. 7.5 A per channel
- Output:
 - 2 x 90 W (180 W) at 12 V DC
 - 2 x 180 W (360 W) at 24 V DC
 - 2 x 360 W (720 W) at 48 V DC

Housing	Plastic	Output Current	15 A
Length	115 mm	Rated Input Voltage	12-48 V/DC
Width	57 mm	Control	RF 2,4 GHz
Height	25 mm	Channels	2

Article	Price
843057 ■	€ 109.95



Accessories

843065	RF White		€ 89.95
843015	Touch remote control RF White		€ 32.95
843013	Wall bracket remote control RF		€ 10.95



DEKO-LIGHT RF CONTROLLER SET RF COLOR



- for controlling RGB LED stripes
- Set comprises: Controller, remote control and wall bracket
- R/G/B dimmable as single colour
- 13 effect programs
- adjustable program speed
- max. eight remote controls/two touch panels for each system range
- Memory function
- Master/slave function
- not compatible with RF smart system
- Dimensions of controller L x W x H: 115 x 57 x 25 mm
- max. 5.0 A per channel
- Output:
 - 3 x 60 W (180 W) at 12 V DC
 - 3 x 120 W (360 W) at 24 V DC
 - 3 x 240 W (720 W) at 48 V DC

Housing	Plastic	Output Current	15 A
Length	115 mm	Rated Input Voltage	12-48 V/DC
Width	57 mm	Control	RF 2,4 GHz
Height	25 mm	Channels	3

Article	Price
843058 ■	€ 114.95



Accessories

843066	RF Color		€ 96.95
843016	Touch remote control RF Color		€ 32.95
843013	Wall bracket remote control RF		€ 10.95



DEKO-LIGHT RF CONTROLLER SET RF COLOUR + WHITE



- for controlling RGB and white LED strips
- Set consisting of controller, remote control, wall bracket
- RGB and white dimmable as individual colour
- 12 effect programs
- adjustable program speed
- max. eight remote controls/two touch panels for each system range
- Memory function
- Master/slave function
- not compatible with RF smart system
- Dimensions of controller L x W x H: 115 x 57 x 25 mm
- max. 5.0 A per channel
- Output:
 - 4 x 45 W (180 W) at 12 V DC
 - 4 x 90 W (360 W) at 24 V DC
 - 4 x 180 W (720 W) at 48 V DC

Housing	Plastic	Output Current	15 A
Length	115 mm	Rated Input Voltage	12-48 V/DC
Width	57 mm	Control	RF 2,4 GHz
Height	25 mm	Channels	4

Article	Price
843059 ■	€ 119.95



Accessories

843067	RF Color + White		€ 96.95
843017	Touch remote control RF Color + White		€ 32.95
843013	Wall bracket remote control RF		€ 10.95



SMART HOME CAN BE SO SIMPLE

Install the Casambi module in the distribution box, suspended ceiling or similar – install the app from the Playstore/iTunes, connect the module to your mobile phone and the app, set it up and off you go!



CASAMBI BLUETOOTH CBU-TED | 230 V SWITCHING/ DIMMING

- suitable for R loads [incandescent bulb, high-voltage halogen]
- suitable for C loads [dimmable high-voltage LED, electrical power supply units]
- Power in switching range: incandescent bulb, high-voltage halogen, high-voltage LED, electrical ballasts: max. 150W
- Power in the dimming range: dimmable high-voltage LED, electrical ballasts: max. 50W / max. two components
- Suitable for 230V AC luminaires
- Install Casambi module in the junction box, suspended ceiling or similar
- Control and configuration via smartphone app
- Smartphone app [Android and Apple] free of charge

Housing	Plastic	Power	1.0-50 W
Length	40.4 mm	Rated Input Voltage	220-240 V/AC
Width	36.3 mm	Control	Casambi
Height	14 mm	Channels	1

Article Price

843008 € 144.95



Lighting design

Interested in our lighting design service?

Your contact person will be happy to answer any questions you may have.



CASAMBI BLUETOOTH CBU-ASD | DALI/0-10 V | 1-10 V

- Module generates either DALI, 0-10 V or 1-10 V control signal
- Control signal for each ballast unit or power supply unit
- Install Casambi module in the junction box, suspended ceiling or similar
- Controlled and configured via smartphone app
- Free smartphone app (Android and Apple)

Housing	Plastic	Rated Input Voltage	220-240 V/AC
Length	56.5 mm	Control	Casambi
Width	35.8 mm	Channels	1
Height	22.3 mm		

Article Price

843011 **€ 149.95**



CASAMBI BLUETOOTH CBU-PWM4 | LED ONE-TO FOUR-CHANNEL DIMMER

- Module used to control 12 V/24 V LED strips
- 1-4 channels (WW, CW, WW-CW, RGB, RGBW)
- Output 144 W at 24 V, 72 W at 12 V
- Install the Casambi module in the junction box, suspended ceiling or similar
- Controlled and configured via smartphone app
- Free smartphone app (Android and Apple)

Housing	Plastic	Output Current	6 A
Length	72.6 mm	Rated Input Voltage	12-24 V/DC
Width	30 mm	Control	Casambi
Height	18 mm	Channels	1, 2, 3, 4

Article Price

843037 **€ 179.95**

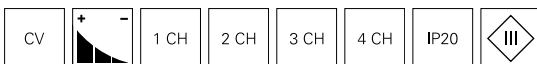



CASAMBI BLUETOOTH WALL-MOUNTED CONTROLLER XPRESS

- Bluetooth wall controller compatible with Casambi system
- Installation with screws or adhesive tape
- no cabling required
- battery operation (3 V button cell)
- Configuration via smartphone app
- Controlled via free smartphone app (Android and Apple)

Housing	Plastic	Height	12 mm
Length	90 mm	Rated Input Voltage	3 V/DC
Width	90 mm	Control	Casambi

Article		Price
843049	■	€ 399.95
843050	□	€ 399.95



Technical data sheet

New in the onlineshop: The technical data sheets offer even more information: Light and energy data, light distribution curves, dimensional drawings and more.



DEKO-LIGHT X-FADE-6

- Simple operation
- controls DMX512 PWM dimmer
- Scene memory
- Six individually programmable programmes with up to 100 steps
- Fade time setting
- many control options for single or WW-CW LED applications
- 6 individual faders for 1 control channel each (6x 1 channel, 3x 2 channel or mix)
- Additional fader for master brightness
- recessed wall mounting on 68 mm single switch box
- IR remote control included in the scope of delivery

Housing	Polycarbonate	Height	16.3 mm
Length	86 mm	Rated Input Voltage	12-24 V/DC
Width	86 mm	Channels	1, 2, 3, 4, 5, 6

Article Price

861203 **€ 199.95**

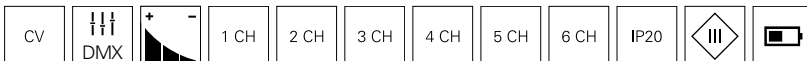

Accessories

872128 MINI, CV, 24V/4W



€ 12.95

843279 MULTI-LED-Dimmer 1-4 CH, DMX/AUTO/MAN, 12-48V, 20A



€ 114.95

843054 DMX/RDM 4 CH CC Decoder



€ 119.95



DEKO-LIGHT LED DMX TOUCH 16C

- Simple operation
- Group control
- Master control of all channels
- controls DMX512 PWM dimmer
- specially developed for 1 channel single LED strips / lights
- 1-4 zones with 4x 1 channel each
- up to 16 individually or in 4 groups controllable LED-Stripes
- Backlight and touch signal tone optionally switchable
- Memory function: memorises the last set brightness of all channels
- DMX output via CAT5 [RJ45] or connection terminals
- Automatic DMX address assignment [zone 1: address 1-4, zone 2: address: 5-8, zone 3: address: 9-12, zone 4: address: 13-16]
- Recessed wall mounting on 68mm single switch box

Housing	Glass	Height	17.4 mm
Length	86 mm	Rated Input Voltage	12-24 V/DC
Width	86 mm	Channels	1

Article Price

843001 **€ 119.95**



Accessories

872128 MINI, CV, 24V/4W



€ 12.95

843279 MULTI-LED-Dimmer 1-4 CH, DMX/AUTO/MAN, 12-48V, 20A



€ 114.95

843054 DMX/RDM 4 CH CC Decoder



€ 119.95



DEKO-LIGHT ART 4 | RGB/RGBW

- Simple touch operation and control via touchwheel
- ideal for hotels, auditoriums, home and living areas
- suitable for LED strips with 3-4 channels [RGB, RGBW]
- 1 zone
- Directly adjustable colours and brightness
- Selectable and editable automatic programmes
- Adjustable programme speed
- Stores up to 4 individual scenes/moods
- Fade times of 0-4 seconds possible
- connection terminals for DMX output, PWM and DC IN
- Integrated PWM dimmer 12V / 24V, 4 x 2A for direct connection of LED strips
- DMX output also controls external DMX PWM dimmers
- recessed wall mounting on 68 mm single switch box

Housing	Polycarbonate	Power	192 W
Length	86 mm	Rated Input Voltage	12-24 V/DC
Width	86 mm	Channels	3, 4
Height	15.3 mm		

Article Price

843000 **€ 229.95**

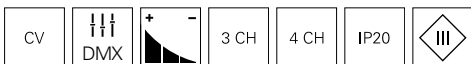

Accessories

872128 MINI, CV, 24V/4W



€ 12.95

843279 MULTI-LED-Dimmer 1-4 CH, DMX/AUTO/MAN, 12-48V, 20A



€ 114.95



DEKO-LIGHT ART 9 | RGB/RGBW

- Simple touch operation and control via touchwheel
- ideal for hotels, auditoriums, home and living areas
- suitable for LED strips with 3-4 channels [RGB, RGBW]
- Function memory and power failure protection
- 1 zone
- Directly adjustable colours and brightness
- Selectable and editable automatic programmes
- Adjustable programme speed
- Stores up to 9 individual scenes/moods
- Fade times of 0-4 seconds possible
- connection terminals for DMX output, PWM and DC IN
- Integrated PWM dimmer 12V / 24V, 4 x 2A for direct connection of LED strips
- DMX output also controls external DMX PWM dimmers
- recessed wall mounting on 68 mm single switch box

Housing	Polycarbonate	Power	192 W
Length	172 mm	Rated Input Voltage	12-24 V/DC
Width	86 mm	Channels	3, 4
Height	15.3 mm		

Article Price

843003 **€ 234.95**

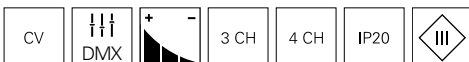

Accessories

872128 MINI, CV, 24V/4W



€ 12.95

843279 MULTI-LED-Dimmer 1-4 CH, DMX/AUTO/MAN, 12-48V, 20A



€ 114.95



DEKO-LIGHT TOUCH 16CH PRO

- Intuitive operation and programming via display
- Menu navigation via rotary wheel with push function
- Ideal for hotels, auditoriums, home and living areas
- suitable for LED strips with 1-4 channels [single, WW-CW, RGB, RGBW]
- up to 4 independent control zones
- Scene memory
- Colour mode for setting the colours of each zone individually
- Brightness mode for setting the brightness of each zone individually
- Program mode for individually setting the colour change and fader of each zone
- 14 pre-installed or eight customisable programmes can be assigned to a zone
- Time mode for setting the start and end time of set programmes
- Internal clock for time-dependent switching of zones with stored programmes
- Connection terminals for DMX output and DC IN
- recessed wall mounting on 68 mm single switch box

Housing	Aluminium	Height	15.3 mm
Length	86 mm	Rated Input Voltage	12-24 V/DC
Width	86 mm	Channels	1, 2, 3, 4

Article	Price
843004	€ 359.9

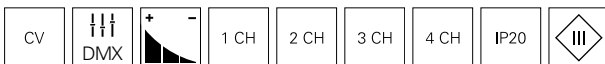

Accessories

872128 MINI, CV, 24V/4W



€ 12.95

843279 MULTI-LED-Dimmer 1-4 CH, DMX/AUTO/MAN, 12-48V, 20A



€ 114.95

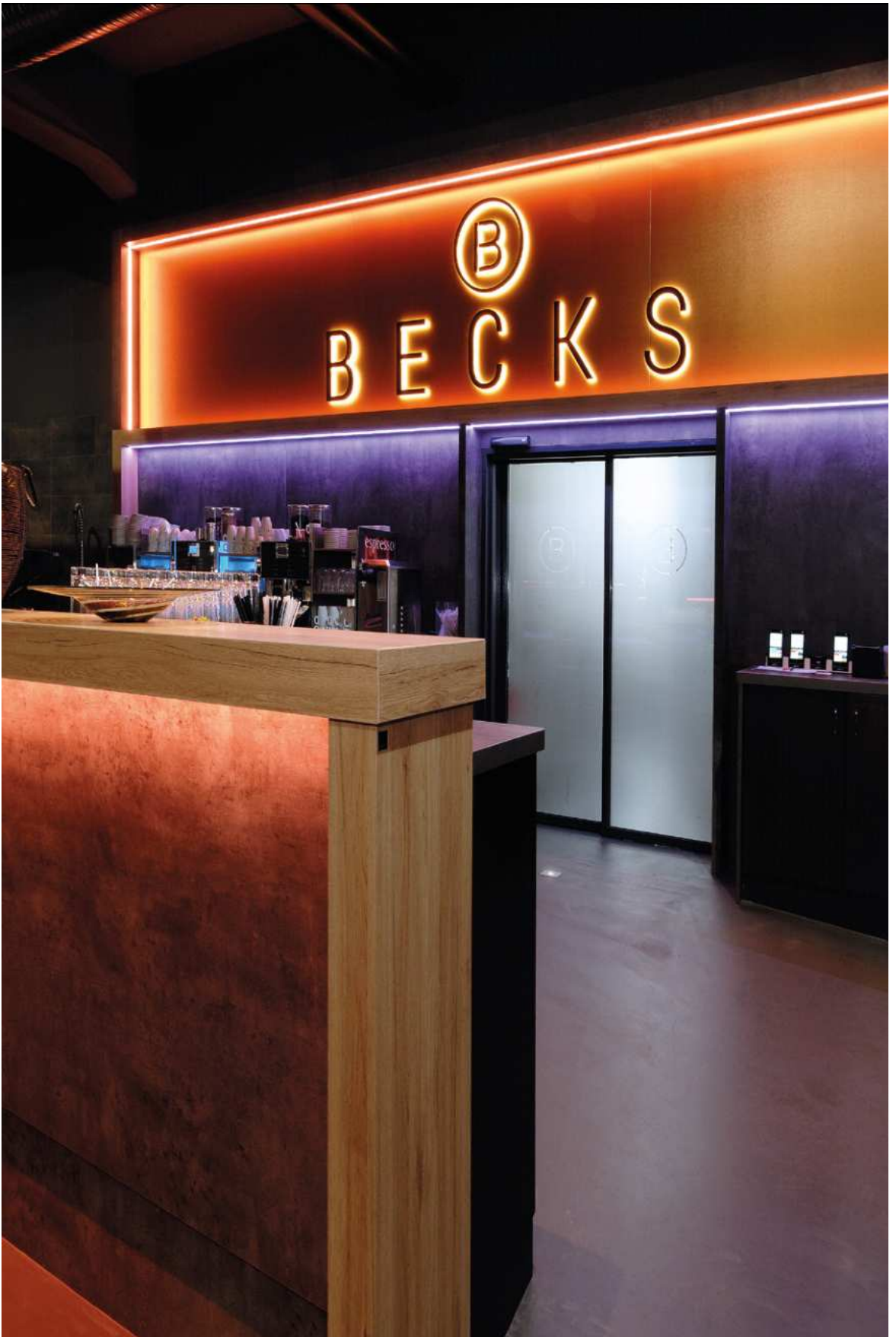

With the kind support of SH-Lichttechnik, Becks Reutlingen



EUROLITE DMX-CONTROLLER LED COLOR CHIEF



- Simple and intuitive DMX control and programming via display
- innovative lighting control for catering, bars, event locations, function rooms, etc.
- USB connection for data storage and restoration of programming as well as firmware update
- Up to 8 individually controllable zones / devices
- Simple control of LED strips, lights, spotlights, etc. with 1 to 6 colours or lighting effects with up to 30 channels
- Extensive, pre-installed device library with many common applications
- Additional devices can be easily added manually
- 8 colour effects can be selected directly
- 3 additional channels can be freely assigned per device [e.g. for special functions, movements, etc.]
- 24 memory locations for permanently stored lighting scenes (scene memory)
- Clock control for programmed running lights via music signal
- Function buttons for blackout, auto, music control and strobe effect
- Overall dimming, fade time between individual scenes conveniently adjustable
- 3-pin XLR connection
- Operation as rack-mounted [19" / 3 height units] or desktop unit
- Power supply via plug-in power supply unit (included)

Housing	Metal	Height	85 mm
Length	482 mm	Rated Input Voltage	100-240 V/AC
Width	132 mm	Channels	1, 2, 3, 4, 5, 6

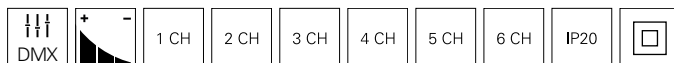
Article	Price
843047	€ 469.95



Accessories

882271	DMX adapter cable CAT5 auf DMX XLR plug		€ 54.95
930697	Data cable RJ45 for DMX dimmer, Type: Cat5e, 2m		€ 3.95
843279	MULTI-LED-Dimmer 1-4 CH, DMX/AUTO/MAN, 12-48V, 20A		€ 114.95



EUROLITE DMX CONTROLLER LED EASY DELUXE



- Simple and intuitive DMX control and programming
- innovative lighting control for catering, bars, event locations and function rooms
- Scene memory
- DMX control of max. 24 channels
- for up to 4 different device groups/zones
- 1-6 channels [RGB/W/CCT/A]
- Simple control of LED strips, lights, spotlights, etc. with one to 6 colours
- Quick and easy commissioning thanks to pre-installed programmes
- individual DMX channels for red, green, blue, white, amber and UV
- 12 memory locations for permanently stored lighting scenes
- 4 colour controllers with twelve colours each
- 4 brightness controls
- Function buttons for blackout, auto, music control and strobe effect
- Controls for overall brightness, sequence and fade time
- 3-pin XLR connection
- Operation as a built-in or table-top unit
- Power supply via plug-in power supply unit (included)

Housing	Metal	Height	65 mm
Length	260 mm	Rated Input Voltage	100-240 V/AC
Width	140 mm	Channels	1, 2, 3, 4, 5, 6

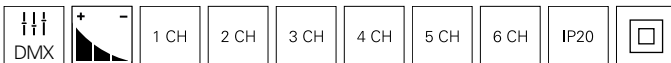
Article	Price
843046 ■	€ 239.95



Accessories

882271	DMX adapter cable CAT5 auf DMX XLR plug		€ 54.95
930697	Data cable RJ45 for DMX dimmer, Type: Cat5e, 2m		€ 3.95
843279	MULTI-LED-Dimmer 1-4 CH, DMX/AUTO/MAN, 12-48V, 20A		€ 114.95



DEKO-LIGHT MULTI-DIMMER 4, 4-CHANNEL 3-IN-1 CONTROL/PWM DIMMER

- Simple programming of all settings via display and four-button operating menu
- 3-in-1 control DMX/automatic/manual
- Use as 1, 2, 3 or 4 channel dimmer
- 24 preset colour change programs (automatic mode)
- all four channels can be dimmed individually (manual colour mixing)
- Flicker-free 2 kHz for image and video recording
- after power failure, dimmer automatically shows the last mode, program or colour setting
- DMX signal/master slave can be plugged in via CAT5
- max. 20 A (4 x 5 A per channel)
Output:
 - 4 x 60 W (240 W) at 12 V
 - 4 x 120 W (480 W) at 24 V
 - 4 x 240 W (960 W) at 48 V

Housing	Metal	Output Current	20 A
Length	116 mm	Rated Input Voltage	12-48 V/DC
Width	57 mm	Channels	1, 2, 3, 4
Height	26.8 mm		

Article Price

843279 ■ € 114.95

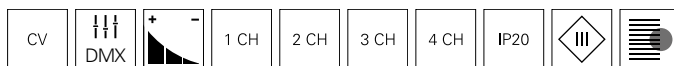

Accessories

930697 Data cable RJ45 for DMX dimmer, Type: Cat5e, 2m



€ 3.95



DEKO-LIGHT R-DMX 3+1

- meets DMX 512/1990, RDM protocol/2009
- supports automatic DMX addressing
- incl. top-hat rail adapter
- incl. 2 m CAT5 cable (RJ45)
- flicker-free
- Connection: Screw terminals
- max. 16 A (4 x 4 A per channel)
- Output:
 - 4 x 48 W (192 W) at 12 V
 - 4 x 96 W (384 W) at 24 V

Housing	Metal	Output Current	16 A
Length	120 mm	Rated Input Voltage	12-24 V/DC
Width	43 mm	Channels	1, 2, 3, 4
Height	23 mm		

Article	Price
843273	€ 86.95

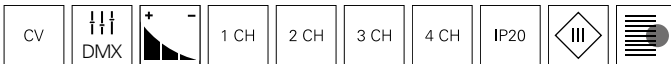

Accessories

930697 Data cable RJ45 for DMX dimmer, Type: Cat5e, 2m



€ 3.95



Lighting design

Interested in our lighting design service?
Your contact person will be happy to answer any questions you may have.



DEKO-LIGHT LED DMX DIMMER 2

- powerful 1-2 channel dimmer
- Controller: DMX, 0-10 V, manual, automatic
- Use as a stand-alone device or in conjunction with a DMX control panel
- flicker-free
- Connection: Screw terminals
- max. 12 A (2 x 6 A per channel)
- Output:
 - 2 x 72 W (144 W) at 12 V
 - 2 x 144 W (288 W) at 24 V

Housing	Plastic	Output Current	12 A
Length	115 mm	Rated Input Voltage	12-24 V/DC
Width	57 mm	Channels	1, 2
Height	25 mm		

Article Price

843336 **€ 79.95**

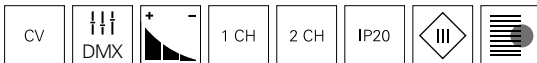



DEKO-LIGHT LED DMX DIMMER 4

- simple and powerful four-channel dimmer
- Controller: DMX, manual, automatic
- Use as a stand-alone device or in conjunction with a four-channel DMX wall controller
- flicker-free
- Connection: Screw terminals
- max. 12 A (4 x 3 A per channel)
- Output:
 - 4 x 36 W (144 W) at 12 V
 - 4 x 72 W (288 W) at 24 V

Housing	Plastic	Output Current	12 A
Length	115 mm	Rated Input Voltage	12-24 V/DC
Width	57 mm	Channels	1, 2, 3, 4
Height	25 mm		

Article Price

843337 **€ 86.95**

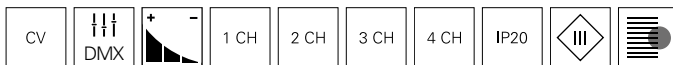



DEKO-LIGHT POWER SUPPLY UNITS CV DIM | HV DMX 2-IN-1

- Power supply unit + DMX dimmer in one device
- controllable with DMX
- integrated 3-channel DMX PWM dimmer
- suitable for 3x 1-channel single, 1x WW-CW or 1x RGB LED strip
- dimmable from 0 - 100%
- DMX connection via CAT5 pluggable
- Connection: screw terminals
- Short-circuit and overload-proof
- overheating protection

Housing	Metal	Height	40 mm
Power	135 W	Rated Input Voltage	100-240 V/AC
Length	196 mm	Channels	1, 2, 3
Width	75 mm	Mounting Location	Inside

Article		Output Voltage	Price
843274	■	12 V/DC	€ 139.95
843275	■	24 V/DC	€ 139.95

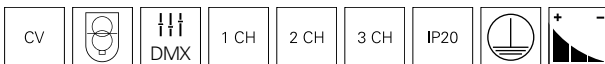

Accessories

930697 Data cable RJ45 for DMX dimmer, Type: Cat5e, 2m



€ 3.95



DECO-LIGHT LED DMX/R-DMX DIMMER 4 CC

- Simple programming of all settings via display and 4-button operating menu
- Controllable with DMX
- Use as 1-4 channel dimmer
- Controls 4 independent constant current [CC] LED lights via all common DMX and RDM DMX controllers
- Constant current for each channel individually adjustable from 200-1600mA in 50mA steps
- Output voltage for CC-compatible lights 1-42V
- Flicker-free 2kHz for image and video recordings
- Short-circuit and overload-proof
- Connection: screw terminals
- Power: max. 4x 60W

Housing	Metal	Output Current	200-1600 mA
Length	135 mm	Rated Input Voltage	12-50 V/DC
Width	69 mm	Channels	1, 2, 3, 4
Height	36 mm		

Article Price

843054 **€ 119.95**

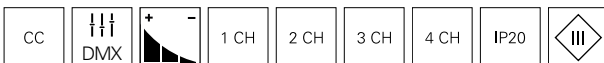

Technical data sheet

New in the onlineshop: The technical data sheets offer even more information: Light and energy data, light distribution curves, dimensional drawings and more.



DALI TRIAC DIMMER

- controllable with DALI1 / DALI2, DT6, 1 channel
- alternatively controllable with push-dim button [8-230 V/AC]
- Brightness dimmable / phase cut-off
- Adjustable minimum brightness [only with Push-Dim]
- Ideal for DALI extension or installation in triac dimmable luminaires due to small size
- LED output [C load] max. 200W / 230V / max. 10x LM or ballasts
- Halogen output [R load] 400W / 230V no limit on the number of light sources
- Current consumption on the Dali bus: max. 2 mA

Length	45.5 mm	Rated Input Voltage	100-240 V/AC
Width	45.5 mm	Control	DALI 1 / DT6, DALI 2 / DT6, Push-Dim
Height	20.3 mm	Channels	1
Power	1.0-400 W		
Output Current	1.8 A		

Article	Price
843340 <input type="checkbox"/>	€ 74.95

1 CH

IP20

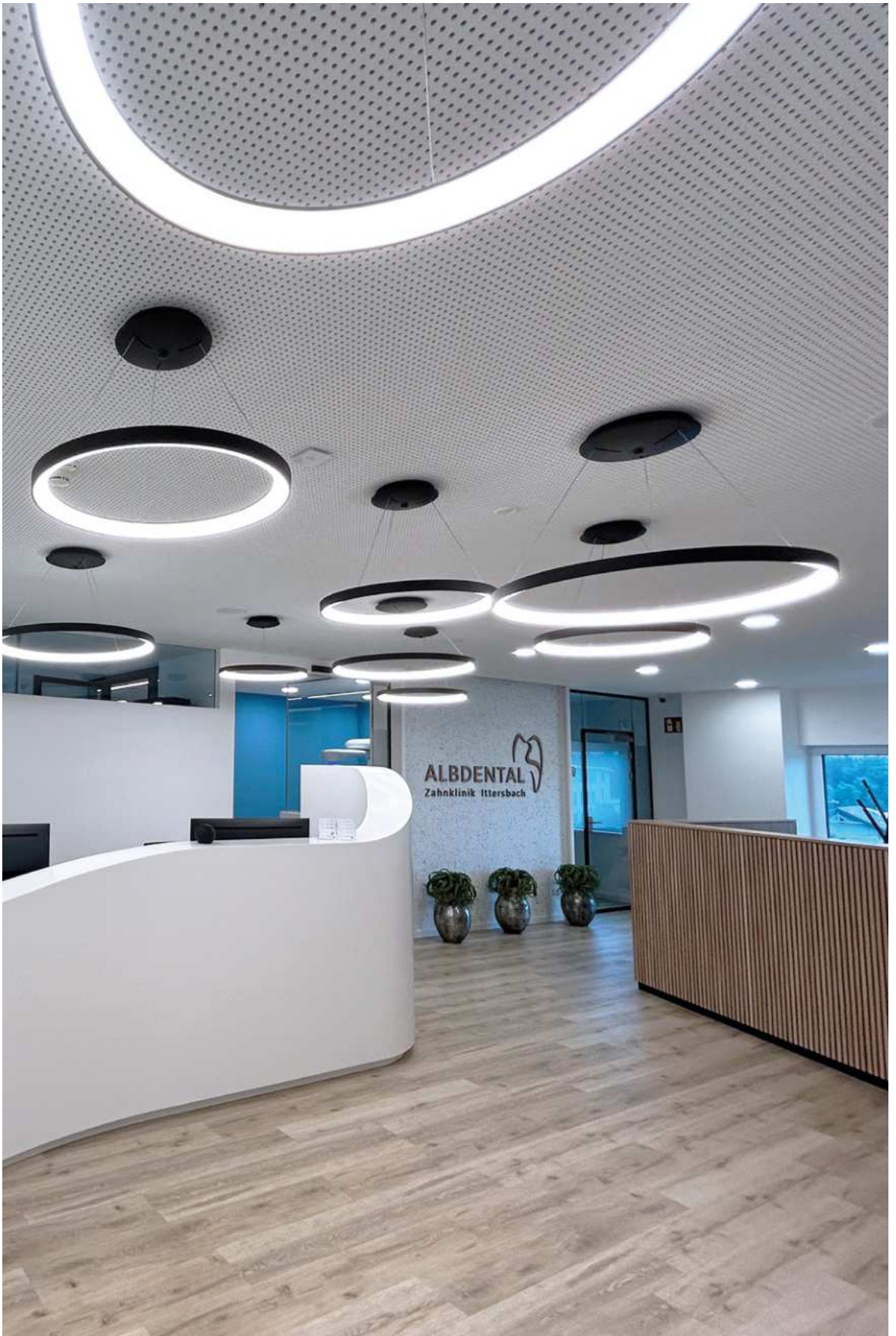



DEKO-LIGHT DALI LED PWM DIMMER 12-48 V, 1/2 CHANNEL

- DT6 = occupies 2 Dali channels
- 2x 1 channel mode (WW/CW) or 1x 2 channel mode (WW-CW, CCT)
- dimmable 0-100%, overload protection, reverse polarity protection
- Flickerfree, suitable for video recordings (PWM 2kHz)
- for 12V-48V DC (CV) LED strips/lights
- Output power 2x 8A = 16A

Housing	Plastic	Rated Input Voltage	12-48 V/DC
Length	167 mm	Control	DALI 1 / DT6, DALI 2 / DT6
Width	51 mm	Channels	1, 2
Height	23 mm		
Output Current	16 A		

Article Price

843341 € 84.95

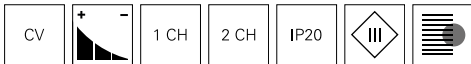

DEKO-LIGHT DALI DT8 LED PWM DIMMER 12-48 V, 2 CHANNEL

- DT8 = occupies 1 Dali channel
- 1x 2 channel mode (WW-CW, CCT)
- dimmable 0-100%, overload protection, reverse polarity protection
- Flickerfree, suitable for video recordings (PWM 2kHz)
- for 12V-48V DC (CV) LED strips/lights
- Output power 2x 8A = 16A

Housing	Plastic	Rated Input Voltage	12-48 V/DC
Length	167 mm	Control	DALI 1 / DT8, DALI 2 / DT8
Width	51 mm	Channels	2
Height	23 mm		
Output Current	16 A		

Article Price

843342 € 84.95





DEKO-LIGHT DALI LED PWM DIMMER 12-48 V, 3/4 CHANNEL

- DT6 = occupies 4 Dali channels
- 1x 3-channel mode (RGB) or 1x 4-channel mode (RGBW)
- dimnable 0-100%, overload protection, reverse polarity protection
- Flickerfree, suitable for video recordings (PWM 2kHz)
- for 12V-48V DC (CV) LED strips/lights
- Output power 4x 4A = 16A

Housing	Plastic	Rated Input Voltage	12-48 V/DC
Length	167 mm	Control	DALI 1 / DT6, DALI 2 / DT6
Width	51 mm	Channels	1, 2, 3, 4
Height	23 mm		
Output Current	16 A		

Article Price

843343 € 94.95

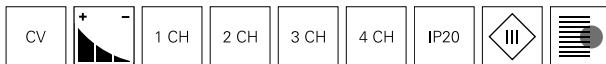

DEKO-LIGHT DALI DT8 LED PWM DIMMER 12-48 V, 4 CHANNEL

- DT8 = occupies 1 Dali channel
- 1x 4 channel mode (RGBW)
- dimnable 0-100%, overload protection, reverse polarity protection
- Flickerfree, suitable for video recordings (PWM 2kHz)
- for 12V-48V DC (CV) LED strips/lights
- Output power 4x 4A = 16A

Housing	Plastic	Rated Input Voltage	12-48 V/DC
Length	167 mm	Control	DALI 1 / DT8, DALI 2 / DT8
Width	51 mm	Channels	4
Height	23 mm		
Output Current	16 A		

Article Price

843344 € 94.95







ILLUMINANTS

- 866 G4 | G53 QR111
 - 868 MR16/GU5,3
 - 869 G9 | GU10
 - 873 E14
 - 874 E27
 - 884 R7s | GX53
- 



page 872



page 882



page 866



page 866



page 867



page 868



page 868



page 869



page 869



page 871



page 870



page 871

illuminant



page 873



page 873



page 875



page 875



page 876



page 876



page 877



page 877



page 878



page 878



page 879



page 879



page 880



page 880



page 884



page 884



OSRAM PARATHOM LED PIN G4

Housing	Plastic	Life Time L70 / B50	15000 h
Colour Temperature	2700 K	Length	36 mm
Luminous Flux	200 lm	Ø	13 mm
Power	1.8 W	Rated Input Voltage	12 V/AC/DC
Light Beam Angle	320 Degree	Colour Rendering Index (Ra)	80
Power Consumption	2 kWh/1000h		

Article	Housing Color		Price
180213	<input checked="" type="checkbox"/> Colourless		€ 8.95

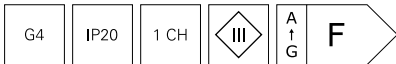

PHILIPS COREPRO LEDCAPSULE G4

Housing	Plastic	Life Time L70 / B50	15000 h
Colour Temperature	2700 K	Length	40 mm
Luminous Flux	315 lm	Ø	15 mm
Power	2.7 W	Rated Input Voltage	12 V/AC
Light Beam Angle	300 Degree	Colour Rendering Index (Ra)	80
Power Consumption	3 kWh/1000h		

Article	Housing Color		Price
180193	<input checked="" type="checkbox"/> Colourless		€ 19.95

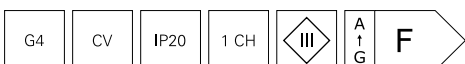



LEDVANCE LED AR111 DIMMABLE

Housing	Aluminium	Ø	111 mm
Luminous Flux	450 lm	Rated Input Voltage	12 V/AC/DC
Power	7.4 W	Colour Rendering Index (Ra)	90
Light Beam Angle	24 Degree	Control	Dimmable via optional power supply unit
Power Consumption	8 kWh/1000h		
Life Time L70 / B50	40000 h		
Length	55 mm		

Article	Housing Color	Colour Temperature	Price
180256	Grey	2700 K	€ 39.95
180257	Grey	3000 K	€ 39.95

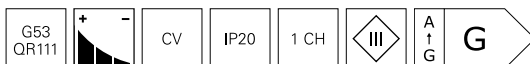

Technical data sheet

New in the onlineshop: The technical data sheets offer even more information: Light and energy data, light distribution curves, dimensional drawings and more.



LEDVANCE LED MR16

Housing	Glass	Ø	50 mm
Light Beam Angle	36 Degree	Rated Input Voltage	12 V/AC/DC
Life Time L70 / B50	15000 h	Colour Rendering Index (Ra)	80
Length	46 mm		

Article	Housing Color	Colour Temperature	Luminous Flux	Power	Power Consumption	EEL	Price
180254	<input checked="" type="checkbox"/> Colourless	3000 K	210 lm	2.6 W	3 kWh/1000h		€ 9.95
180258	<input checked="" type="checkbox"/> Colourless	3000 K	345 lm	3.8 W	4 kWh/1000h		€ 9.95
180183	<input checked="" type="checkbox"/> Colourless	4000 K	230 lm	2.6 W	3 kWh/1000h		€ 9.95
180259	<input checked="" type="checkbox"/> Colourless	4000 K	345 lm	3.8 W	4 kWh/1000h		€ 9.95

MR16 GU5,3 CV IP20 1 CH



LEDVANCE LED MR16 DIMMABLE

Housing	Glass	Rated Input Voltage	12 V/AC/DC
Light Beam Angle	36 Degree	Colour Rendering Index (Ra)	90
Life Time L70 / B50	25000 h	Control	Dimmable via optional power supply unit
Length	44 mm		
Ø	50 mm		

Article	Housing Color	Colour Temperature	Luminous Flux	Power	Power Consumption	Price
180263	<input checked="" type="checkbox"/> Colourless	3000 K	230 lm	3.4 W	4 kWh/1000h	€ 13.95
180255	<input checked="" type="checkbox"/> Colourless	3000 K	345 lm	5.0 W	5 kWh/1000h	€ 14.95
180266	<input checked="" type="checkbox"/> Colourless	3000 K	621 lm	8.0 W	8 kWh/1000h	€ 19.95
180264	<input checked="" type="checkbox"/> Colourless	4000 K	230 lm	3.4 W	4 kWh/1000h	€ 13.95
180265	<input checked="" type="checkbox"/> Colourless	4000 K	345 lm	5.0 W	5 kWh/1000h	€ 14.95

MR16 GU5,3 CV IP20 1 CH



LEDVANCE LED P PIN G9

Housing	Plastic	Rated Input Voltage	220-240 V/AC
Colour Temperature	2700 K	Colour Rendering Index (Ra)	80
Light Beam Angle	360 Degree		
Life Time L70 / B50	15000 h		

Article	Housing Color	Luminous Flux	Power	Power Consumption	Height	Ø	EI	Price
180267	<input checked="" type="checkbox"/> Colourless	200 lm	1.9 W	2 kWh/1000h	46 mm	15 mm		€ 7.95
180268	<input checked="" type="checkbox"/> Colourless	320 lm	2.6 W	3 kWh/1000h	47 mm	15 mm		€ 9.95
180269	<input checked="" type="checkbox"/> Colourless	470 lm	4.2 W	5 kWh/1000h	52 mm	19 mm		€ 12.95



LEDVANCE LED GU10

Housing	Glass	Life Time L70 / B50	15000 h
Colour Temperature	2700 K	Length	54 mm
Luminous Flux	350 lm	Ø	50 mm
Power	4.3 W	Rated Input Voltage	220-240 V/AC
Light Beam Angle	36 Degree	Colour Rendering Index (Ra)	80
Power Consumption	5 kWh/1000h		

Article	Housing Color	Price
180275	<input type="checkbox"/> Silver	€ 6.95

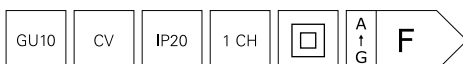



PHILIPS MASTER VALUE LED GU10 DIMMABLE

Housing	Glass	Colour Rendering Index (Ra)	90
Life Time L70 / B50	25000 h	Control	Trailing-edge dimmer
Length	54 mm	Channels	1
Ø	50 mm		
Rated Input Voltage	220-240 V/AC		

Article	Housing Color	Colour Temperature	Luminous Flux	Power	Light Beam Angle	Power Consumption	Price
180209	Silver	2700 K	270 lm	3.7 W	36 Degree	4 kWh/1000h	€ 13.95
180208	Silver	2700 K	355 lm	4.8 W	36 Degree	5 kWh/1000h	€ 14.95
180049	Silver	2700 K	355 lm	4.9 W	60 Degree	5 kWh/1000h	€ 14.95
180099	Silver	3000 K	365 lm	4.9 W	36 Degree	5 kWh/1000h	€ 14.95
180050	Silver	3000 K	365 lm	4.9 W	60 Degree	5 kWh/1000h	€ 14.95
180139	Silver	3000 K	575 lm	6.2 W	36 Degree	7 kWh/1000h	€ 20.95
180053	Silver	4000 K	380 lm	4.9 W	36 Degree	5 kWh/1000h	€ 14.95
180051	Silver	4000 K	380 lm	4.9 W	60 Degree	5 kWh/1000h	€ 14.95
180149	Silver	4000 K	575 lm	6.2 W	36 Degree	7 kWh/1000h	€ 20.95

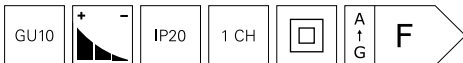



OSRAM PARATHOM LED GU10 DIMMABLE

Housing	Glass	Ø	50 mm
Colour Temperature	2700 K	Rated Input Voltage	220-240 V/AC
Luminous Flux	575 lm	Colour Rendering Index (Ra)	90
Power	8.3 W	Control	Trailing-edge dimmer
Light Beam Angle	60 Degree	Channels	1
Power Consumption	9 kWh/1000h		
Life Time L70 / B50	15000 h		
Length	52 mm		

Article	Housing Color		Price
180276	Silver	ww	€ 14.95

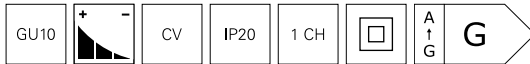

PHILIPS MASTER VALUE DT LED GU10 DIM-TO-WARM

Housing	Glass	Rated Input Voltage	220-240 V/AC
Colour Temperature	2000-2700 K	Colour Rendering Index (Ra)	90
Light Beam Angle	36 Degree	Control	Trailing-edge dimmer
Life Time L70 / B50	25000 h	Channels	1
Length	54 mm		
Ø	50 mm		

Article	Housing Color		Luminous Flux	Power	Power Consumption	Price
180212	Silver	ww	270 lm	3.7 W	4 kWh/1000h	€ 14.95
180113	Silver	ww	355 lm	4.9 W	5 kWh/1000h	€ 16.95

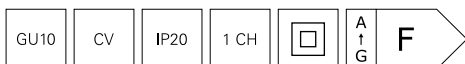



DEKO-LIGHT RF-SMART LAMP GU10 RGB+CCT WITH RF-CONTROL

- Brightness and colour saturation can be adjusted
- 16 million available colours and adjustable colour temperature
- 18 automatic programmes pre-installed
- Programme and remote control synchronisation when operating multiple RF-smart components (repeater function)
- Can be controlled with RF-smart wireless remote controls (2.4 GHz, range approx. 30 m, not included in the scope of delivery)
- Can only be controlled with RF remote controls [no Zigbee functionality]

Housing	Plastic	Length	57 mm
Colour Temperature	2700-6500 K	Ø	50 mm
Luminous Flux	300 lm	Rated Input Voltage	100-240 V/AC
Power	4 W	Colour Rendering Index (Ra)	80
Light Beam Angle	25 Degree	Control	RF-Smart
Power Consumption	4 kWh/1000h	Channels	5
Life Time L70 / B50	50000 h		

Article	Housing Color	Colour Temperature	Price
843515	<input type="checkbox"/> White	2700-6500 K	€ 34.95



Accessories

843510	RF-smart, remote control, white, 1 zone, RGB/RGBW/RGB+CCT, IP20		€ 38.95
843511	RF-smart, remote control, black, 1 zone, RGB/RGBW/RGB+CCT, IP20		€ 38.95
843512	RF-smart, remote control, black, 8 zones, Single/CCT/RGB/RGBW/RGB+CCT		€ 49.95
843513	RF-smart, wall remote control, white, 3V, 4 zones, Single/CCT/RGB/W/+CCT		€ 69.95
843522	RF-smart, wall remote control, white, 230V, 4 zones, Single/CCT/RGB/W/+CCT		€ 74.95
843514	RF-smart, wall remote control, white, 8 zones, Single/CCT/RGB/RGBW/RGB+CCT		€ 109.95



PHILIPS COREPRO LEDCANDLE E14

Housing	Glass	Life Time L70 / B50	15000 h
Colour Temperature	2700 K	Height	97 mm
Luminous Flux	470 lm	Ø	35 mm
Power	4.3 W	Rated Input Voltage	220-240 V/AC
Light Beam Angle	270 Degree	Colour Rendering Index (Ra)	80
Power Consumption	5 kWh/1000h		

Article	Housing Color		Price
180238	<input checked="" type="checkbox"/> Colourless	ww	€ 9.95

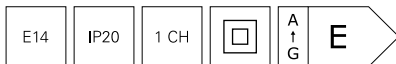

PHILIPS CLASSIC LEDCANDLE E14 DIM-TO-WARM

Housing	Glass	Length	97 mm
Colour Temperature	2200-2700 K	Ø	35 mm
Luminous Flux	470 lm	Rated Input Voltage	220-240 V/AC
Power	3.4 W	Colour Rendering Index (Ra)	90
Light Beam Angle	270 Degree	Control	Trailing-edge dimmer
Power Consumption	4 kWh/1000h		
Life Time L70 / B50	25000 h		

Article	Housing Color	Colour Temperature	Price
180248	<input checked="" type="checkbox"/> Colourless	ww 2200-2700 K	€ 13.95

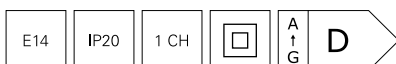



DEKO-LIGHT LED DESIGN-BULB ORBIT E27 DIMMABLE

Let our new ORBIT, SHINE and MOON designer luminaire series transport you into a world of style. The filigree light body and the reflections created in the glass give the impression of floating light. Whether light and airy in the living room at home or opulent and spacious in the hotel lobby - the dimmable LED lamps in the Design Bulb series are perfect for open luminaires without shades or lampholder luminaires with an E27 socket and are a real eye-catcher wherever they are used.



DEKO-LIGHT LED DESIGN-BULB ORBIT E27 DIMMABLE

Housing	Glass	Life Time	20000 h
Light Beam Angle	330 Degree	Control	Trailing-edge dimmer
Height	120 mm		
Ø	220 mm	Channels	1
Rated Input Voltage	220-240 V/AC		

Article	Housing Color	Colour Temp.	Luminous Flux	Power	Power Consumption	CRI (Ra)	EEL	Price
180731	Gold	1900 K	185 lm	4.5 W	5 kWh/1000h	85		€ 129.95
180730	Gold	2200 K	240 lm	4.0 W	4 kWh/1000h	90		€ 129.95

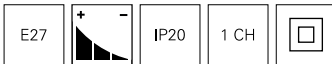

DEKO-LIGHT LED DESIGN BULB SHINE E27 DIMMABLE

Housing	Glass	Rated Input Voltage	220-240 V/AC
Light Beam Angle	330 Degree	Life Time	20000 h
Power Consumption	5 kWh/1000h	Control	Trailing-edge dimmer
Height	190 mm		
Ø	200 mm	Channels	1

Article	Housing Color	Colour Temp.	Luminous Flux	Power	CRI (Ra)	EEL	Price
180733	Gold	1900 K	210 lm	5 W	85		€ 114.95
180732	Gold	2200 K	300 lm	4.5 W	90		€ 114.95





DEKO-LIGHT LED DESIGN BULB MOON E27 DIMMABLE

Housing	Glass	Life Time	20000 h
Colour Temperature	1900 K	Control	Trailing-edge dimmer
Light Beam Angle	330 Degree	Channels	1
Rated Input Voltage	220-240 V/AC		
Colour Rendering Index (Ra)	85		

Article	Housing Color	Luminous Flux	Power	Power Consumption	Height	Ø	Price
180734	Gold	220 lm	6.0 W	6 kWh/1000h	165 mm	125 mm	€ 69.95
180735	Gold	260 lm	6.0 W	6 kWh/1000h	185 mm	150 mm	€ 79.95
180736	Gold	300 lm	6.0 W	6 kWh/1000h	230 mm	200 mm	€ 109.95
180737	Gold	350 lm	8.0 W	8 kWh/1000h	320 mm	300 mm	€ 249.95



PHILIPS MAS VLE E27 ST64 DIMMABLE

Housing	Glass	Control	Trailing-edge dimmer
Light Beam Angle	330 Degree	Channels	1
Life Time L70 / B50	15000 h		
Rated Input Voltage	220-240 V/AC		

Article	Housing Color	Colour Temperature	Luminous Flux	Power	Power Consumption	Height	EEL	Price
180359	Gold	1800 K	250 lm	4.0 W	4 kWh/1000h	143 mm		€ 39.95
180360	Colourless	2700 K	806 lm	5.9 W	6 kWh/1000h	140 mm		€ 21.95





PHILIPS COREPRO LEDBULB E27 A60 DIMMABLE

Housing	Glass	Ø	60 mm
Colour Temperature	2700 K	Rated Input Voltage	220-240 V/AC
Luminous Flux	470 lm	Colour Rendering Index (Ra)	90
Power	3.4 W	Control	Trailing-edge dimmer
Light Beam Angle	150 Degree	Channels	1
Power Consumption	4 kWh/1000h		
Life Time L70 / B50	15000 h		
Length	104 mm		

Article	Housing Color		Price
180214	<input type="checkbox"/> White	ww	€ 12.95

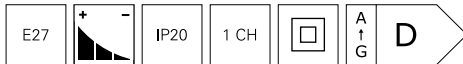

LEDVANCE LED RETROFIT E27 A60 DIMMABLE

Housing	Glass	Length	105 mm
Colour Temperature	2700 K	Rated Input Voltage	220-240 V/AC
Luminous Flux	805 lm	Colour Rendering Index (Ra)	80
Power	7 W	Control	Trailing-edge dimmer
Light Beam Angle	320 Degree	Channels	1
Power Consumption	7 kWh/1000h		
Life Time L70 / B50	15000 h		

Article	Housing Color		Price
180253	<input checked="" type="checkbox"/> Colourless	ww	€ 8.95

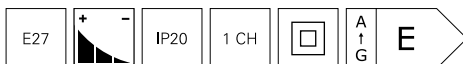



LEDVANCE LED CLASSIC E27 A75 DIMMABLE

Housing	Glass	Ø	60 mm
Colour Temperature	2700 K	Rated Input Voltage	220-240 V/AC
Luminous Flux	1055 lm	Colour Rendering Index (Ra)	80
Power	7.5 W	Control	Trailing-edge dimmer
Light Beam Angle	360 Degree	Channels	1
Power Consumption	8 kWh/1000h		
Life Time L70 / B50	15000 h		
Height	105 mm		

Article	Housing Color		Price
180277	<input checked="" type="checkbox"/> Colourless		€ 12.95

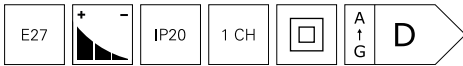

PHILIPS COREPRO LED BULB E27 A67

Colour Temperature	2700 K	Height	121 mm
Luminous Flux	2000 lm	Ø	70 mm
Power	13 W	Rated Input Voltage	220-240 V/AC
Light Beam Angle	330 Degree	Colour Rendering Index (Ra)	80
Power Consumption	13 kWh/1000h		
Life Time L70 / B50	15000 h		

Article	Housing Color		Price
180363	<input checked="" type="checkbox"/> Colourless		€ 19.95
180364	<input checked="" type="checkbox"/> Colourless		€ 19.95

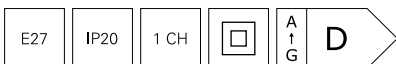



LEDVANCE LED CLA150 E27 DIMMABLE

Housing	Glass	Ø	70 mm
Colour Temperature	2700 K	Rated Input Voltage	220-240 V/AC
Luminous Flux	2452 lm	Colour Rendering Index (Ra)	80
Power	18 W	Control	Trailing-edge dimmer
Light Beam Angle	330 Degree	Channels	1
Power Consumption	18 kWh/1000h		
Life Time L70 / B50	15000 h		
Height	141 mm		

Article Housing Color Price

180361 Colourless **€ 27.95**

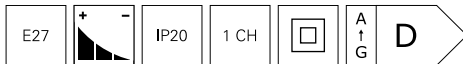

PHILIPS CLASSIC LEDLUSTER E27 P45 DIM-TO-WARM

Housing	Glass	Colour Rendering Index (Ra)	90
Light Beam Angle	270 Degree	Control	Trailing-edge dimmer
Life Time L70 / B50	25000 h	Channels	1
Length	78 mm		
Ø	45 mm		
Rated Input Voltage	220-240 V/AC		

Article Housing Color Colour Temperature Luminous Flux Power Power Consumption Price

180245 Colourless 2000-2700 K 470 lm 3.5 W 4 kWh/1000h **€ 13.95**

180279 Colourless 2200-2700 K 340 lm 2.5 W 3 kWh/1000h **€ 12.95**

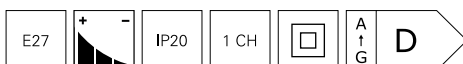



LEDVANCE LED STICK70 E27 DIMMABLE

Housing	Plastic	Ø	40 mm
Colour Temperature	2700 K	Rated Input Voltage	220-240 V/AC
Luminous Flux	1000 lm	Colour Rendering Index (Ra)	90
Power	11 W	Control	Trailing-edge dimmer
Light Beam Angle	200 Degree	Channels	1
Power Consumption	11 kWh/1000h		
Life Time L70 / B50	25000 h		
Height	117 mm		

Article	Housing Color		Price
180362	Colourless		€ 15.95

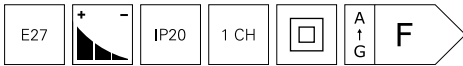

PHILIPS MASTER LEDSPOT E27 PAR 30 DIMMABLE

Housing	Glass	Rated Input Voltage	220-240 V/AC
Power	9.5 W	Colour Rendering Index (Ra)	90
Light Beam Angle	25 Degree	Control	Trailing-edge dimmer
Power Consumption	10 kWh/1000h	Channels	1
Life Time L70 / B50	25000 h		
Length	86 mm		

Article	Colour Temperature	Luminous Flux	Ø	Dimmable	Price
180278	3000 K	760 lm	95 mm		€ 42.95
180249	4000 K	820 lm	96 mm	Yes	€ 42.95

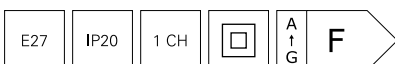



DEKO-LIGHT RF SMART LAMP E27 A60 RGB+CCT RF-CONTROLLABLE

- Dimmable brightness and colour saturation
- 16 million colours and adjustable colour temperature
- 18 pre-installed automatic programs
- Program and remote control synchronisation when operating multiple RF smart lamps (repeater function)
- can be controlled with RF-SMART wireless remote controls (2.4 GHz, range approx. 30 m, not included in the scope of delivery)
- can only be controlled with RF remote controls (no Zigbee functionality)







Housing	Plastic	Ø	57 mm
Luminous Flux	550 lm	Rated Input Voltage	100-240 V/AC
Power	6 W	Colour Rendering Index (Ra)	80
Light Beam Angle	220 Degree	Control	RF-Smart
Power Consumption	6 kWh/1000h	Channels	5
Life Time L70 / B50	50000 h		
Length	100 mm		

Article Housing Color Colour Temperature Price

843516 White  2700-6500 K **€ 34.95**



Accessories

843510	RF-smart, remote control, white, 1 zone, RGB/RGBW/RGB+CCT, IP20		€ 38.95
843511	RF-smart, remote control, black, 1 zone, RGB/RGBW/RGB+CCT, IP20		€ 38.95
843512	RF-smart, remote control, black, 8 zones, Single/CCT/RGB/RGBW/RGB+CCT		€ 49.95
843513	RF-smart, wall remote control, white, 3V, 4 zones, Single/CCT/RGB/W/+CCT		€ 69.95
843522	RF-smart, wall remote control, white, 230V, 4 zones, Single/CCT/RGB/W/+CCT		€ 74.95
843514	RF-smart, wall remote control, white, 8 zones, Single/CCT/RGB/RGBW/RGB+CCT		€ 109.95



DEKO-LIGHT RF-SMART LAMP E27 MAX RGB+CCT WITH RF-CONTROL

- Brightness and colour saturation can be adjusted
- 16 million available colours and adjustable colour temperature
- 18 automatic programmes pre-installed
- Programme and remote control synchronisation when operating multiple RF-smart components (repeater function)
- Can be controlled with RF-smart wireless remote controls (2.4 GHz, range approx. 30 m, not included in the scope of delivery)
- Can only be controlled with RF remote controls [no Zigbee functionality]

Housing	Plastic	Ø	74 mm
Luminous Flux	1100 lm	Rated Input Voltage	100-240 V/AC
Power	12 W	Colour Rendering Index (Ra)	80
Light Beam Angle	220 Degree	Control	RF-Smart
Power Consumption	12 kWh/1000h	Channels	5
Life Time L70 / B50	50000 h		
Length	140 mm		

Article	Housing Color	Colour Temperature	Price
843517	<input type="checkbox"/> White	2700-6500 K	€ 64.95



Accessories

843510	RF-smart, remote control, white, 1 zone, RGB/RGBW/RGB+CCT, IP20		€ 38.95
843511	RF-smart, remote control, black, 1 zone, RGB/RGBW/RGB+CCT, IP20		€ 38.95
843512	RF-smart, remote control, black, 8 zones, Single/CCT/RGB/RGBW/RGB+CCT		€ 49.95
843513	RF-smart, wall remote control, white, 3V, 4 zones, Single/CCT/RGB/W/+CCT		€ 69.95
843522	RF-smart, wall remote control, white, 230V, 4 zones, Single/CCT/RGB/W/+CCT		€ 74.95
843514	RF-smart, wall remote control, white, 8 zones, Single/CCT/RGB/RGBW/RGB+CCT		€ 109.95

**Onlineshop**

You can find more information about the products in the onlineshop:
Detailed images, videos, project reports, LDT files, EPREL data sheets and more.



OSRAM HALOLINE R7S 78MM DIMMABLE

Housing	Glass	Colour Rendering Index (Ra)	100
Light Beam Angle	360 Degree	Control	Leading-edge dimmer, Trailing-edge dimmer
Length	74.9 mm		
Ø	12 mm		
Rated Input Voltage	220-240 V/AC		

Article	Housing Color	Colour Temperature	Luminous Flux	Power	Power Consumption	Price
332269	Colourless	2800 K	750 lm	48.0 W	48 kWh/1000h	€ 10.95
332270	Colourless	2950 K	1400 lm	80.0 W	80 kWh/1000h	€ 10.95
332271	Colourless	2950 K	2250 lm	120.0 W	120 kWh/1000h	€ 10.95

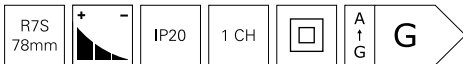

PHILIPS COREPRO LED R7S 118MM DIMMABLE

Housing	Plastic	Length	118 mm
Colour Temperature	3000 K	Ø	29 mm
Luminous Flux	1600 lm	Rated Input Voltage	220-240 V/AC
Power	14 W	Colour Rendering Index (Ra)	80
Light Beam Angle	360 Degree	Control	Leading-edge dimmer, Trailing-edge dimmer
Power Consumption	14 kWh/1000h		
Life Time L70 / B50	15000 h		

Article	Housing Color	Price
180097	Colourless	€ 45.95

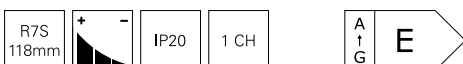



ISOLED LED GX53

Housing	Aluminium	Height	28 mm
Power	6 W	Ø	75 mm
Light Beam Angle	120 Degree	Rated Input Voltage	220-240 V/AC
Power Consumption	6 kWh/1000h	Colour Rendering Index (Ra)	80
Life Time L70 / B50	25000 h		

Article	Housing Color	Colour Temperature	Luminous Flux	Price
180196	<input type="checkbox"/> White	ww 3000 K	500 lm	€ 21.95
180195	<input type="checkbox"/> White	nw 4000 K	525 lm	€ 21.95

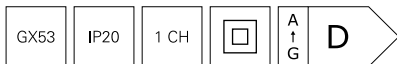

Lighting design

Interested in our lighting design service?

Your contact person will be happy to answer any questions you may have.



ACCESSORIES

- 890 indoor | dimming and switching
- 891 indoor | other
- 892 indoor | low voltage
- 896 outdoor | low voltage DC | WEIPU HQ plug-in connector
- 901 indoor | DMX cable
- 903 indoor | high voltage
- 906 indoor | high voltage | plug systems
- 908 outdoor | high voltage | plug systems
- 911 outdoor | cable connectors
- 916 mounting material for LED stripes and profiles
- 918 outdoor | mounting accessories
- 919 chemical products



□
page 890



□
page 890



■
page 891



□
page 892



□
page 893



□
page 894



page 896



■
page 902



■
page 905



■
page 906



■
page 909



■
page 914



■
page 915



page 917



■ ■
page 918



page 919



TRIAC-DIMMER TRAILING EDGE

suitable for dimming:

- **R loads (light bulb) 10-350 W**
- **C loads (electrical control gear) 10-350 W**
- **max. five control gears**
- **adjustable minimum load/brightness**
- **perfectly matched to DEKO-LIGHT power supply units**
- **suitable for 68 mm flush-mounted/cavity wall sockets**

Housing	Plastic	Power	355 W
Length	83.5 mm	Control	Trailing-edge dimmer
Width	83.5 mm		
Height	43.5 mm	Rated Current	1.6 A
Rated Input Voltage	220-240 V/AC	Connection Type	Clamp

Article	Housing Color	Price
---------	---------------	-------

930060	White	€ 66.95
---------------	-------	----------------



HIGH FREQUENCY MOTION SENSOR | MD1200

- **Detection angle: 360°**
- **Detection range: 1-10 m**
- **Switching time: 5 sec.-30 min.**
- **Daylight threshold value: 5-2,000 lux**
- **Suitable for switching all standard lamps/ballasts [RLC loads]**
- **Max. five ballasts**

Housing	Plastic	Rated Input Voltage	220-240 V/AC
Length	75 mm	Power	1200 W
Width	42 mm	Connection Type	Clamp
Height	28 mm		

Article	Housing Color	Price
---------	---------------	-------

930036	<input type="checkbox"/> White	€ 39.95
---------------	--------------------------------	----------------



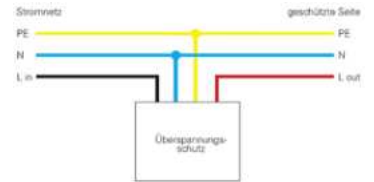

OVERVOLTAGE PROTECTION WITH CONTROL DISPLAY

- Compact protection for luminaires in the event of problems in the power grid
- Prevents premature failure
- in the event of a fault, the overvoltage protection is defective and thus protects the luminaire by disconnecting it from the mains
- Control LED to indicate the operating status
- Suitable for single-phase operated, non-dimmable luminaires
- With mounting bracket for mounting in luminaires or junction boxes

Housing	Plastic	Primary Connection End	With free strand / conductor ends
Length	37 mm	Secondary Connection End	Open cables
Width	30 mm	End	
Height	20 mm	Connection Type	Open cables
Rated Input Voltage	230-277 V/AC		
Rated Current	10 A		

Article	Housing Color	Price
843055	Black	€ 19.95

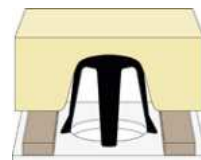

SAFETY SPACER

- for secure installation of downlights in ceilings with insulating material
- creates the required distance to the luminaire to allow better air circulation
- Observe the installation instructions for the respective luminaire.
- for recessed ceiling rings from Ø 62 to 90 mm

Housing	Plastic	Ø	62 mm
Height	80 mm		

Article	Housing Color	Price
829063	■ Black	€ 5.95



SOCKET GU5,3

- Heat-resistant connecting cable
- Ceramic socket

Housing	Ceramic	Secondary Connection End	Open cables
Rated Input Voltage	12 V/AC/DC	Connection Type	Open cables
Power	35 W		

Article	Housing Color	Length	Price
100200	<input type="checkbox"/> White	150 mm	€ 0.95
100250	<input type="checkbox"/> White	500 mm	€ 1.65

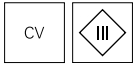

LOW-VOLTAGE SCREW DISTRIBUTOR AC SIX-WAY

- For rapid wiring of up to six voltage-stabilised [CV] components on one power supply unit
- 25 cm connecting cable

Housing	Plastic	Power	250 W
Length	63.5 mm	Connection Type	Open cables, Clamp
Width	26 mm		
Rated Input Voltage	12 V/AC		

Article	Housing Color	Price
930006	<input type="checkbox"/> White	€ 8.95





MINI-AMP CONNECTION CABLE

- Extends furniture lighting sets
- 2-pin/protected against reverse polarity
- Plug-and-play installation of pre-assembled components

Housing	Plastic	Connection Type	Mini AMP connector
Rated Input Voltage	12-24 V/DC		
Rated Current	3 A		

Article	Housing Color	Length	Price
940032	<input type="checkbox"/> White	300 mm	€ 2.95
940036	<input type="checkbox"/> White	1000 mm	€ 3.95
940040	<input type="checkbox"/> White	2000 mm	€ 4.95



MINI-AMP EXTENSION CABLE

- for extending the furniture light sets
- Plug-in installation of pre-assembled components
- 2-pole / reverse polarity protected

Housing	Plastic	Connection Type	Mini AMP connector
Rated Input Voltage	12-24 V/DC		
Rated Current	3 A		

Article	Housing Color	Length	Price
940044	<input type="checkbox"/> White	500 mm	€ 5.95
940048	<input type="checkbox"/> White	1000 mm	€ 6.95
940052	<input type="checkbox"/> White	2000 mm	€ 7.95





MINI-AMP MULTIPLE DISTRIBUTOR | PLUG - SOCKET

- Extends furniture lighting sets
- 2-pin/protected against reverse polarity
- Plug-and-play installation of pre-assembled components

Housing	Plastic	Rated Current	3 A
Length	38 mm	Connection Type	Mini AMP connector
Height	11 mm		
Rated Input Voltage	12-24 V/DC		

Article	Housing Color	Execution	Width	Price
940064	<input type="checkbox"/> White	3-way	32 mm	€ 6.95
940065	<input type="checkbox"/> White	6-way	58 mm	€ 7.95



MINI-AMP BUILT-IN SWITCH | PLUG - SOCKET

- Extends furniture lighting sets
- 2-pin/protected against reverse polarity
- Plug-and-play installation of pre-assembled components

Housing	Plastic	Rated Current	3 A
Length	1000 mm	Connection Type	Mini AMP connector
Rated Input Voltage	12-24 V/DC		

Article	Housing Color	Price
940066	<input type="checkbox"/> White	€ 12.95





MINI-AMP ADAPTER MR16/GU5,3 | SOCKET - PLUG

- Extends furniture lighting sets
- 2-pin/protected against reverse polarity
- Plug-and-play installation of pre-assembled components

Housing	Plastic	Rated Current	3 A
Length	500 mm	Connection Type	Mini AMP connector
Rated Input Voltage	12 V/DC		

Article	Housing Color	Price
940067	<input type="checkbox"/> White	€ 4.95

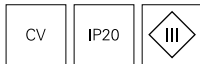



WEIPU HQ SOCKET / PLUG | 2-PIN

Housing Plastic Rated Current 8.5 A
 Rated Input Voltage 12-48 V/DC

Article	Connection Type	Price
940060	WEIPU plug 2-pole	€ 13.95
940058	WEIPU socket 2-pole	€ 13.95
940059	WEIPU socket 2-pole	€ 13.95



WEIPU HQ SOCKET / PLUG | 4-PIN

Housing Plastic Rated Current 8.5 A
 Rated Input Voltage 12-48 V/DC

Article	Connection Type	Price
940062	WEIPU plug 4-pole	€ 14.95
940061	WEIPU socket 4-pole	€ 14.95
940063	WEIPU socket 4-pole	€ 14.95





WEIPU HQ SOCKET / PLUG | 5-PIN

Housing	Plastic	Rated Input Voltage	12-48 V/DC
Length	65 mm	Rated Current	8.5 A
Height	25 mm		

Article	Connection Type	Price
940057	WEIPU plug 5-pole	€ 15.95
940056	WEIPU socket 5-pole	€ 15.95

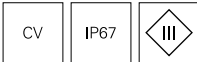

WEIPU HQ FEEDER CABLE | SOCKET 2-PIN

Housing	Plastic	Connection Type	WEIPU socket 2-pole
Rated Input Voltage	12-48 V/DC		
Rated Current	8.5 A		

Article	Length	Price
940037	1000 mm	€ 22.95
940038	3000 mm	€ 29.95
940039	5000 mm	€ 37.95

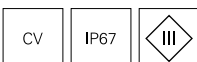



WEIPU HQ FEEDER CABLE | SOCKET 4-PIN

Housing	Plastic	Connection Type	WEIPU socket 4-pole
Rated Input Voltage	12-48 V/DC		
Rated Current	8.5 A		

Article	Length	Price
940033	1000 mm	€ 27.95
940034	3000 mm	€ 42.95
940035	5000 mm	€ 55.95



WEIPU HQ FEEDER CABLE | SOCKET | 5-PIN

Housing	Plastic	Connection Type	WEIPU socket 5-pole
Rated Input Voltage	12-48 V/DC		
Rated Current	8.5 A		

Article	Length	Price
940029	1000 mm	€ 31.95
940030	3000 mm	€ 47.95
940031	5000 mm	€ 59.95





WEIPU HQ CONNECTION CABLE | 2-PIN

Housing	Plastic	Secondary Connection	WEIPU socket
Rated Input Voltage	12-48 V/DC	End	2-pole
Rated Current	8.5 A	Connection Type	WEIPU plug 2-pole

Article	Length	Price
940049	1000 mm	€ 34.95
940050	3000 mm	€ 42.95
940051	5000 mm	€ 49.95



WEIPU HQ CONNECTION CABLE | 4-PIN

Housing	Plastic	Secondary Connection	WEIPU socket
Rated Input Voltage	12-48 V/DC	End	4-pole
Rated Current	8.5 A	Connection Type	WEIPU plug 4-pole

Article	Length	Price
940045	1000 mm	€ 42.95
940046	3000 mm	€ 56.95
940047	5000 mm	€ 68.95





WEIPU HQ CONNECTION CABLE | 5-PIN

Housing	Plastic	Secondary Connection End	WEIPU socket
Rated Input Voltage	12-48 V/DC	Connection Type	WEIPU plug 5-pole
Rated Current	8.5 A		

Article	Length	Price
940041	1000 mm	€ 47.95
940042	3000 mm	€ 60.95
940043	5000 mm	€ 72.95



WEIPU DISTRIBUTOR BOX

- for wiring 12V/24V/48V DC outdoor components
- reverse polarity protected
- Robust design
- 2 socket outlets

Housing	Plastic	Height	38 mm
Length	57 mm	Rated Input Voltage	12-48 V/DC
Width	57 mm	Rated Current	8.5 A

Article	Secondary Connection End	Connection Type	Price
730300	WEIPU socket 2-pole	WEIPU plug 2-pole	€ 64.95
730301	WEIPU socket 4-pole	WEIPU plug 4-pole	€ 68.95
940010	WEIPU socket 5-pole	WEIPU plug 5-pole	€ 78.95





CABLE SYSTEM, DMX

- Reverse polarity protected
- shielded cable
- RJ45 plug on both ends
- for quick connection of suitable DMX dimmers

Housing	Plastic	Secondary Connection End	RJ45 plug
Length	2000 mm	End	
Primary Connection End	RJ45 plug		

Article	Housing Color	Price
930697	 Grey	€ 3.95

IP20



DMX-ADAPTER CABLE | CAT5 AUF DMX XLR

- Reverse polarity protected
- Shielded cable
- for connecting DMX devices with suitable DMX dimmers
- Length 30 cm

Housing	Plastic	Primary Connection End	RJ45 plug
---------	---------	------------------------	-----------

Article	Housing Color	Secondary Connection End	Price
882271	 Black	XLR plug	€ 54.95
882272	 Black	XLR socket	€ 54.95

IP20



DMX-CONNECTION CABLE

- XLR cable
- reverse polarity protected
- shielded cable
- 3-pin plug / socket
- for quick connection of suitable DMX dimmers/devices

Housing Plastic Secondary Connection XLR socket
 Primary Connection End XLR plug End

Article	Housing Color	Length	Price
819066	■ Black	1000 mm	€ 9.95
819070	■ Black	5000 mm	€ 21.95
819072	■ Black	10000 mm	€ 34.95

IP20



CERAMIC CLAMPS

- 2-pin, with mounting hole
- Cables up to max. 2.5 mm²

Housing	Ceramic	Rated Input Voltage	12-230 V/AC
Length	21 mm	Rated Current	10 A
Width	18 mm	Connection Type	Clamp
Height	10 mm		

Article	Housing Color	Price
100301	<input type="checkbox"/> White	€ 2.25

IP20



SOCKET GU10 (PROTECTION CLASS II)

Housing	Ceramic	Primary Cable Length	15 cm
Length	150 mm	Primary Connection End	With free strand / conductor ends
Rated Input Voltage	220-240 V/AC		
Power	35 W		

Article	Housing Color	Price
100202	<input type="checkbox"/> White	€ 1.95

IP20



GU10



SOCKET GU10 (SAFETY CLASS I)

- with spacer and connection box
- Separate connection for protective conductor
- when used with installation rings, a screw connection between spacer and installation ring is required according to VDE

Housing	Ceramic	Power	35 W
Length	100 mm	Primary Cable Length	10 cm
Rated Input Voltage	220-240 V/AC	Primary Connection End	Screw terminal

Article	Housing Color	Price
100204	<input type="checkbox"/> White	€ 3.95



CONNECTING CABLE WITH 230 V MAINS PLUG

- for plug-in assembly of 230 V components
- H07RN-F cable, 3x 1.5 mm²
- Open cable ends

Housing	Plastic	Rated Current	16 A
Length	2950 mm	Primary Connection End	Power plug IP44
Width	10 mm	Secondary Connection	Open cables
Rated Input Voltage	220-240 V/AC	End	

Article	Housing Color	Price
930587	<input checked="" type="checkbox"/> Black	€ 19.95





DEKO-LIGHT QUICK CONNECTION BOX 2-WAY 230 V

- Fast through-wiring of power supplies or lamps
- Three-pin quick connection terminal for wires ranging from 0.5 to 1.5 mm² in size
- Pre-installed 3-pin cable measuring 15 cm for connection to SKI/SKII power supplies/lamps
- Quick-action fastener secured with additional screw
- For insertion into ceilings with round cut-outs of 68 mm and ceiling cavities of 25 mm or above

Housing	Plastic	Rated Current	16 A
Length	80 mm	Primary Connection End	Connection box
Width	40 mm		IP20
Height	25 mm	Secondary Connection End	Open cables
Rated Input Voltage	220-240 V/AC		

Article	Housing Color	Price
930694	■ Black	€ 5.95





WIELAND GST1813 PLUG | SOCKET | DISTRIBUTOR BLOCK

- 3-pole version
- for plug-in assembly of 230 V components
- for cable cross-sections 0.75 - 2.5 mm²

Housing	Plastic	Rated Current	16 A
Rated Input Voltage	220-240 V/AC		

Article	Housing Color	Length	Width	Height	Price
800115	■ Black	52.5 mm	32 mm	44 mm	€ 27.95
800100	■ Black	70 mm	28 mm	12 mm	€ 8.95
800105	■ Black	70 mm	28 mm	12 mm	€ 8.95



WIELAND GST1813 INFEEED CABLE WITH SAFETY PLUG

- 3-pole version
- for plug-in assembly of 230 V components
- Cable cross-section 3x 1.5 mm²

Housing	Plastic	Rated Current	16 A
Length	2000 mm	Primary Connection End	Power plug IP20
Rated Input Voltage	220-240 V/AC		

Article	Housing Color	Price
800116	■ Black	€ 19.95





WIELAND GST18I3 CONNECTION LINE WITH SOCKET | PLUG

- 3-pole version
- for plug-in assembly of 230V components
- Cable cross-section 3x 1.5 mm²

Housing	Plastic	Rated Input Voltage	220-240 V/AC
Width	28 mm	Rated Current	16 A
Height	12 mm	Connection Type	Open cables

Article	Housing Color	version	Length	Price
800109	■ Black	socket	1000 mm	€ 10.95
800112	■ Black	plug	1000 mm	€ 11.95
800111	■ Black	socket	3000 mm	€ 16.95
800114	■ Black	plug	3000 mm	€ 16.95



WIELAND GST18I3 EXTENSION LEAD

- 3-pole version
- Plug / socket
- for plug-in assembly of 230V components
- Cable cross-section 3x 1.5 mm²

Housing	Plastic	Rated Input Voltage	220-240 V/AC
Width	28 mm	Rated Current	16 A
Height	12 mm		

Article	Housing Color	Length	Price
800106	■ Black	1000 mm	€ 16.95
800107	■ Black	2000 mm	€ 18.95
800108	■ Black	3000 mm	€ 22.95





WIELAND RST2013 PLUG | SOCKET | DISTRIBUTOR BLOCK

- 3-pole version
- for cable cross-sections 1.5 mm² - 4.0 mm²
- for ready-to-plug-in assembly of 230 V outdoor components

Housing Plastic Rated Current 16 A
 Rated Input Voltage 220-240 V/AC

Article	Housing Color	version	Length	Width	Height	Ø	Price
800024	■ Black	plug	79 mm			34.7 mm	€ 16.95
800023	■ Black	socket	82 mm			34.7 mm	€ 16.95
800025	■ Black	distributor block, 1 input, 3 outputs	85.8 mm	31.3 mm	55.6 mm		€ 27.95



WIELAND RST2013 PROTECTIVE CAP

- For securely closing unused inputs/outputs

Housing Plastic Rated Input Voltage 220-240 V/AC

Article	Housing Color	version	Price
800026	Black	protective cap for plug	€ 3.95
800027	Black	protective cap for socket	€ 3.95





WIELAND RST2013 INFEEED CABLE WITH SAFETY PLUG

- 3-pole, high-voltage
- For cable cross-section 3 x 1.5 mm²
- Mains plug IP44/socket IP68

Housing	Plastic	Rated Current	16 A
Length	4000 mm	Primary Connection End	Power plug IP44
Rated Input Voltage	220-240 V/AC		

Article	Housing Color	Price
800028	■ Black	€ 69.95



WIELAND RST2013 CONNECTION LINE

- 3-pole version
- with socket and open end
- Cable H07RN-F3
- Cable cross-section 3x 1.5 mm²
- for plug-in assembly of 230V outdoor components

Housing	Plastic	Rated Current	16 A
Length	2000 mm	Primary Connection End	With free strand / conductor ends
Rated Input Voltage	220-240 V/AC		

Article	Housing Color	Price
800033	■ Black	€ 29.95





WIELAND RST20I3 CONNECTING CABLE SOCKET | PLUG

- 3-pole version
- Cable cross-section 3x 1.5 mm²
- Plug / socket
- for plug-in assembly of 230V outdoor components

Housing	Plastic	Rated Current	16 A
Rated Input Voltage	220-240 V/AC		

Article	Housing Color	Length	Price
800029	■ Black	2000 mm	€ 34.95
800036	■ Black	4000 mm	€ 48.95





OUTDOOR CABLE CONNECTOR GELBOX IPX8

- Set consisting of 2 gel boxes
- suitable for up to 5x 2.5 mm²
- for connecting low-voltage and 230V outdoor components
- Robust housing
- filled with silicone for optimum tightness

Housing	Silicone	Height	26 mm
Length	38 mm	Rated Input Voltage	12-450 V/AC
Width	30 mm		

Article	Housing Color	Price
930402	<input checked="" type="checkbox"/> Colourless	€ 28.95

IP68



MULTI OUTDOOR CABLE CONNECTOR | CONNECTION SLEEVE

- Watertight M25 cable glands
- For 2 cables measuring 4-14 mm
- For 2-5 wires measuring 0.5-4 mm²
- Adapter sleeves included in the scope of delivery

Housing	PA 6.6 - Polyamide 6.6	Height	32.56 mm
Length	112.53 mm	Rated Input Voltage	12-450 V/AC
Width	29.5 mm	Rated Current	24 A

Article	Housing Color	Price
930571	<input checked="" type="checkbox"/> Black, Yellow	€ 9.95

IP68
max.2m



MULTI OUTDOOR Y-SHAPED CABLE CONNECTOR | CONNECTION SLEEVE

- **Waterproof M25 cable glands**
- **For 3 cables measuring 4-14 mm [adapter sleeves included in the scope of delivery]**
- **For 2-3 wires measuring 0.5-4 mm²**

Housing	PA 6.6 - Polyamide 6.6	Height	32.56 mm
Length	139.71 mm	Rated Input Voltage	12-450 V/AC
Width	71.88 mm	Rated Current	24 A

Article	Housing Color	Price
930573	■ Black, Yellow	€ 10.95

IP68
max.2m



MULTI OUTDOOR CABLE DISTRIBUTOR TWO-WAY

- **For wiring low-voltage and 230 V outdoor components**
- **Robust housing**
- **Can be used in multiple ways thanks to the adapter sleeves included in the scope of delivery**
- **Watertight M20 cable glands**
- **For 2 cables measuring 5-12 mm [adapter sleeves included in the scope of delivery]**
- **For wires measuring 0.5-2.5 mm²**
- **Cover: Quick-action coupling [screwless]**

Housing	PA 6.6 - Polyamide 6.6	Ø	65.33 mm
Height	46.31 mm	Rated Input Voltage	12-450 V/AC
		Rated Current	24 A

Article	Housing Color	Price
930578	■ Black	€ 6.95

IP66



MULTI OUTDOOR CABLE DISTRIBUTOR TWO-WAY

- Watertight M20 cable glands
- For 2 cables measuring 5-12 mm
- Adapter sleeves included in the scope of delivery
- For wires 0.5-2.5 mm²
- Screwed cover [screws included in scope of delivery]

Housing	PA 6.6 - Polyamide 6.6	Height	42 mm
Length	125 mm	Rated Input Voltage	12-450 V/AC
Width	70 mm	Rated Current	24 A

Article	Housing Color	Price
930712	■ Black	€ 9.95

IP68
max.2m



MULTI OUTDOOR CABLE DISTRIBUTOR FOUR-WAY

- Watertight M25 cable glands
- For 2-4 cables measuring 4-14 mm
- Adapter sleeves included in scope of delivery
- For wires 0.5-4.0 mm²
- Screwed cover [screws included in scope of delivery]

Housing	PA 6.6 - Polyamide 6.6	Height	35.3 mm
Length	112.54 mm	Rated Input Voltage	12-450 V/AC
Width	93.3 mm	Rated Current	24 A

Article	Housing Color	Price
930575	■ Black	€ 11.95

IP68
max.2m



MULTI OUTDOOR CABLE DISTRIBUTOR FOUR-WAY

- Watertight M25 cable glands
- For 2-4 cables measuring 4-14 mm
- Adapter sleeves included in scope of delivery
- For wires 0.5-4.0 mm²
- Screwed cover [screws included in scope of delivery]

Housing	PA 6.6 - Polyamide 6.6	Height	35.3 mm
Length	112.54 mm	Rated Input Voltage	12-450 V/AC
Width	93.3 mm	Rated Current	24 A

Article	Housing Color	Price
930735	 Black	€ 19.95

IP68
max.2m



MULTI OUTDOOR SOCKET SLEEVE FOUR-WAY

- For wiring low-voltage and 230 V outdoor components
- Robust housing
- Spacious sleeve
- For 2 to 4 cables measuring 6-14 mm
- For wires up to 2.5 mm²
- FDM1: Resistant to humic acid and corrosion
- Quick-action coupling [screwless]
- Incl. 8 cable ties 150.00x2.20 mm

Housing	Plastic	Rated Input Voltage	12-450 V/AC
Length	190 mm	Rated Current	24 A
Ø	70 mm		

Article	Housing Color	Price
730275	 Black	€ 39.95

IP68
max.2m



MULTI OUTDOOR CABLE DISTRIBUTOR TEN-WAY

- Waterproof cable glands M25
- for two to ten cables 4-14 mm
- Adapter grommets and 8 blanking plugs included in the scope of delivery
- for wires 0.5-4 mm²
- Screwed cover [screws included]
- For wiring low-voltage and 230 V outdoor components
- Versatile use thanks to the adapter grommets supplied

Housing	PA 6.6 - Polyamide 6.6	Height	49.1 mm
Length	182.95 mm	Rated Input Voltage	12-450 V/AC
Width	135.3 mm	Rated Current	24 A

Article	Housing Color	Price
930574	■ Black	€ 39.95

IP68
max.2m



ASSEMBLY KIT FOR IP65/IP67 LED STRIPS

Set consisting of:

- 15 silicone retaining clips
- 30 stainless steel screws
- 5 end caps
- Supplied without silicone/adhesive

Housing

Silicone

Article	for stripes with outer dimension	Price
840293	11-12 mm	€ 4.95
840294	13-15 mm	€ 4.95
840295	17-19 mm	€ 4.95
840392	8-10 mm	€ 4.95





3M™ DOUBLE-SIDED ADHESIVE TAPE

- For installing aluminium profiles/LED strips on smooth surfaces
- Not suitable for IP65/67 silicone strips

Length 50 m Height 0.2 mm

Article	Width	Price
930345	8 mm	€ 27.95
930346	10 mm	€ 29.95
930347	12 mm	€ 31.95
930348	15 mm	€ 38.95
930349	20 mm	€ 48.95
930350	25 mm	€ 56.95



3M™ DOUBLE-SIDED ADHESIVE TAPE FOR SILICONE SURFACES

- Special adhesive tape for LED strips with silicone tube / full encapsulation
- high solvent resistance
- High temperature resistance
- High initial adhesion
- high adhesive strength on most silicone surfaces and difficult-to-bond substrates

Length 55 m Height 0.127 mm

Article	Width	Price
930405	10 mm	€ 209.95
930406	12 mm	€ 249.95



GROUND SPIKE WITH THREADED BUSHING

- Robust housing
- For anchoring surface-mounted spotlights in soil

Article	Housing Color	Thread Housing	Length	Ø	Price
930426	■ Black	M5 Aluminium	170 mm	33 mm	€ 9.95
700230	■ Black	M5 Plastic	200 mm	50 mm	€ 4.95
700229	■ Black	M6 Plastic	160 mm	43 mm	€ 4.95
730349	■ Black	M6 Plastic	210 mm	45 mm	€ 6.95
930427	■ Black	M10 Aluminium	219 mm	43.8 mm	€ 11.95



WALL BRACKET/DISPLAY ARM

- Robust housing
- Load capacity: max. 4.5 kg
- Ideal for illuminating advertising boards on façades
- Accessories for façade lighting
- Supplied without installation materials due to wide range of possible applications

Housing	Metal	Width	150 mm
Length	800 mm	Height	100 mm

Article	Housing Color	Price
930659	■ Black	€ 59.95



INSULATING SPRAY

- Spray can 400 ml
- Bonding to metal, glass, plastic, wood
- resistant to UV rays, acids, oils, alkaline solutions
- Protective cover for e.g. LED strips and electronic components

Height 205 mm Ø 68 mm

Article	Price
930663	€ 45.95



GEL ADHESIVE FOR BONDING END CAPS

- Cyanoacrylate instant adhesive
- 3 g tube
- Strong initial bond
- Excellent adhesion to almost all surfaces, such as metals, steel, stainless steel, zinc-plated steel, aluminium, plastics (e.g. ABS, GFRP, hard PC) and ceramic materials
- Curing time: 8-12 hours
- Observe the safety and application instructions

Article	Price
930593	€ 5.95



ASSEMBLY ADHESIVE

- Bond+Seal Power
- Cartridge, 310 ml
- Heavy-duty, elastic 1-component structural adhesive
- Excellent adhesion to almost all surfaces, such as metals, steel, stainless steel, zinc-plated steel, aluminium, plastics (e.g. ABS, GFRP, hard PVC) and ceramic materials
- UV-resistant
- Approved for use with foodstuffs according to NSF (NSF, P1 registered: 136996)
- High degree of initial strength
- Can be painted over with all commercially available paint systems (except alkyd resin paints)

Article	Price
930105	€ 35.95



NATURAL STONE SEALANT

- Cartridge 310 ml
- suitable for bonding profile covers and for use in wet rooms
- does not attack the surface of LED/strips
- Permanently elastic
- High weather, UV, ageing and colour resistance
- Excellently suited for heavy-duty outdoor use

Article	Price
930104	€ 39.95









SEALANT SMOOTHING AGENT

- Spray can 400 ml
- for clean stripping for all types of sealants [e.g. silicones, sealants e.g. silicones, polyurethane sealants etc.]
- easy application from the aerosol can
- Even cross-linking of the surface
- sealant joint hardens faster
- improves the surface

Article	Price
930103	€ 39.95



ELECTRIC CHARACTERISTICS

-  CV
constant voltage
-  CC
constant current
-  SELV
safety extra long voltage
-  flicker free
-  solar panel
-  USB charging socket
-  battery operation



LAMP

-  E27
base of lamp

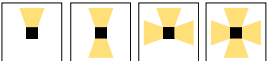



FUNCTIONALITY

-  swivel-mounted + rotatable and swivel-mounted + rotatable
-  radiation direction









SURFACE

-  NANO coating IP XX [see product description]
lotus effect: Water rolls off and takes all dirty surface particles with it.
-  surface paintable / individual design

CONTROL

-  movement sensor (IR / HF)
-  DMX control
-  dimmable
-  1 CH
number of channels

SAFETY

-  IP67
IP protection class
-  walkable
-  passable
-  safety lamp control gear
-  components may be installed on fixtures of materials, the fire behavior of which is not always known.
-  max. surface temperature of lamp control gear
-  protection class I
-  protection class II [protective isolation]
-  protection class III [protective low voltage]



LIGHT COLOURS / CHANNELS
Depending on the LED equipment, different colours can be mixed with the luminaire via the individual RGB / RGBW channels.



LIGHT COLOUR SELECTABLE
Luminaires with the designation "CCT Dip" can be changed in light colour via a dip switch on the housing and can thus be used particularly flexibly.



HCL
HCL stands for "Human Centric Lighting" and means the tuning of artificial light indoors to natural daylight and the human biorhythm.



DIM TO WARM
The dim-to-warm function automatically adjusts the light colour when a luminaire is dimmed. The rule is: the lower the luminous intensity, the warmer the light colour.



COLOUR RENDERING INDEX RA
The colour rendering index Ra describes the measure of the correspondence of the perceived light colour between an existing lighting situation and a reference light source. The higher the Ra value, the better/natural the colour rendering.



COLOUR CONSISTENCY SDCM
The SDCM value describes the standard deviation of an LED from the target colour location and is a measure of production-related colour differences between LEDs with identical values. The higher the value, the greater the colour deviation. The maximum valid deviation is 6 SDCM.



UGR
The UGR value indicates how glare-free a luminaire is, thus avoiding disturbing reflections. The lower the UGR value, the more glare-free a luminaire emits its light. Luminaires with a UGR value < 19 are suitable for office environments and workplaces.



POWER SWITCH
Luminaires with an integrated power switch can be switched in wattage and operated in several power levels. The power reduction enables flexible adjustment of the light intensity and is usually carried out via a dip switch on the unit.



TOOL-FREE INSTALLATION
These luminaires are delivered with pre-assembled components and can be mounted without additional tools. This saves time during installation and enables particularly simple and efficient conversion in the event of renovation or refurbishment.



CONTROLLABLE VIA ...
The luminaire can be controlled via one of the following lighting control systems: RF smart [the new control system from DEKO-LIGHT for up to eight light zones], zigbee, DALI, RF [Radio Frequency], Bluetooth, WiFi.



BEG ELIGIBLE
Eligible luminaires under the BEG programme [Federal funding for efficient buildings] have a system luminous efficacy of at least 120 lm/W [140 lm/W for LED strips] and a service life of 50,000 hours at L80 [80 % luminosity].



SUITABLE FOR VDU WORKSTATIONS
These luminaires meet the requirements of DIN standard EN 12464-1 according to the lighting of indoor workplaces. With a luminance value of L65 < 3000 cd/m², the luminaires are standard-compliant for glare-free VDU workstations.



PASSABLE
Drive-on recessed luminaires are generally used outdoors and can withstand particularly high pressure loads from pedestrians, vehicles and other objects. Drive-in luminaires have an IP protection of at least IP67.



FSC CERTIFIED
FSC® [Forest Stewardship Council®] is an international certification system. Luminaires with FSC® certification use only wood from sustainable forestry.



THROUGH-WIRING POSSIBLE
This luminaire enables through-wiring and can be connected in series with other luminaires. The advantage: luminaires with through-wiring require only one power connection, eliminating the need for costly laying of additional cables.



IP PROTECTION
The IP protection class indicates the protection of live parts against the ingress of foreign bodies and contact [first digit] and against water [second digit] with two digits. The following applies: The higher the respective digit, the higher the protection.



IK IMPACT RESISTANCE
The IK value [or IK impact resistance level] indicates how shock and impact resistant a luminaire or certain components of the luminaire are. The following applies: The higher the IK value [IK00 to IK10+], the greater the protection against external mechanical stress.

THE NEW ENERGY EFFICIENCY CLASSES

The new energy efficiency classes A to G are among the most important requirements of the new EU Ecodesign Directive 2021. We explain what the new energy labels mean.

The European Union's Ecodesign Directive was already adopted in 2009 and has been in force since September 2021. This goes hand in hand with a new scale for determining the energy efficiency value: the previous classification from A+++ to E gives way to a new gradation from A to G. The original scale was intended to distinguish particularly energy-friendly lighting solutions, primarily LED-based. The reason: the original scale was intended to distinguish particularly energy-friendly lighting solutions, primarily LED-based. However, due to great technical progress, even the cheapest LED lamps gradually fell into the A classification, which ran counter to the original purpose [consumer benefit].

The new energy efficiency classes are now strictly based on the luminous efficacy of a light source. Thus, only luminaires with 210 lm/W receive the A label; luminaires with less than 85 lm/W fall into class G. Good to know: The EU's new energy labels have been classified with an eye to the future. Thus, the upper classes A and B remain free for the time being so that manufacturers have leeway for further technological advances without the need to adapt the energy label again in the near future.

In addition to the new energy efficiency classes, manufacturers of artificial lighting are subject to numerous other new requirements. With the expansion of our measurement laboratory, we are already taking these requirements into account and verifying compliance with the specified limit values for stroboscopic effects and light flicker for each product concerned.

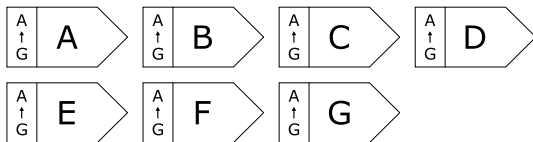
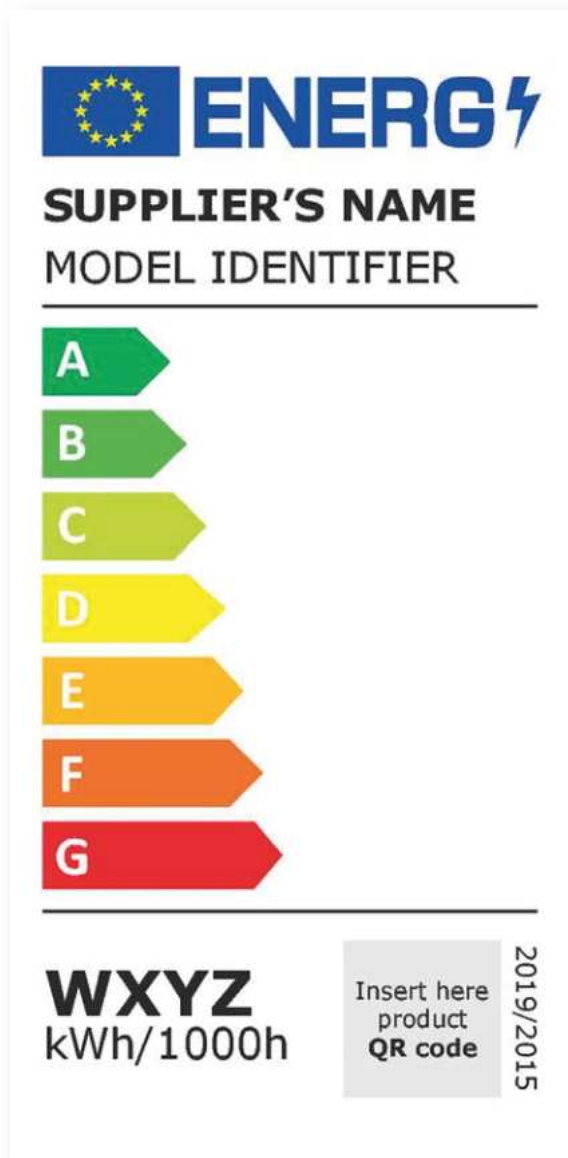

representation in the catalogue

What is the Ecodesign Directive?

The European Union's Ecodesign Directive 2021 includes numerous regulations for various electronics sectors and serves to prevent waste or increase resource efficiency. In this context, the directive regulates the longer and faster availability of spare parts in order to make products more repairable and retrofittable and thus more sustainable. At the same time, a European data room is to be created for the central bundling of product information. Under the keyword "digital product passport", information on materials, spare parts or also on proper disposal is to be summarised in the future and used for all phases along the product life cycle.

further information: ec.europa.eu



ACRUX 68



Using the ACRUX 68 recessed ceiling luminaire as an example, we show the new classification in the new future-proof scale – the product still has the same efficiency! All information on the ACRUX series can be found from page 128.





LIGHT COLOUR SELECTABLE

Luminaires with the designation "CCT Dip" allow you to change the light colour via a small dip switch [usually in the steps 3000K / 4000K / 5000K]. With their high application flexibility, CCT Dip luminaires offer customers who are still unsure about the light colour an enormous decision-making aid - and incidentally reduce your stock requirements.

The colour temperature [light colour] is specified in Kelvin [K] and determines how the respective light is perceived.

WW = warm white light	2.300 K to 3.300 K [high red component]
NW = neutral white light	3.300 K to 5.300 K
CW = cool white / daylight white light	5.300 K to 8.000 K [high blue content]

The following guide values apply as orientation for different rooms following guide values apply:

living and sleeping are	WW
kitchen and bathroom	WW NW
offices	NW
industry	NW CW
photo studio / architectural lighting	CW



COLOUR RENDERING INDEX RA

The colour rendering index Ra is the measure of the correspondence of the perceived light colour between an existing lighting situation and a reference light source. The smaller the deviation, the better the colour rendition. A light source with Ra 100 reproduces all colours exactly. The lower the Ra value, the less precisely the colours are reproduced.

Standard values:	
Incandescent bulb, halogen lamps	up to Ra 100
LED lamps	Ra 75-95
Compact fluorescent and energy-saving lamps	Ra 80-89
Fluorescent lamps	Ra 70-85



RA 70-80 medium colour rendition



RA 80-90 good colour rendition



RA 90-100 very good colour rendition



HCL

HCL stands for "Human Centric Lighting" and means the simulation of lighting situations according to the biological day-night rhythm of humans. HCL matches artificial light indoors to natural daylight and promotes well-being, mood and health. Numerous DEKO-LIGHT luminaires can already be integrated into an HCL control system to adjust the light colours to the biorhythm. In addition, several LED stripes in different light colours can be combined in one profile and thus integrated into the HCL lighting design.

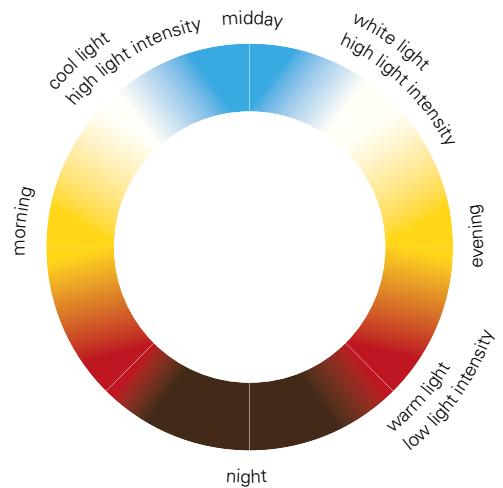

UGR VALUE

The smaller the UGR value, the more glare-free a luminaire emits its light. Especially in office areas, luminaires with a UGR value of less than 19 should be used to avoid disturbing reflections. When determining the UGR value of a complete room, additional factors such as wall colour[s] and surface finishes play a role.



DIM TO WARM

With the dim-to-warm function, you not only adjust the luminous intensity downwards, but by simultaneously changing the light colour [e.g. from 3000 to 2000 K], you obtain a room mood adapted to the new situation. LED luminaires with dim-to-warm technology can therefore be used particularly flexibly.

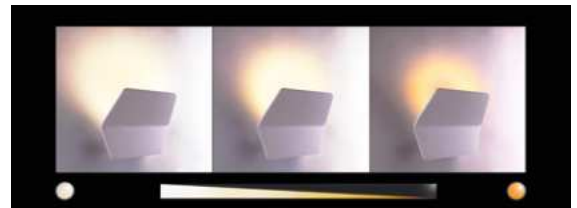

DALI DIMMABLE

Luminaires that can be dimmed via DALI can be perfectly integrated into lighting/property management systems. The great advantage lies in the wiring: via DALI, all luminaires in a line can be individually addressed and controlled. But this variant is also suitable for individual luminaires: DALI dimmers without an address exist for this purpose, which address the power supply unit directly. The good news: most systems on the market already have DALI interfaces.

WHAT IS HOW BRIGHT?

How many lumens do different lamps shine with?

candle	~ 12 lm
100W incandescent bulb	~ 1.340 lm
40W fluorescent lamp	~ 3.000 lm

HOW MANY LUMENS CORRESPOND

HOW MANY WATT?

Luminous efficacy is measured in lumens per watt [lm/W] and indicates how efficiently a lamp shines and how energy is converted into light.

guide values:

incandescent bulb	approx 10 lm/W
halogen lamp	approx 20 lm/W
fluorescent lamp	approx 70-90 lm/W
LED lamp	approx 60-170 lm/W

WHERE DO I NEED HOW MANY LUMENS?

You should plan for these lumens per square metre, so that your home is optimally and comfortably illuminated:

guide values:

living room	approx 140 lm/m ²
bedroom	approx 140 lm/m ²
children's room	approx 140 lm/m ²
hallway	approx 140 lm/m ²
study	approx 280 lm/m ²
kitchen	approx 280 lm/m ²
bathroom	approx 280 lm/m ²

WHAT DOES »LUX« MEAN?

Lux [lx] is the physical unit of the illuminance of a light source. This photometric quantity indicates how much luminous flux from a light source falls on a given surface.

Of course, the following values do not have to be achieved in the entire room.

guide values:

bedroom	45 Lux
living room	77 Lux
bathroom	110 Lux
hallway	207 Lux
study/office	300 Lux [at desk: 500 Lux]



IK VALUE

In addition to the IP protection class, you should also keep an eye on the IK value of a luminaire, which is increasingly required within the scope of tenders and for installations in public spaces. The IK value [or IK impact resistance level] indicates how impact-resistant a luminaire or certain components are. IK00 offers no protection against external mechanical stress, IK10 or IK10+ means that the luminaire can withstand a 5 or 10 kg test weight from a distance of 40 or 50 cm.

There are eleven codes, corresponding to the impact energy that a enclosure can withstand. [source: wikipedia.org]

Code	impact energy in joules	corresponds to drop height in mass	
IK00	no protection		
IK01	0,14	7 cm	- 200 g
IK02	0,20	8 cm	- 250 g
IK03	0,35	14 cm	- 250 g
IK04	0,50	20 cm	- 250 g
IK05	0,70	28 cm	- 250 g
IK06	1,0	40 cm	- 250 g
IK07	2,0	40 cm	- 500 g
IK08	5,0	25 cm	- 2000 g
IK09	10,0	20 cm	- 5000 g
IK10	20,0	40 cm	- 5000 g
IK10+	50,0	50 cm	- 10000 g

WHAT IS THE »AVERAGE RATED LIFE« OF AN LED?

The average rated service life of LEDs covers the period from the first time they are switched on until the time when only 50 percent of the LEDs tested are still functioning properly.

A specified service life of 30,000 hours for an LED stripe therefore means that after this period, on average, half of all stripes will have failed.

WHAT DOES »BINNING« MEAN?

Binning guarantees a constant quality of light with the same brightness level and uniform light colour. For this purpose the LEDs of a production batch are sorted and divided into so-called »bins«.

NORM TABLE

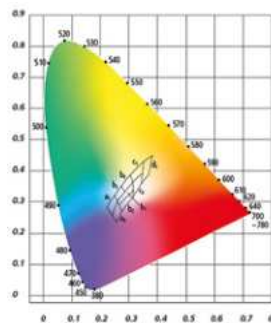

BINNINGS

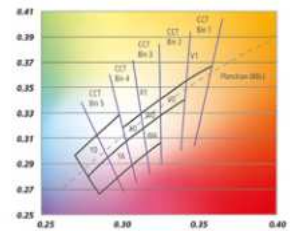

WHITE LEDs

With the kind support of Licht von Klein / licht-von-klein.de



IP PROTECTION ZONES

ZONE 3 | IP23

Outside zones 0 to 2, no special IP protection is necessary, provided no cleaning with direct water irradiation takes place.

ZONE 2 | IP44

In the areas 60 cm from zone 1, IP X4 protection applies.

ZONE 1 | IP65

In the wall area of the shower as well as in the tile area exposed to IP X5 is specified for the wall area of the shower and in the tile area exposed to splash water [max. 50 V].

ZONE 0 | IP67

In bathtubs and shower trays, low-voltage [max. 12 V] is absolutely required. The minimum IP protection is IP X7 [protected against water penetration].

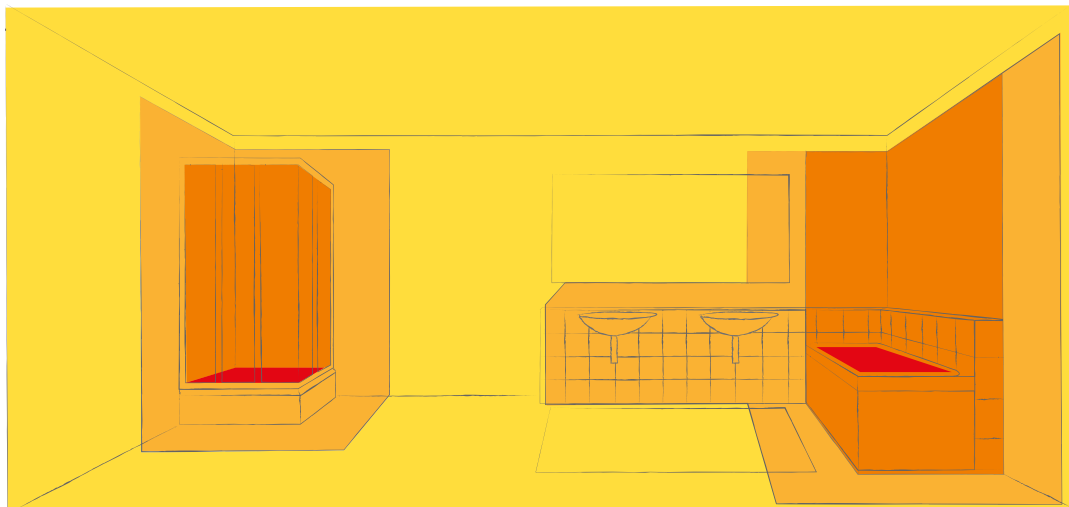
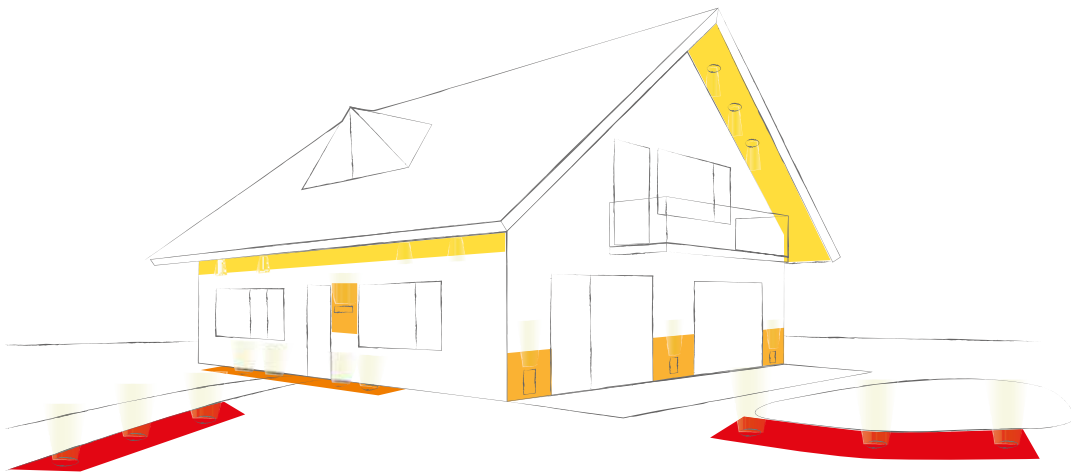

PROTECTION TYPES AND INSULATION CLASSES

Luminaires and other electrical appliances have a housing that protects live parts from contact, moisture or other environmental influences. This protection depends on the respective area of application. In order to have an overview of the suitable application, all devices are assigned to a classified protection type and an insulation class.

IP67

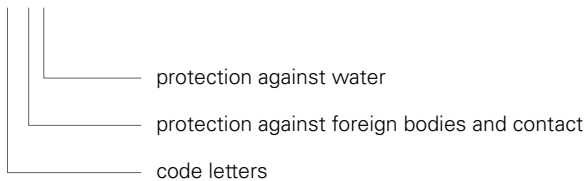

1. digit	protection against foreign bodies and contact	2. digit	protection against water
0	no protection	0	no protection
1	large foreign bodies [Ø > 50 mm] large body parts [e.g. back of the hand]	1	protection against vertically falling dripping water
2	medium-sized foreign bodies [Ø > 12 mm] finger	2	protection against dripping water falling at an angle [up to 15°]
3	small foreign bodies [Ø > 2,5 mm] tools and wires [Ø > 2,5 mm]	3	protection against water spray up to 60° from vertical
4	granular foreign bodies [Ø > 1 mm] tools and wires [Ø > 1 mm]	4	protection against splashing water on all sides
5	dust deposit complete protection against accidental contact	5	protection against jet water
6	dust entry complete protection against accidental contact	6	protection against jet water
		7	protection against temporary immersion
		8	protection against permanent immersion

**AT HOME EVERYWHERE – OUR LIGHTING SOLUTIONS
ARE AT HOME IN EVERY APPLICATION.
LET YOURSELF BE INSPIRED BY SELECTED PROJECT REFERENCES
FROM A WIDE VARIETY OF AREAS.**

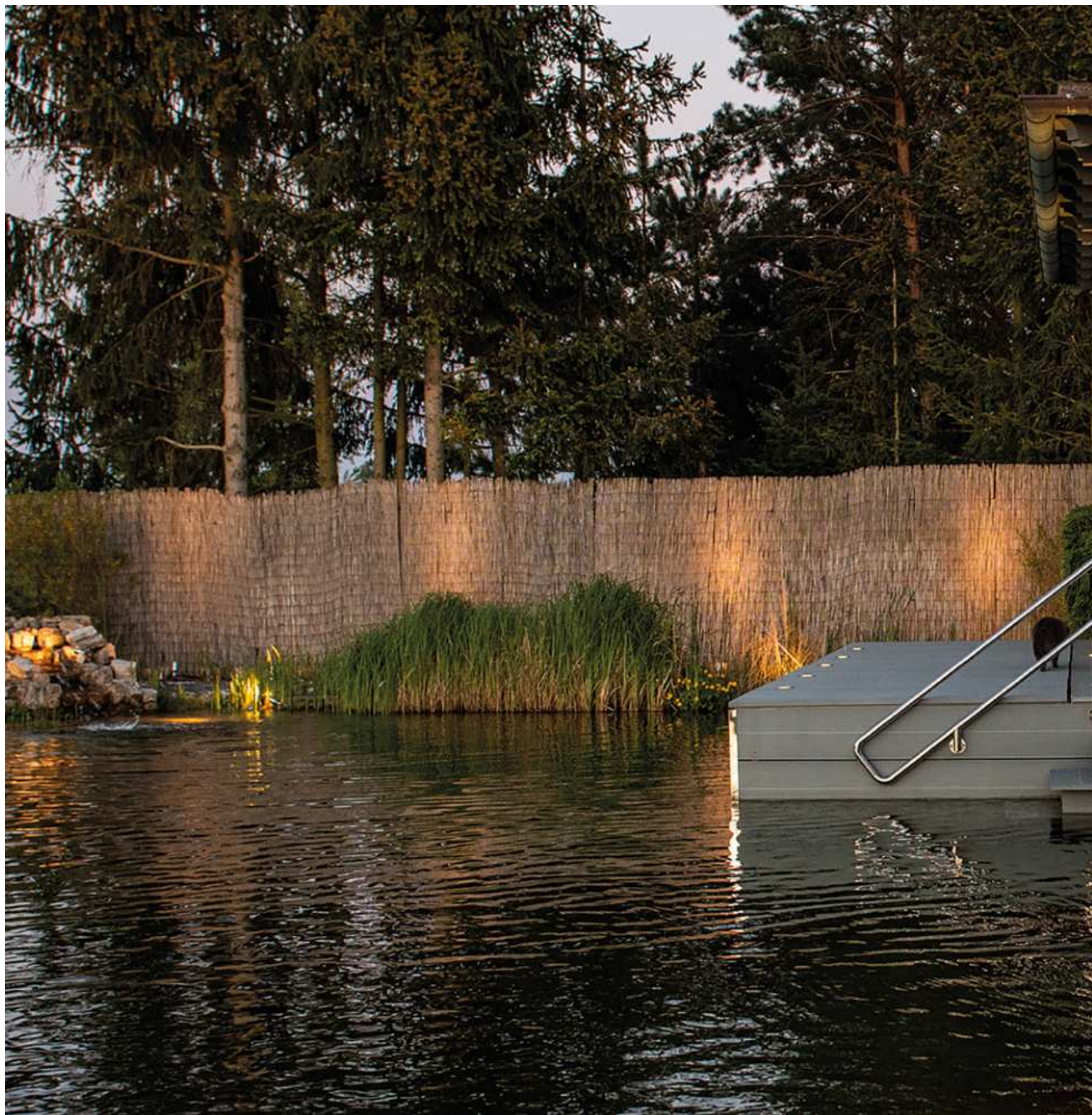

With the kind support of Licht und Klein, Bergisch Gladbach

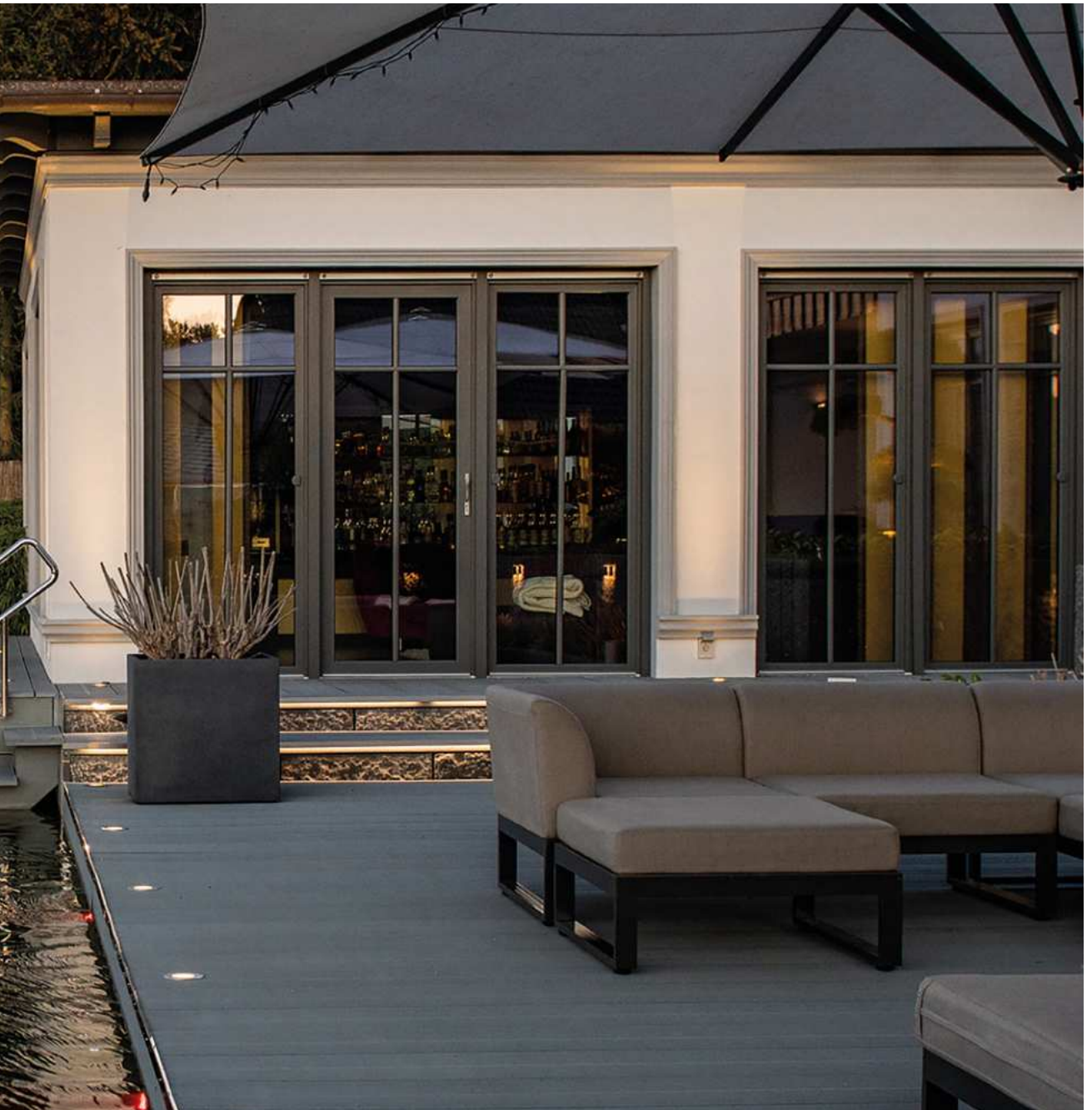

EXTERIOR

Whether free-standing luminaires, surface-mounted luminaires, underwater luminaires, recessed wall luminaires or wall washers - the outdoor area of a property, store or hotel should leave a lasting impression on visitors. Our example project shows a private house with an extensive outdoor area, which was staged with a great sense of noble elegance and lots of outdoor luminaires.



LIVING ROOM

Atmospheric light in living spaces is indispensable to create a harmonious ambience. With our extensive product portfolio, we cover everything from pendant luminaires to ceiling and furniture recessed luminaires to wall luminaires that you need to perfectly stage your four walls. Refine your premises with recessed wall luminaires and set professional lighting accents to create a cosy atmosphere for your living space.





LINEAR LIGHT

In order to emphasize and highlight design elements in architecture or even to deliberately arouse emotions through the interplay of light and shadow, linear light is increasingly becoming the focus of attention. The office building of an architectural firm is impressive proof of this. A modern, open building – stylishly illuminated with linear lighting solutions from DEKO-LIGHT.





Foto: Daniel Vieser . Architektur fotografie, Karlsruhe



Foto: Daniel Vieser . Architektur fotografie, Karlsruhe



With the kind support of SH-Lichttechnik / Becks Reutlingen



HOTEL AND GASTRONOMY

Bars, restaurants and hotels only become a cozy place where guests like to come again and again with the right lighting. For this reason, the versatile lighting and profile portfolio of DEKO-LIGHT was used for the lighting design of the extensive restaurant areas.



STORE AND TRADE FAIR CONSTRUCTION

An individual and well thought-out lighting design not only enhances the visual value of a retail environment, but also has a sales-promoting effect. Flexibility is the key here, because the layout and displays of a store can change again and again. With our D LINE track systems and matching store fitting and display luminaires, you are ideally equipped to set the lighting stage for your sales areas.

With the kind support of WIBU-SYSTEMS AG, Karlsruhe



OFFICE AND BUSINESS PREMISES

A pleasant atmosphere at work not only boosts the mood of employees, but also their motivation and productivity. For an ultra-modern new company building in Karlsruhe, only luminaires and lighting technology from DEKO-LIGHT are used in an area of over 16,000 m² – from recessed ceiling luminaires in the corridors to custom solutions in the foyer area.

With the kind support of WIBU-SYSTEMS AG, Karlsruhe







COMMERCIAL

Commercial spaces are highly functional and place the highest demands on lighting efficiency. In our example project, the hall lighting for a BOSCH car service provider was implemented with TriProof LED surface-mounted ceiling luminaires, which with their IP65 protection class are convincing even in the adjacent car wash.

Hersteller / manufacturer: DEKO-LIGHT Elektronik Vertriebs GmbH

Distributor pro ČR a SR:

AULIX
WE LIVE FOR LIGHTING

www.aulix.cz