

NOVEMBER 2024



light is life



*At Kohl Lighting we know that light is the best companion for the spaces you design. That is why we are introducing a collection with "Light is life" motto; because light is life and makes your projects stand out.*

En Kohl Lighting sabemos que la luz es la mejor compañera de los espacios que diseñas. Por ello te presentamos una colección que despunta con el lema "Light is life"; porque la luz es vida y da vida a tus proyectos.



INDOOR

SURFACE

RECESSED WITH FRAME  
LED | GU



n ses  
K51300  
pag.18



chas  
K51400  
pag.29



disc detek  
k-select  
sensor  
K53280  
pag.21



disc slim  
K51700  
pag.22



disc  
slim sq  
K51701  
pag.24



disc mini  
rocco  
K51706  
pag.26



eryl  
K51000  
pag.30



luxo  
aura  
K50155  
pag.31



luxo  
lur  
K50154  
pag.34



moon  
totem  
K50133  
pag.35



n ses  
tilt  
K51301  
pag.41



n ses  
K51300  
pag.42



luxo tilt  
K50151  
pag.52



luxo IP65  
K50153  
pag.55



versus  
K51100  
pag.45



versus  
litl  
K51103  
pag.47



versus  
muzzy  
K51101  
pag.48



versus  
muzzy sq  
K51102  
pag.50



noon sq  
K50805  
pag.64



noon sq  
asymmetric  
K50806  
pag.65



lim  
miranda sq  
K53105  
pag.75



disc  
K51702  
pag.76



rebecca  
K53270  
pag.66



lim  
K50320  
pag.69



lim sq  
K50321  
pag.70



lim lacus  
K53300  
pag.72



chess  
k-select  
K50510  
pag.91



chess de  
k-select  
K50515  
pag.93



disc  
slim  
K51704  
pag.82



disc  
slim sq  
K51705  
pag.83



disc  
mini tiny  
K50600  
pag.84



disc mini  
tiny sq  
K50601  
pag.85



sun  
dawn  
K50141  
pag.105



venus  
K50111  
pag.106



chess  
elite  
k-select  
K50523  
pag.95



chess  
winner  
k-select  
K50522  
pag.97



moon  
K50110  
pag.100



moon  
daisy  
K50132  
pag.101



ozone  
K50112  
pag.103



sun  
K50140  
pag.104



moon  
K50110  
pag.100

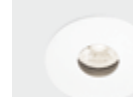

venus  
dot  
K50130  
pag.109

	<p>WALL SURFACE</p>		<p><b>marvin</b> K50707 pag.112</p>		<p><b>kubiq</b> K50708 pag.114</p>
	<p>TRIMLESS LED   GU</p>		<p><b>nseS</b> K51300 pag.134</p>		<p><b>ozone sat sq</b> K50125 pag.139</p>
		<p><b>agatar</b> K51201 pag.150</p>		<p>TRACK LIGHT</p>	
<p>OUTDOOR</p>		<p>SURFACE</p>		<p><b>besel</b> K60010 pag.171</p>	

	<p><b>serena</b> K50709 pag.117</p>		<p><b>sasha</b> K50710 pag.118</p>		<p><b>meso</b> K50706 pag.121</p>		<p><b>wally</b> K50700 pag.131</p>
<p>WALL RECESSED</p>		<p><b>turma</b> K51207 pag.142</p>		<p><b>kora</b> K51206 pag.143</p>		<p><b>rubix</b> K51205 pag.144</p>	
	<p><b>nseS</b> K51300 pag.157</p>		<p><b>sign</b> K50702 pag.145</p>		<p><b>jadex</b> K51203 pag.146</p>		<p><b>chas</b> K51400 pag.165</p>
	<p>WALL SURFACE</p>		<p><b>cap</b> K60002 pag.176</p>		<p><b>pat</b> K60003 pag.179</p>		<p><b>tuile</b> K60005 pag.177</p>
	<p><b>tap</b> K60004 pag.180</p>						

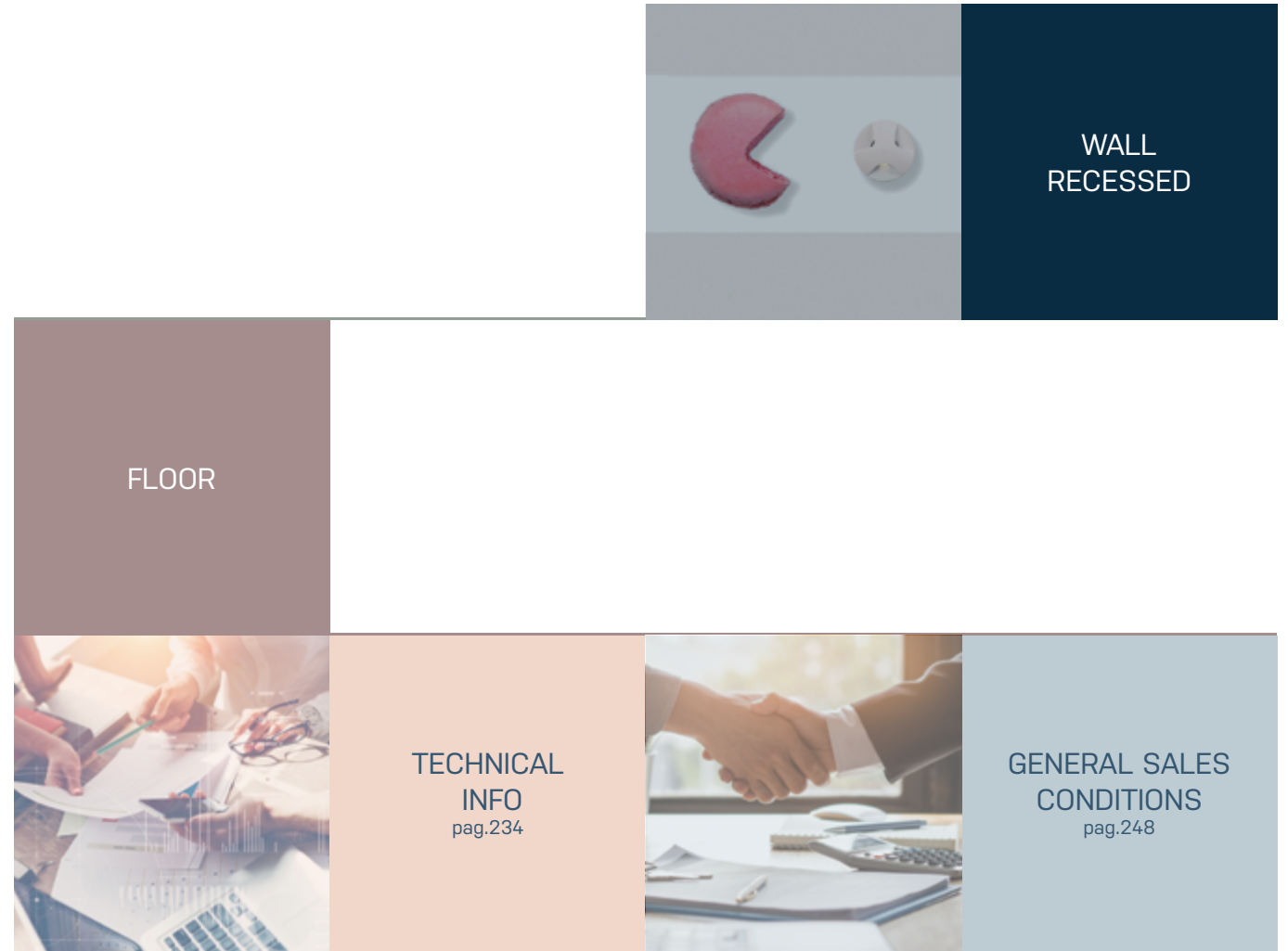
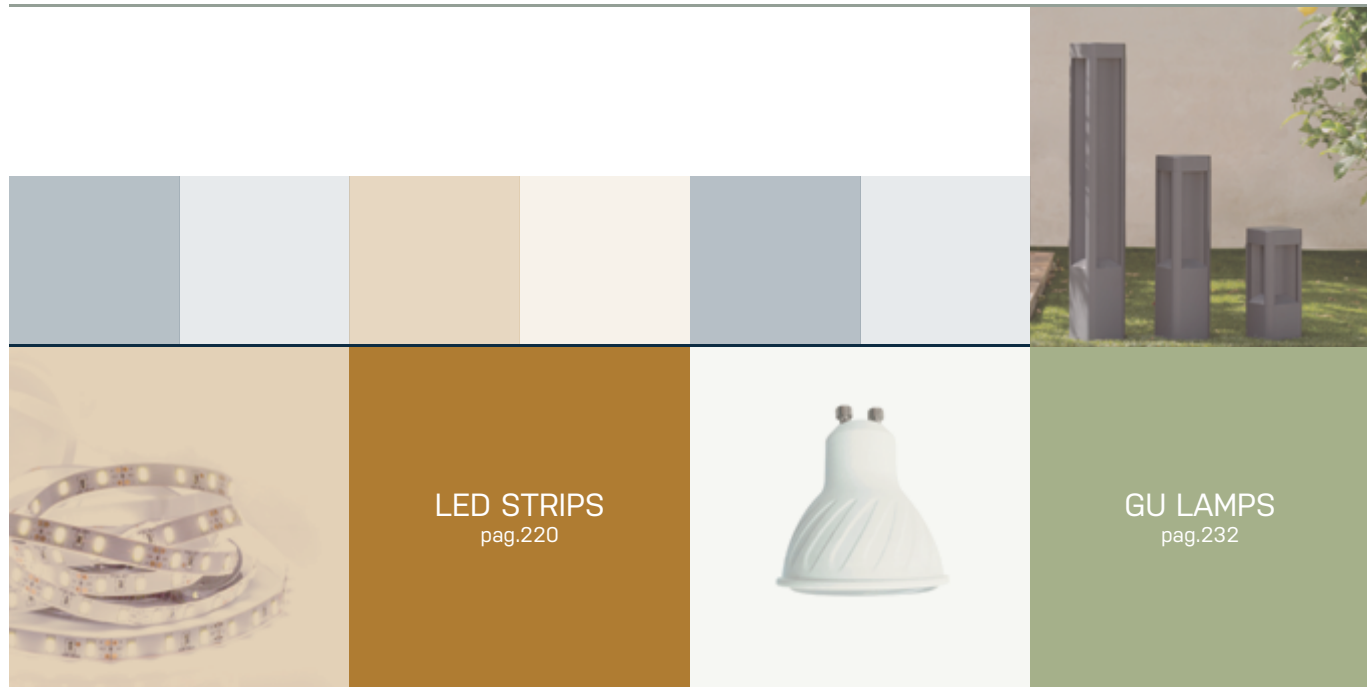

light is life







indoor





SURFACE



nse  
K51300

- ALUMINIUM
- IP20
- IK08
- LIGHT DIRECTION FIXED
- NON DIMMABLE
- INTEGRATED
- 0°
- 0°
- INDOOR
- 220-240 V 50-60 Hz
- LIFE 50.000h
- WARRANTY 5 Years
- CE

Other installations / Otras instalaciones.

- pag. 42 .RF
- pag. 134 .TR
- pag. 157 .TK

NSES	ref.	dimensions mm.	inst.	finish	optic options	power	CRI	K	eff. Lm/W	lumen max.	dimmm opt.	tech opt.	watt max.	mA	sketch	
	K51300	.01 137x35x80	.SR	●	■	.ST	.9	90	.27	70	835	▲	◆	10	700	
									.30	73	875					
									.40	76	915					
								● ext-int finish .BK-BK   .WH-BK		■ .15   .30   .45						

NSES	ref.	dimensions mm.	inst.	finish	optic options	power	CRI	K	eff. Lm/W	lumen max.	dimmm opt.	tech opt.	watt max.	mA	sketch	
	K51300	.02 270x35x80	.SR	●	■	.ST	.9	90	.27	68	1430	▲	◆	20	600	
									.30	73	1530					
									.40	78	1630					
								● ext-int finish .BK-BK   .WH-BK		■ .15   .30   .45						





# disc detek k-select sensor

- ALUMINIUM
- IP20
- IK05
- LIGHT DIRECTION FIXED
- NON DIMMABLE
- 220-240 V 50-60 Hz
- INDOOR
- WARRANTY 5 Years
- CE
- SR

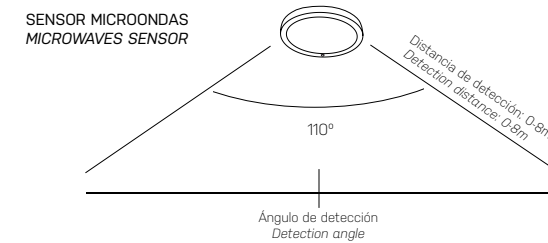

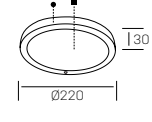
DISC DETEK K-SELECT SENSOR	ref.	dimensions mm.	inst.	finish	optic options	power	CRI	K <sup>1</sup>	eff. Lm/W	lumen max.	dim. opt.	tech opt.	watt max.	mA	sketch
	<b>K53280</b>	<b>.01</b> Ø220x30	<b>.SR</b>	●	■	<b>.ST</b>	<b>.8</b>	80	<b>.30</b>	87	1470	▲	◆	18	
									<b>.40</b>	94	1600				
									<b>.60</b>	93	1580				
				● ext-int finish <b>.WH-WH</b>	■ <b>.OP</b>	▲	◆	<b>K53280.01.SR.XX.OP.ST.8.01</b>							

\*1 The luminaire includes three color temperatures (3000K-4000K-6000K), manually selectable before its installation by switch. / La luminaria incluye las tres temperaturas de color (3000K-4000K-6000K), seleccionables de forma manual antes de su instalación mediante switch.  
 \*2 Kselect model is indicated by .01 in the nomenclature. / El modelo kselect, se indica con .01 en la nomenclatura.

indoor  
SR

# disc slim

K51700

indoor

SR



Other installations / Otras instalaciones.

pag. 82

DISC SLIM	ref.	dimensions mm.	inst.	finish	optic options	power	CRI	K	eff. Lm/W	lumen max.	dimm opt.	tech opt.	watt max.	mA	sketch	
	K51700	.01 Ø90x35	.SR	●	■	.ST	.8	80	.27	66	410	▲	◆	6	160	
									.30	69	430					
									.40	72	450					
				● ext-int finish .BK-BK   .WH-WH		■ .OP	▲*1 .DA   .PU   .D1   .PC		◆		● ■ ▲ K51700.01.SR.XX.OP.ST.8.XX.XX					

DISC SLIM	ref.	dimensions mm.	inst.	finish	optic options	power	CRI	K	eff. Lm/W	lumen max.	dimm opt.	tech opt.	watt max.	mA	sketch	
	K51700	.02 Ø145x35	.SR	●	■	.ST	.8	80	.27	96	1150	▲	◆	12	300	
									.30	94	1170					
									.40	95	1190					
				● ext-int finish .BK-BK   .WH-WH		■ .OP	▲*1 .DA   .PU   .D1   .PC		◆		● ■ ▲ K51700.02.SR.XX.OP.ST.8.XX.XX					

DISC SLIM	ref.	dimensions mm.	inst.	finish	optic options	power	CRI	K	eff. Lm/W	lumen max.	dimm opt.	tech opt.	watt max.	mA	sketch	
	K51700	.03 Ø225x35	.SR	●	■	.ST	.8	80	.27	96	2300	▲	◆	24	600	
									.30	98	2350					
									.40	100	2400					
				● ext-int finish .BK-BK   .WH-WH		■ .OP	▲*1 .DA   .PU   .D1   .PC		◆		● ■ ▲ K51700.03.SR.XX.OP.ST.8.XX.XX					

\*1 Dimmable driver for models .01, .02, .03 needs to be remote. / El driver dimable para los modelos .01, .02, .03 va en remoto.

DISC SLIM	ref.	dimensions mm.	inst.	finish	optic options	power	CRI	K	eff. Lm/W	lumen max.	dimm opt.	tech opt.	watt max.	mA	sketch	
	K51700	.04 Ø300x40	.SR	●	■	.ST	.8	80	.27	96	2300	▲	◆	24	600	
									.30	98	2350					
									.40	100	2400					
				● ext-int finish .BK-BK   .WH-WH		■ .OP	▲ .DA   .PU   .D1   .PC *2		◆		● ■ ▲ K51700.04.SR.XX.OP.ST.8.XX.XX					

DISC SLIM	ref.	dimensions mm.	inst.	finish	optic options	power	CRI	K	eff. Lm/W	lumen max.	dimm opt.	tech opt.	watt max.	mA	sketch	
	K51700	.05 Ø400x40	.SR	●	■	.ST	.8	80	.27	90	3400	▲	◆	38	900	
									.30	97	3450					
									.40	98	3500					
				● ext-int finish .BK-BK   .WH-WH		■ .OP	▲ .DA   .PU   .D1		◆		● ■ ▲ K51700.05.SR.XX.OP.ST.8.XX.XX					

DISC SLIM	ref.	dimensions mm.	inst.	finish	optic options	power	CRI	K	eff. Lm/W	lumen max.	dimm opt.	tech opt.	watt max.	mA	sketch	
	K51700	.06 Ø500x40	.SR	●	■	.ST	.8	80	.27	87	4150	▲	◆	48	1200	
									.30	89	4200					
									.40	90	4250					
				● ext-int finish .BK-BK   .WH-WH		■ .OP	▲ .DA   .PU   .D1   .PC *2		◆		● ■ ▲ K51700.06.SR.XX.OP.ST.8.XX.XX					

DISC SLIM	ref.	dimensions mm.	inst.	finish	optic options	power	CRI	K	eff. Lm/W	lumen max.	dimm opt.	tech opt.	watt max.	mA	sketch	
	K51700	.07 Ø600x40	.SR	●	■	.ST	.8	80	.27	86	4800	▲	◆	56	1400	
									.30	87	4850					
									.40	88	4900					
				● ext-int finish .BK-BK   .WH-WH		■ .OP	▲ .DA   .PU   .D1		◆		● ■ ▲ K51700.07.SR.XX.OP.ST.8.XX.XX					

\*2 Dimmable PC driver for models .04 and .06 needs to be remote. / El driver dimable PC para los modelos .04 y .06 va en remoto.

# disc slim sq

K51701

indoor

SR



Other installations / Otras instalaciones.

pag. 83 .RF



DISC SLIM SQ	ref.	dimensions mm.	inst.	finish	optic options	power	CRI	K	eff. Lm/W	lumen max.	dimm opt.	tech opt.	watt max.	mA	sketch	
	K51701	.01 90x90x35	.SR	●	■	.ST	.8	80	.30	69	430	▲	◆	6	160	
										.40	72					
				● ext-int finish .BK-BK   .WH-WH		■ .OP		▲*1 .DA   .PU   .D1   .PC		K51701.01.SR.XX.OP.SR.8.XX.XX						

DISC SLIM SQ	ref.	dimensions mm.	inst.	finish	optic options	power	CRI	K	eff. Lm/W	lumen max.	dimm opt.	tech opt.	watt max.	mA	sketch	
	K51701	.02 145x145x35	.SR	●	■	.ST	.8	80	.30	94	1170	▲	◆	12	300	
										.40	95					
				● ext-int finish .BK-BK   .WH-WH		■ .OP		▲*1 .DA   .PU   .D1   .PC		K51701.02.SR.XX.OP.SR.8.XX.XX						

\*1 All dimmable drivers for models .01, .02, .03 and .PC dimmable .04 needs to be remote. / Los drivers dimables para los modelos .01, .02, .03 y driver dimable .PC.04 va en remoto.



▲ K51701 disc slim sq

▲ K55006 flow

DISC SLIM SQ	ref.	dimensions mm.	inst.	finish	optic options	power	CRI	K	eff. Lm/W	lumen max.	dimm opt.	tech opt.	watt max.	mA	sketch	
	K51701	.03 225x225x35	.SR	●	■	.ST	.8	80	.30	99	2350	▲	◆	24	600	
										.40	100					
				● ext-int finish .BK-BK   .WH-WH		■ .OP		▲*1 .DA   .PU   .D1   .PC		K51701.03.SR.XX.OP.SR.8.XX.XX						

DISC SLIM SQ	ref.	dimensions mm.	inst.	finish	optic options	power	CRI	K	eff. Lm/W	lumen max.	dimm opt.	tech opt.	watt max.	mA	sketch	
	K51701	.04 300x300x40	.SR	●	■	.ST	.8	80	.30	99	2350	▲	◆	24	600	
										.40	100					
				● ext-int finish .BK-BK   .WH-WH		■ .OP		▲*1 .DA   .PU   .D1   .PC		K51701.04.SR.XX.OP.SR.8.XX.XX						

DISC SLIM SQ	ref.	dimensions mm.	inst.	finish	optic options	power	CRI	K	eff. Lm/W	lumen max.	dimm opt.	tech opt.	watt max.	mA	sketch	
	K51701	.05 400x400x40	.SR	●	■	.ST	.8	80	.30	97	3450	▲	◆	36	900	
										.40	98					
				● ext-int finish .BK-BK   .WH-WH		■ .OP		▲*1 .DA   .PU   .D1		K51701.05.SR.XX.OP.SR.8.XX.XX						

\*1 All dimmable drivers for models .01, .02, .03 and .PC dimmable .04 needs to be remote. / Los drivers dimables para los modelos .01, .02, .03 y driver dimable .PC.04 va en remoto.

indoor  
SR



# disc mini rocco

K51706

- ALUMINIUM
- IP20
- IK02
- LIGHT DIRECTION FIXED
- NON DIMMABLE
- INTEGRATED
- 0°
- 0°
- INDOOR
- 220-240 V 50-60 Hz
- LIFE 50.000h
- WARRANTY 5 Years
- CE
- RoHS

DISC MINI ROCCO	ref.	dimensions mm.	inst.	finish	optic options	power	CRI	K	eff. Lm/W	lumen max.	dimmm opt.	tech opt.	watt max.	mA	sketch	
	K51706	.01 Ø90x65	.SR	●	■	.ST	.8	80	.30	90	760	▲	◆	8	300	
									.40	100	845					
				● ext-int finish .BK-BK   .WH-WH		■ .OP		▲		◆		K51706.01.SR.XX.OP.ST.8.XX				

DISC MINI ROCCO	ref.	dimensions mm.	inst.	finish	optic options	power	CRI	K	eff. Lm/W	lumen max.	dimmm opt.	tech opt.	watt max.	mA	sketch	
	K51706	.02 Ø120x65	.SR	●	■	.ST	.8	80	.30	100	1250	▲	◆	12	300	
									.40	110	1380					
				● ext-int finish .BK-BK   .WH-WH		■ .OP		▲		◆		K51706.02.SR.XX.OP.ST.8.XX				

DISC MINI ROCCO	ref.	dimensions mm.	inst.	finish	optic options	power	CRI	K	eff. Lm/W	lumen max.	dimmm opt.	tech opt.	watt max.	mA	sketch	
	K51706	.03 Ø140x65	.SR	●	■	.ST	.8	80	.30	97	1600	▲	◆	16	350	
									.40	110	1815					
				● ext-int finish .BK-BK   .WH-WH		■ .OP		▲		◆		K51706.03.SR.XX.OP.ST.8.XX				



▲





chas  
K51400

indoor  
SR

- PC
- IP20
- IK05
- LIGHT DIRECTION FIXED
- NON DIMMABLE
- INTEGRATED
- 0°
- 0°
- INDOOR
- 220-240 V 50-60 Hz
- LIFE 50.000h
- WARRANTY 5 Years
- CE
- RoHS

Other installations / Otras instalaciones.

pag. 165 PN

CHAS	ref.	dimensions mm.	inst.	finish	optic options	power	CRI	K	eff. Lm/W	lumen max.	dimmm opt.	tech opt.	watt max.	mA	sketch
	<b>K51400</b>	<b>.01</b> Ø460x150	<b>.SR</b>	●	■	<b>.ST</b>	<b>.8</b> 80	<b>.30</b>	100	3000	▲	◆	30	300	
				● ext-int finish <b>.BK-WH   .GY-WH   .WH-WH</b>			<b>.OP</b>		▲		◆		<b>K51400.01.SR.XX.OP.ST.8.30</b>		



indoor  
SR



# eryl

## K51000

- ALUMINIUM
- IP20
- IK06
- LIGHT DIRECTION FIXED
- NON DIMMABLE
- INTEGRATED
- 0°
- 0°
- INDOOR
- 220-240 V 50-60 Hz
- LIFE 50.000h
- WARRANTY 5 Years
- CE
- RoHS

ERYL	ref.	dimensions mm.	inst.	finish	optic options	power	CRI	K	eff. Lm/W*	lumen max.*	dimmm opt.	tech opt.	watt max.	mA	sketch	
	K51000	.01 Ø65x45	.SR	●	■	.ST	.8	80	.30	71	570	▲	◆	8	-	
									.40	74	592					
				● ext-int finish .BK-BK   .WH-WH		■ .36		▲		◆		K51000.01.SR.XX.36.ST.8.XX				

ERYL	ref.	dimensions mm.	inst.	finish	optic options	power	CRI	K	eff. Lm/W*	lumen max.*	dimmm opt.	tech opt.	watt max.	mA	sketch	
	K51000	.02 Ø80x55	.SR	●	■	.ST	.8	80	.30	74	888	▲	◆	12	-	
									.40	77	920					
				● ext-int finish .BK-BK   .WH-WH		■ .36		▲		◆		K51000.02.SR.XX.36.ST.8.XX				

ERYL	ref.	dimensions mm.	inst.	finish	optic options	power	CRI	K	eff. Lm/W*	lumen max.*	dimmm opt.	tech opt.	watt max.	mA	sketch	
	K51000	.03 Ø95x65	.SR	●	■	.ST	.8	80	.30	72	1430	▲	◆	20	-	
									.40	76	1520					
				● ext-int finish .BK-BK   .WH-WH		■ .36		▲		◆		K51000.03.SR.XX.36.ST.8.XX				

\* Please might expect a max. 15% value reduction in finishes other than white. / Puede haber una reducción máx. del 15% en el dato de los acabados distintos al blanco.



# luxo aura

## K50155

- ALUMINIUM
- IP20
- IK06
- LIGHT DIRECTION ADJUSTABLE
- DIM OPTIONAL
- INTEGRATED
- 360°
- 355°
- INDOOR
- 220-240 V 50-60 Hz
- LIFE 50.000h
- WARRANTY 5 Years
- CE
- RoHS

LUXO AURA	ref.	dimensions mm.	inst.	finish	optic options	power	CRI	K	eff. Lm/W* <sup>1</sup>	lumen max.* <sup>1</sup>	dimmm opt.	tech opt.	watt max.	mA	sketch	
	K50155	.01 94x45x90	.SR	●	■	.ST	.9	90	.30	83	580	▲	◆	7	200	
									.40	96	670					
				● ext-int finish .BK-BK   .WH-WH		■ .38		▲ <sup>2</sup>		◆		K50155.01.SR.XX.38.ST.9.XX.XX				

\*<sup>1</sup> Please might expect a max. 15% value reduction in finishes other than white. / Puede haber una reducción máx. del 15% en el dato de los acabados distintos al blanco.

\*<sup>2</sup> Dimmable driver for luminaire needs to be remote. / El driver dimable para la luminaria va en remoto.

indoor  
SR



indoor

SR



luxo lur

K50154



moon totem

K50133



indoor

SR



GU Lamps / Lámparas GU.

pag. 233 **GU**

LUXO LUR	ref.	dimensions mm.	inst.	finish	optic options	power	CRI	K	eff. Lm/W	lumen max.	dimm opt.	tech opt.	watt max.	mA	sketch	
	K50154	.01 Ø78x102	.SR	●	■	.ST	.9	90	.30	72	722	▲	◆	10	300	
									.40	78	783					
				● ext-int finish .BK-SB   .WH-SB	■	.38	▲*1 .DA   .PU   .D1   .PC	◆	● ■ ▲ K50154.01.SR.XX.38.ST.9.XX.XX							

\*1 Dimmable driver for luminaire needs to be remote. / El driver dimable para la luminaria va en remoto.

MOON TOTEM	ref.	dimensions mm.	inst.	finish	optic options	power	CRI	K	eff. Lm/W	lumen max.	dimm opt.	tech opt.	watt max.	mA	sketch
	K50133	.01 Ø80x117	.SR	●	■	-	-	-	-	-	▲	◆	8W LED	-	
								-	-	-					
								-	-	-					
				● ext-int finish .WH-WH   .BK-BK	■	.GU	▲	◆	● ■ ▲ K50133.01.SR.XX.GU						



RECESSED  
WITH FRAME





# nse tilt

K51301

- ALUMINIUM
- IP20 / IP23
- IK08
- LIGHT DIRECTION ADJUSTABLE
- DIM OPTIONAL
- REMOTE
- 15°
- 0°
- INDOOR
- 220-240 V 50-60 Hz
- LIFE 50,000h
- WARRANTY 5 Years
- CE
- RF

NSES TILT	ref.	dimensions mm.	inst.	finish	optic options	power	CRI	K	eff. Lm/W	lumen max.	dimmm opt.	tech opt.	watt max.	mA	sketch	
	K51301	.01 123x58x48.5	.RF	●	■	.ST	.9	90	.27	69	480	▲	◆	6	700	
									.30	74	520					
									.40	80	560					
		● ext-int finish .BK-BK-BK   .WH-BK-BK		.15   .30   .45		▲ .DA   .PU		● ■ ▲ K51301.01.RF.XX.XX.ST.9.XX.XX								

NSES TILT	ref.	dimensions mm.	inst.	finish	optic options	power	CRI	K	eff. Lm/W	lumen max.	dimmm opt.	tech opt.	watt max.	mA	sketch	
	K51301	.02 167x58x48.5	.RF	●	■	.ST	.9	90	.27	70	835	▲	◆	10	700	
									.30	73	875					
									.40	76	915					
		● ext-int finish .BK-BK-BK   .WH-BK-BK		.15   .30   .45		▲ .DA   .PU   .D1		● ■ ▲ K51301.02.RF.XX.XX.ST.9.XX.XX								

NSES TILT	ref.	dimensions mm.	inst.	finish	optic options	power	CRI	K	eff. Lm/W	lumen max.	dimmm opt.	tech opt.	watt max.	mA	sketch	
	K51301	.03 300x58x48.5	.RF	●	■	.ST	.9	90	.27	68	1430	▲	◆	20	600	
									.30	73	1530					
									.40	78	1630					
		● ext-int finish .BK-BK-BK   .WH-BK-BK		.15   .30   .45		▲ .DA   .PU   .D1   .PC		● ■ ▲ K51301.03.RF.XX.XX.ST.9.XX.XX								

nseS

K51300

indoor



NSES	ref.	dimensions mm.	inst.	finish	optic options	power	CRI	K	eff. Lm/W	lumen max.	dimm opt.	tech opt.	watt max.	mA	sketch
	K51300	.01 45x45x50	.RF	●	■	.ST	.9	.27	58	175	▲	◆	2	700	
								.30	62	185					
								.40	65	195					
								● ext-int finish .BK-BK   .WH-BK		■ .15   .30   .45					

NSES	ref.	dimensions mm.	inst.	finish	optic options	power	CRI	K	eff. Lm/W	lumen max.	dimm opt.	tech opt.	watt max.	mA	sketch
	K51300	.02 75x45x50	.RF	●	■	.ST	.9	.27	67	335	▲	◆	4	700	
								.30	69	345					
								.40	71	355					
								● ext-int finish .BK-BK   .WH-BK		■ .15   .30   .45					

NSES	ref.	dimensions mm.	inst.	finish	optic options	power	CRI	K	eff. Lm/W	lumen max.	dimm opt.	tech opt.	watt max.	mA	sketch
	K51300	.03 105x45x50	.RF	●	■	.ST	.9	.27	69	480	▲	◆	6	700	
								.30	74	520					
								.40	80	560					
								● ext-int finish .BK-BK   .WH-BK		■ .15   .30   .45					

\*1 / \*2 Dimming options require the combination of a minimum of 3 luminaires/2 luminaires respectively. / Las opciones de regulación necesitan la combinación de un mínimo de 3 luminarias/2 luminarias respectivamente.

nseS

K51300

indoor



Other installations / Otras instalaciones.

pag. 18 .SR

pag. 134 .TR

pag. 157 .TK

NSES	ref.	dimensions mm.	inst.	finish	optic options	power	CRI	K	eff. Lm/W	lumen max.	dimm opt.	tech opt.	watt max.	mA	sketch
	K51300	.04 147x45x50	.RF	●	■	.ST	.9	.27	70	835	▲	◆	10	700	
								.30	73	875					
								.40	76	915					
								● ext-int finish .BK-BK   .WH-BK		■ .15   .30   .45					

NSES	ref.	dimensions mm.	inst.	finish	optic options	power	CRI	K	eff. Lm/W	lumen max.	dimm opt.	tech opt.	watt max.	mA	sketch
	K51300	.05 280x45x50	.RF	●	■	.ST	.9	.27	68	1430	▲	◆	20	600	
								.30	73	1530					
								.40	78	1630					
								● ext-int finish .BK-BK   .WH-BK		■ .15   .30   .45					



make your versus style

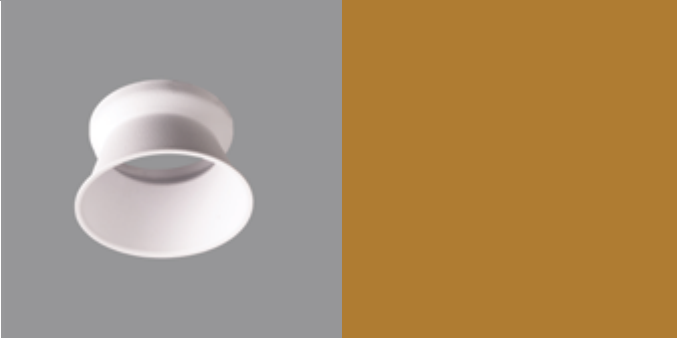

# versus

K51100

- ALUMINIUM
- IP20 / IP23
- IK03
- LIGHT DIRECTION FIXED
- DIM OPTIONAL
- HONEYCOMB
- REMOTE
- 0°
- 0°
- INDOOR
- 220-240 V / 50-60 Hz
- LIFE 50,000h
- WARRANTY 5 Years
- CE
- RF

VERSUS	ref.	dimensions mm.	inst.	finish	optic options	power	CRI	K	eff. Lm/W <sup>*1</sup>	lumen max. <sup>*1</sup>	dimming opt.	tech opt.	watt max.	mA	sketch	
	K51100	.01 Ø60x70	.RF	●	■	.ST	.8	80	.30	74	400	▲	●	5	120	
									.40	77	420					
		55 mm.	20 mm.	● ext-int finish .BK-BK   .BK-GL   .BK-WH .WH-BK   .WH-GL   .WH-WH			■ .38	▲ .DA   .PU   .D1   .PC		●	● ■ ▲ K51100.01.RF.XX.38.ST.8.XX.XX					

VERSUS	ref.	dimensions mm.	inst.	finish	optic options	power	CRI	K	eff. Lm/W <sup>*1</sup>	lumen max. <sup>*1</sup>	dimming opt.	tech opt.	watt max.	mA	sketch	
	K51100	.02 Ø73x87	.RF	●	■	.ST	.8	80	.30	75	885	▲	●	10	250	
									.40	82	965					
		66 mm.	20 mm.	● ext-int finish .BK-BK   .BK-GL   .BK-WH .WH-BK   .WH-GL   .WH-WH			■ .38	▲ .DA   .PU   .PC		●	● ■ ▲ K51100.02.RF.XX.38.ST.8.XX.XX					

VERSUS	ref.	dimensions mm.	inst.	finish	optic options	power	CRI	K	eff. Lm/W <sup>*1</sup>	lumen max. <sup>*1</sup>	dimming opt.	tech opt.	watt max.	mA	sketch	
	K51100	.03 Ø80x100	.RF	●	■	.ST	.8	80	.30	91	1275	▲	●	15	350	
									.40	91	1275					
		75 mm.	20 mm.	● ext-int finish .BK-BK   .BK-GL   .BK-WH .WH-BK   .WH-GL   .WH-WH			■ .38	▲ .DA   .PU   .D1   .PC		●	● ■ ▲ K51100.03.RF.XX.38.ST.8.XX.XX					

\*1 Please might expect a max. 15% value reduction in finishes other than white. / Puede haber una reducción máx. del 15% en el dato de los acabados distintos al blanco.

indoor

RF



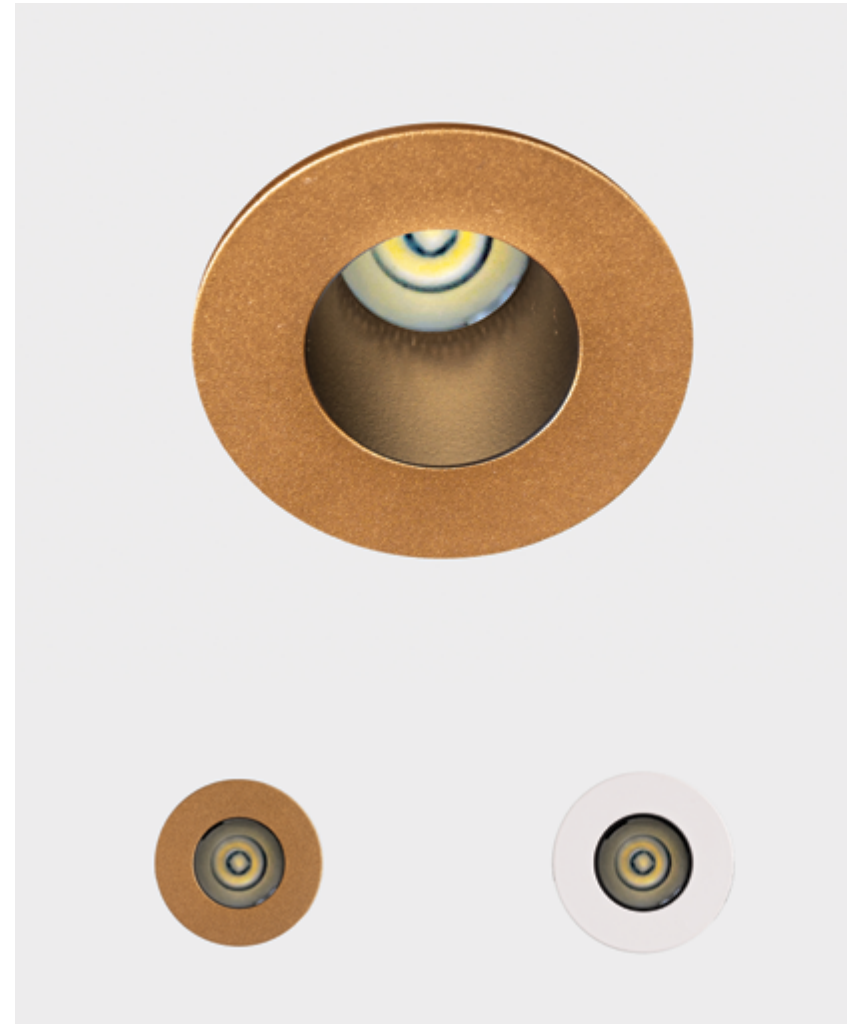

# versus litl

K51103

indoor

- ALUMINIUM
- IP20 / IP32
- IK05
- LIGHT DIRECTION FIXED
- DIM OPTIONAL
- REMOTE
- 0°
- 0°
- INDOOR
- 220-240 V 50-60 Hz
- RF
- LIFE 50.000h
- WARRANTY 5 Years
- CE
- RoHS

VERSUS LITL	ref.	dimensions mm.	inst.	finish	optic options	power	CRI	K	eff. Lm/W*1	lumen max.*1	dimming opt.	tech opt.	watt max.	mA	sketch
	<b>K51103</b>	.01 Ø44x40	.RF	●	■	.ST	.8	80	.27	30	90	▲	3	600	
									.30	44	133				
									.40	44	133				
		 <b>.GC-BK   .WH-BK</b>			 <b>.DA   .PU   .D1</b>		 <b>K51103.01.RF.XX.30.ST.B.X.XX</b>								

\*1 Please might expect a max. 15% value reduction in finishes other than white. / Puede haber una reducción máx. del 15% en el dato de los acabados distintos al blanco.  
 \*2 Dimming options require the combination of a minimum of 3 luminaires. / Las opciones de regulación necesitan la combinación de un mínimo de 3 luminarias.

indoor

RF



# versus muzzy

K51101

- ALUMINIUM
- IP20 / IP33
- IK05
- LIGHT DIRECTION FIXED
- DIM OPTIONAL
- REMOTE
- 0°
- 0°
- INDOOR
- 220-240 V 50-60 Hz
- LIFE 50.000h
- WARRANTY 5 Years
- CE
- RoHS

VERSUS MUZZY	ref.	dimensions mm.	inst.	finish	optic options	power	CRI		K	eff. Lm/W*1	lumen max.*1	dimm opt.	tech opt.	watt max.	mA	sketch
	K51101	.01 Ø56x72	.RF	●	■	.ST	.9	90	.27	70	565	▲	◆	8	200	
									.30	70	565					
									.40	72	575					
Ø48		20 mm.		● ext-int finish .BK-BK   .WH-WH		.16   .25   .36		▲ .DA   .PU   .D1								K51101.01.RF.XX.XX.ST.9.XX.XX

\*1 Please might expect a max. 15% value reduction in finishes other than white. / Puede haber una reducción máx. del 15% en el dato de los acabados distintos al blanco.



indoor

RF



# versus muzzy sq

K51102

- ALUMINIUM
- IP20 / IP33
- IK05
- LIGHT DIRECTION FIXED
- DIM OPTIONAL
- REMOTE
- 0°
- 0°
- INDOOR
- 220-240 V / 50-60 Hz
- LIFE 50.000h
- WARRANTY 5 Years
- CE
- RoHS

VERSUS MUZZY SQ	ref.	dimensions mm.	inst.	finish	optic options	power	CRI	K	eff. Lm/W*1	lumen max.*1	dimm opt.	tech opt.	watt max.	mA	sketch	
	<b>K51102</b>	<b>.01</b> 56x56x72	<b>.RF</b>	●	■	<b>.ST</b>	<b>.9</b>	90	<b>.27</b>	50	565	▲	◆	9	200	
									<b>.30</b>	52	565					
									<b>.40</b>	54	575					
			● ext-int finish <b>.BK-BK   .WH-WH</b>			<b>.16   .25   .36</b>		<b>.DA   .PU   .D1</b>		<b>K51102.01.RF.XX.XX.ST.9.XX.XX</b>						

\*1 Please might expect a max. 15% value reduction in finishes other than white. / Puede haber una reducción máx. del 15% en el dato de los acabados distintos al blanco.



indoor

RF



# luxo tilt

K50151

- ALUMINIUM
- IP20 / IP32
- IK05
- LIGHT DIRECTION ADJUSTABLE
- DIM OPTIONAL
- UGR 19
- REMOTE
- 20°
- 0°
- INDOOR
- 220-240 V / 50-60 Hz
- LIFE 50.000h
- WARRANTY 5 Years
- CE
- RoHS

LUXO TILT	ref.	dimensions mm.	inst.	finish	optic options	power	CRI	K	eff. Lm/W <sup>*1</sup>	lumen max. <sup>*1</sup>	dimmt opt.	tech opt.	watt max.	mA	sketch	
	<b>K50151</b>	<b>.01</b> Ø105x73	<b>.RF</b>	●	■	<b>.ST</b>	<b>.9</b>	90	<b>.27</b>	63	810	▲	●	12	300	
									<b>.30</b>	66	850					
									<b>.40</b>	68	880					
				● ext-int finish				■ <sup>*2</sup>	.DA   .PU   .D1   .PC		●			<b>K50151.01.RF.XX.XX.ST.9.XX.XX</b>		

<sup>\*1</sup> Please might expect a max. 15% value reduction in finishes other than white. / Puede haber una reducción máx. del 15% en el dato de los acabados distintos al blanco.  
<sup>\*2</sup> UGRs19 only for optic options 15° and 25°. Luminaire sold with a default of 38° degrees. Options for optics range from 15°, 25° and 60°. Please see the accessories page for more information. All accessories are shipped without being mounted to the luminaire. / UGRs19 solo en opciones ópticas 15° and 25°. Ver las opciones de ópticas 15°, 25° y 60° en la página de accesorios. La luminaria se vende con 38 ° por defecto. Los accesorios se envían sin montar en la luminaria.





# luxo IP65

K50153

indoor

- ALUMINIUM
- IP20 / IP65
- IK05
- LIGHT DIRECTION FIXED
- DIM OPTIONAL
- REMOTE
- 0°
- 0°
- INDOOR OUTDOOR
- 220-240 V 50-60 Hz
- WARRANTY 5 Years
- CE
- RF

LUXO IP65	ref.	dimensions mm.	inst.	finish	optic options	power	CRI	K	eff. Lm/W <sup>2</sup>	lumen max.*1	dimming opt.	tech opt.	watt max.	mA	sketch
	<b>K50153</b>	<b>.01</b> Ø85x55	<b>.RF</b>	●	■	<b>.ST</b>	<b>.9</b> 90	<b>.27</b>	85	1065	▲	◆	12	300	
								<b>.30</b>	86	1075					
								<b>.40</b>	88	1100					
		● ext-int finish <b>.BK-BK   .WH-WH</b>		15   25   <b>.38</b>   60	<b>.DA   .PU   .D1   .PC</b>		<b>K50153.01.RF.XX.38.ST.9.XX.XX</b>								

\*1 Please might expect a max. 15% value reduction in finishes other than white. / Puede haber una reducción máx. del 15% en el dato de los acabados distintos al blanco.  
<sup>2</sup> UGRs19 only for optic options 15° and 25°. Luminaire sold with a default of 38° degrees. Options for optics range from 15°, 25° and 60°. Please see the accessories page for more information. All accessories are shipped without being mounted to the luminaire. / UGRs19 solo en opciones ópticas 15° and 25°. Ver las opciones de ópticas 15°, 25° y 60° en la página de accesorios. La luminaria se vende con 38° por defecto. Los accesorios se envían sin montar en la luminaria.

indoor

RF



# luxo

## K50150

- ALUMINIUM
- IP20 / IP32
- IK05
- LIGHT DIRECTION FIXED
- DIM OPTIONAL
- UGR ≤ 19
- REMOTE
- 0°
- 0°
- INDOOR
- 220-240 V 50-60 Hz
- LIFE 50,000h
- WARRANTY 5 Years
- CE
- RoHS

LUXO	ref.	dimensions mm.	inst.	finish	optic options	power	CRI	K	eff. Lm/W*1	lumen max.*1	dim opt.	tech opt.	watt max.	mA	sketch	
	K50150	.01 Ø85x65	.RF	●	■	.ST	.9	90	.27	92	780	▲	◆	8	200	
									.30	95	800					
									.40	100	860					
	Ø76	10 mm.	● ext-int finish .BK-BK   .WH-WH		■ <sup>2</sup>	15   25   .38   60	▲	◆	● ■ ▲		K50150.01.RF.XX.38.ST.9.XX.XX					

LUXO	ref.	dimensions mm.	inst.	finish	optic options	power	CRI	K	eff. Lm/W*1	lumen max.*1	dim opt.	tech opt.	watt max.	mA	sketch	
	K50150	.02 Ø100x75	.RF	●	■	.ST	.9	90	.27	85	1065	▲	◆	12	300	
									.30	88	1100					
									.40	90	1130					
	Ø90	10 mm.	● ext-int finish .BK-BK   .WH-WH		■ <sup>2</sup>	15   25   .38   60	▲	◆	● ■ ▲		K50150.02.RF.XX.XX.ST.9.XX.XX					

LUXO	ref.	dimensions mm.	inst.	finish	optic options	power	CRI	K	eff. Lm/W*1	lumen max.*1	dim opt.	tech opt.	watt max.	mA	sketch	
	K50150	.03 Ø120x98	.RF	●	■	.ST	.9	90	.27	88	1835	▲	◆	20	500	
									.30	90	1890					
									.40	92	1920					
	Ø113	10 mm.	● ext-int finish .BK-BK   .WH-WH		■ <sup>2</sup>	15   25   .38	▲	◆	● ■ ▲		K50150.03.RF.XX.XX.ST.9.XX.XX					

\*1 Please might expect a max. 15% value reduction in finishes other than white. / Puede haber una reducción máx. del 15% en el dato de los acabados distintos al blanco.  
 \*2 UGRs19 only for optic options 15° and 25°. Luminaire sold with a default of 38° degrees. Options for optics range from 15°, 25° and 60°. Please see the accessories page for more information. All accessories are shipped without being mounted to the luminaire. / UGRs19 solo en opciones ópticas 15° and 25°. Ver las opciones de ópticas 15°, 25° y 60° en la página de accesorios. La luminaria se vende con 38° por defecto. Los accesorios se envían sin montar en la luminaria.

indoor

RF



# luxo dara

## K50300

- ALUMINIUM
- IP20 / IP54
- IK06
- LIGHT DIRECTION FIXED
- DIM OPTIONAL
- HONEYCOMB
- REMOTE
- 0°
- 0°
- INDOOR / OUTDOOR
- 220-240 V 50-60 Hz
- LIFE 50,000h
- WARRANTY 5 Years
- CE
- RoHS

LUXO DARA	ref.	dimensions mm.	inst.	finish	optic options	power	CRI	K	eff. Lm/W	lumen max.	dim opt.	tech opt.	watt max.	mA	sketch	
	K50300	.01 Ø100x85	.RF	●	■	.ST	.9	90	.30	89	700	▲	◆	7	300	
									.40	89	740					
	Ø86 mm.	25 mm.	● ext-int finish .WH-WH		■ <sup>1</sup>	15   25   .40   60	▲	◆	● ■ ▲		K50300.01.RF.XX.XX.ST.8.XX.XX					



LUXO DARA	ref.	dimensions mm.	inst.	finish	optic options	power	CRI	K	eff. Lm/W	lumen max.	dim opt.	tech opt.	watt max.	mA	sketch	
	K50300	.02 Ø160x110	.RF	●	■	.ST	.9	90	.30	80	1660	▲	◆	20	500	
									.40	88	1830					
	Ø145 mm.	25 mm.	● ext-int finish .WH-WH		■ <sup>1</sup>	15   25   .40   60	▲	◆	● ■ ▲		K50300.02.RF.XX.XX.ST.8.XX.XX					



LUXO DARA	ref.	dimensions mm.	inst.	finish	optic options	power	CRI	K	eff. Lm/W	lumen max.	dim opt.	tech opt.	watt max.	mA	sketch	
	K50300	.03 Ø190x130	.RF	●	■	.ST	.9	90	.30	102	3060	▲	◆	30	750	
									.40	106	3180					
	Ø175 mm.	25 mm.	● ext-int finish .WH-WH		■ <sup>1</sup>	25   .40   60	▲	◆	● ■ ▲		K50300.03.RF.XX.XX.ST.8.XX.XX					



\*1 Luminaire sold with a default of 40° degrees. Options for optics range from 15°, 25° and 60°. Please see the accessories page for more information. All accessories are shipped without being mounted to the luminaire. / Ver las opciones de ópticas 15°, 25° y 60° en la página de accesorios. La luminaria se vende con 40° por defecto. Los accesorios se envían sin montar en la luminaria.



## LUXO ACCESORIES ACCESORIOS LUXO

### Reflector luxo

luminaire ref.	optic option	optic options ref.
K50150.01 K50153.01		KAC50150.01.15
		KAC50150.01.25
		KAC50150.01.60



K50150.02		KAC50150.02.15
		KAC50150.02.25
		KAC50150.02.60



K50150.03		KAC50150.03.15
		KAC50150.03.25



K50151.01		KAC50151.01.15
		KAC50151.01.25
		KAC50151.01.60

## LUXO DARA ACCESORIES ACCESORIOS LUXO DARA

### Reflector luxo dara

luminaire ref.	optic option	optic options ref.
K50300.01		KAC50300.01.15
		KAC50300.01.25
		KAC50300.01.60

K50300.02		KAC50300.02.15
		KAC50300.02.25
		KAC50300.02.60

K50300.03		KAC50300.03.25
		KAC50300.03.60

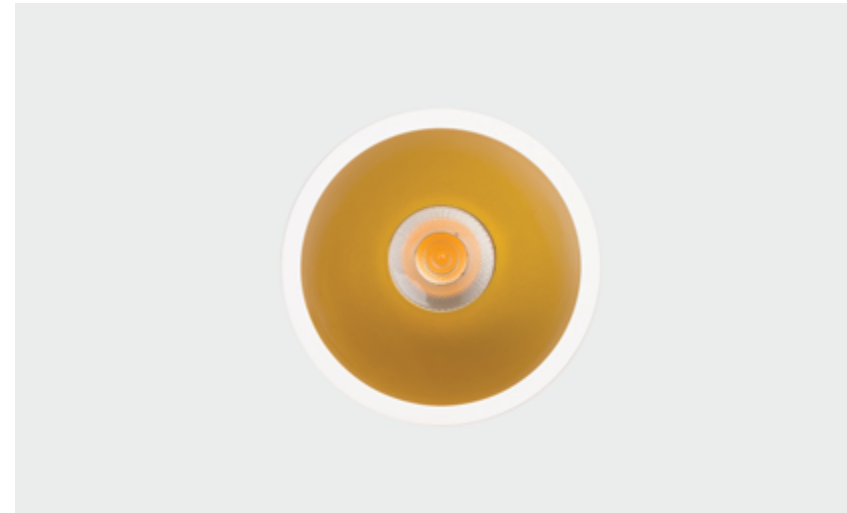
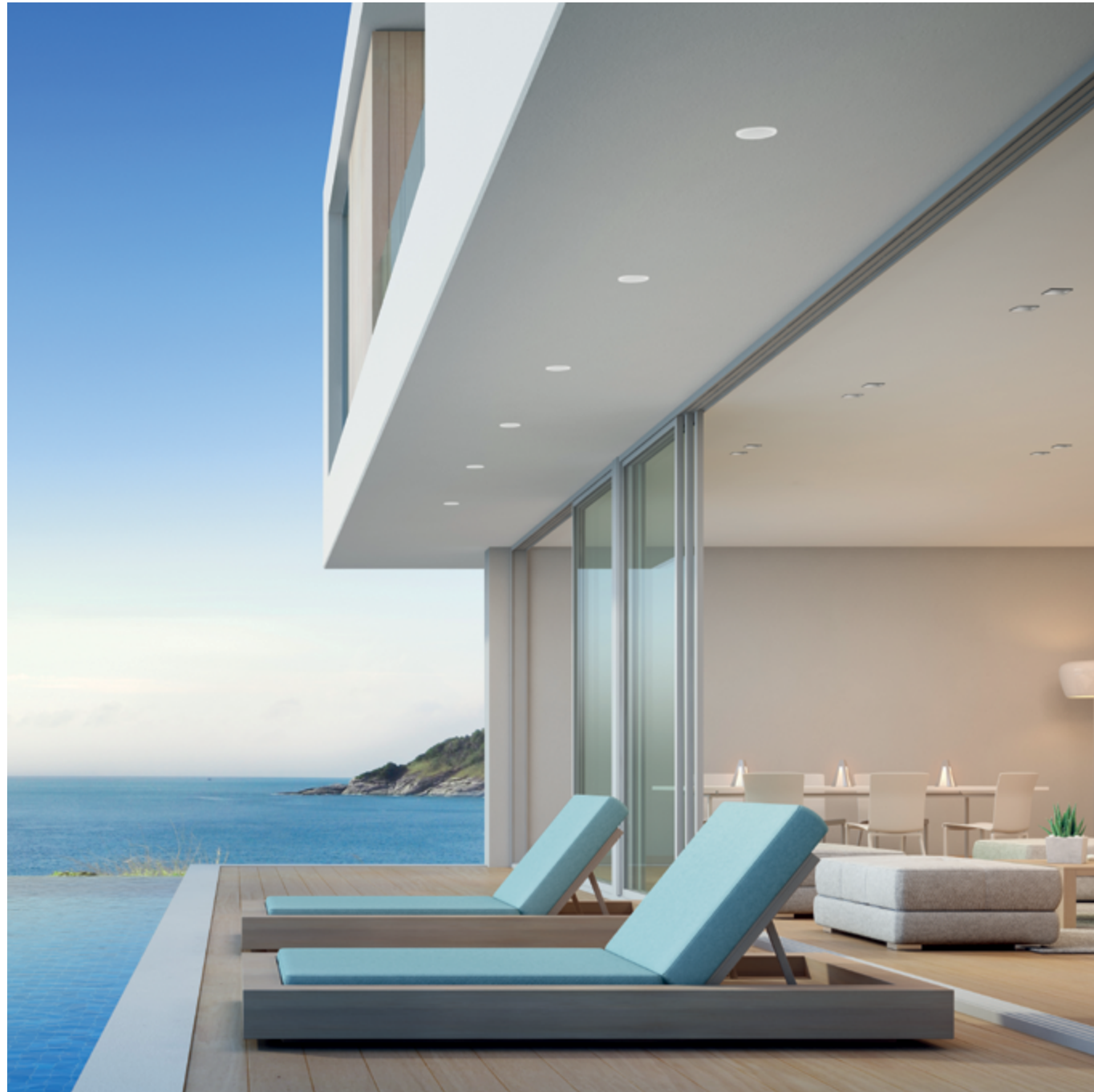

noon  
K50800



indoor

RF

NOON	ref.	dimensions mm.	inst.	finish	optic options	power	CRI	K	eff. Lm/W <sup>*1</sup>	lumen max. <sup>*1</sup>	dim. opt.	tech. opt.	watt max.	mA	sketch	
	K50800	.01 Ø70x80	.RF	●	■	.ST	.8	80	.27	78	470	▲	◆	5	135	
									.30	80	480					
									.40	82	490					
		62 mm.		20 mm.	● ext-int. finish .BK-BK   .WH-GL   .WH-WH	■ .38	▲ .DA   .PU   .D1   .PC	◆	● ■ ▲ K50800.01.RF.XX.38.ST.8.XX.XX							

NOON	ref.	dimensions mm.	inst.	finish	optic options	power	CRI	K	eff. Lm/W <sup>*1</sup>	lumen max. <sup>*1</sup>	dim. opt.	tech. opt.	watt max.	mA	sketch	
	K50800	.02 Ø83x83,5	.RF	●	■	.ST	.8	80	.27	77	575	▲	◆	7	160	
									.30	78	585					
									.40	79	660					
		75 mm.		20 mm.	● ext-int. finish .BK-BK   .WH-GL   .WH-WH	■ .38	▲ .DA   .PU   .D1   .PC	◆	● ■ ▲ K50800.02.RF.XX.38.ST.8.XX.XX							

NOON	ref.	dimensions mm.	inst.	finish	optic options	power	CRI	K	eff. Lm/W <sup>*1</sup>	lumen max. <sup>*1</sup>	dim. opt.	tech. opt.	watt max.	mA	sketch	
	K50800	.03 Ø93x100	.RF	●	■	.ST	.8	80	.27	85	890	▲	◆	10	250	
									.30	86	900					
									.40	87	910					
		85 mm.		20 mm.	● ext-int. finish .BK-BK   .WH-GL   .WH-WH	■ .38	▲ .DA   .PU   .D1   .PC	◆	● ■ ▲ K50800.03.RF.XX.38.ST.8.XX.XX							

\*1 Please might expect a max. 15% value reduction in finishes other than white. / Puede haber una reducción máx. del 15% en el dato de los acabados distintos al blanco.



indoor

RF



# noon asymmetric

K50804

- ALUMINIUM PC
- IP20 / IP23
- IK08
- LIGHT DIRECTION FIXED
- DIM OPTIONAL
- REMOTE
- 0°
- 220-240 V 50-60 Hz
- LIFE 50.000h
- WARRANTY 5 Years
- CE
- RoHS

NOON ASYMETRIC	ref.	dimensions mm.	inst.	finish	optic options	power	CRI	K	eff. Lm/W*1	lumen max.*1	dimmm opt.	tech opt.	watt max.	mA	sketch	
	K50804	.01 Ø93x100	.RF	●	■	.ST	.8	80	.30	78	585	▲	◆	7	160	
									.40	79	595					
								75 mm.	20 mm.	● ext-int finish .BK-BK   .WH-WH	■ .38					

\*1 Please might expect a max. 15% value reduction in finishes other than white. / Puede haber una reducción máx. del 15% en el dato de los acabados distintos al blanco.

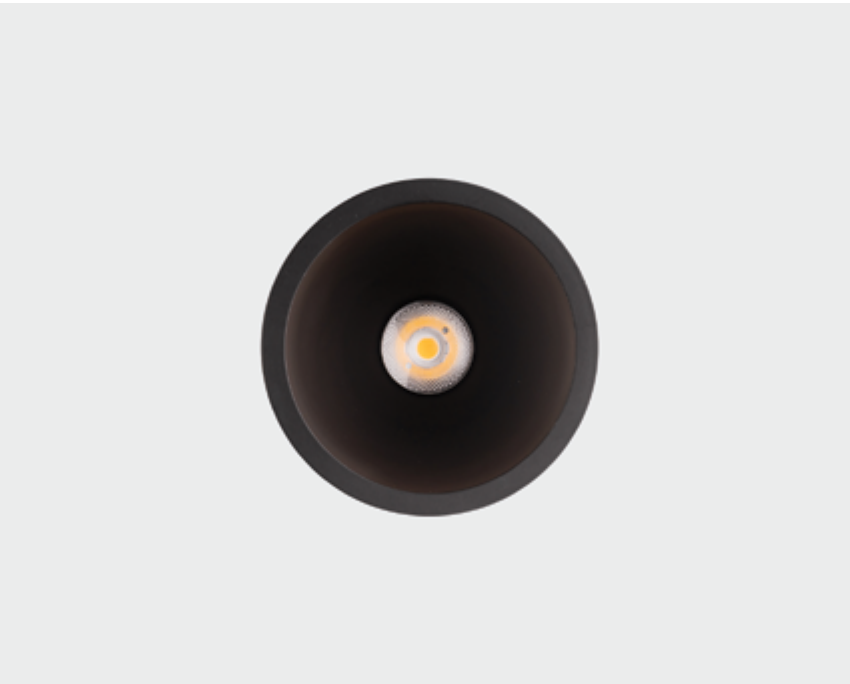

# noon IP65

K50803

- ALUMINIUM PC
- IP20 / IP65
- IK08
- LIGHT DIRECTION FIXED
- DIM OPTIONAL
- REMOTE
- 0°
- 220-240 V 50-60 Hz
- LIFE 50.000h
- WARRANTY 5 Years
- CE
- RoHS

indoor

RF

NOON IP65	ref.	dimensions mm.	inst.	finish	optic options	power	CRI	K	eff. Lm/W*1	lumen max.*1	dimmm opt.	tech opt.	watt max.	mA	sketch	
	K50803	.01 Ø83x85	.RF	●	■	.ST	.8	80	.27	77	575	▲	◆	7	160	
									.30	78	585					
									.40	79	595					
75 mm.	20 mm.	● ext-int finish .BK-BK   .WH-WH	■ .38	▲ .DA   .PU   .D1   .PC	◆	● ■ ▲ K50803.01.RF.XX.38.ST.8.XX.XX										

NOON IP65	ref.	dimensions mm.	inst.	finish	optic options	power	CRI	K	eff. Lm/W*1	lumen max.*1	dimmm opt.	tech opt.	watt max.	mA	sketch	
	K50803	.02 Ø93x100	.RF	●	■	.ST	.8	80	.27	85	890	▲	◆	10	250	
									.30	86	900					
									.40	87	910					
85 mm.	20 mm.	● ext-int finish .BK-BK   .WH-WH	■ .38	▲ .DA   .PU   .D1   .PC	◆	● ■ ▲ K50803.02.RF.XX.38.ST.8.XX.XX										

\*1 Please might expect a max. 15% value reduction in finishes other than white. / Puede haber una reducción máx. del 15% en el dato de los acabados distintos al blanco.

indoor

RF

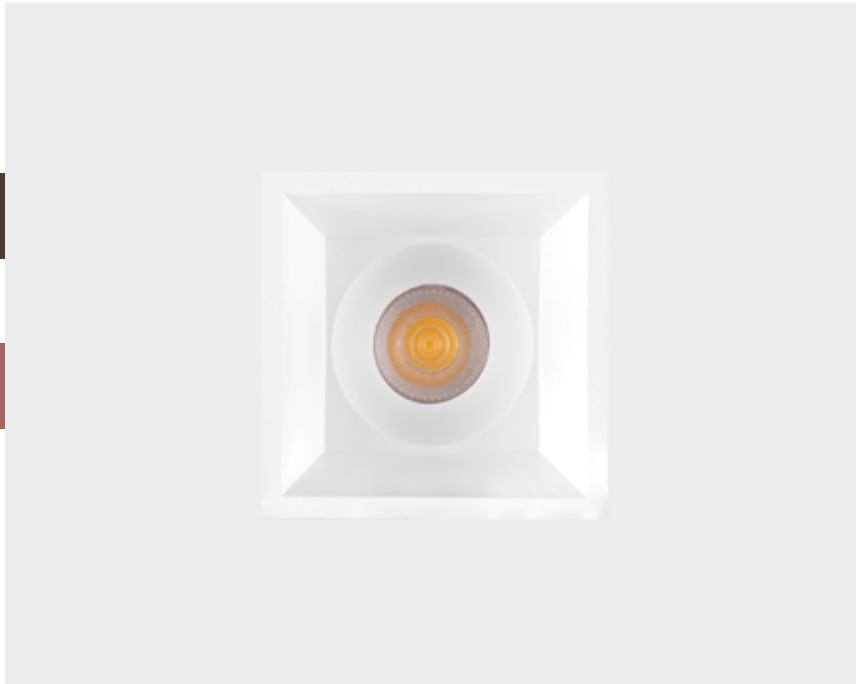

# noon sq

K50805

- ALUMINIUM PC
- IP20 / IP23
- IK08
- LIGHT DIRECTION FIXED
- DIM OPTIONAL
- REMOTE
- 0°
- INDOOR
- 220-240 V 50-60 Hz
- LIFE 50.000h
- WARRANTY 5 Years
- CE

NOON SQ	ref.	dimensions mm.	inst.	finish	optic options	power	CRI	K	eff. Lm/W <sup>*1</sup>	lumen max. <sup>*1</sup>	dim opt.	tech opt.	watt max.	mA	sketch	
	K50805	.01 93x93x100	.RF	●	■	.ST	.8	80	.30	86	900	▲	●	10	250	
									.40	87	910					
		85x85 mm.	20 mm.	● ext-int finish .BK-BK   .WH-WH		■ .38	▲ .DA   .PU   .D1   .PC				●	K50805.01.RF.XX.38.ST.8.XX.XX				

<sup>\*1</sup> Please might expect a max. 15% value reduction in finishes other than white. / Puede haber una reducción máx. del 15% en el dato de los acabados distintos al blanco.

indoor

RF



# noon sq asymmetric

K50806

- ALUMINIUM PC
- IP20 / IP23
- IK08
- LIGHT DIRECTION FIXED
- DIM OPTIONAL
- REMOTE
- 0°
- INDOOR
- 220-240 V 50-60 Hz
- LIFE 50.000h
- WARRANTY 5 Years
- CE

NOON SQ ASYMETRIC	ref.	dimensions mm.	inst.	finish	optic options	power	CRI	K	eff. Lm/W <sup>*1</sup>	lumen max. <sup>*1</sup>	dim opt.	tech opt.	watt max.	mA	sketch	
	K50806	.01 93x93x100	.RF	●	■	.ST	.8	80	.30	80	480	▲	●	5	135	
									.40	82	490					
		85x85 mm.	20 mm.	● ext-int finish .BK-BK   .WH-WH		■ .38	▲ .DA   .PU   .D1   .PC				●	K50806.01.RF.XX.38.ST.8.XX.XX				

<sup>\*1</sup> Please might expect a max. 15% value reduction in finishes other than white. / Puede haber una reducción máx. del 15% en el dato de los acabados distintos al blanco.

indoor

RF



# rebecca

K53270

- ALUMINIUM
- IP20 / IP23
- IK05
- LIGHT DIRECTION ADJUSTABLE
- DIM OPTIONAL
- HONEYCOMB
- REMOTE
- 30°
- 350°
- INDOOR
- 220-240 V 50-60 Hz
- LIFE 50.000h
- WARRANTY 5 Years
- CE
- RoHS

indoor

RF



# rebecca sq

K53271

- ALUMINIUM
- IP20 / IP23
- IK05
- LIGHT DIRECTION ADJUSTABLE
- DIM OPTIONAL
- HONEYCOMB
- REMOTE
- 30°
- 350°
- INDOOR
- 220-240 V 50-60 Hz
- LIFE 50.000h
- WARRANTY 5 Years
- CE
- RoHS

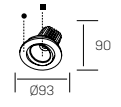
REBECCA	ref.	dimensions mm.	inst.	finish	optic options	power	CRI	K	eff. Lm/W	lumen max.	dim opt.	tech opt.	watt max.	mA	sketch
	K53270	.01 Ø93x90	.RF	●	■	.ST	.9	90	.30	78	▲	◆	10	300	
									.40	82					
		Ø80 mm.	25 mm.	● ext-int finish .ALUMN   .WH-WH		■ .20   .35		▲ .DA   .PU   .D1   .PC		◆		K53270.01.RF.XX.XX.ST.9.XX.XX			

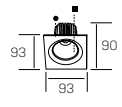
REBECCA SQ	ref.	dimensions mm.	inst.	finish	optic options	power	CRI	K	eff. Lm/W	lumen max.	dim opt.	tech opt.	watt max.	mA	sketch
	K53271	.01 93x93x90	.RF	●	■	.ST	.9	90	.30	78	▲	◆	10	300	
									.40	82					
		Ø80 mm.	25 mm.	● ext-int finish .ALUMN   .WH-WH		■ .20   .35		▲ .DA   .PU   .D1   .PC		◆		K53271.01.RF.XX.XX.ST.9.XX.XX			



lim  
K50320

indoor

RF

- ALUMINIUM
- IP20 / IP44
- K06
- LIGHT DIRECTION FIXED
- DIM OPTIONAL
- REMOTE
- 0°
- 0°
- INDOOR
- 220-240 V / 50-60 Hz
- LIFE 50.000h
- WARRANTY 5 Years
- CE
- RoHS

LIM	ref.	dimensions mm.	inst.	finish	optic options	power	CRI	K	eff. Lm/W*	lumen max.*1	dimming opt.	tech opt.	watt max.	mA	sketch	
	K50320	.01 Ø103x56,5	.RF	●	■	.ST	.8	80	.30	76	530	▲	◆	7	300	
									.40	83	580					
		Ø90 mm.	20 mm.	● ext-int finish .BK-BK   .WH-WH		■ .MP		▲ .DA   .PU   .D1		K50320.01.RF.XX.MP.ST.8.XX.XX						
	K50320	.02 Ø136x56,5	.RF	●	■	.ST	.8	80	.30	85	1030	▲	◆	12	300	
									.40	91	1100					
		Ø120 mm.	20 mm.	● ext-int finish .BK-BK   .WH-WH		■ .MP		▲ .DA   .PU   .D1   .PC		K50320.02.RF.XX.MP.ST.8.XX.XX						
	K50320	.03 Ø176x60	.RF	●	■	.ST	.8	80	.30	92	2200	▲	◆	25	600	
									.40	100	2400					
		Ø160 mm.	20 mm.	● ext-int finish .BK-BK   .WH-WH		■ .MP		▲ .DA   .PU   .D1   .PC		K50320.03.RF.XX.MP.ST.8.XX.XX						
	K50320	.04 Ø210x60	.RF	●	■	.ST	.8	80	.30	103	3080	▲	◆	30	750	
									.40	104	3110					
		Ø200 mm.	20 mm.	● ext-int finish .BK-BK   .WH-WH		■ .MP		▲ .DA   .PU   .D1		K50320.04.RF.XX.MP.ST.8.XX.XX						



indoor

RF



# lim sq

K50321

- ALUMINIUM
- IP20 / IP44
- IK06
- LIGHT DIRECTION FIXED
- DIM OPTIONAL
- REMOTE
- 0°
- 220-240 V 50-60 Hz
- LIFE 50.000h
- WARRANTY 5 Years
- CE

LIM SQ	ref.	dimensions mm.	inst.	finish	optic options	power	CRI	K	eff. Lm/W <sup>1</sup>	lumen max. <sup>1</sup>	dimm opt.	tech opt.	watt max.	mA	sketch	
	<b>K50321</b>	<b>.01</b> 103x103x56,5	<b>.RF</b>	●	■	<b>.ST</b>	<b>.8</b>	80	<b>.30</b>	76	530	▲	●	7	300	
									<b>.40</b>	83	580					
		$\varnothing$ 90 mm.	20 mm.		● ext-int finish <b>.BK-BK   .WH-WH</b>		■ <b>.MP</b>		▲ <b>.DA   .PU   .D1</b>		● <b>K50321.01.RF.XX.MP.ST.8.XX.XX</b>					
	<b>K50321</b>	<b>.02</b> 136x136x56,5	<b>.RF</b>	●	■	<b>.ST</b>	<b>.8</b>	80	<b>.30</b>	85	1030	▲	●	12	300	
									<b>.40</b>	91	1100					
		$\varnothing$ 120 mm.	20 mm.		● ext-int finish <b>.BK-BK   .WH-WH</b>		■ <b>.MP</b>		▲ <b>.DA   .PU   .D1   .PC</b>		● <b>K50321.02.RF.XX.MP.ST.8.XX.XX</b>					
	<b>K50321</b>	<b>.03</b> 176x176x60	<b>.RF</b>	●	■	<b>.ST</b>	<b>.8</b>	80	<b>.30</b>	92	2200	▲	●	25	600	
									<b>.40</b>	100	2400					
		$\varnothing$ 160 mm.	20 mm.		● ext-int finish <b>.BK-BK   .WH-WH</b>		■ <b>.MP</b>		▲ <b>.DA   .PU   .D1   .PC</b>		● <b>K50321.03.RF.XX.MP.ST.8.XX.XX</b>					
	<b>K50321</b>	<b>.04</b> 210x210x60	<b>.RF</b>	●	■	<b>.ST</b>	<b>.8</b>	80	<b>.30</b>	103	3080	▲	●	30	750	
									<b>.40</b>	104	3110					
		$\varnothing$ 200 mm.	20 mm.		● ext-int finish <b>.BK-BK   .WH-WH</b>		■ <b>.MP</b>		▲ <b>.DA   .PU   .D1</b>		● <b>K50321.04.RF.XX.MP.ST.8.XX.XX</b>					



▲

▲ K55006 flow

indoor

RF



# lim lacus

K53300

- ALUMINIUM
- IP20 / IP44
- IK06
- LIGHT DIRECTION FIXED
- DIM OPTIONAL
- REMOTE
- 0°
- INDOOR
- 220-240 V 50-60 Hz
- LIFE 50.000h
- WARRANTY 5 Years
- CE
- RoHS

LIM LACUS	ref.	dimensions mm.	inst.	finish	optic options	power	CRI	K	eff. Lm/W <sup>1</sup>	lumen max. <sup>1</sup>	dim. opt.	tech. opt.	watt max.	mA	sketch
	K53300	.01 Ø108x38	.RF	●	■	.ST	.8	80	80	600	▲	◆	7	300	
								.40	93	700					
		Ø 88 mm.	45 mm.	● ext-int finish .BK-BK   .WH-WH		■ .OP	▲ .DA   .PU   .D1   .PC				◆		K53300.01.RF.XX.OP.ST.8.XX.XX		

LIM LACUS	ref.	dimensions mm.	inst.	finish	optic options	power	CRI	K	eff. Lm/W <sup>1</sup>	lumen max. <sup>1</sup>	dim. opt.	tech. opt.	watt max.	mA	sketch
	K53300	.02 Ø142x38	.RF	●	■	.ST	.8	80	89	1250	▲	◆	15	350	
								.40	92	1350					
		Ø 120 mm.	45 mm.	● ext-int finish .BK-BK   .WH-WH		■ .OP	▲ .DA   .PU   .D1   .PC				◆		K53300.02.RF.XX.OP.ST.8.XX.XX		

LIM LACUS	ref.	dimensions mm.	inst.	finish	optic options	power	CRI	K	eff. Lm/W <sup>1</sup>	lumen max. <sup>1</sup>	dim. opt.	tech. opt.	watt max.	mA	sketch
	K53300	.03 Ø225x42	.RF	●	■	.ST	.8	80	100	2900	▲	◆	30	750	
								.40	108	3100					
		Ø 200 mm.	45 mm.	● ext-int finish .BK-BK   .WH-WH		■ .OP	▲ .DA   .PU   .D1				◆		K53300.03.RF.XX.OP.ST.8.XX.XX		

indoor

RF



# lim miranda

K53100

- ALUMINIUM
- IP20 / IP44
- IK03
- LIGHT DIRECTION FIXED
- DIM OPTIONAL
- REMOTE
- 0°
- INDOOR
- 220-240 V 50-60 Hz
- LIFE 50.000h
- WARRANTY 5 Years
- CE
- RoHS

LIM MIRANDA	ref.	dimensions mm.	inst.	finish	optic options	power	CRI	K	eff. Lm/W	lumen max.	dim. opt.	tech. opt.	watt max.	mA	sketch
	K53100	.01 Ø120x27	.RF	●	■	.ST	.8	80	.30	70	▲	◆	8	200	
								.40	79	730					
		Ø 115	20 mm.	● ext-int finish .WH-WH		■ .OP	▲ .DA   .PU   .D1   .PC				◆		K53100.01.RF.XX.OP.ST.8.XX.XX		

LIM MIRANDA	ref.	dimensions mm.	inst.	finish	optic options	power	CRI	K	eff. Lm/W	lumen max.	dim. opt.	tech. opt.	watt max.	mA	sketch
	K53100	.02 Ø172x27	.RF	●	■	.ST	.8	80	.30	80	▲	◆	15	350	
								.40	90	1400					
		Ø 160	20 mm.	● ext-int finish .WH-WH		■ .OP	▲ .DA   .PU   .D1   .PC				◆		K53100.02.RF.XX.OP.ST.8.XX.XX		

LIM MIRANDA	ref.	dimensions mm.	inst.	finish	optic options	power	CRI	K	eff. Lm/W	lumen max.	dim. opt.	tech. opt.	watt max.	mA	sketch
	K53100	.03 Ø225x27	.RF	●	■	.ST	.8	80	.30	73	▲	◆	22	600	
								.40	81	1900					
		Ø 215	20 mm.	● ext-int finish .WH-WH		■ .OP	▲ .DA   .PU   .D1   .PC				◆		K53100.03.RF.XX.OP.ST.8.XX.XX		



▲ K53100 lim miranda



# lim miranda sq K53105



indoor

RF

LIM MIRANDA SQ	ref.	dimensions mm.	inst.	finish	optic options	power	CRI	K	eff. Lm/W	lumen max.	dimmt opt.	tech opt.	watt max.	mA	sketch	
	<b>K53105</b>	<b>.01</b> 120x120x27	<b>.RF</b>	●	■	<b>.ST</b>	<b>.8</b>	80	<b>.30</b>	70	650	▲	◆	8	200	
									<b>.40</b>	79	730					
		● ext-int finish <b>.WH-WH</b>		■ <b>.OP</b>	▲ <b>.DA   .PU   .D1   .PC</b>		◆	● ■ ▲ <b>K53105.01.RF.XX.OP.ST.8.XX.XX</b>								

LIM MIRANDA	ref.	dimensions mm.	inst.	finish	optic options	power	CRI	K	eff. Lm/W	lumen max.	dimmt opt.	tech opt.	watt max.	mA	sketch	
	<b>K53105</b>	<b>.02</b> 172x172x27	<b>.RF</b>	●	■	<b>.ST</b>	<b>.8</b>	80	<b>.30</b>	80	1250	▲	◆	15	350	
									<b>.40</b>	90	1400					
		● ext-int finish <b>.WH-WH</b>		■ <b>.OP</b>	▲ <b>.DA   .PU   .D1   .PC</b>		◆	● ■ ▲ <b>K53105.02.RF.XX.OP.ST.8.XX.XX</b>								

LIM MIRANDA	ref.	dimensions mm.	inst.	finish	optic options	power	CRI	K	eff. Lm/W	lumen max.	dimmt opt.	tech opt.	watt max.	mA	sketch	
	<b>K53105</b>	<b>.03</b> 225x225x27	<b>.RF</b>	●	■	<b>.ST</b>	<b>.8</b>	80	<b>.30</b>	73	1700	▲	◆	22	600	
									<b>.40</b>	81	1900					
		● ext-int finish <b>.WH-WH</b>		■ <b>.OP</b>	▲ <b>.DA   .PU   .D1   .PC</b>		◆	● ■ ▲ <b>K53105.03.RF.XX.OP.ST.8.XX.XX</b>								

# disc

K51702

indoor

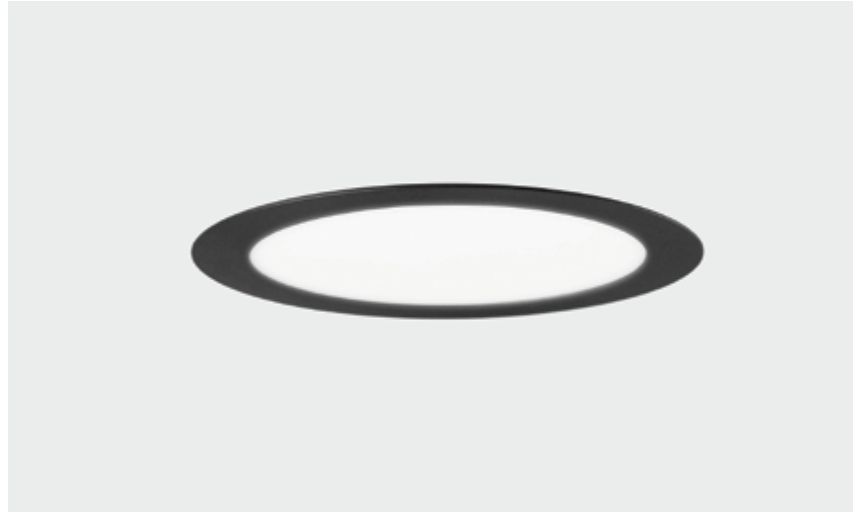

DISC	ref.	dimensions mm.	inst.	finish	optic options	power	CRI	K	eff. Lm/W	lumen max.	dim. opt.	tech. opt.	watt max.	mA	sketch		
	K51702	.01 Ø120x22	.RF	●	■	.ST	.8	80	.27	59	470	▲	◆	8	350		
									.30	62	480						
									.40	63	490						

DISC	ref.	dimensions mm.	inst.	finish	optic options	power	CRI	K	eff. Lm/W	lumen max.	dim. opt.	tech. opt.	watt max.	mA	sketch		
	K51702	.02 Ø172x22	.RF	●	■	.ST	.8	80	.27	85	1020	▲	◆	12	300		
									.30	83	1040						
									.40	85	1060						

DISC	ref.	dimensions mm.	inst.	finish	optic options	power	CRI	K	eff. Lm/W	lumen max.	dim. opt.	tech. opt.	watt max.	mA	sketch		
	K51702	.03 Ø225x22	.RF	●	■	.ST	.8	80	.27	85	1700	▲	◆	20	500		
									.30	90	1750						
									.40	92	1800						

DISC	ref.	dimensions mm.	inst.	finish	optic options	power	CRI	K	eff. Lm/W	lumen max.	dim. opt.	tech. opt.	watt max.	mA	sketch		
	K51702	.04 Ø300x22	.RF	●	■	.ST	.8	80	.27	98	2250	▲	◆	24	600		
									.30	98	2300						
									.40	100	2350						

DISC	ref.	dimensions mm.	inst.	finish	optic options	power	CRI	K	eff. Lm/W	lumen max.	dim. opt.	tech. opt.	watt max.	mA	sketch		
	K51702	.05 Ø400x30	.RF	●	■	.ST	.8	80	.27	92	2520	▲	◆	36	900		
									.30	95	3350						
									.40	96	3400						

DISC	ref.	dimensions mm.	inst.	finish	optic options	power	CRI	K	eff. Lm/W	lumen max.	dim. opt.	tech. opt.	watt max.	mA	sketch		
	K51702	.06 Ø500x30	.RF	●	■	.ST	.8	80	.27	85	4050	▲	◆	48	1200		
									.30	88	4100						
									.40	89	4150						

DISC	ref.	dimensions mm.	inst.	finish	optic options	power	CRI	K	eff. Lm/W	lumen max.	dim. opt.	tech. opt.	watt max.	mA	sketch		
	K51702	.07 Ø600x30	.RF	●	■	.ST	.8	80	.27	84	4700	▲	◆	56	1400		
									.30	87	4750						
									.40	88	4800						

indoor

RF



# disc sq

K51703

indoor

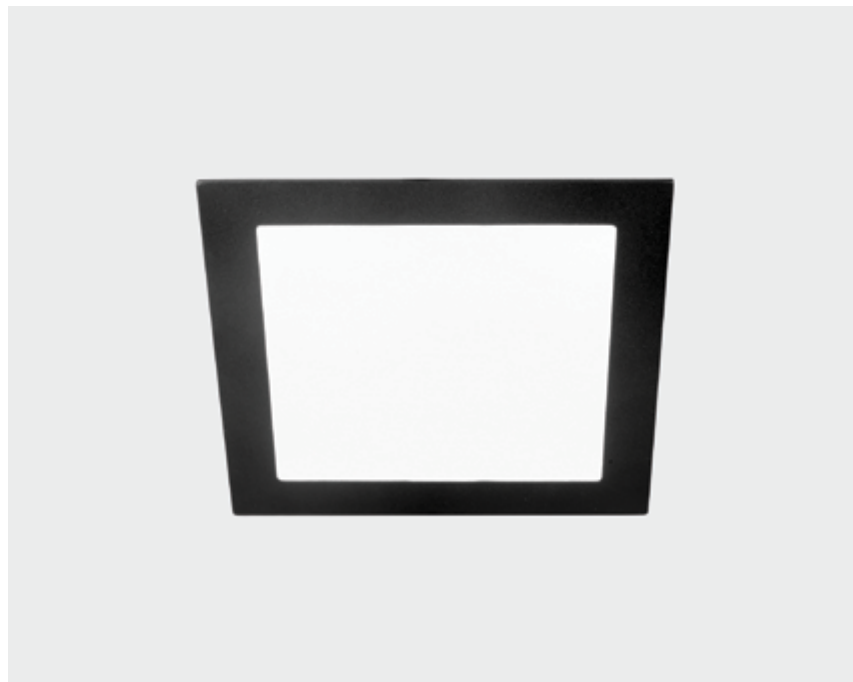

DISC SQ	ref.	dimensions mm.	inst.	finish	optic options	power	CRI	K	eff. Lm/W	lumen max.	dim. opt.	tech. opt.	watt max.	mA	sketch	
	K51703	.01 120x120x22	.RF	●	■	.ST	.8	80	.30	62	480	▲	◆	8	350	
									.40	63	490					
			● ext-int finish .BK-BK   .WH-WH		■ .OP	▲ .DA   .PU   .D1		◆		● ■ ▲ ◆ K51703.01.RF.XX.OP.ST.8.XX.XX						

DISC SQ	ref.	dimensions mm.	inst.	finish	optic options	power	CRI	K	eff. Lm/W	lumen max.	dim. opt.	tech. opt.	watt max.	mA	sketch	
	K51703	.02 172x172x22	.RF	●	■	.ST	.8	80	.30	83	1040	▲	◆	12	300	
									.40	85	1060					
			● ext-int finish .BK-BK   .WH-WH		■ .OP	▲ .DA   .PU   .D1   .PC		◆		● ■ ▲ ◆ K51703.02.RF.XX.OP.ST.8.XX.XX						

DISC SQ	ref.	dimensions mm.	inst.	finish	optic options	power	CRI	K	eff. Lm/W	lumen max.	dim. opt.	tech. opt.	watt max.	mA	sketch	
	K51703	.03 225x225x22	.RF	●	■	.ST	.8	80	.30	90	1750	▲	◆	20	500	
									.40	92	1800					
			● ext-int finish .BK-BK   .WH-WH		■ .OP	▲ .DA   .PU   .D1   .PC		◆		● ■ ▲ ◆ K51703.03.RF.XX.OP.ST.8.XX.XX						

DISC SQ	ref.	dimensions mm.	inst.	finish	optic options	power	CRI	K	eff. Lm/W	lumen max.	dim. opt.	tech. opt.	watt max.	mA	sketch	
	K51703	.04 300x300x22	.RF	●	■	.ST	.8	80	.30	98	2300	▲	◆	24	600	
									.40	100	2350					
			● ext-int finish .BK-BK   .WH-WH		■ .OP	▲ .DA   .PU   .D1   .PC		◆		● ■ ▲ ◆ K51703.04.RF.XX.OP.ST.8.XX.XX						



indoor  
RF



# disc slim

K51704

- ALUMINIUM
- IP20 / IP43
- IK03
- LIGHT DIRECTION FIXED
- DIM OPTIONAL
- REMOTE
- 0°
- INDOOR
- 220-240 V 50-60 Hz
- LIFE 50.000h
- WARRANTY 5 Years
- CE

Other installations / Otras instalaciones.

pag. 22 .SR

DISC SLIM	ref.	dimensions mm.	inst.	finish	optic options	power	CRI	K	eff. Lm/W	lumen max.	dimmm opt.	tech opt.	watt max.	mA	sketch	
	K51704	.01 Ø90x25	.RF	●	■	.ST	.8	80	.30	70	445	▲	●	6	160	
										.40	74					
			● ext-int finish .WH-WH		■ .OP	▲ .DA   .PU   .D1		K51704.01.RF.XX.OP.ST.8.XX.XX								

DISC SLIM	ref.	dimensions mm.	inst.	finish	optic options	power	CRI	K	eff. Lm/W	lumen max.	dimmm opt.	tech opt.	watt max.	mA	sketch	
	K51704	.02 Ø145x25	.RF	●	■	.ST	.8	80	.30	97	1210	▲	●	12	300	
										.40	97					
			● ext-int finish .WH-WH		■ .OP	▲ .DA   .PU   .D1   .PC		K51704.02.RF.XX.OP.ST.8.XX.XX								

DISC SLIM	ref.	dimensions mm.	inst.	finish	optic options	power	CRI	K	eff. Lm/W	lumen max.	dimmm opt.	tech opt.	watt max.	mA	sketch	
	K51704	.03 Ø225x25	.RF	●	■	.ST	.8	80	.30	95	2270	▲	●	24	600	
										.40	100					
			● ext-int finish .WH-WH		■ .OP	▲ .DA   .PU   .D1   .PC		K51704.03.RF.XX.OP.ST.8.XX.XX								



# disc slim sq

K51705

- ALUMINIUM
- IP20 / IP43
- IK03
- LIGHT DIRECTION FIXED
- DIM OPTIONAL
- REMOTE
- 0°
- INDOOR
- 220-240 V 50-60 Hz
- LIFE 50.000h
- WARRANTY 5 Years
- CE

Other installations / Otras instalaciones.

pag. 24 .SR

DISC SLIM SQ	ref.	dimensions mm.	inst.	finish	optic options	power	CRI	K	eff. Lm/W	lumen max.	dimmm opt.	tech opt.	watt max.	mA	sketch	
	K51705	.01 90x90x25	.RF	●	■	.ST	.8	80	.30	70	445	▲	●	6	160	
										.40	74					
			● ext-int finish .WH-WH		■ .OP	▲ .DA   .PU   .D1		K51705.01.RF.XX.OP.ST.8.XX.XX								

DISC SLIM SQ	ref.	dimensions mm.	inst.	finish	optic options	power	CRI	K	eff. Lm/W	lumen max.	dimmm opt.	tech opt.	watt max.	mA	sketch	
	K51705	.02 145x145x25	.RF	●	■	.ST	.8	80	.30	97	1210	▲	●	12	300	
										.40	97					
			● ext-int finish .WH-WH		■ .OP	▲ .DA   .PU   .D1   .PC		K51705.02.RF.XX.OP.ST.8.XX.XX								

DISC SLIM SQ	ref.	dimensions mm.	inst.	finish	optic options	power	CRI	K	eff. Lm/W	lumen max.	dimmm opt.	tech opt.	watt max.	mA	sketch	
	K51705	.03 225x225x25	.RF	●	■	.ST	.8	80	.30	95	2270	▲	●	24	600	
										.40	100					
			● ext-int finish .WH-WH		■ .OP	▲ .DA   .PU   .D1   .PC		K51705.03.RF.XX.OP.ST.8.XX.XX								

indoor  
RF

indoor

RF



# disc mini tiny

K50600

- ALUMINIUM
- IP20 / IP23
- IK06
- LIGHT DIRECTION FIXED
- NON DIMMABLE
- REMOTE
- 0°
- 0°
- INDOOR
- 220-240 V 50-60 Hz
- LIFE 50.000h
- WARRANTY 5 Years
- CE
- RoHS

indoor

RF



# disc mini tiny sq

K50601

- ALUMINIUM
- IP20 / IP23
- IK06
- LIGHT DIRECTION FIXED
- NON DIMMABLE
- REMOTE
- 0°
- 0°
- INDOOR
- 220-240 V 50-60 Hz
- LIFE 50.000h
- WARRANTY 5 Years
- CE
- RoHS

DISC MINI TINY	ref.	dimensions mm.	inst.	finish	optic options	power	CRI	K	eff. Lm/W	lumen max.	dim. opt.	tech. opt.	watt max.	mA	sketch
	<b>K50600</b>	<b>.01</b> Ø88x22	<b>.RF</b>	●	■	<b>.ST</b>	<b>.8</b> 80	<b>.40</b>	88	650	▲	◆	8	240	
				● ext-int finish <b>.WH-WH</b>	■ <b>.OP</b>		▲		◆				<b>K50600.01.RF.XX.OP.ST.8.XX</b>		

DISC MINI TINY SQ	ref.	dimensions mm.	inst.	finish	optic options	power	CRI	K	eff. Lm/W	lumen max.	dim. opt.	tech. opt.	watt max.	mA	sketch
	<b>K50601</b>	<b>.01</b> 88x88x22	<b>.RF</b>	●	■	<b>.ST</b>	<b>.8</b> 80	<b>.40</b>	88	650	▲	◆	8	240	
				● ext-int finish <b>.WH-WH</b>	■ <b>.OP</b>		▲		◆				<b>K50601.01.RF.XX.OP.ST.8.XX</b>		

indoor

RF

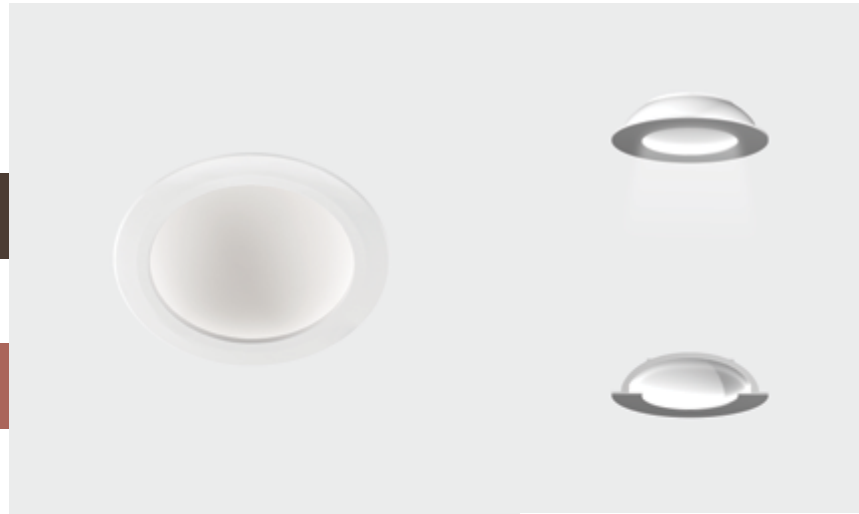

# disc tina deep

K50405

- ALUMINIUM
- IP20 / IP23
- IK08
- LIGHT DIRECTION FIXED
- NON DIMMABLE
- REMOTE
- 0°
- 0°
- INDOOR
- 220-240 V 50-60 Hz
- LIFE 50.000h
- WARRANTY 5 Years
- CE
- RoHS

DISC TINA DEEP	ref.	dimensions mm.	inst.	finish	optic options	power	CRI	K	eff. Lm/W	lumen max.	dimm opt.	tech opt.	watt max.	mA	sketch	
	K50405	.01 Ø105x35	.RF	●	■	.ST	.8	80	.30	60	500	▲	◆	8	300	
									.40	67	550					
				● ext-int finish .WH-WH		■	▲ .DA   .PU   .D1   .PC				◆		● K50405.01.RF.XX.ST.8.XX			

DISC TINA DEEP	ref.	dimensions mm.	inst.	finish	optic options	power	CRI	K	eff. Lm/W	lumen max.	dimm opt.	tech opt.	watt max.	mA	sketch	
	K50405	.02 Ø170x55	.RF	●	■	.ST	.8	80	.30	78	1300	▲	◆	18	400	
									.40	84	1390					
				● ext-int finish .WH-WH		■	▲ DA   .PU   .D1				◆		● K50405.02.RF.XX.ST.8.XX			

DISC TINA DEEP	ref.	dimensions mm.	inst.	finish	optic options	power	CRI	K	eff. Lm/W	lumen max.	dimm opt.	tech opt.	watt max.	mA	sketch	
	K50405	.03 Ø225x70	.RF	●	■	.ST	.8	80	.30	87	2000	▲	◆	24	600	
									.40	91	2100					
				● ext-int finish .WH-WH		■	▲ DA   .PU   .D1   .PC				◆		● K50405.03.RF.XX.ST.8.XX			





disc tina  
deep sq  
K50415

indoor

- ALUMINIUM
- IP20 / IP23
- IK06
- LIGHT DIRECTION FIXED
- NON DIMMABLE
- REMOTE
- 0°
- INDOOR
- 220-240 V 50-60 Hz
- WARRANTY 5 Years
- CE
- RF

DISC TINA DEEP SQ	ref.	dimensions mm.	inst.	finish	optic options	power	CRI	K	eff. Lm/W	lumen max.	dimm opt.	tech opt.	watt max.	mA	sketch	
	K50415	.01 111x111x35	.RF	●	■	.ST	.8	80	.30	60	500	▲	◆	8	300	
									.40	67	550					
		 98x98	 55 mm.	● ext-int finish .WH-WH		■	-	▲ .DA   .PU   .D1   .PC		◆	●		K50415.01.RF.XX.ST.8.X			

DISC TINA DEEP SQ	ref.	dimensions mm.	inst.	finish	optic options	power	CRI	K	eff. Lm/W	lumen max.	dimm opt.	tech opt.	watt max.	mA	sketch	
	K50415	.02 180x180x55	.RF	●	■	.ST	.8	80	.30	78	1300	▲	◆	18	400	
									.40	84	1390					
		 160x160	 55 mm.	● ext-int finish .WH-WH		■	-	▲ DA   .PU   .D1		◆	●		K50415.02.RF.XX.ST.8.X			



indoor

RF

CHESS K-SELECT	ref.	dimensions mm.	inst.	finish	optic options	power	CRI	■ K*1	eff. Lm/W	lumen max.	dimm opt.	tech opt.	watt max.	mA	sketch					
	<b>K50510</b>	<b>.01</b> 595x595x8	<b>.RF</b>	●	■	<b>.ST</b>	<b>.8</b>	80	■	87	3450	▲	◆	40	1000					
																	<b>MP</b>	<b>.30</b>	87	3450
																		<b>.40</b>	98	3850
																		<b>.60</b>	93	3650
																	<b>OP</b>	<b>.30</b>	91	3600
																		<b>.40</b>	101	4000
<b>.60</b>	96	3800																		
	595x595		20 mm.	● ext-int finish <b>.WH-WH</b>	■ <b>.MP   .OP   .SK*2</b>	▲ <b>.DA   .PU   .D1</b>	◆	● ■ ▲ <b>K50510.01.RF.XX.XX.ST.8.01.XX*3</b>												

CHESS K-SELECT	ref.	dimensions mm.	inst.	finish	optic options	power	CRI	■ K*1	eff. Lm/W	lumen max.	dimm opt.	tech opt.	watt max.	mA	sketch					
	<b>K50510</b>	<b>.02</b> 1195x295x8	<b>.RF</b>	●	■	<b>.ST</b>	<b>.8</b>	80	■	67	2300	▲	◆	36	900					
																	<b>MP</b>	<b>.30</b>	67	2300
																		<b>.40</b>	79	2700
																		<b>.60</b>	73	2500
																	<b>OP</b>	<b>.30</b>	74	2600
																		<b>.40</b>	87	3000
<b>.60</b>	81	2800																		
	1195x295		20 mm.	● ext-int finish <b>.WH-WH</b>	■ <b>.MP   .OP   .SK*2</b>	▲ <b>.DA   .PU   .D1</b>	◆	● ■ ▲ <b>K50510.02.RF.XX.XX.ST.8.01.XX*3</b>												

\*1 The luminaire includes three color temperatures (3000K-4000K-6000K), manually selectable before its installation by switch. / La luminaria incluye las tres temperaturas de color (3000K-4000K-6000K), seleccionables de forma manual antes de su instalación mediante switch.

\*2 The .SK (SKY) diffuser is for decorative purposes (non-measurable lumens). El difusor .SK (SKY) es para fines decorativos (lúmenes no medibles).

\*3 Kselect model is indicated by .01 in the nomenclature. / El modelo kselect, se indica con .01 en la nomenclatura.



▲

CHESS K-SELECT	ref.	dimensions mm.	inst.	finish	optic options	power	CRI	■ K*1	eff. Lm/W	lumen max.	dimm opt.	tech opt.	watt max.	mA	sketch					
	<b>K50510</b>	<b>.03</b> 1195x595x8	<b>.RF</b>	●	■	<b>.ST</b>	<b>.8</b>	80	■	73	4250	▲	◆	60	1500					
																	<b>MP</b>	<b>.30</b>	73	4250
																		<b>.40</b>	85	4950
																		<b>.60</b>	76	4450
																	<b>OP</b>	<b>.30</b>	76	4400
																		<b>.40</b>	87	5100
<b>.60</b>	79	4600																		
	1195x595		20 mm.	● ext-int finish <b>.WH-WH</b>	■ <b>.MP   .OP   .SK*2</b>	▲ <b>.DA   .PU   .D1</b>	◆	● ■ ▲ <b>K50510.03.RF.XX.XX.ST.8.01.XX*3</b>												

\*1 The luminaire includes three color temperatures (3000K-4000K-6000K), manually selectable before its installation by switch. / La luminaria incluye las tres temperaturas de color (3000K-4000K-6000K), seleccionables de forma manual antes de su instalación mediante switch.

\*2 The .SK (SKY) diffuser is for decorative purposes (non-measurable lumens). El difusor .SK (SKY) es para fines decorativos (lúmenes no medibles).

\*3 Kselect model is indicated by .01 in the nomenclature. / El modelo kselect, se indica con .01 en la nomenclatura.

# chess k-select

K50510

indoor

RF

- ALUMINIUM
- IP20  
IP23
- IK03
- LIGHT DIRECTION  
FIXED
- DIM  
OPTIONAL
- UGR  
≤ 19
- REMOTE
- 0°
- 0°
- INDOOR
- 220-240 V  
50-60 Hz
- LIFE  
50.000h
- WARRANTY  
5 Years
- CE
- RoHS



# chess de k-select

K50515

ALUMINIUM

IP20  
IP23

IK03

LIGHT DIRECTION  
FIXED

DIM  
OPTIONAL

UGR  
≤ 19

REMOTE

0°

0°

INDOOR

220-240 V  
50-60 Hz

RF

LIFE  
50.000h



WARRANTY  
5 Years

CE

WARRANTY  
5 Years

CE

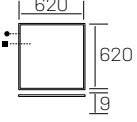
WARRANTY  
5 Years

CHESS DE K-SELECT	ref.	dimensions mm.	inst.	finish	optic options	power	CRI		■ K*1	eff. Lm/W	lumen max.	dimm opt.	tech opt.	watt max.	mA	sketch	
	<b>K50515</b>	<b>.01</b> 620x620x9	<b>.RF</b>	●	■	<b>.ST</b>	<b>.8</b>	80	<b>MP</b>	<b>.30</b>	87	3450	▲	◆	40	1000	
										<b>.40</b>	98	3850					
										<b>.60</b>	93	3650					
										<b>.30</b>	91	3600					
										<b>.40</b>	101	4000					
										<b>.60</b>	96	3800					
	620x620	 20 mm.	● ext-int finish <b>.WH-WH</b>	■ <b>.MP   .OP   .SK*2</b>	▲ <b>.DA   .PU   .D1</b>	◆ <b>K50515.01.RF.XX.XX.ST.8.01.XX*</b>											

\*1 The luminaire includes three color temperatures (3000K-4000K-6000K), manually selectable before its installation by switch. / La luminaria incluye las tres temperaturas de color (3000K-4000K-6000K), seleccionables de forma manual antes de su instalación mediante switch.

\*2 The .SK (SKY) diffuser is for decorative purposes (non-measurable lumens). El difusor .SK (SKY) es para fines decorativos (lúmenes no medibles).

\*3 K-select model is indicated by .01 in the nomenclature. / El modelo k-select, se indica con .01 en la nomenclatura.







The luminaire can be customised with the color chart options using code COLORCOST.DIMENSIONS.XX (e.g. COLORCOST.01.GY). Refer to 238 page. La luminaria se puede personalizar con las opciones de la carta de color usando el código COLORCOST.DIMENSIONS.XX (ej. COLORCOST.01.GY) Ver pag. 238.









# chess elite k-select



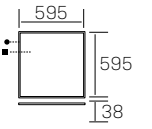



K50523

indoor

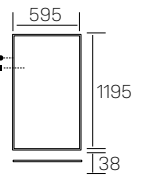
RF

- ALUMINIUM
- IP20 / IP23
- IK03
- LIGHT DIRECTION FIXED
- DIM OPTIONAL
- REMOTE
- 0°
- UGR ≤ 19
- INDOOR
- 220-240 V 50-60 Hz
- LIFE 50.000h
- WARRANTY 5 Years
- CE
- RoHS

CHESS ELITE K-SELECT	ref.	dimensions mm.	inst.	finish	optic options	power	CRI		■	K*1	eff. Lm/W	lumen max.	dimm opt.	tech opt.	watt max.	mA	sketch	
	<b>K50523</b>	<b>.01</b> 595x595x38	<b>.RF</b>	●	■	<b>.ST</b>	<b>.8</b>	80	■	<b>.30</b>	87	3450	▲	◆	40	1000		
											<b>.40</b>	98						3850
											<b>.60</b>	93						3650
											<b>.30</b>	91						3600
											<b>.40</b>	101						4000
											<b>.60</b>	96						3800
		 <b>.WH-WH</b>	 <b>.MP   .OP   .SK*2</b>	 <b>.DA   .PU   .D1</b>	 <b>K50523.01.RF.XX.XX.ST.8.01.XX*3</b>													

CHESS ELITE K-SELECT	ref.	dimensions mm.	inst.	finish	optic options	power	CRI		■	K*1	eff. Lm/W	lumen max.	dimm opt.	tech opt.	watt max.	mA	sketch	
	<b>K50523</b>	<b>.02</b> 1195x595x38	<b>.RF</b>	●	■	<b>.ST</b>	<b>.8</b>	80	■	<b>.30</b>	73	4250	▲	◆	60	1500		
											<b>.40</b>	85						4950
											<b>.60</b>	76						4450
											<b>.30</b>	76						4400
											<b>.40</b>	87						5100
											<b>.60</b>	79						4600
		 <b>.WH-WH</b>	 <b>.MP   .OP   .SK*2</b>	 <b>.DA   .PU   .D1</b>	 <b>K50523.02.RF.XX.XX.ST.8.01.XX*3</b>													

\*1 The luminaire includes three color temperatures (3000K-4000K-6000K), manually selectable before its installation by switch. / La luminaria incluye las tres temperaturas de color (3000K-4000K-6000K), seleccionables de forma manual antes de su instalación mediante switch.

\*2 The .SK (SKY) diffuser is for decorative purposes (non-measurable lumens). El difusor .SK (SKY) es para fines decorativos (lúmenes no medibles).

\*3 Kselect model is indicated by .01 in the nomenclature. / El modelo kselect, se indica con .01 en la nomenclatura.



The luminaire can be customised with the color chart options using code COLORCOST.DIMENSIONS.XX (e.g. COLORCOST.01.GY). Refer to 238 page. La luminaria se puede personalizar con las opciones de la carta de color usando el código COLORCOST.DIMENSIONS.XX (ej. COLORCOST.01.GY) Ver pag. 238.



# chess winner k-select

K50522

ALUMINIUM IP20 IP23 IK03 LIGHT DIRECTION FIXED DIM OPTIONAL

REMOTE 0° UGR ≤ 19 INDOOR 220-240 V 50-60 Hz

LIFE 50.000h WARRANTY 5 Years CE

indoor RF

CHESS WINNER K-SELECT	ref.	dimensions mm.	inst.	finish	optic options	power	CRI	■ K*1	eff. Lm/W	lumen max.	dimm opt.	tech opt.	watt max.	mA	sketch		
	<b>K50522</b>	<b>.01</b> 595x595x29	<b>.RF</b>	●	■	<b>.ST</b>	<b>.8</b>	80	<b>.30</b>	74	2700	▲	◆	37	1000		
									<b>MP</b>	<b>.40</b>	88						3200
									<b>.60</b>	80	2900						
									<b>OP</b>	<b>.30</b>	82						3000
									<b>.40</b>	96	3500						
									<b>.60</b>	80	3200						
595x595		20 mm.	● ext-int finish <b>.WH-WH</b>	■ <b>.MP   .OP   .SK*2</b>	▲ <b>.DA   .PU   .D1</b>	<b>K50522.01.RF.XX.XX.ST.8.01.XX*3</b>											

CHESS WINNER K-SELECT	ref.	dimensions mm.	inst.	finish	optic options	power	CRI	■ K*1	eff. Lm/W	lumen max.	dimm opt.	tech opt.	watt max.	mA	sketch		
	<b>K50522</b>	<b>.02</b> 1195x595x29	<b>.RF</b>	●	■	<b>.ST</b>	<b>.8</b>	80	<b>.30</b>	107	6000	▲	◆	60	1500		
									<b>MP</b>	<b>.40</b>	114						6400
									<b>.60</b>	110	6250						
									<b>OP</b>	<b>.30</b>	132						7400
									<b>.40</b>	140	7800						
									<b>.60</b>	136	7650						
1195x595		20 mm.	● ext-int finish <b>.WH-WH</b>	■ <b>.MP   .OP   .SK*2</b>	▲ <b>.DA   .PU   .D1</b>	<b>K50522.02.RF.XX.XX.ST.8.01.XX*3</b>											

\*1 The luminaire includes three color temperatures (3000K-4000K-6000K), manually selectable before its installation by switch. / La luminaria incluye las tres temperaturas de color (3000K-4000K-6000K), seleccionables de forma manual antes de su instalación mediante switch.

\*2 The SK (SKY) diffuser is for decorative purposes (non-measurable lumens). El difusor SK (SKY) es para fines decorativos (lúmenes no medibles).

\*3 K-select model is indicated by .01 in the nomenclature. / El modelo k-select, se indica con .01 en la nomenclatura.

\*4 The Luminaire has a frame which is visible and measures 2mm / La luminaria tiene un marco visible de 2mm.

# MOUNTING HARDWARE CHESS COLLECTION

## MONTAJE COLECCIÓN CHESS

Frame for trimless installation (TR):

Marco para instalación empotrado (TR): 

luminaire ref.	frame dimensions	frame ref.
K50510.01   K50522.01   K50523.01	595x595x55 mm.	KAC50510.01.TR
K50515.01	620x620x55 mm.	KAC50515.01.TR
K50510.02	1195x295x55 mm.	KAC50510.02.TR
K50510.03   K50522.02   K50523.02	1195x595x55 mm.	KAC50510.03.TR

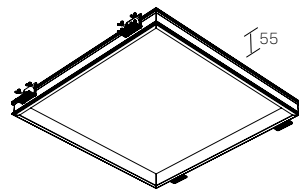

Frame for recessed with frame installation (RF):

Marco para instalación empotrado con marco (RF): 

luminaire ref.	frame dimensions	frame ref.
K50510.01   K50522.01   K50523.01	608x608x55 mm.	KAC50510.01.RF
K50515.01	633x633x55 mm.	KAC50515.01.RF
K50510.02	1208x308x55 mm.	KAC50510.02.RF
K50510.03   K50522.02   K50523.02	1208x608x55 mm.	KAC50510.03.RF

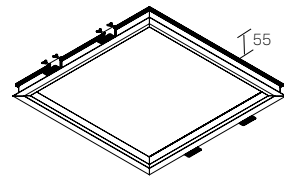

Clamps for recessed with frame installation (RF):

Pinzas para instalación empotrado con marco (RF):

luminaire ref.	units required	clamp ref.
K50510.01   K50522.01   K50523.01	4	KC50510.RF
K50515.01	4	KC50510.RF
K50510.02	6	KC50510.RF
K50510.03   K50522.02   K50523.02	6	KC50510.RF



Frame for surface installation (SR):

Marco para instalación superficie (SR): 

luminaire ref.	frame dimensions	frame ref.
K50510.01   K50522.01   K50523.01	595x595x50 mm.	KAC50510.01.SR
K50515.01	620x620x50 mm.	KAC50515.01.SR
K50510.02	1195x295x50 mm.	KAC50510.02.SR
K50510.03   K50522.02   K50523.02	1195x595x50 mm.	KAC50510.03.SR

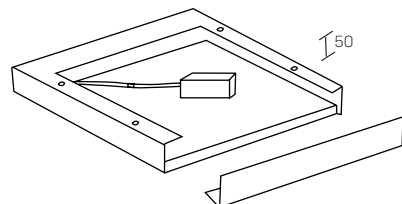

Cables for pendant installation (PN):

Cables para instalación colgante (PN):

luminaire ref.	cable dimensions	units required	cable ref.
K50510.01   K50522.01   K50523.01	max. 670 mm.	4	KAC50510.PN
K50515.01		4	KAC50510.PN
K50510.02		6	KAC50510.PN
K50510.03   K50522.02   K50523.02		6	KAC50510.PN

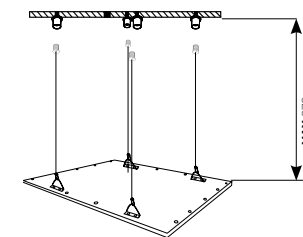

Accesorios are delivered separately (not installed in luminaire) / Los accesorios se sirven por separado (no instalados en la luminaria).

 The luminaire can be customised with the color chart options using code COLORCOST.DIMENSIONS.XX (e.g. COLORCOST.01.GY). Refer to 238 page.  
La luminaria se puede personalizar con las opciones de la carta de color usando el código COLORCOST.DIMENSIONS.XX (ej. COLORCOST.01.GY) Ver pag. 238.

indoor

RF



# moon

K50110

- ALUMINIUM
- IP20 / IP23
- IK05
- LIGHT DIRECTION FIXED
- NON DIMMABLE
- GU10
- 0°
- HONEYCOMB
- INDOOR
- 110-240 V 50-60 Hz
- LIFE 50.000h
- WARRANTY 5 Years
- CE

GU Lamps / Lámparas GU.

pag. 233 **GU**

indoor

RF



# moon daisy

K50132

- ALUMINIUM
- IP20 / IP23
- IK05
- LIGHT DIRECTION ADJUSTABLE
- NON DIMMABLE
- GU10
- 15°
- HONEYCOMB
- INDOOR
- 110-240 V 50-60 Hz
- LIFE 50.000h
- WARRANTY 5 Years
- CE

GU Lamps / Lámparas GU.

pag. 233 **GU**

MOON	ref.	dimensions mm.	inst.	finish	optic options	power	CRI	K	eff. Lm/W	lumen max.	dimmm opt.	tech opt.	watt max.	mA	sketch
	<b>K50110</b>	<b>.01</b> Ø85x40 (105)*	<b>.RF</b>	●	■	-	-	-	-	-	▲	◆	8W LED	-	
			● ext-int finish <b>.BK-BK   .WH-WH</b>		■	▲		◆	<b>K50110.01.RF.XX.GU</b>						
	75 mm.	20 mm.													

\* Luminaire's total height includes lamp and lamp holder. / La altura total de la luminaria incluye la bombilla y el portalámpara.

MOON DAISY	ref.	dimensions mm.	inst.	finish	optic options	power	CRI	K	eff. Lm/W	lumen max.	dimmm opt.	tech opt.	watt max.	mA	sketch
	<b>K50132</b>	<b>.01</b> Ø83x50 (114)*	<b>.RF</b>	●	■	-	-	-	-	-	▲	◆	8W LED	-	
			● ext-int finish <b>.BK-BK   .WH-WH</b>		■	▲		◆	<b>K50132.01.RF.XX.GU</b>						
	76 mm.	20 mm.													

\* Luminaire's total height includes lamp and lamp holder. / La altura total de la luminaria incluye la bombilla y el portalámpara.



# ozone

K50112

indoor

- ALUMINIUM
- IP20 / IP23
- IK05
- LIGHT DIRECTION ADJUSTABLE
- NON DIMMABLE
- GU10
- 30°
- HONEYCOMB
- INDOOR
- 110-240 V 50-60 Hz
- LIFE 50.000h
- WARRANTY 5 Years
- CE
- RF

GU Lamps / Lámparas GU.

pag. 233 **GU**

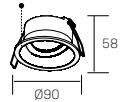
OZONE	ref.	dimensions mm.	inst.	finish	optic options	power	CRI	K	eff. Lm/W	lumen max.	dimm opt.	tech opt.	watt max.	mA	sketch
	<b>K50112</b>	<b>.01</b> Ø90x58 (130)*	<b>.RF</b>	●	■	-	-	-	-	-	▲	◆	8W LED	-	
		80 mm.	20 mm.	● ext-int finish <b>.BK-BK   .WH-WH</b>	■ <b>.GU</b>										<b>K50112.01.RF.XX.GU</b>

\* Luminaire's total height includes lamp and lamp holder. / La altura total de la luminaria incluye la bombilla y el portalámpara.

indoor

RF



sun  
K50140

- ALUMINIUM
- IP20 / IP23
- IK05
- LIGHT DIRECTION FIXED
- NON DIMMABLE
- 0°
- HONEYCOMB
- INDOOR
- 110-240 V 50-60 Hz
- LIFE 50.000h
- WARRANTY 5 Years
- CE
- RoHS

GU Lamps / Lámparas GU.

pag. 233 **GU**

indoor

RF



sun dawn  
K50141

- ALUMINIUM
- IP20 / IP23
- IK05
- LIGHT DIRECTION FIXED
- NON DIMMABLE
- 0°
- HONEYCOMB
- INDOOR
- 110-240 V 50-60 Hz
- LIFE 50.000h
- WARRANTY 5 Years
- CE
- RoHS

GU Lamps / Lámparas GU.

pag. 233 **GU**

SUN	ref.	dimensions mm.	inst.	finish	optic options	power	CRI	K	eff. Lm/W	lumen max.	dimmm opt.	tech opt.	watt max.	mA	sketch
	<b>K50140</b>	<b>.01</b> Ø75x44 (100)*	<b>.RF</b>	●	■	-	-	-	-	-	▲	◆	8W LED	-	
	65mm.		20 mm.	● ext-int finish <b>.BK-BK   .WH-WH</b>		■ <b>.GU</b>		▲	◆	● ■ <b>K50140.01.RF.XX.GU</b>					

\* Luminaire's total height includes lamp and lamp holder. / La altura total de la luminaria incluye la bombilla y el portalámpara.

SUN DAWN	ref.	dimensions mm.	inst.	finish	optic options	power	CRI	K	eff. Lm/W	lumen max.	dimmm opt.	tech opt.	watt max.	mA	sketch
	<b>K50141</b>	<b>.01</b> Ø75x45 (100)*	<b>.RF</b>	●	■	-	-	-	-	-	▲	◆	8W LED	-	
	65mm.		20 mm.	● ext-int finish <b>.BK-BK   .WH-WH</b>		■ <b>.GU</b>		▲	◆	● ■ <b>K50141.01.RF.XX.GU</b>					

\* Luminaire's total height includes lamp and lamp holder. / La altura total de la luminaria incluye la bombilla y el portalámpara.

indoor

RF

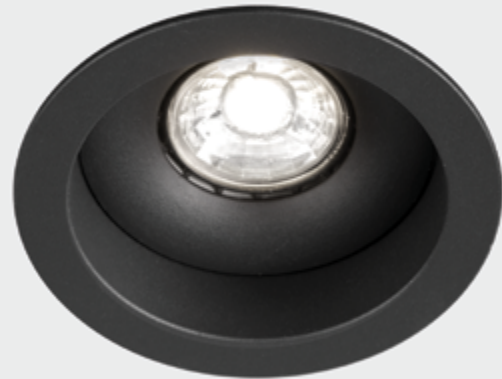

# venus

K50111

- ALUMINIUM
- IP20 / IP23
- IK05
- LIGHT DIRECTION ADJUSTABLE
- NON DIMMABLE
- GU10
- 30°
- 0°
- INDOOR
- 110-240 V 50-60 Hz
- LIFE 50.000h
- WARRANTY 5 Years
- CE

GU Lamps / Lámparas GU.

pag. 233 **GU**

indoor

RF



# venus dash

K50131

- ALUMINIUM
- IP20 / IP23
- IK05
- LIGHT DIRECTION ADJUSTABLE
- NON DIMMABLE
- GU10
- 30°
- HONEYCOMB
- INDOOR
- 110-240 V 50-60 Hz
- LIFE 50.000h
- WARRANTY 5 Years
- CE

GU Lamps / Lámparas GU.

pag. 233 **GU**

VENUS	ref.	dimensions mm.	inst.	finish	optic options	power	CRI	K	eff. Lm/W	lumen max.	dimm opt.	tech opt.	watt max.	mA	sketch
	<b>K50111</b>	<b>.01</b> Ø92x37 (103)*	<b>.RF</b>	●	■	-	-	-	-	-	▲	◆	8W LED	-	
		⌀ 80 mm.	H 20 mm.	● ext-int finish <b>.BK-BK   .WH-WH</b>	■ <b>.GU</b>			▲ -			◆ -				<b>K50111.01.RF.XX.GU</b>

\* Luminaire's total height includes lamp and lamp holder. / La altura total de la luminaria incluye la bombilla y el portalámpara.

VENUS DASH	ref.	dimensions mm.	inst.	finish	optic options	power	CRI	K	eff. Lm/W	lumen max.	dimm opt.	tech opt.	watt max.	mA	sketch
	<b>K50131</b>	<b>.01</b> Ø80x35 (100)*	<b>.RF</b>	●	■	-	-	-	-	-	▲	◆	8W LED	-	
		⌀ 70 mm.	H 20 mm.	● ext-int finish <b>.BK-BK   .WH-BK</b>	■ <b>.GU</b>			▲ -			◆ -				<b>K50131.01.RF.XX.GU</b>

\* Luminaire's total height includes lamp and lamp holder. / La altura total de la luminaria incluye la bombilla y el portalámpara.

indoor

RF



# venus dip IP65

K50113

- ALUMINIUM
- IP20  
IP65
- IK05
- LIGHT DIRECTION  
FIXED
- NON DIMMABLE
- GU10
- 0°
- HONEYCOMB
- INDOOR  
OUTDOOR
- 110-240 V  
50-60 Hz
- LIFE 50.000h
- WARRANTY 5 Years
- CE

GU Lamps / Lámparas GU.

pag. 233 **GU**

indoor

RF



# venus dot

K50130

- ALUMINIUM
- IP20  
IP23
- IK05
- LIGHT DIRECTION  
FIXED
- NON DIMMABLE
- GU10
- 0°
- HONEYCOMB
- INDOOR
- 110-240 V  
50-60 Hz
- LIFE 50.000h
- WARRANTY 5 Years
- CE

GU Lamps / Lámparas GU.

pag. 233 **GU**

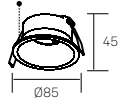
VENUS DIP IP65	ref.	dimensions mm.	inst.	finish	optic options	power	CRI	K	eff. Lm/W	lumen max.	dimm opt.	tech opt.	watt max.	mA	sketch
	<b>K50113</b>	<b>.01</b> Ø85x45 (108)*	<b>.RF</b>	●	■	-	-	-	-	-	▲	◆	8W LED	-	
⌀ 72 mm.	H 20 mm.	● ext-int finish <b>.BK-BK   .WH-WH</b>	■ <b>.GU</b>	▲ -	◆ -	<b>K50113.01.RF.XX.GU</b>			● ■ -						

\* Luminaire's total height includes lamp and lamp holder. / La altura total de la luminaria incluye la bombilla y el portalámpara.

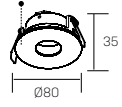
VENUS DOT	ref.	dimensions mm.	inst.	finish	optic options	power	CRI	K	eff. Lm/W	lumen max.	dimm opt.	tech opt.	watt max.	mA	sketch
	<b>K50130</b>	<b>.01</b> Ø80x35 (95)*	<b>.RF</b>	●	■	-	-	-	-	-	▲	◆	8W LED	-	
⌀ 70 mm.	H 20 mm.	● ext-int finish <b>.BK-BK   .WH-BK</b>	■ <b>.GU</b>	▲ -	◆ -	<b>K50130.01.RF.XX.GU</b>			● ■ -						

\* Luminaire's total height includes lamp and lamp holder. / La altura total de la luminaria incluye la bombilla y el portalámpara.



# WALL SURFACE

WS

indoor

WS



# marvin

K50707

- ALUMINIUM
- IP20
- IK05
- LIGHT DIRECTION FIXED
- NON DIMMABLE
- INTEGRATED
- 0°
- 0°
- INDOOR
- 220-240 V 50-60 Hz
- LIFE 50.000h
- WARRANTY 5 Years
- CE
- RoHS

MARVIN	ref.	dimensions mm.	inst.	finish	optic options	power	CRI	K	eff. Lm/W*	lumen max.*	dim opt.	tech opt.	watt max.	mA	sketch
	<b>K50707</b>	<b>.01</b> Ø180x42	<b>.WS</b>	●	■	<b>.ST</b>	<b>.8</b> 80	<b>.30</b>	80	860	▲	◆	12	300	
				● ext-int finish <b>.BK-BK   .WH-WH</b>				■			▲	◆	<b>K50707.01.WS.XX.ST.8.30</b>		

\* Please might expect a max. 15% value reduction in finishes other than white. / Puede haber una reducción máx. del 15% en el dato de los acabados distintos al blanco.



indoor

WS



# kubiq

K50708

- ALUMINIUM
- IP20
- IK05
- LIGHT DIRECTION FIXED
- NON DIMMABLE
- INTEGRATED
- 0°
- 0°
- INDOOR
- 220-240 V 50-60 Hz
- LIFE 50.000h
- WARRANTY 5 Years
- CE
- Recycling symbol

K UBIQ	ref.	dimensions mm.	inst.	finish	optic options	power	CRI	K	eff. Lm/W	lumen max.	dimm opt.	tech opt.	watt max.	mA	sketch	
	<b>K50708</b>	<b>.01</b> 100x100x100	<b>.WS</b>	●	■	<b>.ST</b>	<b>.9</b>	90	<b>.30</b>	77	615	▲	◆	8	180	
									<b>.40</b>	87	685					
				● ext-int finish <b>.WH-WH</b>				■			▲	◆			● <b>K50708.01.WS.XX.ST.9.XX</b>	





**serena**  
K50709

indoor

- ALUMINIUM
- IP32
- K05
- LIGHT DIRECTION FIXED
- NON DIMMABLE
- INTEGRATED
- 0°
- 0°
- INDOOR
- 220-240 V 50-60 Hz
- LIFE 50.000h
- WARRANTY 5 Years
- CE
- W

SERENA	ref.	dimensions mm.	inst.	finish	optic options	power	CRI	K	eff. Lm/W	lumen max.	dimm opt.	tech opt.	watt max.	mA	sketch
	<b>K50709</b>	<b>.01</b> 150x100x100	<b>.WS</b>	●	■	<b>.ST</b>	<b>.8</b> 80	<b>.30</b>	64	365	▲	◆	5	300	
				● ext-int finish <b>.WH-WH</b>				■			▲	◆	<b>K50709.01.WS.XX.ST.8.X</b>		

SERENA	ref.	dimensions mm.	inst.	finish	optic options	power	CRI	K	eff. Lm/W	lumen max.	dimm opt.	tech opt.	watt max.	mA	sketch
	<b>K50709</b>	<b>.02</b> 250x100x100	<b>.WS</b>	●	■	<b>.ST</b>	<b>.8</b> 80	<b>.30</b>	74	840	▲	◆	10	300	
				● ext-int finish <b>.WH-WH</b>				■			▲	◆	<b>K50709.02.WS.XX.ST.8.X</b>		

SERENA	ref.	dimensions mm.	inst.	finish	optic options	power	CRI	K	eff. Lm/W	lumen max.	dimm opt.	tech opt.	watt max.	mA	sketch
	<b>K50709</b>	<b>.03</b> 350x100x100	<b>.WS</b>	●	■	<b>.ST</b>	<b>.8</b> 80	<b>.30</b>	83	1250	▲	◆	15	300	
				● ext-int finish <b>.WH-WH</b>				■			▲	◆	<b>K50709.03.WS.XX.ST.8.X</b>		

indoor

WS



# sasha

K50710

- ALUMINIUM
- IP32
- IK05
- LIGHT DIRECTION FIXED
- NON DIMMABLE
- INTEGRATED
- 0°
- 0°
- INDOOR
- 220-240 V 50-60 Hz
- LIFE 50.000h
- WARRANTY 5 Years
- CE
- RoHS

SASHA	ref.	dimensions mm.	inst.	finish	optic options	power	CRI	K	eff. Lm/W*	lumen max.*	dimm opt.	tech opt.	watt max.	mA	sketch	
	K50710	.01 150x100x60	.WS	●	■	.ST	.9	90	.30	64	365	▲	◆	5	300	
				● ext-int finish .BK-BK   .WH-WH				■			▲	◆	K50710.01.WS.XX.ST.9.30			

SASHA	ref.	dimensions mm.	inst.	finish	optic options	power	CRI	K	eff. Lm/W*	lumen max.*	dimm opt.	tech opt.	watt max.	mA	sketch	
	K50710	.02 250x100x60	.WS	●	■	.ST	.9	90	.30	74	840	▲	◆	10	300	
				● ext-int finish .BK-BK   .WH-WH				■			▲	◆	K50710.02.WS.XX.ST.9.30			

SASHA	ref.	dimensions mm.	inst.	finish	optic options	power	CRI	K	eff. Lm/W*	lumen max.*	dimm opt.	tech opt.	watt max.	mA	sketch	
	K50710	.03 350x100x60	.WS	●	■	.ST	.9	90	.30	83	1250	▲	◆	15	300	
				● ext-int finish .BK-BK   .WH-WH				■			▲	◆	K50710.03.WS.XX.ST.9.30			

\* Please might expect a max. 15% value reduction in finishes other than white. / Puede haber una reducción máx. del 15% en el dato de los acabados distintos al blanco.



▲



**meso**  
K50706

indoor

- ALUMINIUM
- IP44
- IK05
- LIGHT DIRECTION FIXED
- NON DIMMABLE
- INTEGRATED
- 0°
- 0°
- INDOOR
- 220-240 V 50-60 Hz
- LIFE 50.000h
- WARRANTY 5 Years
- CE
- WS

MESO	ref.	dimensions mm.	inst.	finish	optic options	power	CRI	K	eff. Lm/W*	lumen max.*	dimm opt.	tech opt.	watt max.	mA	sketch	
	<b>K50706</b>	<b>.01</b> 110x66x245	<b>.WS</b>	●	■	<b>.ST</b>	<b>.9</b>	90	<b>.30</b>	72	590	▲	◆	10	500	
				● ext-int finish <b>.BK-BK   .WH-WH</b>				■		▲	◆		<b>K50706.01.WS.XX.ST.9.30</b>			

\* Please might expect a max. 15% value reduction in finishes other than white. / Puede haber una reducción máx. del 15% en el dato de los acabados distintos al blanco.

indoor

WS

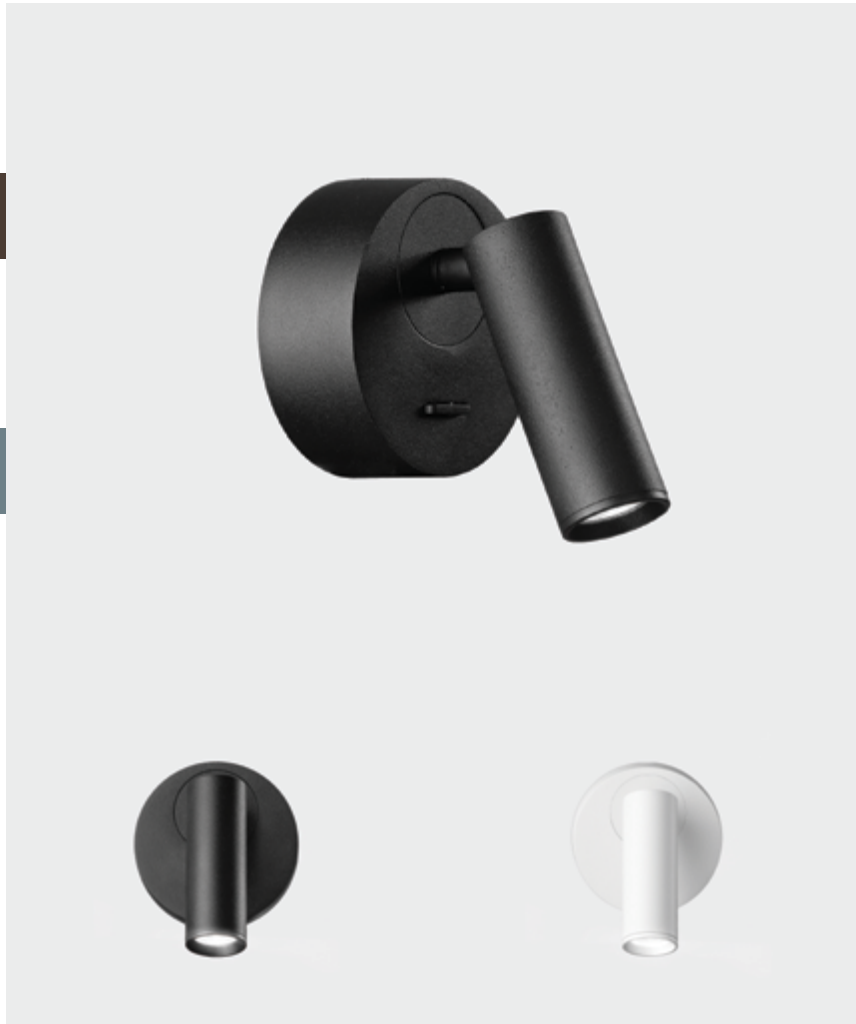

# myni

K50704

- ALUMINIUM
- IP20
- IK10
- LIGHT DIRECTION ADJUSTABLE
- NON DIMMABLE
- INTEGRATED
- 90°
- 360°
- INDOOR
- 220-240 V 50-60 Hz
- LIFE 50.000h
- WARRANTY 5 Years
- CE
- RoHS

MYNI	ref.	dimensions mm.	inst.	finish	optic options	power	CRI	K	eff. Lm/W*	lumen max.*	dimm opt.	tech opt.	watt max.	mA	sketch	
	<b>K50704</b>	<b>.01</b> Ø70x62x85	<b>.WS</b>	●	■	<b>.ST</b>	<b>.8</b>	80	<b>.30</b>	55	165	▲	◆	3	650	
				● ext-int finish <b>.BK-BK   .WH-WH</b>				■			▲	◆	<b>K50704.01.WS.XX.ST.8.30</b>			

\* Please might expect a max. 15% value reduction in finishes other than white. / Puede haber una reducción máx. del 15% en el dato de los acabados distintos al blanco.

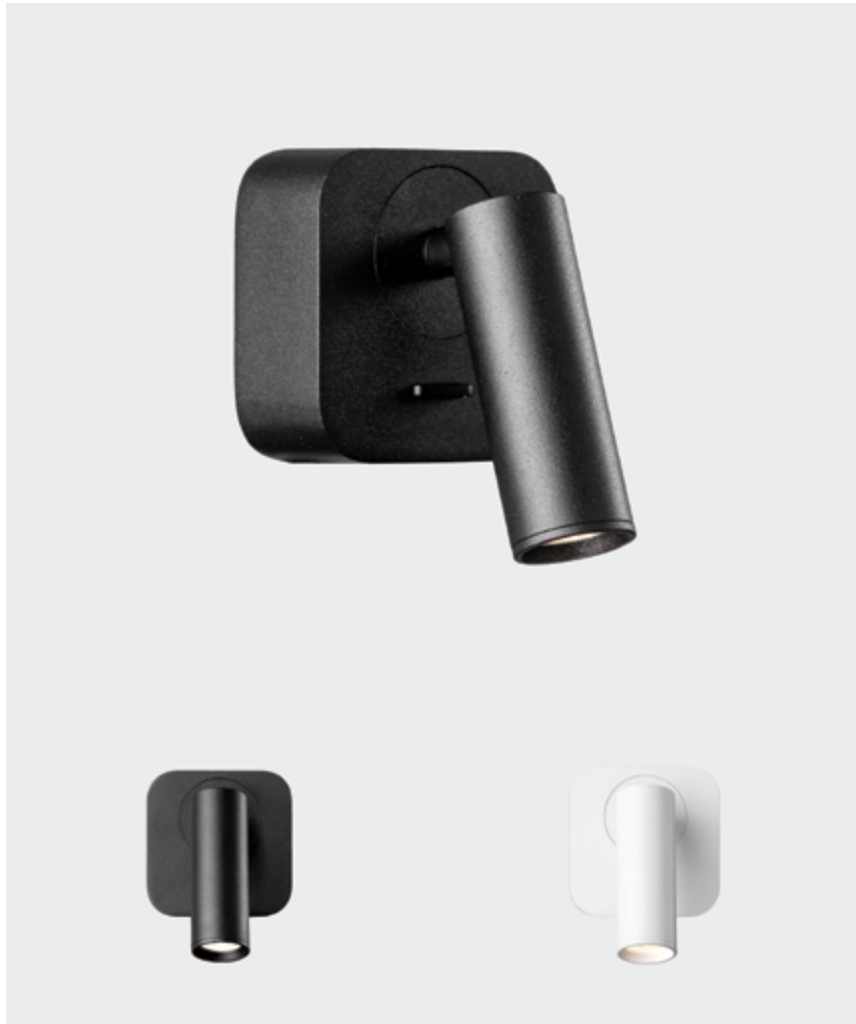

# myni sq

K50705

- ALUMINIUM
- IP20
- IK10
- LIGHT DIRECTION ADJUSTABLE
- NON DIMMABLE
- INTEGRATED
- 90°
- 360°
- INDOOR
- 220-240 V 50-60 Hz
- LIFE 50.000h
- WARRANTY 5 Years
- CE
- RoHS

indoor

WS

MYNI SQ	ref.	dimensions mm.	inst.	finish	optic options	power	CRI	K	eff. Lm/W*	lumen max.*	dimm opt.	tech opt.	watt max.	mA	sketch	
	<b>K50705</b>	<b>.01</b> 65x62x85	<b>.WS</b>	●	■	<b>.ST</b>	<b>.8</b>	80	<b>.30</b>	49	165	▲	◆	3	650	
				● ext-int finish <b>.BK-BK   .WH-WH</b>				■			▲	◆	<b>K50705.01.WS.XX.ST.8.30</b>			

\* Please might expect a max. 15% value reduction in finishes other than white. / Puede haber una reducción máx. del 15% en el dato de los acabados distintos al blanco.





indoor

WS



# sign

K50702

- ALUMINIUM
- IP20
- IK10
- LIGHT DIRECTION ADJUSTABLE
- NON DIMMABLE
- INTEGRATED
- 90°
- 360°
- INDOOR
- 220-240 V 50-60 Hz
- WARRANTY 5 Years
- LIFE 50.000h
- CE

Other installations / Otras instalaciones.

pag. 145 .WR

SIGN	ref.	dimensions mm.	inst.	finish	optic options	power	CRI	K	eff. Lm/W*	lumen max.*	dimmm opt.	tech opt.	watt max.	mA	sketch	
	<b>K50702</b>	.01 70x30x185	.WS	●	■	.ST	.8	80	.30	49	160	▲	◆	3	650	
				● ext-int finish .BK-BK   .WH-WH		■		▲		◆		●				<b>K50702.01.WS.XX.ST.8.30</b>

\* Please might expect a max. 15% value reduction in finishes other than white. / Puede haber una reducción máx. del 15% en el dato de los acabados distintos al blanco.

indoor

WS



# pixy

K50703

- ALUMINIUM
- IP20
- IK10
- LIGHT DIRECTION ADJUSTABLE
- NON DIMMABLE
- INTEGRATED
- 90°
- 180°
- INDOOR
- 220-240 V 50-60 Hz
- WARRANTY 5 Years
- LIFE 50.000h
- CE

PIXY	ref.	dimensions mm.	inst.	finish	optic options	power	CRI	K	eff. Lm/W	lumen max.	dimmm opt.	tech opt.	watt max.	mA	sketch	
	<b>K50703</b>	.01 120x70x390	.WS	●	■	.ST	.8	80	.30	70	700	▲	◆	7 + 3	650 + 300	
				● ext-int finish .BK-BK   .WH-WH		■		▲		◆		●				<b>K50703.01.WS.XX.ST.8.30</b>



indoor

WS



# bot

K50701

- ALUMINIUM
- IP20
- IK10
- LIGHT DIRECTION ADJUSTABLE
- NON DIMMABLE
- INTEGRATED
- 0°
- 360°
- INDOOR
- 220-240 V 50-60 Hz
- LIFE 50.000h
- WARRANTY 5 Years
- CE
- Recycling symbol

BOT	ref.	dimensions mm.	inst.	finish	optic options	power	CRI	K	eff. Lm/W	lumen max.	dimmt opt.	tech opt.	watt max.	mA	sketch
	<b>K50701</b>	<b>.01</b> Ø117x125	<b>.WS</b>	●	■	<b>.ST</b>	<b>.8</b> 80	<b>.30</b>	47	300	▲	◆	6	300	
				● ext-int finish <b>.BK-BK   .WH-WH</b>				■			▲	◆	<b>K50701.01.WS.XX.ST.8.30</b>		



# wally

K50700

- ALUMINIUM
- IP20
- IK10
- LIGHT DIRECTION ADJUSTABLE
- NON DIMMABLE
- INTEGRATED
- 45°
- 360°
- INDOOR
- 220-240 V 50-60 Hz
- LIFE 50.000h
- WARRANTY 5 Years
- CE
- Recycling symbol

indoor

WS

WALLY	ref.	dimensions mm.	inst.	finish	optic options	power	CRI	K	eff. Lm/W*	lumen max.*	dimmt opt.	tech opt.	watt max.	mA	sketch
	<b>K50700</b>	<b>.01</b> 120x80x95	<b>.WS</b>	●	■	<b>.ST</b>	<b>.8</b> 80	<b>.30</b>	50	325	▲	◆	6	300	
				● ext-int finish <b>.BK-BK   .WH-WH</b>				■			▲	◆	<b>K50700.01.WS.XX.ST.8.30</b>		

\* Please might expect a max. 15% value reduction in finishes other than white. / Puede haber una reducción máx. del 15% en el dato de los acabados distintos al blanco.

TRIMLESS



indoor

TR

indoor



Other installations / Otras instalaciones.

pag. 18 **.SR**  
 pag. 42 **.RF**  
 pag. 157 **.TK**

nseS  
K51300

- ALUMINIUM
- IP20  
IP23
- IK06
- LIGHT DIRECTION  
FIXED
- DIM  
OPTIONAL
- REMOTE
- 0°
- 0°
- INDOOR
- 220-240 V  
50-60 Hz
- LIFE  
50.000h
- WARRANTY  
5 Years
- CE
- RoHS

TR

NSES	ref.	dimensions mm.	inst.	finish	optic options	power	CRI	K	eff. Lm/W	lumen max.	dimmm opt.	tech opt.	watt max.	mA	sketch	
	<b>K51300</b>	<b>.01</b> 95x35x56.5	<b>.TR</b>	●	■	<b>.ST</b>	<b>.9</b>	90	<b>.27</b>	69	480	▲	◆	6	700	
									<b>.30</b>	74	520					
									<b>.40</b>	80	560					
		100x70mm.	20 mm.	● ext-int finish <b>.BK-BK-BK   .WH-BK-BK</b>				■	<b>.15   .30   .45</b>		▲		◆	<b>.DA   .PU</b>		● ■ ▲ <b>K51300.01.TR.XX.XX.ST.9.XX.XX</b>

NSES	ref.	dimensions mm.	inst.	finish	optic options	power	CRI	K	eff. Lm/W	lumen max.	dimmm opt.	tech opt.	watt max.	mA	sketch	
	<b>K51300</b>	<b>.02</b> 137x35x56.5	<b>.TR</b>	●	■	<b>.ST</b>	<b>.9</b>	90	<b>.27</b>	70	835	▲	◆	10	700	
									<b>.30</b>	73	875					
									<b>.40</b>	76	915					
		143x70 mm.	20 mm.	● ext-int finish <b>.BK-BK-BK   .WH-BK-BK</b>				■	<b>.15   .30   .45</b>		▲		◆	<b>.DA   .PU   .D1</b>		● ■ ▲ <b>K51300.02.TR.XX.XX.ST.9.XX.XX</b>

NSES	ref.	dimensions mm.	inst.	finish	optic options	power	CRI	K	eff. Lm/W	lumen max.	dimmm opt.	tech opt.	watt max.	mA	sketch	
	<b>K51300</b>	<b>.03</b> 270x35x56.5	<b>.TR</b>	●	■	<b>.ST</b>	<b>.9</b>	90	<b>.27</b>	68	1430	▲	◆	20	600	
									<b>.30</b>	73	1530					
									<b>.40</b>	78	1630					
		275x70 mm.	20 mm.	● ext-int finish <b>.BK-BK-BK   .WH-BK-BK</b>				■	<b>.15   .30   .45</b>		▲		◆	<b>.DA   .PU   .D1   .PC</b>		● ■ ▲ <b>K51300.03.TR.XX.XX.ST.9.XX.XX</b>



indoor



TR

# ozone sat

K50126

- ALUMINIUM
- IP20 / IP23
- IK05
- LIGHT DIRECTION FIXED
- NON DIMMABLE
- GU10
- 0°
- 0°
- INDOOR
- 110-240 V 50-60 Hz
- LIFE 50.000h
- WARRANTY 5 Years
- CE

GU Lamps / Lámparas GU

pag. 233 **GU**



OZONE SAT	ref.	dimensions mm.	inst.	finish	optic options	power	CRI	K	eff. Lm/W	lumen max.	dimm opt.	tech opt.	watt max.	mA	sketch
	<b>K50126</b>	<b>.01</b> Ø85x56 (125)*	<b>.TR</b>	●	■	-	-	-	-	-	▲	◆	8W LED	-	
				● ext-int finish <b>.BK-BK   .WH-WH</b>	■							◆			<b>K50126.01.TR.XX.GU</b>

\* Luminaire's total height includes lamp and lamp holder. / La altura total de la luminaria incluye la bombilla y el portalámpara.



# ozone sat sq

K50125

indoor

- ALUMINIUM
- IP20  
IP23
- IK05
- LIGHT DIRECTION  
FIXED
- NON DIMMABLE
- GU10
- 0°
- 0°
- INDOOR
- 110-240 V  
50-60 Hz
- LIFE 50.000h
- WARRANTY 5 Years
- CE
- RoHS

GU Lamps / Lámparas GU

pag. 233 **GU**

TR

OZONE SAT SQ	ref.	dimensions mm.	inst.	finish	optic options	power	CRI	K	eff. Lm/W	lumen max.	dimm opt.	tech opt.	watt max.	mA	sketch
	<b>K50125</b>	<b>.01</b> 78x78x50 (128)*	<b>.TR</b>	●	■	-	-	-	-	-	▲	◆	8W LED	-	
		88x88 mm.	20 mm.	● ext-int finish <b>.BK-BK   .WH-WH</b>	■ <b>.GU</b>						▲	◆			<b>K50125.01.TR.XX.GU</b>

\* Luminaire's total height includes lamp and lamp holder. / La altura total de la luminaria incluye la bombilla y el portalámpara.

WALL  
RECESSED

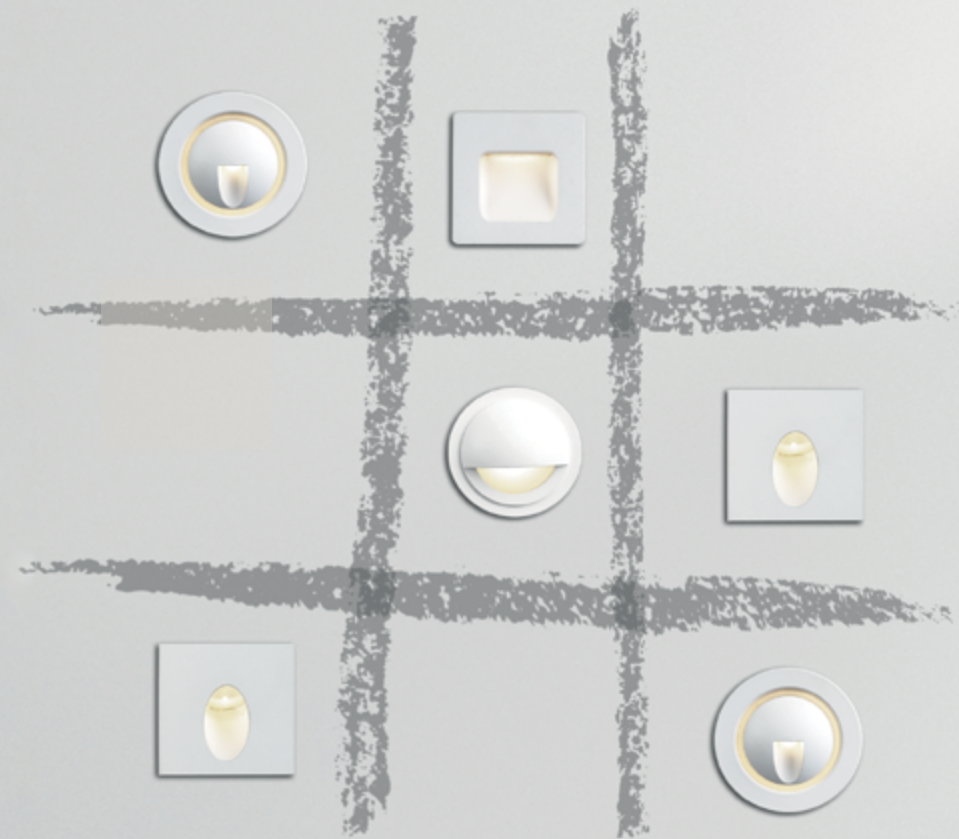



indoor



turma

K51207



WR

kora

K51206



indoor

WR

TURMA	ref.	dimensions mm.	inst.	finish	optic options	power	CRI	K	eff. Lm/W <sup>*1</sup>	lumen max. <sup>*1</sup>	dimm opt.	tech opt.	watt max.	mA	sketch
	<b>K51207</b>	<b>.01</b> Ø56x77,5	<b>.WR</b>	●	■	<b>.ST</b>	<b>.8</b>	80	<b>.30</b>	65	▲	◆	3	600	
		Ø55x65mm.		● ext-int finish <b>.WH-WH</b>	■				▲	◆	<b>K51207.01.WR.XX.ST.8.30</b>				

<sup>\*1</sup> Real values / Valores reales. <sup>\*2</sup> Product contains a splice box / El producto contiene caja de conexión.

KORA	ref.	dimensions mm.	inst.	finish	optic options	power	CRI	K	eff. Lm/W <sup>*1</sup>	lumen max. <sup>*1</sup>	dimm opt.	tech opt.	watt max.	mA	sketch
	<b>K51206</b>	<b>.01</b> Ø75x76	<b>.WR</b>	●	■	<b>.ST</b>	<b>.8</b>	80	<b>.30</b>	65	▲	◆	1 +	300	
		Ø66x65 mm.		● ext-int finish <b>.WH-WH</b>	■				▲	◆	<b>K51206.01.WR.XX.ST.8.30</b>				

<sup>\*1</sup> Real values / Valores reales. <sup>\*2</sup> Product contains a splice box / El producto contiene caja de conexión.

indoor



rubix

K51205



WR

indoor



sign



K50702



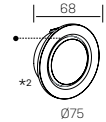

Other installations / Otras instalaciones.

pag. 126 .WS

WR

RUBIX	ref.	dimensions mm.	inst.	finish	optic options	power	CRI	K	eff. Lm/W <sup>*1</sup>	lumen max. <sup>*1</sup>	dimm opt.	tech opt.	watt max.	mA	sketch
	<b>K51205</b>	<b>.01</b> Ø75x68	<b>.WR</b>	●	■	<b>.ST</b>	<b>.8</b>	80	<b>.30</b>	65	▲	◆	3	600	
		Ø66x65 mm.		● ext-int finish <b>.WH-WH</b>	■				▲		◆		<b>K51205.01.WR.XX.ST.8.30</b>		

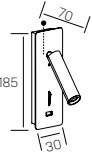
\*<sup>1</sup> Real values / Valores reales. \*<sup>2</sup> Product contains a splice box / El producto contiene caja de conexión.

SIGN	ref.	dimensions mm.	inst.	finish	optic options	power	CRI	K	eff. Lm/W <sup>*</sup>	lumen max. <sup>*</sup>	dimm opt.	tech opt.	watt max.	mA	sketch
	<b>K50702</b>	<b>.01</b> 70x30x185	<b>.WR</b>	●	■	<b>.ST</b>	<b>.8</b>	80	<b>.30</b>	49	▲	◆	3	650	
		56x175 mm.		● ext-int finish <b>.BK-BK   .WH-WH</b>	■				▲		◆		<b>K50702.01.WR.XX.ST.8.30</b>		

\* Please might expect a max. 15% value reduction in finishes other than white. / Puede haber una reducción máx. del 15% en el dato de los acabados distintos al blanco.

indoor

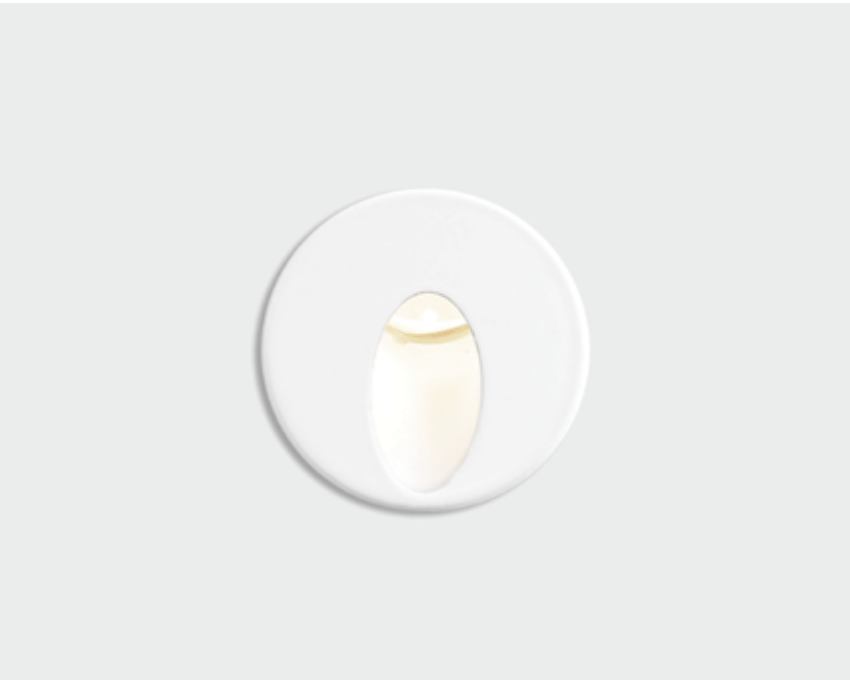

# jadex

K51203

- ALUMINIUM
- IP20 / IP54
- IK05
- LIGHT DIRECTION FIXED
- NON DIMMABLE
- INTEGRATED
- 0°
- 0°
- INDOOR OUTDOOR
- 220-240 V 50-60 Hz
- LIFE 50.000h
- WARRANTY 5 Years
- CE
- RoHS

WR

indoor

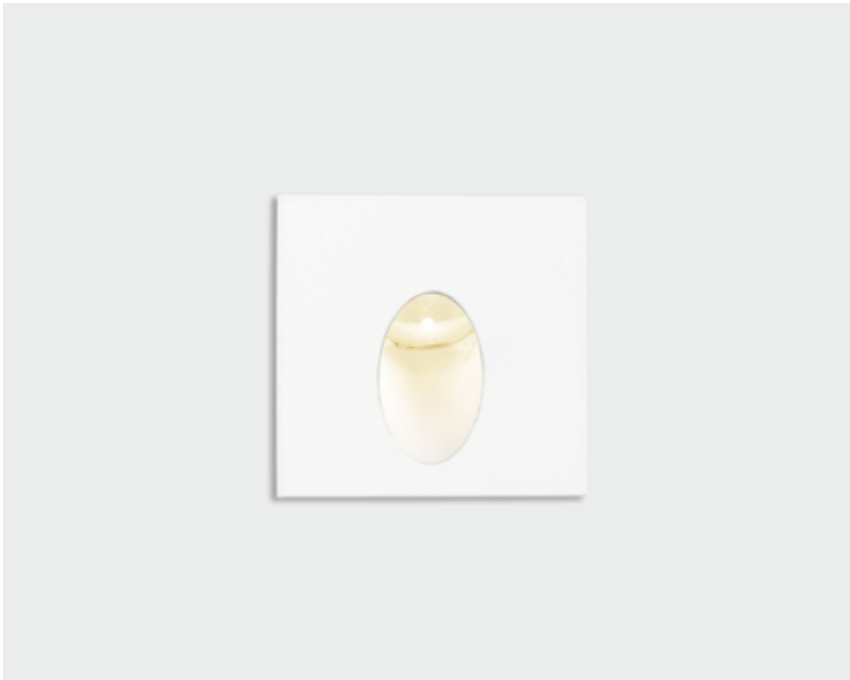

# jadex sq

K51204

- ALUMINIUM
- IP20 / IP54
- IK05
- LIGHT DIRECTION FIXED
- NON DIMMABLE
- INTEGRATED
- 0°
- 0°
- INDOOR OUTDOOR
- 220-240 V 50-60 Hz
- LIFE 50.000h
- WARRANTY 5 Years
- CE
- RoHS

WR

JADEX	ref.	dimensions mm.	inst.	finish	optic options	power	CRI	K	eff. Lm/W*1	lumen max.*1	dimm opt.	tech opt.	watt max.	mA	sketch
	<b>K51203</b>	.01 Ø55x68,5	.WR	●	■	.ST	.8	80	.30	65	▲	◆	3	600	
		Ø45x103 mm.		● ext-int finish .WH-WH	■	▲	◆	<b>K51203.01.WR.XX.ST.8.30</b>							

\*1 Real values / Valores reales. \*2 Product contains a splice box / El producto contiene caja de conexión.

JADEX SQ	ref.	dimensions mm.	inst.	finish	optic options	power	CRI	K	eff. Lm/W*1	lumen max.*1	dimm opt.	tech opt.	watt max.	mA	sketch
	<b>K51204</b>	.01 55x55x68,5	.WR	●	■	.ST	.8	80	.30	65	▲	◆	3	600	
		Ø45x103 mm.		● ext-int finish .WH-WH	■	▲	◆	<b>K51204.01.WR.XX.ST.8.30</b>							

\*1 Real values / Valores reales. \*2 Product contains a splice box / El producto contiene caja de conexión.



indoor



agatar

K51201



WR

rubix topaz

K51202



indoor

WR

AGATAR	ref.	dimensions mm.	inst.	finish	optic options	power	CRI	K	eff. Lm/W <sup>*1</sup>	lumen max. <sup>*1</sup>	dimm opt.	tech opt.	watt max.	mA	sketch	
	<b>K51201</b>	<b>.01</b> 70x79x70	<b>.WR</b>	●	■	<b>.ST</b>	<b>.8</b>	80	<b>.30</b>	100	305	▲	◆	3	300	
		60x67x76 mm.		● ext-int finish <b>.WH-WH</b>	■					▲	◆	●	<b>K51201.01.WR.XX.ST.8.30</b>			

\*1 Real values / Valores reales. \*2 Product contains a splice box / El producto contiene caja de conexión.

RUBIX TOPAZ	ref.	dimensions mm.	inst.	finish	optic options	power	CRI	K	eff. Lm/W <sup>*1</sup>	lumen max. <sup>*1</sup>	dimm opt.	tech opt.	watt max.	mA	sketch	
	<b>K51202</b>	<b>.01</b> Ø50x67,5	<b>.WR</b>	●	■	<b>.ST</b>	<b>.8</b>	80	<b>.30</b>	65	196	▲	◆	3	600	
		Ø45x115 mm.		● ext-int finish <b>.WH-WH</b>	■					▲	◆	●	<b>K51202.01.WR.XX.ST.8.30</b>			

\*1 Real values / Valores reales. \*2 Product contains a splice box / El producto contiene caja de conexión.

indoor



# focus

K51200

- ALUMINIUM
- IP20 / IP23
- IK05
- LIGHT DIRECTION ADJUSTABLE
- NON DIMMABLE
- GU10
- 90°
- HONEYCOMB
- INDOOR
- 110-240 V 50-60 Hz
- LIFE 50.000h
- WARRANTY 5 Years
- CE

GU Lamps / Lámparas GU

pag. 233 **GU**

WR



FOCUS	ref.	dimensions mm.	inst.	finish	optic options	power	CRI	K	eff. Lm/W	lumen max.	dimmm opt.	tech opt.	watt max.	mA	sketch
	<b>K51200</b>	<b>.01</b> 85x74(130)*1 x130	<b>.WR</b>	●	■	-	-	-	-	-	▲	◆	8W LED	-	
			● ext-int finish <b>.BK-BK   .WH-WH</b>		■ <b>.GU</b>		▲		◆		● ■ ◆		<b>K51200.01.WR.XX.GU</b>		
		70x130x150													

\*1 Luminaire's total height includes lamp and lamp holder. La altura total de la luminaria incluye la bombilla y el portalámpara.



indoor

# TRACK LIGHT

TK



nse  
K51300

indoor

- ALUMINIUM
- IP20
- IK06
- LIGHT DIRECTION FIXED
- DIM OPTIONAL
- INTEGRATED
- 60°
- 360°
- INDOOR
- 220-240 V 50-60 Hz
- LIFE 50.000h
- WARRANTY 5 Years
- CE
- RoHS

Other installations / Otras instalaciones.

pag. 18 .SR

pag. 42 .RF

pag. 134 .TR

NSES	ref.	dimensions mm.	inst.	finish	optic options	power	CRI	K	eff. Lm/W	lumen max.	dimm opt.	tech opt.	watt max.	mA	sketch
	K51300	.01 137x34.5x80	.TK	●	■	.ST	.9	.27	70	835	▲	◆	10	700	
								.30	73	875					
								.40	76	915					
				● ext-int finish .BK-BK   .WH-BK		.15   .30   .45		▲ .DA		◆		● ■ ▲ K51300.01.TK.XX.XX.ST.9.XX.XX			

NSES	ref.	dimensions mm.	inst.	finish	optic options	power	CRI	K	eff. Lm/W	lumen max.	dimm opt.	tech opt.	watt max.	mA	sketch
	K51300	.02 270x34.5x80	.TK	●	■	.ST	.9	.27	68	1430	▲	◆	20	600	
								.30	73	1530					
								.40	78	1630					
				● ext-int finish .BK-BK   .WH-BK		.15   .30   .45		▲ .DA		◆		● ■ ▲ K51300.02.TK.XX.XX.ST.9.XX.XX			

TK



indoor



# fame

## K51500

- ALUMINIUM
- IP20
- IK02
- LIGHT DIRECTION ADJUSTABLE
- DIM OPTIONAL
- INTEGRATED
- 90°
- 360°
- INDOOR
- 220-240 V 50-60 Hz
- LIFE 50,000h
- WARRANTY 5 Years
- CE
- RoHS

FAME	ref.	dimensions mm.	inst.	finish	optic options	power	CRI	K	eff. Lm/W*1	lumen max.*1	dimmm opt.	tech opt.	watt max.	mA	sketch
	<b>K51500</b>	<b>.01</b> 110xØ55x95	.TK	●	■	.ST	.8	80	.30 80	830	▲	◆	10	250	
				● ext-int finish .BK-BK   .WH-WH			.38   .60		▲ .DA		◆		K51500.01.TK.XX.38.ST.8.XX.XX		

FAME	ref.	dimensions mm.	inst.	finish	optic options	power	CRI	K	eff. Lm/W*1	lumen max.*1	dimmm opt.	tech opt.	watt max.	mA	sketch
	<b>K51500</b>	<b>.02</b> 155xØ75x120	.TK	●	■	.ST	.8	80	.30 85	1710	▲	◆	20	500	
				● ext-int finish .BK-BK   .WH-WH			.38   .60		▲ .DA		◆		K51500.02.TK.XX.38.ST.8.XX.XX		

FAME	ref.	dimensions mm.	inst.	finish	optic options	power	CRI	K	eff. Lm/W*1	lumen max.*1	dimmm opt.	tech opt.	watt max.	mA	sketch
	<b>K51500</b>	<b>.03</b> 185xØ75x120	.TK	●	■	.ST	.8	80	.30 84	2430	▲	◆	30	700	
				● ext-int finish .BK-BK   .WH-WH			.38   .60		▲ .DA		◆		K51500.03.TK.XX.38.ST.8.XX.XX		

\*1 Please might expect a max. 15% value reduction in finishes other than white. / Puede haber una reducción máx. del 15% en el dato de los acabados distintos al blanco.

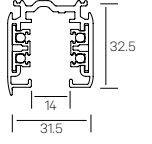

# 3-CIRCUIT TRACK

3-CIRCUIT TRACK	ref	track lenght	inst.	finish	dimm. opt.	
	<b>K3-CT</b>	<b>.01</b> 1000mm <b>.02</b> 2000mm	<b>.RF</b>	<b>.BK-BK</b> <b>.GY-GY</b> <b>.WH-WH</b>	<b>.DA</b>	
			<b>.SR*</b>			

\* Add pendant mounting to track profile K3-CT.01.SR & K3-CT.02.SR with accesories K3-CTWS.PN + K3-CTCB / Añade instalación colgante al perfil track K3-CT.01.SR y K3-CT.02.SR con los accesorios K3-CTWS.PN + K3-CTCB.



L-CORNER ADJUSTABLE UNIÓN AJUSTABLE L	
ref.	<b>K3-CTL-CA</b>
finish	<b>.WH-WH</b>
	<b>.BK-BK</b>
	<b>.GY-GY</b>
dimm. opt.	<b>.DA</b>

L-CORNER UNIÓN L	
ref.	<b>K3-CTL-C</b>
finish	<b>.WH-WH</b>
	<b>.BK-BK</b>
	<b>.GY-GY</b>
dimm. opt.	<b>.DA</b>

T-ANGLE UNIÓN T	
ref.	<b>K3-CTT-A</b>
finish	<b>.WH-WH</b>
	<b>.BK-BK</b>
	<b>.GY-GY</b>
dimm. opt.	<b>.DA</b>

X-ANGLE UNIÓN X	
ref.	<b>K3-CTT-X</b>
finish	<b>.WH-WH</b>
	<b>.BK-BK</b>
	<b>.GY-GY</b>
dimm. opt.	<b>.DA</b>

MIDDLE FEED CORRIENTE MEDIA	
ref.	<b>K3-CTMF</b>
finish	<b>.WH-WH</b>
	<b>.BK-BK</b>
	<b>.GY-GY</b>
dimm. opt.	<b>.DA</b>

STRAIGHT CONNECTOR CONECTOR RECTO	
ref.	<b>K3-CTSC</b>
finish	<b>.WH-WH</b>
	<b>.BK-BK</b>
	<b>.GY-GY</b>
dimm. opt.	<b>.DA</b>

POWER SUPPLY CONEXIÓN DE ALIMENTACIÓN	
ref.	<b>K3-CTPS</b>
finish	<b>.WH-WH</b>
	<b>.BK-BK</b>
	<b>.GY-GY</b>
dimm. opt.	<b>.DA</b>

END CAP TAPA FINAL	
ref.	<b>K3-CTC</b>
finish	<b>.WH-WH</b>
	<b>.BK-BK</b>
	<b>.GY-GY</b>

BRACKET FOR PENDANT INST. BRACKET PARA INST. COLGANTE	
ref.	<b>K3-CTCB</b>
finish	<b>.WH-WH</b>
	<b>.BK-BK</b>
	<b>.GY-GY</b>

CABLE FOR PENDANT INST. 3m CABLE PARA INST. COLGANTE 3m	
ref.	<b>K3-CTWS.PN</b>
finish	<b>.WH-WH</b>
	<b>.BK-BK</b>
	<b>.GY-GY</b>

Accesories are delivered separately (not installed in luminaire) / Los accesorios se sirven por separado (no instalados en la luminaria).

Accesories are delivered separately (not installed in luminaire) / Los accesorios se sirven por separado (no instalados en la luminaria).



PENDANT

indoor

PN





chas  
K51400

indoor

PC IP20 IK05 LIGHT DIRECTION FIXED NON DIMMABLE

INTEGRATED 0° 0° INDOOR 220-240 V 50-60 Hz

OPAL LIFE 50.000h WARRANTY 5 Years CE

Other installations / Otras instalaciones.

pag. 29 .SR

PN

CHAS	ref.	dimensions mm.	inst.	finish	optic options	power	CRI	K	eff. Lm/W	lumen max.	dimm opt.	tech opt.	watt max.	mA	sketch
	<b>K51400</b>	<b>.01</b> Ø460x1200	<b>.PN</b>	●	■	<b>.ST</b>	<b>.8</b> 80	<b>.30</b>	100	3000	▲	◆	30	300	
				● ext-int finish <b>.BK-WH   GY-WH .WH-WH</b>			<b>.OP</b>								<b>K51400.01.PN.XX.OP.ST.8.30</b>

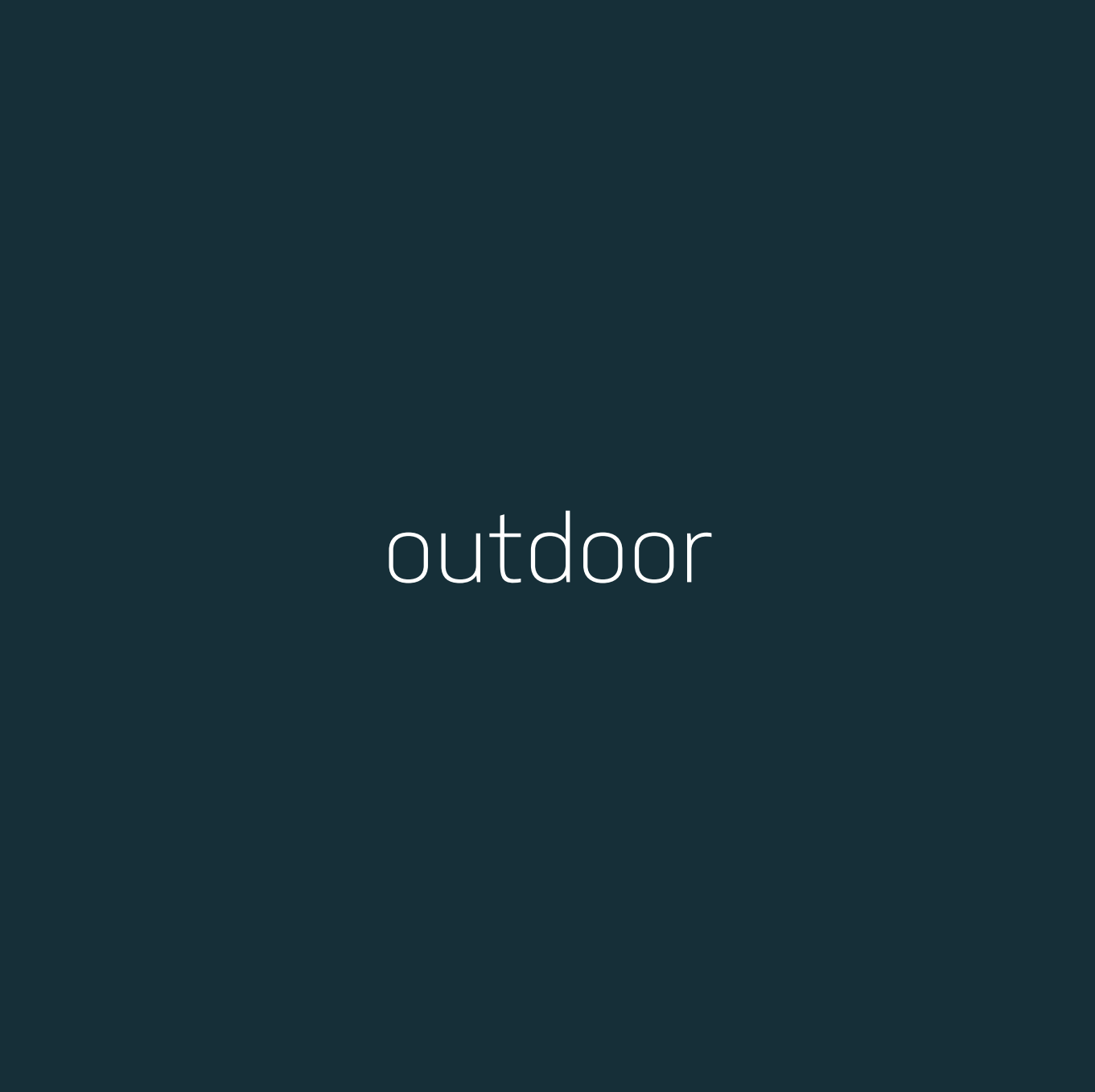
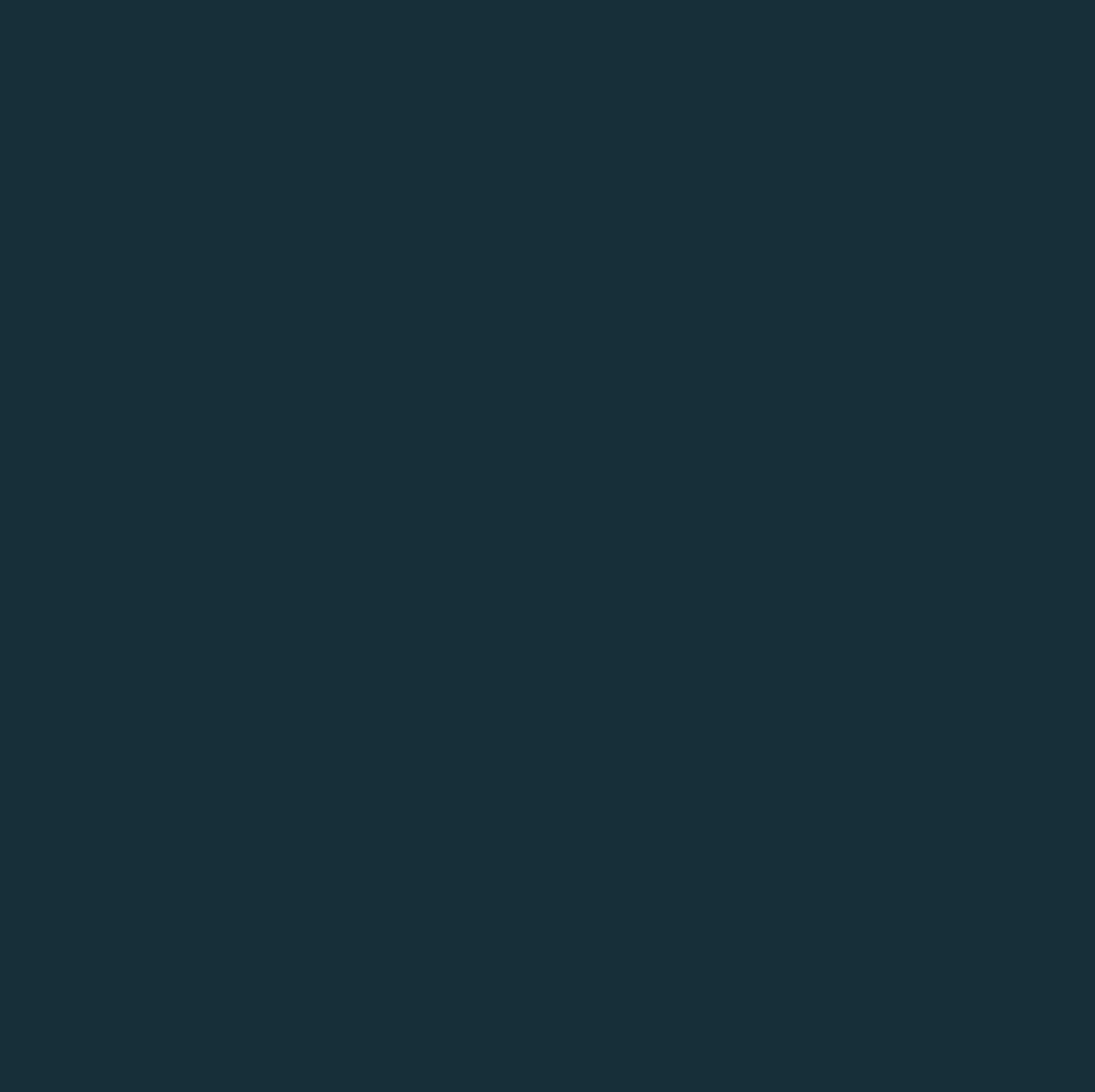

outdoor





SURFACE

outdoor

SR





besel  
K60010

- ALUMINIUM
- IP65
- IK08
- LIGHT DIRECTION FIXED
- NON DIMMABLE
- Grounding symbol
- Light direction icon
- 0°
- 0°
- OUTDOOR
- 220-240 V 50-60 Hz
- Light bulb icon
- LIFE 50.000h
- WARRANTY 5 Years
- CE
- Recycling symbol

outdoor  
SR

BESEL	ref.	dimensions mm.	inst.	finish	optic options	power	CRI	K	eff. Lm/W	lumen max.	dimmm opt.	tech opt.	watt max.	mA	sketch
	<b>K60010</b>	<b>.01</b> Ø250x56	<b>.SR</b>	●	■	<b>.ST</b>	<b>.8</b> 80	<b>.30</b>	87	1700	▲	◆	20	-	
				● ext-int finish <b>.DG-DG   .WH-WH</b>			■		▲		◆		<b>K60010.01.SR.XX.OP.ST.8.30</b>		

Product is delivered with IP66 screen printing and Kohl logo, if you want it unprinted, please consult with the Kohl Team.  
El producto se envía con serigrafía IP66 y logo Kohl, si lo quieren sin serigrafía por favor consulten con el Equipo Kohl.

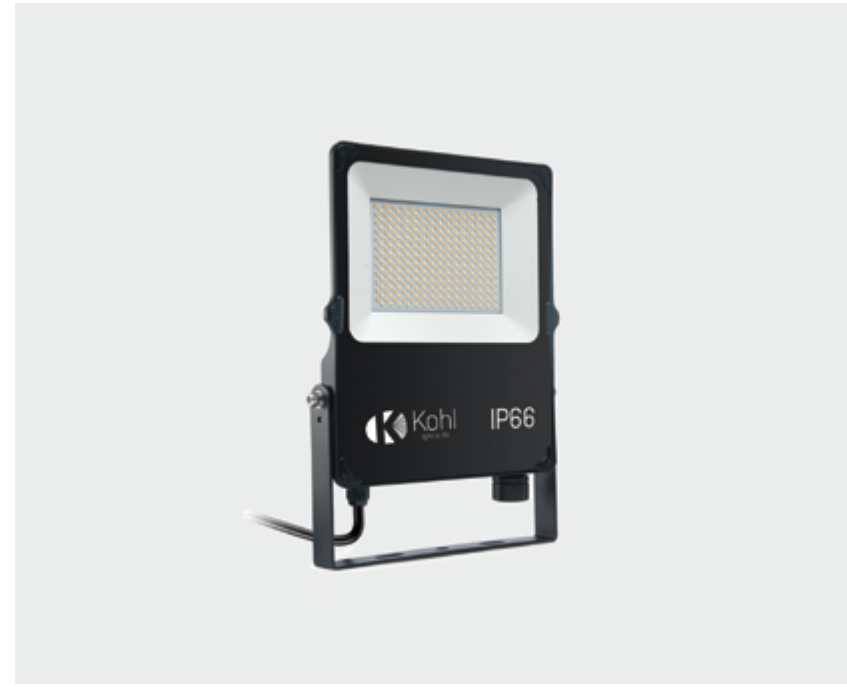

# storm pro k-select K60011



STORM PRO K-SELECT	ref.	dimensions mm.	inst.	finish	optic options	power	CRI	K*1	eff. Lm/W	lumen max.	dimm opt.	tech opt.	watt max.	mA	sketch	
	<b>K60011</b>	<b>.01</b> 182x47x122	<b>.SR</b>	●	■	<b>.ST</b>	<b>.8</b>	80	<b>.30</b>	93	1850	▲	◆	20	75	
									<b>.40</b>	95	1900					
									<b>.50</b>	98	1950					
									● ext-int finish <b>.BK-BK</b>							

STORM PRO K-SELECT	ref.	dimensions mm.	inst.	finish	optic options	power	CRI	K*1	eff. Lm/W	lumen max.	dimm opt.	tech opt.	watt max.	mA	sketch	
	<b>K60011</b>	<b>.03</b> 282x52x204	<b>.SR</b>	●	■	<b>.ST</b>	<b>.8</b>	80	<b>.30</b>	99	4930	▲	◆	50	200	
									<b>.40</b>	99	4950					
									<b>.50</b>	100	5000					
									● ext-int finish <b>.BK-BK</b>							

STORM PRO K-SELECT	ref.	dimensions mm.	inst.	finish	optic options	power	CRI	K*1	eff. Lm/W	lumen max.	dimm opt.	tech opt.	watt max.	mA	sketch	
	<b>K60011</b>	<b>.02</b> 242x51x169	<b>.SR</b>	●	■	<b>.ST</b>	<b>.8</b>	80	<b>.30</b>	97	2900	▲	◆	30	120	
									<b>.40</b>	98	2950					
									<b>.50</b>	100	3000					
									● ext-int finish <b>.BK-BK</b>							

STORM PRO K-SELECT	ref.	dimensions mm.	inst.	finish	optic options	power	CRI	K*1	eff. Lm/W	lumen max.	dimm opt.	tech opt.	watt max.	mA	sketch	
	<b>K60011</b>	<b>.04</b> 337x52x269	<b>.SR</b>	●	■	<b>.ST</b>	<b>.8</b>	80	<b>.30</b>	99	9900	▲	◆	100	350	
									<b>.40</b>	99	9950					
									<b>.50</b>	100	10000					
									● ext-int finish <b>.BK-BK</b>							

\*1 The luminaire includes three color temperatures (3000K-4000K-5000K), manually selectable before its installation by switch. / La luminaria incluye las tres temperaturas de color (3000K-4000K-5000K), seleccionables de forma manual antes de su instalación mediante switch.

\*2 K-select model is indicated by .01 in the nomenclature. / El modelo k-select, se indica con .01 en la nomenclatura.

\*1 The luminaire includes three color temperatures (3000K-4000K-5000K), manually selectable before its installation by switch. / La luminaria incluye las tres temperaturas de color (3000K-4000K-5000K), seleccionables de forma manual antes de su instalación mediante switch.

\*2 K-select model is indicated by .01 in the nomenclature. / El modelo k-select, se indica con .01 en la nomenclatura.





WALL  
SURFACE

outdoor

WS



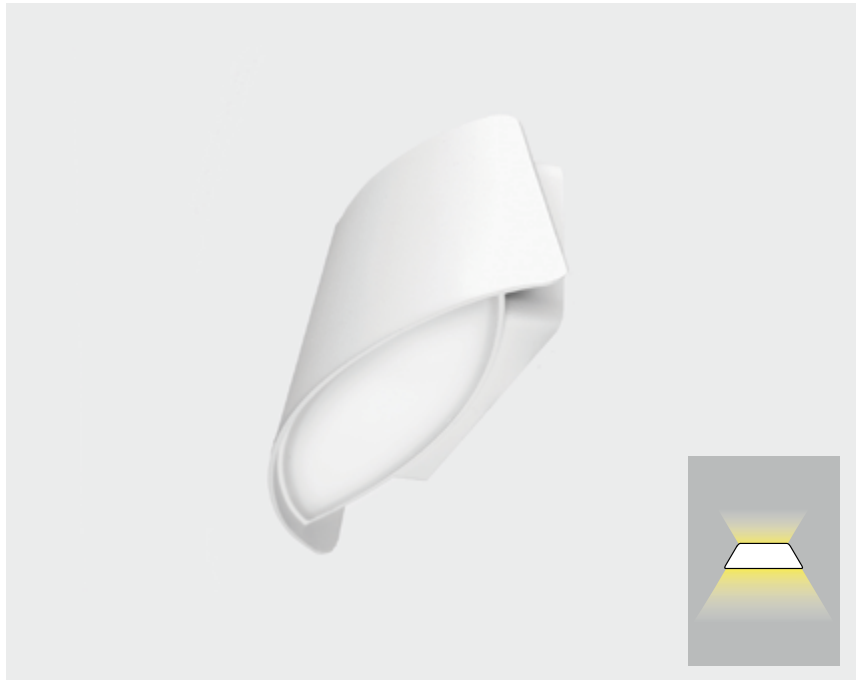

## cap K60002

- ALUMINIUM
- IP65
- IK08
- LIGHT DIRECTION FIXED
- NON DIMMABLE
- INTEGRATED
- 0°
- 0°
- OUTDOOR
- 220-240 V 50-60 Hz
- LIFE 50.000h
- WARRANTY 5 Years
- CE
- RoHS



## tuile K60005

- ALUMINIUM
- IP65
- IK08
- LIGHT DIRECTION FIXED
- NON DIMMABLE
- INTEGRATED
- 0°
- 0°
- OUTDOOR
- 220-240 V 50-60 Hz
- LIFE 50.000h
- WARRANTY 5 Years
- CE
- RoHS

outdoor

outdoor

WS

CAP	ref.	dimensions mm.	inst.	finish	optic options	power	CRI	K	eff. Lm/W*1	lumen max.*1	dim. opt.	tech opt.	watt max.	mA	sketch	
	<b>K60002</b>	<b>.01</b> 235x65x77	<b>.WS</b>	●	■	<b>.ST</b>	<b>.8</b>	80	<b>.30</b>	68	590	▲	◆	9	300	
				● ext-int finish <b>.DG-DG   .WH-WH</b>		■		▲		◆		<b>K60002.01.WS.XX.OP.ST.8.30</b>				

\*1 Please might expect a max. 15% value reduction in finishes other than white. / Puede haber una reducción máx. del 15% en el dato de los acabados distintos al blanco.

WS

TUILE	ref.	dimensions mm.	inst.	finish	optic options	power	CRI	K	eff. Lm/W*1	lumen max.*1	dim. opt.	tech opt.	watt max.	mA	sketch	
	<b>K60005</b>	<b>.01</b> 106x51x174	<b>.WS</b>	●	■	<b>.ST</b>	<b>.8</b>	80	<b>.30</b>	54	560	▲	◆	11	300	
				● ext-int finish <b>.DG-DG   .WH-WH</b>		■		▲		◆		<b>K60005.01.WS.XX.OP.ST.8.30</b>				

\*1 Please might expect a max. 15% value reduction in finishes other than white. / Puede haber una reducción máx. del 15% en el dato de los acabados distintos al blanco.

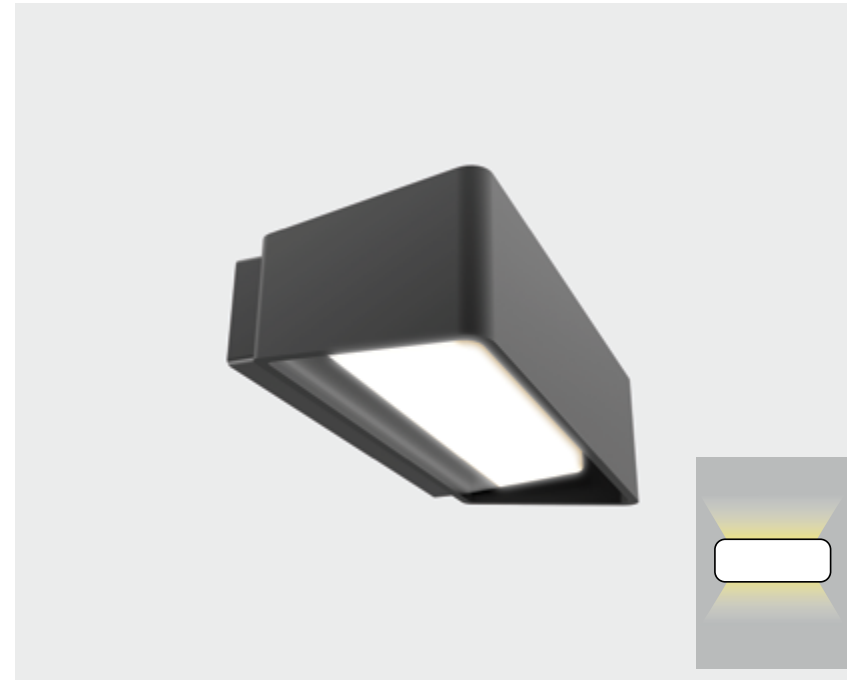

pat  
K60003

- ALUMINIUM
- IP65
- IK08
- LIGHT DIRECTION FIXED
- NON DIMMABLE
- INTEGRATED
- 0°
- 0°
- OUTDOOR
- 220-240 V 50-60 Hz
- LIFE 50.000h
- WARRANTY 5 Years
- CE
- RoHS

outdoor

PAT	ref.	dimensions mm.	inst.	finish	optic options	power	CRI	K	eff. Lm/W*1	lumen max.*1	dimm opt.	tech opt.	watt max.	mA	sketch
	<b>K60003</b>	<b>.01</b> 248x117x70	<b>.WS</b>	●	■	<b>.ST</b>	<b>.8</b> 80	<b>.30</b>	56	700	▲	◆	13	300	
				● ext-int finish <b>.DG-DG   .WH-WH</b>	■			<b>.OP</b>			▲	◆			<b>K60003.01.WS.XX.OP.ST.8.30</b>

\*1 Please might expect a max. 15% value reduction in finishes other than white. / Puede haber una reducción máx. del 15% en el dato de los acabados distintos al blanco.



# tap

K60004

- ALUMINIUM
- IP65
- IK08
- LIGHT DIRECTION FIXED
- NON DIMMABLE
- INTEGRATED
- 0°
- 0°
- OUTDOOR
- 220-240 V 50-60 Hz
- LIFE 50.000h
- WARRANTY 5 Years
- CE
- RoHS



# grubi

K60201

- ALUMINIUM
- IP65
- IK08
- LIGHT DIRECTION FIXED
- NON DIMMABLE
- INTEGRATED
- 0°
- 0°
- OUTDOOR
- 220-240 V 50-60 Hz
- LIFE 50.000h
- WARRANTY 5 Years
- CE
- RoHS

Other installations / Otras instalaciones.

pag. 210 .FL



outdoor

outdoor

WS

TAP	ref.	dimensions mm.	inst.	finish	optic options	power	CRI	K	eff. Lm/W	lumen max.	dim. opt.	tech. opt.	watt max.	mA	sketch	
	K60004	.01 175x114x60	.WS	●	■	.ST	.8	80	.30	46	300	▲	◆	7	300	
				● ext-int finish .DG-DG   .WH-WH				■ .OP			▲	◆	K60004.01.WS.XX.OP.ST.8.30			

GRUBI	ref.	dimensions mm.	inst.	finish	optic options	power	CRI	K	eff. Lm/W	lumen max.	dim. opt.	tech. opt.	watt max.	mA	sketch	
	K60201	.01 152x121x145	.WS	●	■	.ST	.8	80	.30	32	415	▲	◆	13	300	
				● ext-int finish .DG-DG				■			▲	◆	K60201.01.WS.XX.ST.8.30			

WS



esti  
K60301

- ALUMINIUM
- IP54
- IK08
- LIGHT DIRECTION FIXED
- NON DIMMABLE
- INTEGRATED
- 0°
- 0°
- OUTDOOR
- 220-240 V 50-60 Hz
- LIFE 50.000h
- WARRANTY 5 Years
- CE
- RoHS

Other installations / Otras instalaciones.

.FL pag. 211



outdoor

WS

ESTI	ref.	dimensions mm.	inst.	finish	optic options	power	CRI	K	eff. Lm/W	lumen max.	dim. opt.	tech. opt.	watt max.	mA	sketch	
	K60301	.01 128x169x200	.WS	●	■	.ST	.8	80	.30	30	270	▲	◆	9	300	
				● ext-int finish .DG-DG				■			▲	◆			● K60301.01.WS.XX.ST.8.30	



way  
K60401

- ALUMINIUM
- IP54
- IK08
- LIGHT DIRECTION FIXED
- NON DIMMABLE
- INTEGRATED
- 0°
- 0°
- OUTDOOR
- 220-240 V 50-60 Hz
- LIFE 50.000h
- WARRANTY 5 Years
- CE
- RoHS

Other installations / Otras instalaciones.

.FL pag. 214



outdoor

WS

WAY	ref.	dimensions mm.	inst.	finish	optic options	power	CRI	K	eff. Lm/W	lumen max.	dim. opt.	tech. opt.	watt max.	mA	sketch	
	K60401	.01 203x153x250	.WS	●	■	.ST	.8	80	.30	37	330	▲	◆	9	300	
				● ext-int finish .DG-DG				■			▲	◆			● K60401.01.WS.XX.ST.8.30	



# senda

K60501

- ALUMINIUM
- IP54
- IK08
- LIGHT DIRECTION FIXED
- NON DIMMABLE
- INTEGRATED
- 0°
- 0°
- OUTDOOR
- 220-240 V 50-60 Hz
- LIFE 50.000h
- WARRANTY 5 Years
- CE
- RoHS

Other installations / Otras instalaciones.

pag. 215 .FL



outdoor

WS

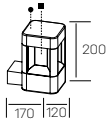
SEND A	ref.	dimensions mm.	inst.	finish	optic options	power	CRI	K	eff. Lm/W	lumen max.	dim. opt.	tech. opt.	watt max.	mA	sketch
	<b>K60501</b>	<b>.01</b> 120x170x200	<b>.WS</b>	●	■	<b>.ST</b>	<b>.8</b>	80	<b>.30</b>	14	120	▲	9	300	
				● ext-int finish <b>.DG-DG</b>				■		▲		●		<b>K60501.01.WS.XX.ST.8.30</b>	



# comet

K60600

- ALUMINIUM
- IP65
- IK08
- LIGHT DIRECTION ADJUSTABLE
- NON DIMMABLE
- INTEGRATED
- 90°
- 0°
- OUTDOOR
- 220-240 V 50-60 Hz
- LIFE 50.000h
- WARRANTY 5 Years
- CE
- RoHS

Other installations / Otras instalaciones.

pag. 219 .FL

outdoor

WS

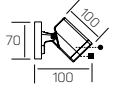
COMET	ref.	dimensions mm.	inst.	finish	optic options	power	CRI	K	eff. Lm/W	lumen max.	dim. opt.	tech. opt.	watt max.	mA	sketch
	<b>K60600</b>	<b>.01</b> 70x100x100	<b>.WS</b>	●	■	<b>.ST</b>	<b>.8</b>	80	<b>.30</b>	84	495	▲	7	160	
				● ext-int finish <b>.DG-DG</b>				■		▲		●		<b>K60600.01.WS.XX.30.ST.8.30</b>	



# mike

K60701

- ALUMINIUM
- IP54
- IK08
- LIGHT DIRECTION FIXED
- NON DIMMABLE
- INTEGRATED
- 0°
- 0°
- OUTDOOR
- 220-240 V 50-60 Hz
- LIFE 50.000h
- WARRANTY 5 Years
- CE
- Recycling symbol

Other installations / Otras instalaciones.

pag. 217 .FL



outdoor

WS

MIKE	ref.	dimensions mm.	inst.	finish	optic options	power	CRI	K	eff. Lm/W	lumen max.	dim. opt.	tech. opt.	watt max.	mA	sketch
	<b>K60701</b>	<b>.01</b> 150x234x250	<b>.WS</b>	●	■	<b>.ST</b>	<b>.8</b>	80	<b>.30</b>	40	280	▲	7	300	
				● ext-int finish <b>.DG-DG</b>						▲				● <b>K60701.01.WS.XX.ST.8.30</b>	



▲

▲

# safiro

K60006



outdoor

WS

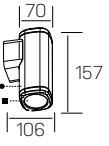
SAFIRO	ref.	dimensions mm.	inst.	finish	optic options	power	CRI	K	eff. Lm/W	lumen max.	dimm opt.	tech opt.	watt max.	mA	sketch
	<b>K60006</b>	<b>.01</b> 70x106x157	<b>.WS</b>	●	■	<b>.ST</b>	<b>.8</b> 80	<b>.30</b>	65	210	▲	◆	3,5	350	
				● ext-int finish <b>.DG-DG</b>	■ <b>.80</b>						▲	◆	<b>K60006.01.WS.XX.80.ST.8.30</b>		



▲





# safiro due

K60007

- ALUMINIUM
- IP54
- IK08
- LIGHT DIRECTION FIXED
- NON DIMMABLE
- INTEGRATED
- 0°
- 0°
- OUTDOOR
- 220-240 V 50-60 Hz
- LIFE 50.000h
- WARRANTY 5 Years
- CE
- Recycling symbol



# hammer

K60000

- ALUMINIUM
- IP65
- IK06
- LIGHT DIRECTION FIXED
- NON DIMMABLE
- INTEGRATED
- 0°
- 0°
- OUTDOOR
- 220-240 V 50-60 Hz
- LIFE 50.000h
- WARRANTY 5 Years
- CE
- Recycling symbol

outdoor

outdoor

WS

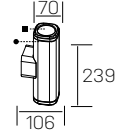
SAFIRO DUE	ref.	dimensions mm.	inst.	finish	optic options	power	CRI	K	eff. Lm/W	lumen max.	dim. opt.	tech. opt.	watt max.	mA	sketch	
	<b>K60007</b>	<b>.01</b> 70x106x239	<b>.WS</b>	●	■	<b>.ST</b>	<b>.8</b>	80	<b>.30</b>	67	590	▲	◆	7	300	
				● ext-int finish <b>.DG-DG</b>	■	<b>.90</b>		▲	◆							<b>K60007.01.WS.XX.90.ST.8.30</b>

WS

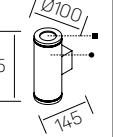
HAMMER	ref.	dimensions mm.	inst.	finish	optic options	power	CRI	K	eff. Lm/W	lumen max.	dim. opt.	tech. opt.	watt max.	mA	sketch	
	<b>K60000</b>	<b>.01</b> Ø100x145 x275	<b>.WS</b>	●	■	<b>.ST</b>	<b>.9</b>	90	<b>.30</b>	98	3000	▲	◆	30	700	
				● ext-int finish <b>.BK-BK   .GY-GY</b>	■	<b>.15</b>		▲	◆							<b>K60000.01.WS.XX.15.ST.9.30</b>



# hammer sq

K60001

- ALUMINIUM
- IP65
- IK08
- LIGHT DIRECTION FIXED
- NON DIMMABLE
- INTEGRATED
- 0°
- 0°
- OUTDOOR
- 220-240 V 50-60 Hz
- LIFE 50.000h
- WARRANTY 5 Years
- CE

outdoor

WS

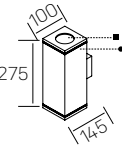
HAMMER SQ	ref.	dimensions mm.	inst.	finish	optic options	power	CRI	K	eff. Lm/W	lumen max.	dimm opt.	tech opt.	watt max.	mA	sketch
	<b>K60001</b>	<b>.01</b> 100x145x275	<b>.WS</b>	●	■	<b>.ST</b>	<b>.8</b> 80	<b>.30</b>	98	3000	▲	◆	30	700	
				● ext-int finish <b>.BK-BK   .GY-GY</b>				■ <b>.15</b>		▲		◆	● ■ <b>K60001.01.WS.XX.15.ST.8.30</b>		

# prisma due

K60008



outdoor

WS

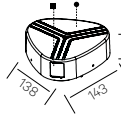
PRISMA DUE	ref.	dimensions mm.	inst.	finish	optic options	power	CRI	K	eff. Lm/W	lumen max.	dim. opt.	tech. opt.	watt max.	mA	sketch	
	<b>K60008</b>	<b>.01</b> 138x143x44	<b>.WS</b>	●	■	<b>.ST</b>	8	80	<b>.30</b>	53	375	▲	◆	7	300	
				● ext-int finish <b>.DG-DG</b>	■ <b>.70</b>	▲	◆									<b>K60008.01.WS.XX.70.ST.8.30</b>

# prisma tre

K60009



outdoor

WS

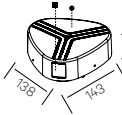
PRISMA TRE	ref.	dimensions mm.	inst.	finish	optic options	power	CRI	K	eff. Lm/W	lumen max.	dim. opt.	tech. opt.	watt max.	mA	sketch	
	<b>K60009</b>	<b>.01</b> 138x143x44	<b>.WS</b>	●	■	<b>.ST</b>	8	80	<b>.30</b>	53	375	▲	◆	7	300	
				● ext-int finish <b>.DG-DG</b>	■ <b>.70</b>	▲	◆									<b>K60009.01.WS.XX.70.ST.8.30</b>





WALL  
RECESSED



outdoor

WR

# onik IP65

K60102



# onik due IP65



K60103

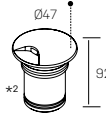
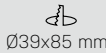

outdoor

outdoor

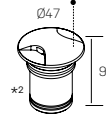
ONIK IP65	ref.	dimensions mm.	inst.	finish	optic options	power	CRI	K	eff. Lm/W*1	lumen max.*1	dimm opt.	tech opt.	watt max.	mA	sketch	
	<b>K60102</b>	<b>.01</b> Ø47x92,5	<b>.WR</b>	●	■	<b>.ST</b>	<b>.8</b>	80	<b>.30</b>	65	196	▲	◆	3	600	
		Ø39x85 mm.	-	● ext-int finish <b>.WH-WH</b>	■	-	-	-	▲	◆	-	◆	<b>K60102.01.WR.XX.ST.8.30</b>			

ONIK DUE IP65	ref.	dimensions mm.	inst.	finish	optic options	power	CRI	K	eff. Lm/W*1	lumen max.*1	dimm opt.	tech opt.	watt max.	mA	sketch	
	<b>K60103</b>	<b>.01</b> Ø47x92,5	<b>.WR</b>	●	■	<b>.ST</b>	<b>.8</b>	80	<b>.30</b>	65	196	▲	◆	3	600	
		Ø39x85 mm.	-	● ext-int finish <b>.WH-WH</b>	■	-	-	-	▲	◆	-	◆	<b>K60103.01.WR.XX.ST.8.30</b>			

\*1 Real values / Valores reales. \*2 Product contains a splice box / El producto contiene caja de conexión.

\*1 Real values / Valores reales. \*2 Product contains a splice box / El producto contiene caja de conexión.



# onik tre IP65

K60104

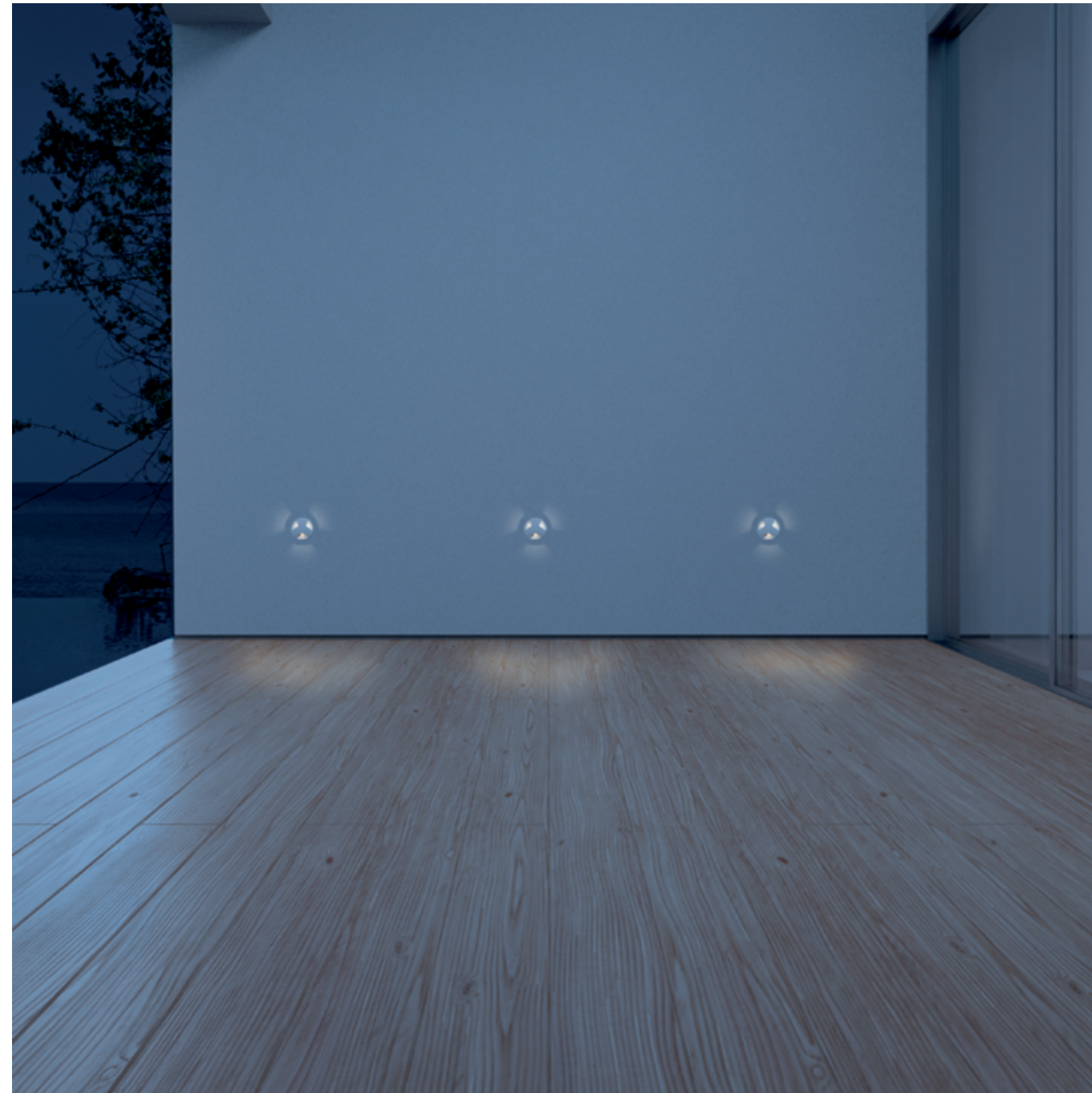

outdoor

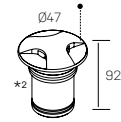

ONIK TRE IP65	ref.	dimensions mm.	inst.	finish	optic options	power	CRI	K	eff. Lm/W <sup>*1</sup>	lumen max. <sup>*1</sup>	dimm opt.	tech opt.	watt max.	mA	sketch
	<b>K60104</b>	<b>.01</b> Ø47x92,5	<b>.WR</b>	●	■	<b>.ST</b>	<b>.8</b> 80	<b>.30</b>	65	196	▲	◆	3	600	
		 Ø39x85 mm.		● ext-int finish <b>.WH-WH</b>	■					▲	◆		<b>K60104.01.WR.XX.ST.8.30</b>		

<sup>\*1</sup> Real values / Valores reales. <sup>\*2</sup> Product contains a splice box / El producto contiene caja de conexión.









FLOOR



# grubi floor

K60200



Other installations / Otras instalaciones.

pag. 181 .WS

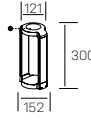
GRUBI FLOOR S	ref.	dimensions mm.	inst.	finish	optic options	power	CRI	K	eff. Lm/W	lumen max.	dimmm opt.	tech opt.	watt max.	mA	sketch	
	<b>K60200</b>	<b>.01</b> 152x121x300	<b>.FL</b>	●	■	<b>.ST</b>	<b>.8</b>	80	<b>.30</b>	57	735	▲	◆	13	300	
				● ext-int finish <b>.DG-DG</b>				■			▲	◆	● K60200.01.FL.XX. <b>ST.8.30</b>			

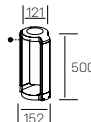
GRUBI FLOOR M	ref.	dimensions mm.	inst.	finish	optic options	power	CRI	K	eff. Lm/W	lumen max.	dimmm opt.	tech opt.	watt max.	mA	sketch	
	<b>K60200</b>	<b>.02</b> 152x121x500	<b>.FL</b>	●	■	<b>.ST</b>	<b>.8</b>	80	<b>.30</b>	57	735	▲	◆	13	300	
				● ext-int finish <b>.DG-DG</b>				■			▲	◆	● K60200.02.FL.XX. <b>ST.8.30</b>			

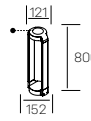
GRUBI FLOOR L	ref.	dimensions mm.	inst.	finish	optic options	power	CRI	K	eff. Lm/W	lumen max.	dimmm opt.	tech opt.	watt max.	mA	sketch	
	<b>K60200</b>	<b>.03</b> 152x121x800	<b>.FL</b>	●	■	<b>.ST</b>	<b>.8</b>	80	<b>.30</b>	57	735	▲	◆	13	300	
				● ext-int finish <b>.DG-DG</b>				■			▲	◆	● K60200.03.FL.XX. <b>ST.8.30</b>			



# esti floor

K60300



Other installations / Otras instalaciones.

pag. 182 .WS

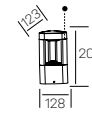
ESTI FLOOR S	ref.	dimensions mm.	inst.	finish	optic options	power	CRI	K	eff. Lm/W	lumen max.	dimmm opt.	tech opt.	watt max.	mA	sketch	
	<b>K60300</b>	<b>.01</b> 128x123x200	<b>.FL</b>	●	■	<b>.ST</b>	<b>.8</b>	80	<b>.30</b>	30	270	▲	◆	9	300	
				● ext-int finish <b>.DG-DG</b>				■			▲	◆	● K60300.01.FL.XX. <b>ST.8.30</b>			

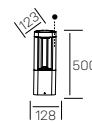
ESTI FLOOR M	ref.	dimensions mm.	inst.	finish	optic options	power	CRI	K	eff. Lm/W	lumen max.	dimmm opt.	tech opt.	watt max.	mA	sketch	
	<b>K60300</b>	<b>.02</b> 128x123x500	<b>.FL</b>	●	■	<b>.ST</b>	<b>.8</b>	80	<b>.30</b>	40	350	▲	◆	9	300	
				● ext-int finish <b>.DG-DG</b>				■			▲	◆	● K60300.02.FL.XX. <b>ST.8.30</b>			

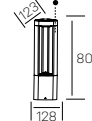
ESTI FLOOR L	ref.	dimensions mm.	inst.	finish	optic options	power	CRI	K	eff. Lm/W	lumen max.	dimmm opt.	tech opt.	watt max.	mA	sketch	
	<b>K60300</b>	<b>.03</b> 128x123x800	<b>.FL</b>	●	■	<b>.ST</b>	<b>.8</b>	80	<b>.30</b>	40	350	▲	◆	9	300	
				● ext-int finish <b>.DG-DG</b>				■			▲	◆	● K60300.03.FL.XX. <b>ST.8.30</b>			





# way floor

K60400

Other installations / Otras instalaciones.

pag. 183 .WS



WAY FLOOR S	ref.	dimensions mm.	inst.	finish	optic options	power	CRI	K	eff. Lm/W	lumen max.	dim. opt.	tech. opt.	watt max.	mA	sketch	
	K60400	.01 120x120x200	.FL	●	■	.ST	.8	80	.30	37	330	▲	◆	9	300	
				● ext-int finish .DG-DG				■		▲		◆		K60400.01.FL.XX.ST.8.30		

WAY FLOOR M	ref.	dimensions mm.	inst.	finish	optic options	power	CRI	K	eff. Lm/W	lumen max.	dim. opt.	tech. opt.	watt max.	mA	sketch	
	K60400	.02 120x120x500	.FL	●	■	.ST	.8	80	.30	40	360	▲	◆	9	300	
				● ext-int finish .DG-DG				■		▲		◆		K60400.02.FL.XX.ST.8.30		

WAY FLOOR L	ref.	dimensions mm.	inst.	finish	optic options	power	CRI	K	eff. Lm/W	lumen max.	dim. opt.	tech. opt.	watt max.	mA	sketch	
	K60400	.03 120x120x800	.FL	●	■	.ST	.8	80	.30	40	360	▲	◆	9	300	
				● ext-int finish .DG-DG				■		▲		◆		K60400.03.FL.XX.ST.8.30		



# senda floor

K60500

Other installations / Otras instalaciones.

pag. 184 .WS



SENDA FLOOR S	ref.	dimensions mm.	inst.	finish	optic options	power	CRI	K	eff. Lm/W	lumen max.	dim. opt.	tech. opt.	watt max.	mA	sketch	
	K60500	.01 120x120x200	.FL	●	■	.ST	.8	80	.30	14	120	▲	◆	9	300	
				● ext-int finish .DG-DG				■		▲		◆		K60500.01.FL.XX.ST.8.30		

SENDA FLOOR M	ref.	dimensions mm.	inst.	finish	optic options	power	CRI	K	eff. Lm/W	lumen max.	dim. opt.	tech. opt.	watt max.	mA	sketch	
	K60500	.02 120x120x500	.FL	●	■	.ST	.8	80	.30	17	150	▲	◆	9	300	
				● ext-int finish .DG-DG				■		▲		◆		K60500.02.FL.XX.ST.8.30		

SENDA FLOOR L	ref.	dimensions mm.	inst.	finish	optic options	power	CRI	K	eff. Lm/W	lumen max.	dim. opt.	tech. opt.	watt max.	mA	sketch	
	K60500	.03 120x120x800	.FL	●	■	.ST	.8	80	.30	17	150	▲	◆	9	300	
				● ext-int finish .DG-DG				■		▲		◆		K60500.03.FL.XX.ST.8.30		



# mike floor

K60700



- ALUMINIUM
- IP54
- IK08
- LIGHT DIRECTION FIXED
- NON DIMMABLE
- INTEGRATED
- 0°
- 0°
- OUTDOOR
- 220-240 V 50-60 Hz
- WARRANTY LIFE 50.000h
- WARRANTY 5 Years
- CE
- RoHS

MIKE FLOOR S	ref.	dimensions mm.	inst.	finish	optic options	power	CRI	K	eff. Lm/W	lumen max.	dim. opt.	tech opt.	watt max.	mA	sketch	
	K60700	.01 176x234x200	.FL	●	■	.ST	.8	80	.30	40	280	▲	◆	7	300	
				● ext-int finish .DG-DG				■		▲		◆				● K60700.01.FL.XX.ST.8.30

MIKE FLOOR M	ref.	dimensions mm.	inst.	finish	optic options	power	CRI	K	eff. Lm/W	lumen max.	dim. opt.	tech opt.	watt max.	mA	sketch	
	K60700	.02 176x234x500	.FL	●	■	.ST	.8	80	.30	40	280	▲	◆	7	300	
				● ext-int finish .DG-DG				■		▲		◆				● K60700.02.FL.XX.ST.8.30

MIKE FLOOR L	ref.	dimensions mm.	inst.	finish	optic options	power	CRI	K	eff. Lm/W	lumen max.	dim. opt.	tech opt.	watt max.	mA	sketch	
	K60700	.03 176x234x800	.FL	●	■	.ST	.8	80	.30	40	280	▲	◆	7	300	
				● ext-int finish .DG-DG				■		▲		◆				● K60700.03.FL.XX.ST.8.30

outdoor

FL



comet  
K60600

- ALUMINIUM
- IP65
- IK08
- LIGHT DIRECTION ADJUSTABLE
- NON DIMMABLE
- INTEGRATED
- 90°
- 0°
- OUTDOOR
- 220-240 V 50-60 Hz
- LIFE 50.000h
- WARRANTY 5 Years
- CE

Other installations / Otras instalaciones.

pag. 185 .WS

outdoor

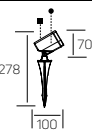
COMET	ref.	dimensions mm.	inst.	finish	optic options	power	CRI	K	eff. Lm/W	lumen max.	dim. opt.	tech. opt.	watt max.	mA	sketch
	<b>K60600</b>	<b>.01</b> 70x100x278	<b>.FL</b>	●	■	<b>.ST</b>	<b>.8</b> 80	<b>.30</b>	84	495	▲	◆	7	160	
				● ext-int finish <b>.DG-DG</b>	■			<b>.30</b>			▲	◆			<b>K60600.01.FL.XX.30.ST.8.30</b>

FL

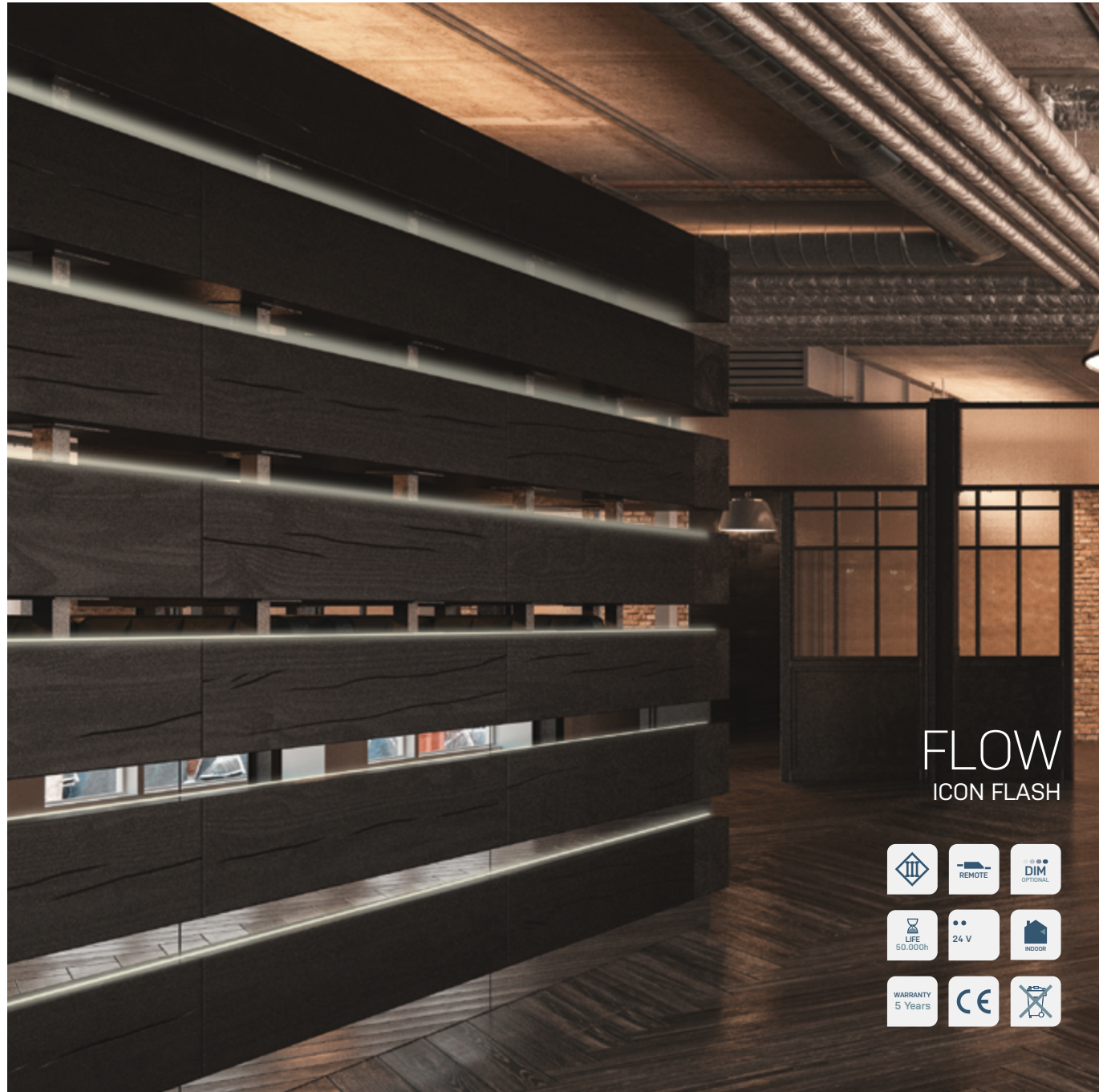

# FLOW ICON FLASH

- DIM OPTIMAL
- REMOTE
- LIFE 50,000h
- 24 V
- INDOOR
- WARRANTY 5 Years
- CE
- No disposal symbol

▲ K55006 flow

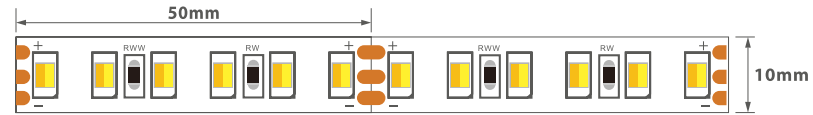

FLOW DW	ref.	K	lm / m*	W / m	LEDs / m	cut mm.	wide mm.	CRI	dimmm opt.	tech opt.
	<b>K55004.01.ST.8.00.DW</b>	<b>2700K-6500K</b>	<b>1380</b>	<b>20</b>	<b>120</b>	<b>50</b>	<b>10</b>	<b>.8</b> 80	<b>CONTROL</b>	<b>.00</b> <b>.DW</b>

\*Lumens/metter correspond to 3000k color temperature / Lumenes/metro analizados corresponde a la temperatura de color 3000K.

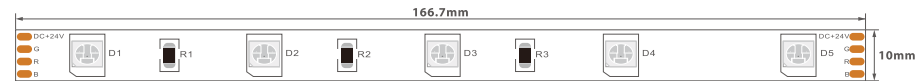

FLOW RGB	ref.	K	lm / m	W / m	LEDs / m	cut mm.	wide mm.	CRI	dimmm opt.	tech opt.
	<b>K55006.01.ST.8.00.RGB</b>	<b>RGB</b>	<b>868</b>	<b>7</b>	<b>60</b>	<b>166,7</b>	<b>10</b>	<b>.8</b> 80	<b>CONTROL</b>	<b>.00</b> <b>.RG</b>

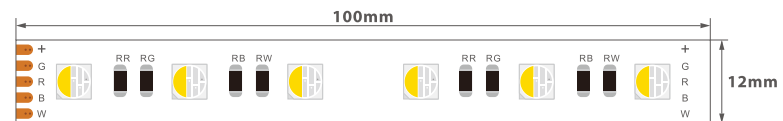

FLOW RGBW	ref.	K	lm / m	W / m	LEDs / m	cut mm.	wide mm.	CRI	dimmm opt.	tech opt.
	<b>K55007.01.ST.8.00.RGBW</b>	<b>RGB 3000K</b>	<b>870</b>	<b>18</b>	<b>60</b>	<b>100</b>	<b>12</b>	<b>.8</b> 80	<b>CONTROL</b>	<b>.00</b> <b>.RG</b>

Product contains 3M self-adhesive tape on the back for easy mounting on different surfaces. It is delivered in 5m rolls, for other lengths an additional cutting cost that includes the electrical connection will be applied. Please indicate in your order adding Ref. KPCUT. El producto contiene cinta autoadhesiva de 3M en la parte posterior para facilitar el montaje en diferentes superficies. Se sirve en rollos de 5 m, para otras longitudes se aplicará un coste adicional de corte que incluirá la conexión. ( Ref. KPCUT), esto deberá indicarse claramente en el pedido.



# flow

Product contains 3M self-adhesive tape on the back for easy mounting on different surfaces. It is delivered in 5m rolls, for other lengths an additional cutting cost that includes the electrical connection will be applied. Please indicate in your order adding Ref: KPCUT.  
El producto contiene cinta autoadhesiva de 3M en la parte posterior para facilitar el montaje en diferentes superficies. Se sirve en rollos de 5 m, para otras longitudes se aplicará un coste adicional de corte que incluirá la conexión. ( Ref: KPCUT), esto deberá indicarse claramente en el pedido.

Price is per 1m. Precio es por 1m.

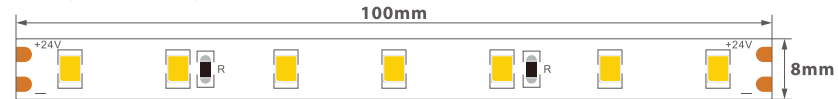

FLOW	ref.	K	lm / m	W / m	lm / W	LEDs / m	cut mm.	wide mm.	CRI		dimmm opt.
	<b>K55010.11.ST.9.XX</b>	<b>.27</b>	550	5	85	70	100	8	<b>.9</b>	90	<b>.DA</b>
		<b>.30</b>	590		91						<b>.PU</b>
		<b>.40</b>	631		97						<b>.D1</b>
		<b>.22</b>	510		79						

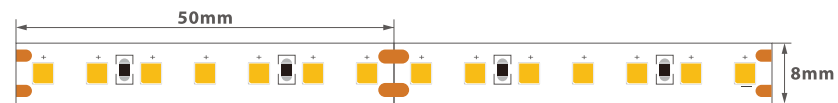

FLOW	ref.	K	lm / m	W / m	lm / W	LEDs / m	cut mm.	wide mm.	CRI		dimmm opt.
	<b>K55010.12.ST.9.XX</b>	<b>.27</b>	1090	10	87	140	50	8	<b>.9</b>	90	<b>.DA</b>
		<b>.30</b>	1140		91						<b>.PU</b>
		<b>.40</b>	1193		95						<b>.D1</b>

## ICON FLASH

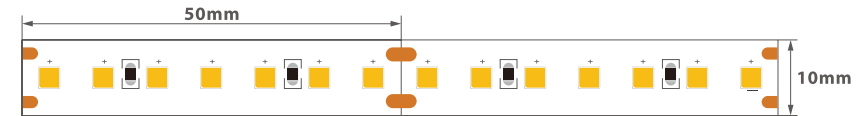

FLOW	ref.	K	lm / m	W / m	lm / W	LEDs / m	cut mm.	wide mm.	CRI		dimmm opt.
	<b>K55010.21.ST.9.XX</b>	<b>.27</b>	1530	15	90	140	50	10	<b>.9</b>	90	<b>.DA</b>
		<b>.30</b>	1630		95						<b>.PU</b>
		<b>.40</b>	1735		102						<b>.D1</b>

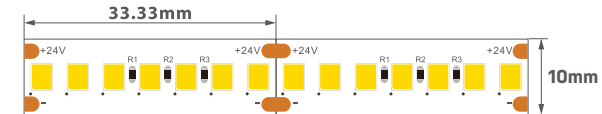

FLOW	ref.	K	lm / m	W / m	lm / W	LEDs / m	cut mm.	wide mm.	CRI		dimmm opt.
	<b>K55010.13.ST.9.XX</b>	<b>.27</b>	2080	20	88	210	33,3	10	<b>.9</b>	90	<b>.DA</b>
		<b>.30</b>	2130		91						<b>.PU</b>
		<b>.40</b>	2200		94						<b>.D1</b>

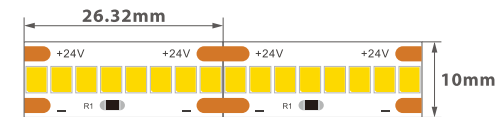

FLOW	ref.	K	lm / m	W / m	lm / W	LEDs / m	cut mm.	wide mm.	CRI		dimmm opt.
	<b>K55010.22.ST.9.XX</b>	<b>.27</b>	3602	30	104	304	26,3 mm.	10	<b>.9</b>	90	<b>.DA</b>
		<b>.30</b>	3700		107						<b>.PU</b>
		<b>.40</b>	3800		110						<b>.D1</b>

# flow IP65

Product contains 3M self-adhesive tape on the back for easy mounting on different surfaces. It is delivered in 5m rolls, for other lengths an additional cutting cost that includes the electrical connection will be applied. Please indicate in your order adding Ref. KPCUT.  
El producto contiene cinta autoadhesiva de 3M en la parte posterior para facilitar el montaje en diferentes superficies. Se sirve en rollos de 5 m, para otras longitudes se aplicará un coste adicional de corte que incluirá la conexión. ( Ref. KPCUT), esto deberá indicarse claramente en el pedido.

Price is per 1m. Precio es por 1m.

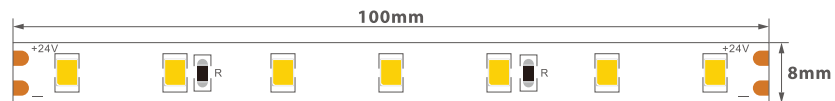

FLOW IP65	ref.	K	lm / m	W / m	lm / W	LEDs / m	cut mm.	wide mm.	CRI	dimmm opt.	
	<b>K55011.11.ST.9.XX</b>	.27	550	5	85	70	100	8	.9	90	.DA
		.30	590		91						.PU
		.40	631		97						.D1
		.22	510		79						

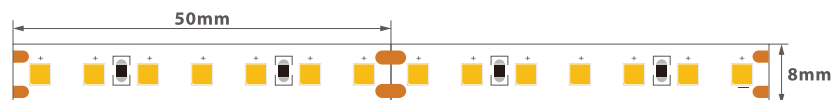

FLOW IP65	ref.	K	lm / m	W / m	lm / W	LEDs / m	cut mm.	wide mm.	CRI	dimmm opt.	
	<b>K55011.12.ST.9.XX</b>	.27	1090	10	87	140	50	8	.9	90	.DA
		.30	1140		91						.PU
		.40	1193		95						.D1

## ICON FLASH

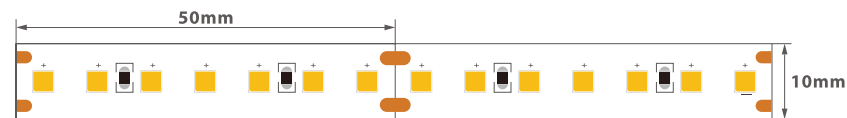

FLOW IP65	ref.	K	lm / m	W / m	lm / W	LEDs / m	cut mm.	wide mm.	CRI	dimmm opt.	
	<b>K55011.21.ST.9.XX</b>	.27	1530	15	90	140	50	10	.9	90	.DA
		.30	1630		95						.PU
		.40	1735		102						

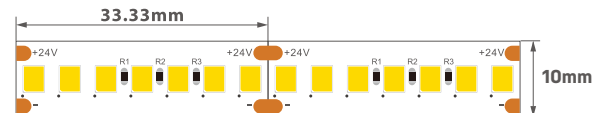

FLOW IP65	ref.	K	lm / m	W / m	lm / W	LEDs / m	cut mm.	wide mm.	CRI	dimmm opt.	
	<b>K55011.13.ST.9.XX</b>	.27	2080	20	88	210	33,3	10	.9	90	.DA
		.30	2130		91						.PU
		.40	2200		94						.D1

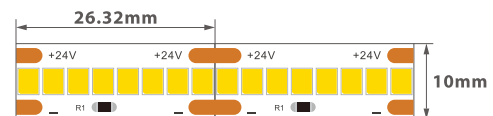

FLOW IP65	ref.	K	lm / m	W / m	lm / W	LEDs / m	cut mm.	wide mm.	CRI	dimmm opt.	
	<b>K55011.22.ST.9.XX</b>	.27	3602	30	104	304	26,3	10	.9	90	.DA
		.30	3700		107						.PU
		.40	3800		110						.D1



# Flow accesories accesorios Flow



## LED STRIPS DRIVERS ON/OFF EQUIPOS PARA TIRAS DE LED ON /OFF

KD57055	20W	153 x 41 x 32 mm	IP20	24V	ON/OFF
KD57056	30W	154 x 42 x 32 mm			
KD57057	60W	182 x 50 x 30 mm			
KD57058	75W	180 x 50 x 30 mm			
KD57059	120W	300 x 40 x 30 mm	IP67		
KD57060	150W	205 x 65 x 35 mm			

It is recommended to use a driver per each 5 m. of LED strip whose power should be the result of the following formula:

$$\text{driver Power} = \text{LED strip Power (W/m)} \times \text{LED strip Length (m)} \times 1,10$$

Se recomienda usar un driver por cada 5 m. de tira LED y cuya potencia sea el resultado de la siguiente fórmula:

$$\text{Potencia driver} = \text{Potencia tira LED (W/m)} \times \text{Longitud tira LED (m)} \times 1,10$$

KD57061	25W	153 x 41 x 32 mm	IP20	24V	.DA .PU
KD57062	60W	154 x 42 x 32 mm			.DA .PU
KD57068	100W	205x 70 x 43 mm			.DA .PU
KD57069	150W	220 x 70 x 43 mm			.DA .PU
KD57064	30W	235 x 30 x 21 mm			.D1
KD57065*	60W	280 x 30 x 21.6 mm			.D1
KD57066*	100W	360 x 30.4 x 21.5 mm			.D1
KD57067*	150W	425 x 45 x 21.5 mm			.D1

KACBOXDRIVER	FLOW BOX DRIVER IP65	460 x 41 mm
--------------	----------------------	-------------

\* This driver requires a Flow box driver IP65 (KACBOXDRIVER)  
\* Este driver requiere ir dentro de una caja Flow box driver IP65 (KACBOXDRIVER)

## CONTROL CONTROLADORES

KACDW	FLOW CONTROLADOR DW	144W	12V	83 x 79 x 33 mm.	IP20	compatible with FLOW DW LED strip compatible con tira de LED FLOW DW
		288W	24V			
KACRGB	FLOW CONTROLADOR RGB	216W	12V	83 x 79 x 33 mm.		compatible with FLOW RGB LED strip compatible con tira de LED FLOW RGB
		432W	24V			
KACRGB-DW	FLOW CONTROLADOR RGBW	216W	12V	85 x 45 x 22 mm.		compatible with FLOW RGBW LED strip compatible con tira de LED FLOW RGBW
		432W	24V			
KACWIFI	FLOW CONTROLADOR WIFI	96W	12V	53 x 24 x 11 mm.		compatible with all FLOW LED strips compatible con todos los modelos de tira de LED FLOW
		192W	24V			

Control requires an on/off driver  
El controlador necesita ir acompañado de un driver on/off.

# profiles

LED STRIPS



Profiles and diffusers are served with a maximum length of two meters, for other lengths other than 2 meters an additional cost will be applied to cutting only the profile, only the diffuser or the profile together with the diffuser (Ref. KPCUT)

Los perfiles y difusores se sirven con una longitud máxima de dos metros, para otras longitudes distintas a 2 metros se aplicará un coste al corte solo del perfil, solo del difusor o al perfil junto con el difusor (Ref. KPCUT)

FLOW PROFILE 01	components	ref.	finish		dimensions
	PROFILE	KP55001.01.SR	.ALUMN	.WH-WH	
	DIFUSSER	KPD55001.01.SR	.OP	.OT	
	COVER	KPC55001.01.SR	.ALUMN	.WH-WH	
	COVER HOLE	KPC55001H.01.SR	.ALUMN	.WH-WH	

FLOW PROFILE 02	components	ref.	finish		dimensions
	PROFILE	KP55002.01.SR	.ALUMN	.WH-WH	
	DIFUSSER	KPD55002.01.SR	.OP	.OT	
	COVER	KPC55002.01.SR	.ALUMN	.WH-WH	
	COVER HOLE	KPC55002H.01.SR	.ALUMN	.WH-WH	

FLOW PROFILE 04	components	ref.	finish		dimensions
	PROFILE	KP55004.01.SR	.ALUMN	.BK-BK	
	DIFUSSER	KPD55004.01.SR	.OP	.OT	
	COVER	KPC55004.01.SR	.ALUMN	.BK-BK	
	COVER HOLE	KPC55004H.01.SR	.ALUMN	.BK-BK	

FLOW PROFILE 03	components	ref.	finish		dimensions
	PROFILE	KP55003.01.TR	.ALUMN		
	DIFUSSER	KPD55003.01.TR	.OP	.OT	
	COVER	KPC55003.01.TR	.ALUMN		
	COVER HOLE	KPC55003H.01.TR	.ALUMN		

FLOW PROFILE 05	components	ref.	finish		dimensions
	PROFILE	KP55005.01.RF	.ALUMN	.WH-WH	
	DIFUSSER	KPD55005.01.RF	.OP	.OT	
	COVER	KPC55005.01.RF	.ALUMN	.WH-WH	
	COVER HOLE	KPC55005H.01.RF	.ALUMN	.WH-WH	

FLOW PROFILE 06*	components	ref.	finish		dimensions
	PROFILE	KP55006.01.TR	.ALUMN	.WH-WH	
	DIFUSSER	KPD55006.01.TR	.OP	.OT	
	COVER	KPC55006.01.TR	.ALUMN	.WH-WH	
	COVER HOLE	KPC55006H.01.TR	.ALUMN	.WH-WH	

# GU LAMPS

KLB



**moon totem**  
K50133  
pag.35



**moon**  
K50110  
pag.100



**moon daisy**  
K50132  
pag.101



**ozone**  
K50112  
pag.103



**sun**  
K50140  
pag.104



**sun dawn**  
K50141  
pag.105



**venus**  
K50111  
pag.106



**venus dash**  
K50131  
pag.107



**venus dip IP65**  
K50113  
pag.108



**venus dot**  
K50130  
pag.109



**ozone sat**  
K50126  
pag.136



**ozone sat sq**  
K50125  
pag.139



**focus**  
K51200  
pag.152

KLB	ref.	dimensions mm.	finish	optic options	K	eff. Lm/W	lumen max.
	<b>KLB</b>	Ø50x50	●	■	<b>.30</b>	100	600
					<b>.40</b>	117	700
	<b>.BK-BK   .WH-WH</b>		<b>.25</b>		<b>KLB.XX.XX.XX</b>		



TECHNICAL  
INFO

# TECHNICAL INFO INFO TÉCNICA

Icon Flash

Abbreviations  
Abreviaturas

Color Chart  
Carta de Color

Glossary  
Glosario

## ICON FLASH ICON FLASH



Rectangular cut.  
Agujero de corte rectangular.



Luminaire not suitable to be covered with thermal insulating material.  
Luminaria no adecuada para cubrirse con material aislante térmico.



Surface luminaire suitable for installation on normally inflammable surfaces.  
Luminaria superficial adecuada para montaje en superficies normalmente inflamables.



Recessed luminaire suitable for installation on normally inflammable surfaces.  
Luminaria empotrada adecuada para montaje en superficies normalmente inflamables.



Luminaire with two different IP degrees of protection at the top and bottom.  
Grado IP de la luminaria tanto por la parte superior e inferior del empotramiento de la luminaria.



AC input for luminaire is 220-240V / 50-60Hz.  
Input AC de luminaria a 220-240V/50-60Hz.



DC output for luminaire is 24 V DC.  
Output DC de trabajo de luminaria a 24V DC



Driver remote.  
Driver remoto.



Driver integrated inside the luminaire.  
Driver integrado dentro de la luminaria.



Luminaire has dimmable options on request.  
La luminaria tiene opciones de regulación.



Luminaire can not be dimmable.  
La luminaria no se puede regular.



Modular Ceiling  
Techos modulares



Only for indoor use.  
Solo para uso interior.



Outdoor use.  
Uso exterior.



Indoor / outdoor use.  
Uso interior / exterior.



According to applicable European directives.  
Conforme a las directivas europeas aplicables.



**Class I:** Luminaire in which the protection against electric shocks falls into a protective conductor grounded.  
**Class I:** Luminaria en que la protección contra los choques eléctricos recae a un conductor de protección puesto a tierra.



**Class II:** Luminaire in which the protection against electric shocks includes additional safety features such as double insulation or reinforced insulation.  
**Class II:** Luminaria en que la protección contra los choques eléctricos, comprende medidas de seguridad suplementarias, tales como el doble aislamiento o el aislamiento reforzado.



**Class III:** Luminaire in which the protection against electric shocks falls on the power supply with very low safety voltage (SELV) and in which no voltages higher than the very low safety voltage are generated.  
**Class III:** luminaria en la que la protección contra los choques eléctricos recae en la alimentación con muy baja tensión de seguridad (MTBS) y en la que no se generan tensiones superiores a la muy baja tensión de seguridad.



GU10 Lampholder.  
Portalámparas GU10.

### TECHNICAL INFO



Warranty.  
Garantía.



Unified Glare Rating.  
Índice de Deslumbramiento Unificado.



Luminaire is made of aluminum.  
La luminaria está fabricada de aluminio.



Luminaire is made of aluminum and polycarbonate.  
La luminaria está fabricada de aluminio y policarbonato.



Luminaire is made of polycarbonate.  
La luminaria está fabricada de policarbonato.



Rotation degrees.  
Grados de giro.



Tilting degrees.  
Grados de basculación.



Protection rate against external mechanical impacts.  
Grado de resistencia contra golpes mecánicos externos.



Luminaire's Lifetime.  
Vida útil de la luminaria.



Lamp not included.  
Lámpara no incluida.



Light direction of luminaire is fixed.  
La dirección de luz de la luminaria es fija.



Light direction of luminaire is adjustable.  
La dirección de luz de la luminaria es direccionable.



Minimum safety distance between luminaire and ceiling.  
Distancia mínima de seguridad entre luminaria y techo.



Minimum safety distance between luminaire and wall.  
Distancia mínima de seguridad entre luminaria y pared.



Luminaire has motion detector.  
La luminaria tiene detector de movimiento.



Surface.  
Superficie.



Wall Surface.  
Aplique de pared.



Floor.  
Baliza.



Recessed with Frame.  
Empotrado con marco.



Wall Recessed.  
Empotrado en pared.



Tracklight.  
Proyector de carril.



Trimless.  
Empotrado sin marco.



Pendant.  
Colgante.



Luminaire with USB  
Luminaria con USB



At the end of its life, the product must be disposed separately from other waste, through appropriate recycling.  
La luminaria al final de su vida debe eliminarse por separado de los demás desechos mediante reciclaje adecuado.



Luminaire is compatible with honeycomb accessory (KACHC)  
La luminaria es compatible con el accesorio panel de abeja (KACHC)



Luminaire can be customized with the options in the color chart.  
La luminaria se puede personalizar con las opciones de la carta de color.



Honeycomb accesory compatible with below luminaires:  
**Accesorio panel de abeja compatible con las siguientes luminarias:**

luminaire ref.	honeycomb dimensions	honeycomb ref.
K51100.01	32 mm.	<b>KACHC.01</b>
K50110   K50113   K50130   K50131   K50132   K50133   K51100.02   K51200   K53270   K53271	42 mm.	<b>KACHC.02</b>
K50112   K50140   K50141   K50300.01   K51100.03	48 mm.	<b>KACHC.03</b>



Luminaires can be customized with the following options from color chart, otherwise they are delivered in white .WH-WH.  
 Please add code **COLORCOST.DIMENSIONS.XX** (e.g. **COLORCOST.01.GY**) to tailor your luminaire.  
 Luminarias personalizables con las siguientes opciones de la carta de color, de lo contrario se sirven en blanco .WH-WH. Por favor especifique código **COLORCOST.DIMENSIONS.XX** (ej. **COLORCOST.01.GY**) para personalizar su luminaria.

luminaire ref.	ext-int finish		color
K50522   K50523	.BK		<i>Black / Negro</i>
	.BM		<i>Blue Mint / Azul Menta</i>
	.BS		<i>Blue Stone / Azul Piedra</i>
	.BC		<i>Brown Coffee / Marrón Café</i>
	.CR		<i>Copper Rose / Cobre Rosado</i>
	.CB		<i>Coral Bronze / Bronce Coral</i>
	.DG		<i>Dark Gray / Gris Oscuro</i>
	.GC		<i>Gold Cava / Oro Cava</i>
	.GY		<i>Gray / Gris</i>
	.MG		<i>Military Green / Verde Militar</i>
	.VC		<i>Violet Chiffon / Violeta Chifón</i>
	.YM		<i>Yellow Mustard / Amarillo Mostaza</i>



COLOR CHART  
**GAMA DE COLORES**



INSTALLATION / INSTALACIÓN

- .FL** Floor / Baliza
- .PN** Pendant / Colgante
- .RF** Recessed with Frame / Empotrado con marco
- .SR** Surface / Superficie
- .TK** Tracklight / Proyector de carril
- .TR** Trimless / Empotrado
- .WR** Wall Recessed / Empotrado en pared
- .WS** Wall Surface / Aplique de pared

KELVIN DEGREES / GRADOS KELVIN

- .27** 2700K
- .30** 3000K
- .40** 4000K
- .50** 5000K
- .60** 6000K

OPTIC OPTIONS / OPCIONES ÓPTICAS

- .MP** Microprismatic / Microprismático
- .OP** Opal /Opal
- .SK** Sky /Cielo

TECHNICAL OPTIONS / OPCIONES TÉCNICAS

- .00 .RGB** RGB
- .00 .DW** Dynamic White / Blanco dinámico
- .01 K SELECT** Select one of three color temperatures (3000K-4000K-6000K) by switch / Selecciona una de las tres temperaturas de color (3000K-4000K-6000K) mediante switch

COLOR RENDERING INDEX | CRI

ÍNDICE DE REPRODUCCIÓN CROMÁTICA | CRI

- .8** 80
- .9** 90

POWER TYPE / TIPO DE POTENCIA

- .HI** High / Alta
- .ST** Standard / Estándar

DIMMABLE OPTIONS

OPCIONES DE REGULACIÓN

- .D1** 1..10V
- .DA** Dali
- .PC** Phase Cut / Corte de fase
- .PU** Push / Pulsador

EXTERNAL-INTERNAL FINISH

ACABADO EXTERIOR-INTERIOR

- .BK** Black / Negro
- .BM** Blue Mint / Azul Menta
- .BS** Blue Stone / Azul Piedra
- .BC** Brown Coffee / Marrón Café
- .CR** Copper Rose / Cobre Rosado
- .CB** Coral Bronze / Bronce Coral
- .DG** Dark Gray / Gris Oscuro
- .GL** Gold / Oro
- .GC** Gold Cava / Oro Cava
- .GY** Gray /Gris
- .MG** Military Green / Verde Militar
- .SB** Shiny Brown / Marrón brillo
- .VC** Violet Chiffon / Violeta Chifón
- .WH** White / Blanco
- .YM** Yellow Mustard / Amarillo Mostaza
- .ALUMN** Aluminium / Aluminio.

REF. Reference / Referencia

DIMENSIONS mm. Product dimensions (mm.)

Dimensiones de producto (mm.)

INST. Installation / Instalación

FINISH Color finish / Acabado de color

EXT-INT FINISH External-internal color finish

Acabado de color exterior-interior

OPTIC OPTIONS Optic options of luminaire

Opciones ópticas de la luminaria

POWER Power / Potencia

CRI Color rendering index

Índice de reproducción cromática

K Kelvin degrees / Grados Kelvin

EFF. Lm/W Efficacy (lumens/watts)

Eficacia (lúmenes/vatios)

LUMEN. MAX. Maximum lumen of luminaire

Lúmenes máximos de la luminaria

DIMM OPT. Dimming Options

Opciones de regulación

TECH OPT. Technical Options

Opciones técnicas

WATT MAX. Maximum watt of luminaire

Máximo potencia de la luminaria

mA Milliamperage / Miliamperaje

PRICE Manufacturer's retail suggested price (MRSP)

Precio de venta al público recomendado por el fabricante (PVP)

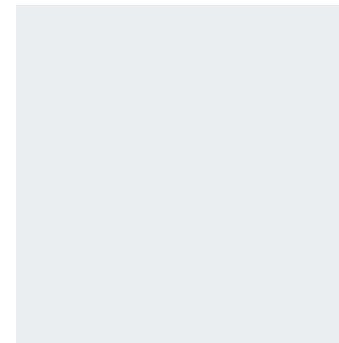
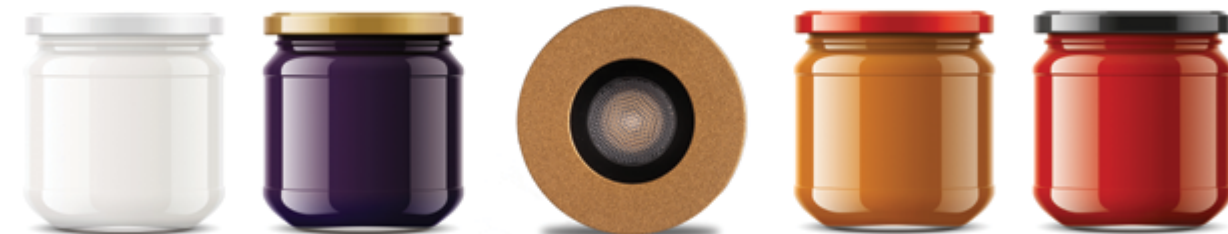

## IP DEGREE OF PROTECTION GRADO DE PROTECCIÓN IP

As IEC 60529 standard says, the IP protection degree specifies the different protection levels provided by the containers that protect the components in electrical or electronic equipment. The greater the IP protection degree, the more protected the equipment is. An IP XY protection degree indicates the following:

Según la Norma IEC 60529, el grado de protección IP especifica los diferentes niveles de protección aportados por los contenedores que resguardan los componentes de los equipos eléctricos o electrónicos. Cuanto mayor es el grado de protección IP, más protegido está el equipamiento. Un grado de protección IP XY indica lo siguiente:

**X: Describes the level of protection against dust and other particles / Describe el nivel de protección contra polvo y otras partículas**

X	Protection grade against dust / Grado de protección contra polvo
0	Without protection / Sin protección
1	Protected against solids bigger than 50 mm / Protegida contra sólidos de más de 50 mm
2	Protected against solids bigger than 12 mm / Protegida contra sólidos de más de 12 mm
3	Protected against solids bigger than 2,5 mm / Protegida contra sólidos de más de 2,5 mm
4	Protected against solids bigger than 1 mm / Protegida contra sólidos de más de 1 mm
5	Protection against the entrance of dust / Protegida contra la entrada de polvo
6	Full protected against dust / Totalmente protegida del polvo

**Y: Describes the level against liquids / Describe el nivel de protección contra líquidos**

Y	Protection grade against liquids / Grado de protección contra líquidos
0	Without protection / Sin protección
1	Protected against drops of water falling vertically / Protegida contra la caída vertical de gotas de agua
2	Protected against drops of water falling at a maximum inclination of 15° Protegida contra la caída de gotas de agua con una inclinación máxima de 15°
3	Protected against sprayed water / Protegida contra agua pulverizada
4	Protected against splashes of water / Protegida contra las proyecciones de agua
5	Protected against jets of water / Protegida contra los chorros de agua
6	Protected against high tide / Protegida contra mar gruesa
7	Protected against plunging effects / Protegida contra los efectos de la inmersión
8	Protected against long immersion / Protegida contra la inmersión prolongada

\*Specialized cleaning procedures are not covered by IP ratings. It is recommended that manufacturers provide, if necessary, adequate information regarding cleaning procedures. This is in accordance with the recommendations contained in IEC 60529 for special cleaning procedures.

\*Los procedimientos especializados de limpieza no están cubiertos por los grados de protección IP. Se recomienda que los fabricantes suministren, si es necesario, una adecuada información en lo referente a los procedimientos de limpieza. Esto está de acuerdo con las recomendaciones contenidas en la Norma IEC 60529 para los procedimientos de limpieza especiales.

## IK DEGREE GRADO IK

The degree of protection IK is an international numerical classification for the degrees of protection provided by enclosures of electrical equipment against external mechanical impacts. This provides a means of specifying the ability of an enclosure to protect its contents from shock.

El grado de protección IK es una clasificación numérica internacional para los grados de protección proporcionados por las envolventes de materiales eléctricos contra los impactos mecánicos externos. Esto proporciona un medio para especificar la capacidad de un recinto para proteger su contenido de los golpes.

IK DEGREE GRADO IK	PROTECTION AGAINST EXTERNAL MECHANICAL IMPACTS PROTECCIÓN CONTRA IMPACTOS MECÁNICOS EXTERNOS	DESCRIPTION DESCRIPCIÓN
IK00	No protection / Sin proteger	
IK01	Protected against 0.150J impact. Protegido contra impacto de energía 0.150J.	Resistant against an impact of an object of 200 grs launched from a distance of 7.5 cm. Resistente contra un impacto de un objeto de 200 grs lanzado desde una distancia de 7,5 cm.
IK02	Protected against 0.200J impact. Protegido contra impacto de energía 0.200J.	Resistant against an impact of an object of 200 grs launched from a distance of 10 cm. Resistente contra un impacto de un objeto de 200 grs lanzado desde una distancia de 10 cm.
IK03	Protected against 0.350J impact. Protegido contra impacto de energía 0.350J.	Resistant against an impact of an object of 200 grs launched from a distance of 17.5 cm. Resistente contra un impacto de un objeto de 200 grs lanzado desde una distancia de 17,5 cm.
IK04	Protected against 0.500J impact. Protegido contra impacto de energía 0.500J.	Resistant against an impact of an object of 200 grs launched from a distance of 25 cm. Resistente contra un impacto de un objeto de 200 grs lanzado desde una distancia de 25 cm.
IK05	Protected against 0.700J impact. Protegido contra impacto de energía 0.700J.	Resistant against an impact of an object of 200 grs launched from a distance of 35 cm. Resistente contra un impacto de un objeto de 200 grs lanzado desde una distancia de 35 cm.
IK06	Protected against 1.00J impact. Protegido contra impacto de energía 1.00J.	Resistant against an impact of an object of 500 grs launched from a distance of 20 cm. Resistente contra un impacto de un objeto de 500 grs lanzado desde una distancia de 20 cm.
IK07	Protected against 2.00J impact. Protegido contra impacto de energía 2.00J.	Resistant against an impact of an object of 500 grs launched from a distance of 40 cm. Resistente contra un impacto de un objeto de 500 grs lanzado desde una distancia de 40 cm.
IK08	Protected against 5.00J impact. Protegido contra impacto de energía 5.00J.	Resistant against an impact of an object of 1,7 kg launched from a distance of 29,5 cm. Resistente contra un impacto de un objeto de 1,7 kg lanzado desde una distancia de 29,5 cm.
IK09	Protected against 10.00J impact. Protegido contra impacto de energía 10.00J.	Resistant against an impact of an object of 5 kg launched from a distance of 20 cm. Resistente contra un impacto de un objeto de 5 kg lanzado desde una distancia de 20 cm.
IK10	Protected against 20.00J impact. Protegido contra impacto de energía 20.00J.	Resistant against an impact of an object of 5 kg launched from a distance of 40 cm. Resistente contra un impacto de un objeto de 5 kg lanzado desde una distancia de 40 cm.

## DIMMABLE OPTIONS OPCIONES DE REGULACIÓN

They allow us to reduce the luminous flux in places where it is not always necessary to use the 100%. Nos permiten reducir el flujo luminoso en lugares donde no es siempre necesario el empleo del 100%.

Dimmable driver for some models needs to be remot. This is indicated on its corresponding catalogue page. El driver dimmable para algunos modelos se tiene que instalar en remoto y así se indica en su página correspondiente del catálogo.

In addition, please note that some dimming options require the combination of a minimum of luminaires as it is indicated in its corresponding catalogue page. Check with support team for other dimming options. Algunos productos necesitan la combinación de un mínimo de luminarias en algunas opciones de regulación. (Ver leyenda en su página correspondiente). Consulte con el equipo de soporte para otras opciones de regulación.

### 1.10V

Continuous regulation of the luminous flux from 1 to 100% by means of an analogue signal to the equipment over an additional two-wire control line. The analogic signal has a direct voltage value from minimum to maximum.

Regulación continua del flujo luminoso entre el 1 y el 100% mediante una señal analógica que llega a los equipos a través de una línea de control adicional de dos hilos. La señal analógica tiene un valor de tensión continua que va desde el mínimo hasta el máximo.

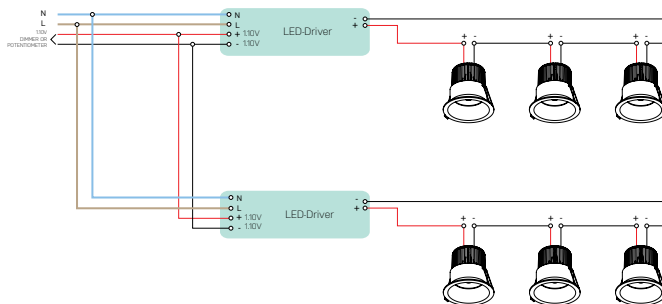

Always respect polarity of 1.10V signal

### PHASE CUT / CORTE DE FASE

This type of regulation is accomplished without any feed for additional control wire. It involves connecting a regulator in series between one of the mains wire and the equipment. The regulator cuts part of the mains voltage sinusoidal waveform to a greater or lesser extent in order to regulate luminous flux from 5% to 100%

Este tipo de regulación se realiza sin necesidad de una línea de control adicional, conectando un regulador en serie entre la línea de alimentación y el equipo. El regulador recorta parte de la onda sinusoidal de la tensión de red en mayor o menor medida para obtener una regulación de flujo lumínico entre 5-100%.

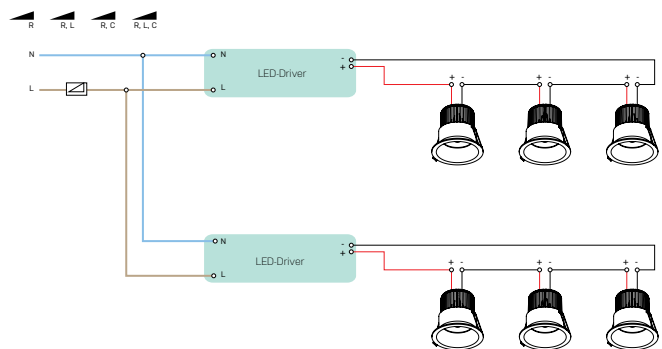

### PUSH / PULSADOR

Regulation via a single push button. Depending on how long the button is pressed it is possible to switch the light on or off or dim it. Switching the light on or off is done by short "click". If the button is pressed for a longer time it is possible to dim the luminous flux between the minimum and maximum level. Only use open push button with no warning pilot.

Regulación mediante un único botón pulsador. Dependiendo de la duración de la pulsación, es posible encender, apagar o regular la luz. Se apaga y enciende mediante un corto "clic". Si se mantiene el botón pulsado el flujo luminoso variará entre el nivel mínimo y máximo. La opción de pulsador no puede tener piloto de encendido.

#### SINGLE DIMM CHANNEL · REGULABLE MEDIANTE PULSADOR · SIMPLE

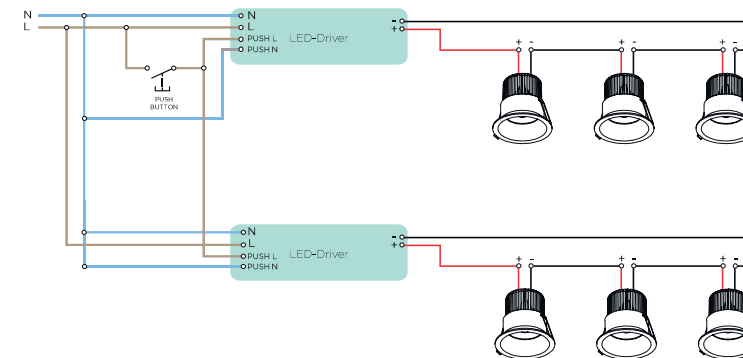

#### MASTER SLAVE WITH SYNCHRONISATION CABLE · REGULABLE MEDIANTE PULSADOR · MASTER

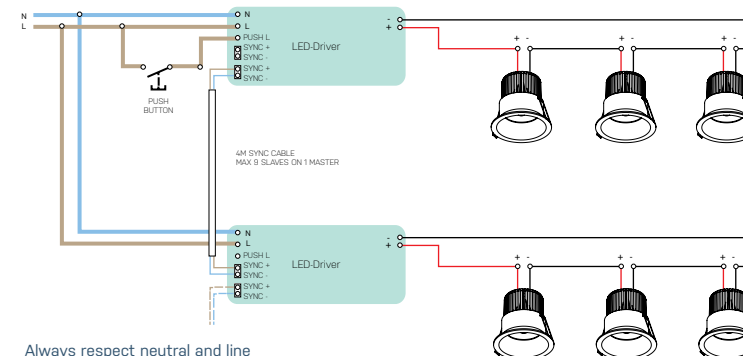

### DALI

Digital Addressable Lighting Interface. A completely digital control for switching and dimming lamps (or other electric devices) or a groups of them depending on a programmable device. This is an international standard system in accordance with IEC 62386, which ensures compatibility and interchangeability between different manufacturers' equipment.

Interfaz de direccionamiento digital de la iluminación. Un sistema completamente digital para el control del encendido y la regulación de las lámparas (u otros aparatos eléctricos) o grupo de ellas dependiendo de un dispositivo programable. Este sistema es un estándar internacional, de acuerdo a la norma IEC 62386, que asegura la compatibilidad e intercambiabilidad entre equipos de diferentes fabricantes.

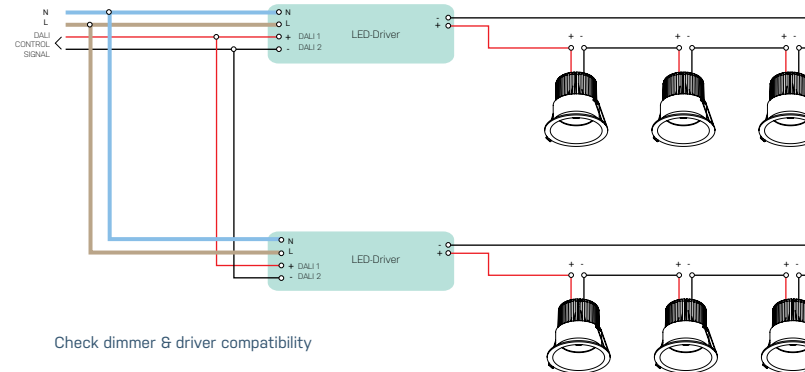

Check dimmer & driver compatibility

TECHNICAL  
INFO

## TECHNICAL OPTIONS OPCIONES TÉCNICAS

**DW** (Dynamic White, dynamic white). Color temperature control tunable, from warm to cool white.

**DW** (Dynamic White, blanco dinámico). Control variable de la temperatura de color, desde luz blanca cálida, hasta blanco frío.

**RGB** (Red -Green-Blue). Chromatic model through which various shades are created from the sum of different amounts of the primary additive colors. In led strips, the colors and their intensity are both adjustable by RF (radio-frequency) control.

**RGB** (Rojo-Verde-Azul). Modelo cromático mediante el que se crean las diferentes tonalidades a partir de la suma de distintas cantidades de los colores aditivos primarios.

En tiras de led son regulables tanto los colores como su intensidad mediante mando RF (radio-frecuencia).

**RGBW** (Red -Green-Blue-White). In addition to reproducing various colors and shades, a white light diode is added to obtain the different color combinations. Colors and their intensity are both adjustable by RF (radio-frequency) control.

**RGBW** (Rojo-Verde-Azul-Blanco). Además de reproducir los distintos colores y tonalidades, se añade un diodo de luz blanca para obtener las distintas combinaciones de color. Regulable mediante mando RF tanto los colores como la intensidad de los mismos.

## LUMEN LUMEN

The lumen (lm) is the unit to measure the luminous flux, meaning the total power of the visible light, emitted by radiation sources.

Product lumen analysis has been performed with models in white finish. For all luminaires with different color finishes, there might be a max. 15% value reduction. And lumens watts have been calculated taking into account the power of the system (LED + driver).

El lumen (lm) es la unidad de medida para medir el flujo luminoso, siendo este la medida de la potencia total de la luz visible, emitida por las fuentes de radiación.

Todas las mediciones lumínicas se han realizado en el producto acabado en blanco. Para todas las luminarias con diferentes acabados de color, puede haber una reducción del rendimiento lumínico de un 15% (máximo). Y los lúmenes watos se han calculado teniendo en cuenta la potencia del sistema (LED + driver)

## COLOR TEMPERATURE TEMPERATURA DE COLOR

Color temperature is measured in Kelvin degrees (K). When the color temperature is low, 2700-3000K, a warm white color is obtained (Yellowish color), and the higher the color temperature is, the light seems colder (Bluish color). Cold white, has a 5000-6500K temperature.

La temperatura de color se mide en grados Kelvin y se refiere a las distintas tonalidades que puede tener una luz. A baja temperatura de color, 2700-3000K, se obtiene un color blanco cálido (color amarillento), y cuanto más alta sea la temperatura de color, la luz parece más fría (color azulado). El blanco frío, tiene una temperatura de 5000-6500K.

## CRI

Color rendering index (CRI) is a quantitative measure that assesses the ability of a light source to faithfully reproduce the objects colors.

El índice de reproducción cromática (IRC) es una medida cuantitativa que valora la capacidad que tiene una fuente de luz de reproducir fielmente los colores de los objetos.

## OPTIC OPTIONS OPCIONES ÓPTICAS

**Beam angle** defines the area where the lamp radiates at least half (50%) of its maximum luminous intensity. Beam angle has a tolerance of plus/minus 2 degrees.

**Ángulo del haz de la luz**, se refiere al ángulo de la luz de una fuente luminosa medido desde el punto con más intensidad hasta el punto en el que la luminosidad desciende un 50% respecto a ese máximo. El ángulo de apertura tiene una tolerancia de más menos 2 grados.

**Diffuser** is a screen that encloses the lamp that diffuses the beam angle preventing glare. The finishes of the diffusers in this collection are microprismatic (MP), opal (.OP) and Sky/ decorative (.SK in some models).

**Difusor** es una pantalla que encierra la lámpara que difunde el haz de luz y evita el deslumbramiento. Los acabados de los difusores en esta colección son microprismático (MP), opal (.OP) y Sky/ decorativo (.SK en algunos modelos).

**Lampholder** is a device which mechanically supports and provides electrical connections for a compatible electric lamp.

**Portalámparas** es un dispositivo que soporta mecánicamente y proporciona conexiones eléctricas para una bombilla compatible.

## REFLECTOR / REFLECTOR:

Metallic or plastic component which allows redirect the light beam improving luminarie efficiency. Depending on degree of openness, light beam amplitude is adjusted, in othe words, a lower angle of reflection there is a lower light beam amplitude, focusing light at a certain point.

Componente metálico o plástico que permite redirigir el haz de luz mejorando considerablemente el rendimiento de la luminaria. Según el grado de apertura regulamos la amplitud del haz de luz, de forma que a menor ángulo de reflexión obtenemos una menor amplitud de dicho haz, concentrando la luz en un determinado punto.

## EMERGENCY KIT / KIT DE EMERGENCIA:

The emergency kit allows low lighting to be maintained for a specified time in the event of a power failure. It consist of a control device as well as a Ni/Cd battery that lasts between 1 and 3 hours (see ref. **KACKITLED1H** and ref. **KACKITLED3H**) depending on the equipment. Please note that Kohl Lighting luminaires are not in any case, emergency luminaires approved according to the UNE-60598-2.22 standard. Check with the sales team to find out the type of kit compatible with the selected luminaire.

El kit de cortesía (emergencia) permite mantener una iluminación reducida durante un tiempo determinado en caso de fallo de suministro eléctrico. Están formados por un dispositivo de control así como una batería Ni/Cd que dura entre 1 y 3 horas (ver ref. **KACKITLED1H** y ref. **KACKITLED3H**) dependiendo del equipo. Las luminarias de Kohl Lighting no son en ningún caso, luminarias de emergencia homologadas según norma UNE-60598-2.22. Consulta con el equipo comercial para saber el tipo de kit compatible con la luminaria seleccionada.

## PROTECTION CLASSES AGAINST ELECTRIC SHOCKS CLASES DE PROTECCIÓN CONTRA CHOQUES ELÉCTRICOS

According to the type of protection they offer against electric shocks, Kohl Lighting light fittings are classified as:

**Class I, Class II and Class III.**

Las luminarias de Kohl Lighting se clasifican en función de su tipo de protección contra los choques eléctricos, en:

**Clase I, Clase II y Clase III.**



**Class I:** Light fittings in which protection against electric shocks does not depend solely on the mains insulation, but instead contain an extra safety measure in the form of a circuit from the accessible conductive parts with an grounded protective conductor forming part of the installation's fixed wiring, so that the accessible conductive parts do not become dangerous should there be a defect in the mains insulation. Ground conductor is colored green&yellow in most countries, and just green in the U.S., Canada and Japan.

**Clase I:** Luminarias en la que la protección contra los choques eléctricos no recae exclusivamente sobre el aislamiento principal, sino que comprende una medida de seguridad suplementaria bajo la forma de medios de conexión de las partes conductoras accesibles con un conductor de protección puesto a tierra, formando parte del cableado fijo de la instalación, de tal manera que las partes conductoras accesibles no puedan llegar a ser peligrosas, en caso de defecto del aislamiento principal. La toma tierra es de color amarillo y verde en la mayoría de los países, y verde en los Estados Unidos, Canadá y Japón.



**Class II:** A Class II or double insulated electrical appliance is one which has been designed in such a way that it does not require a safety connection to electrical ground. The basic requirement is that no single failure can result in dangerous voltage becoming exposed so that it might cause an electric shock and that this is achieved without relying on an earthed metal casing. This is achieved having two layers of insulating material surrounding live parts or by using reinforced insulation.

**Clase II:** Dispositivo de Clase II o aparato con doble aislamiento eléctrico es uno que ha sido diseñado de tal forma que no requiere una toma a tierra de seguridad eléctrica. El requisito básico es que un fallo simple no puede dar lugar a tensiones peligrosas que puedan causar una descarga eléctrica. Esto se consigue mediante dos capas de material aislante rodeando las partes con tensiones peligrosas o utilizando un aislamiento reforzado.



**Class III:** Luminaire in which the protection against electric shocks falls on the power supply with very low safety voltage (SELV) and in which no voltages higher than the very low safety voltage are generated.

**Clase III:** Luminaria en la que la protección contra los choques eléctricos recae en la alimentación con muy baja tensión de seguridad (MTBS) y en la que no se generan tensiones superiores a la muy baja tensión de seguridad.



general  
sales  
conditions

**GENERAL TERMS AND CONDITIONS OF SALE**

All orders must be placed with KOHL Lighting in writing by email, and customers hereby accept the terms and conditions detailed below. Goods supplied by the Company shall remain the property of KOHL Lighting until payment is received, even if the goods have been sold to a third party. Delivery times are approximate and non-binding. KOHL Lighting will not accept claims for damages due to late delivery. KOHL Lighting reserves the right to amend, supplement or delete, without prior warning, the characteristics or designs of the products in this catalogue, as well as the corresponding prices. Therefore, customers are advised to contact KOHL Lighting directly for the latest information. KOHL Lighting is not responsible for any issues caused by the loss or damage of goods during transportation by the carrier. In accordance with Article 1 of Royal Decree 5/1997 of 14 January, complaint forms are available to our customers at the Company's registered office.

**CANCELLING AN ORDER**

Orders must be cancelled in writing and sent to KOHL Lighting by email. If the order has already been dispatched, please request a refund, in accordance with the terms and conditions detailed in the following section.

**RETURNING GOODS**

KOHL Lighting reserves the right to accept or reject return requests received. Returns must be made within 2 weeks of the invoice date, and a minimum depreciation rate of 5% will be applied to cover handling costs. Depending on the state of conservation of the luminaire, this percentage might be increased.

**RETURN TERMS AND CONDITIONS**

Return requests must be made in writing by email.

Please send all returns correspondence to the following email address: [info@kohl-lighting.com](mailto:info@kohl-lighting.com), stating, at the very least, the reason for the return, article reference number(s), quantity, item condition, date and invoice number.

If the return is authorised: The item must be returned in its original packaging and in perfect condition.

KOHL Lighting must receive the goods within a maximum of 10 days after the return has been authorised.

Any costs for returning the goods are the responsibility of the customer.

Returned goods will not be accepted in the case of discontinued or customised items any RAL other than black and white (manufactured specifically for the customer).

Please send the item, together with the documentation required by the Sales Department, to the following address: Partida Madrigueres Sud, 63A, 03700 Dénia (Alicante), Spain.

**WARRANTY**

Kohl Lighting guarantees its luminaires, as well as the equipment it distributes.

Upon establishment of the legal warranty, Kohl Lighting extends this warranty to cover manufacturing defects of the supplied luminaires for a period of 5 years from the invoice date. The determination of the product defect will be made at the sole discretion of Kohl Lighting, considering the overall performance of the product.

A decrease in light flux is a natural phenomenon throughout the LED's lifespan and is, therefore, not covered by the warranty.

**WARRANTY TERMS & CONDITIONS**

The limited conventional warranty is applicable only when:

1. The products are stored, installed, used, and maintained according to the technical specifications indicated on the product label (with special reference to voltage and operating temperature), the mounting instructions provided with it, and the information indicated in the respective catalogues or on the website.
2. Installation and maintenance tasks are performed by qualified technicians.
3. The reported defect affects the product's functionality.
4. The product has not been modified, altered, or treated in any way, with chemicals or otherwise, without prior written authorization from Kohl Lighting.
5. The product subject to warranty, if required by Kohl Lighting, must be available for further technical analysis for the necessary time to carry it out.
6. The defect has been communicated to Kohl Lighting in writing, via email, within 30 days from the date of receipt of the products (in the case of visible defects) or after their verification (in the case of hidden defects), including a photographic proof of the silver label on the product.

When sending material for a claim, it is essential that the accompanying documentation is attached to the package to avoid rejection of the material, and the reason for the claim, article reference, quantity, date, and invoice number must be indicated.

In the event that Kohl Lighting acknowledges the defect, it will choose at its discretion whether to repair or replace the defective product or component with the same product or an equivalent one, taking into account the technical evolution of the products and their components. Any technical intervention or replacement (partial or complete) of the product carried out under the warranty will not in any case give the right to an extension or renewal of the warranty beyond the stipulated years from the invoice date. The repair or replacement of the product recognized as defective by Kohl Lighting does not include the costs or expenses of materials or labour for disassembly, uninstallation, assembly, or installation. Kohl Lighting is not liable and will not reimburse any consequential loss or indirect, compensatory, or other damages suffered as a result of a defective product, such as, but not limited to, assembly costs, on-site installation costs, potential downtime costs, loss of profits, or the overall costs incurred by the purchasers.

**WARRANTY CANCELLATION CLAUSES**

This conventional warranty does not cover:

1. Labor costs and expenses, equipment and warehouse costs, or any other additional costs related to and/or derived from any necessary intervention to repair the defect (such as, but not limited to, assembly, disassembly, and transportation of defective equipment, to be repaired or new products, which will be at the exclusive expense of the customer).
2. Electrical components subject to wear and tear, comparable to consumables (such as lamps, batteries, sensors, etc.).
3. Interruptions resulting from impulsive disturbances (surges) exceeding the limits set by IEC 61000-4-5 and IEC 61547 standards.
4. Potential remote-control systems (photocells, telecontrol modules, gateways, etc.) not supplied with the luminaire.
5. Plastic parts, such as polycarbonate or PMMA, subject to natural aging.
6. Product damage due to negligence, transportation, and unforeseen and unpredictable events not within normal use conditions as per section 1.1 (e.g., electrical discharges and lightning strikes).
7. Products that have switched on for more than 6,500 hours per year.
8. Luminaires not used for its intended purpose.
9. Kohl Lighting shall not be held liable under any circumstances for accidental, compensatory, consequential, indirect, special, or other damages. Kohl Lighting's liability for a product defect is strictly limited to the actual amount paid for the defective product.

This conventional warranty is the only warranty provided by Kohl Lighting and is granted with the exclusion of other warranties, explicit or implied, such as, for example, warranties of merchantability or fitness for a particular purpose. The exclusive remedies available to the buyer for any non-conformity or defect in a product are those provided for by this warranty. The performance and lifespan of LEDs are not guaranteed if the luminaires have been installed in environments containing chemicals incompatible with the LEDs. Our technical department is available to verify the compatibility of the LEDs we use in relation to the substances present in the environment where the luminaires are installed.

**CONDICIONES GENERALES DE VENTA**

Todos los pedidos deberán ser formulados a KOHL Lighting por escrito vía e-mail, quedando aceptadas por el cliente las condiciones escritas a continuación. La mercancía suministrada por la Empresa, será propiedad de KOHL Lighting hasta el momento de pago, aunque dicha mercancía hubiese sido vendida a un tercero. Los plazos de entrega son aproximados y sin compromiso. KOHL Lighting no aceptará demandas por daños y perjuicios por la demora en la entrega. KOHL Lighting se reserva el derecho de modificar, complementar o suprimir, sin previo aviso, las características o diseños de los productos presentes en este catálogo, así como sus correspondientes tarifas. Por este motivo, se recomienda al cliente ponerse en contacto directamente con KOHL Lighting para obtener una información actualizada. KOHL Lighting no es responsable de los problemas generados por la pérdida o deterioro de la mercancía durante el transporte por agencia. De acuerdo con el art. 1 del RD 5/1997 14 Enero, existen a disposición de nuestros clientes hojas de reclamación en el domicilio social de la Empresa.

**ANULACIÓN DE PEDIDOS**

Las anulaciones de pedidos deberán hacerse por escrito y notificarse a KOHL Lighting vía e-mail. En caso de que el pedido ya se hubiese enviado, deberá solicitarse la devolución del mismo, acogiéndose a las condiciones detalladas en el siguiente apartado.

**DEVOLUCIÓN DE MERCANCÍA**

KOHL Lighting se reserva el derecho de aceptar o rechazar las solicitudes de devolución recibidas. En cualquier caso, se requerirá que no hayan transcurrido 15 días desde la fecha de la factura, y se aplicará una depreciación mínima del 5% por los costes de gestión. Dependiendo del estado de conservación de la luminaria, este porcentaje podrá incrementarse.

**CONDICIONES DE DEVOLUCIÓN**

La solicitud de devolución deberá formalizarse por escrito vía e-mail.

Las devoluciones deberán tramitarse en la siguiente dirección de correo: info@kohl-lighting.com.

Deberá informar a BPM Iluminación S.L por escrito del motivo de la devolución, referencia de artículo/s, cantidad, estado del material, fecha y número de factura.

Para presentar la solicitud deberá utilizarse el formulario de devolución habilitado por KOHL Lighting, donde se hará constar, al menos, el motivo de la devolución, referencia de artículo/s, cantidad, estado del material, fecha y número de factura.

En el caso de que la devolución fuera autorizada:

El material deberá devolverse en su embalaje original y en perfecto estado de conservación.

KOHL Lighting deberá recibir la mercancía en un plazo máximo de 10 días desde la autorización de la devolución.

Los portes de la devolución serán asumidos por el cliente.

No se admitirán devoluciones de mercancía en el caso de material descatalogado, material customizado, cualquier RAL distinto al blanco y negro (fabricado expresamente para el cliente).

Es imprescindible que la autorización de devolución se adjunte al bulto para que el material no sea rechazado.

El material deberá ser enviado, junto con la documentación requerida por el Área Comercial, a la siguiente dirección: Partida Madrigueros Sud, 63A, 03700 Dénia (Alicante).

**GARANTÍA**

Kohl Lighting garantiza sus luminarias, así como los equipos que distribuye.

Establecida la garantía legal, Kohl Lighting extiende dicha garantía sobre los defectos de fabricación de las luminarias suministradas durante un período de 5 años a partir de la fecha de la factura. La determinación del defecto del producto la realizará Kohl Lighting a su única discreción, considerando el rendimiento general dado por el producto. La depreciación del flujo luminoso es un fenómeno previsto durante la vida útil del LED y, por lo tanto, no está cubierto por la garantía.

**CONDICIONES DE GARANTÍA**

La garantía convencional limitada es aplicable solo cuando:

1. Los productos se almacenan, instalan, utilizan y mantienen según las especificaciones técnicas indicadas en el mercado del producto (con especial referencia a la tensión y a la temperatura de funcionamiento), a las instrucciones de montaje facilitadas con el mismo, a lo que se indica en los respectivos catálogos o en web.
2. La instalación y mantenimiento son ejecutados por personal técnico cualificado.
3. El defecto señalado perjudica las funciones del producto.
4. El producto no ha sido modificado, alterado o tratado en ningún modo, con agentes químicos o de cualquier otra manera, sin autorización previa y escrita de Kohl Lighting
5. El producto objeto de la garantía, si así lo requiere Kohl lighting, debe estar a disposición para más análisis técnicos durante el tiempo necesario para su realización.
6. El defecto ha sido comunicado a Kohl Lighting por escrito, mediante correo electrónico antes de 30 días a partir de la fecha de recepción de los productos (en caso de defectos aparentes) o tras su verificación (en caso de defectos no visibles) mediante el envío de una prueba fotográfica de la etiqueta plateada presente en el producto. Para las incidencias por roturas, referencias erróneas o cantidades incorrectas, dispone de un plazo de 10 días para su reclamación. La reclamación por roturas deberá quedar documentada en el justificante de entrega de la agencia de transporte.

En el envío del material de incidencia, es imprescindible que la documentación vaya adjunta al bulto para que el material no sea rechazado, e indicar el motivo de la incidencia, referencia de artículos, cantidad, fecha y número de factura.

En el caso de que Kohl Lighting reconozca el defecto, elegirá de manera discrecional si reparar o sustituir el producto o componente defectuoso con el mismo producto o con uno equivalente, teniendo en consideración la evolución técnica de los productos y la de sus componentes. Cualquier intervención técnica o sustitución (parcial o completa) del producto realizada en el marco de la garantía no dará derecho en ningún caso a una prórroga o renovación de la garantía más allá de los años estipulados a partir de la fecha de la factura. La reparación o sustitución del producto reconocido como defectuoso por Kohl Lighting no incluye los costes o gastos de material o de personal por el desmontaje, desinstalación, montaje o instalación. Kohl Lighting no es responsable y, por lo tanto, no reembolsará ninguna pérdida consecuenta o daño indirecto, compensatorio o de otra naturaleza sufrida a causa de un producto defectuoso, como, a modo de ejemplo y no exhaustivo, los costes de ensamblaje, los costes de instalación in situ, los posibles costes por parada de la planta, la pérdida de ganancias y los costes totales de los compradores.

**CLÁUSULAS DE ANULACIÓN DE LA GARANTÍA**

Esta garantía convencional no cubre:

1. Costes y gastos de mano de obra, costes y gastos de equipamiento y almacén, así como cualquier otro coste adicional relativo y/o derivado de cualquier intervención necesaria para reparar el defecto (tales como, pero no limitados a, costes/gastos de montaje, desmontaje y transporte de equipos defectuosos, a reparar o productos nuevos, que correrán a cargo exclusivo del cliente);
2. Componentes eléctricos sujetos a desgaste asimilables a consumibles (como lámparas, pilas, sensores, etc.);
3. Interrupciones resultantes de perturbaciones impulsivas (sobretensiones) superiores a los requisitos de la norma IEC 61000-4-5 y IEC 61547.
4. Posibles sistemas de control remoto (fotocélulas, módulos de telecontrol, pasarelas, etc.) no suministrados con la luminaria.
5. Piezas de plástico, como por ejemplo policarbonato o PMMA, sometidas a envejecimiento natural.
6. Daños del producto debidos a negligencia, al transporte y a eventos imprevistos e imprevisibles que no entren en las condiciones normales de uso según el punto 1.1 (por ej.: descargas eléctricas y rayos).
7. Productos que hayan estado en funcionamiento durante un número de horas al año superior a 6.500 h.
8. Luminarias no utilizadas con el propósito para el que se han realizado.
9. Kohl Lighting no será responsable en ningún caso de daños accidentales, de compensación, consecuentes, indirectos, especiales u otros daños. La responsabilidad de Kohl Lighting respecto a un defecto del producto debe quedar limitada en todo caso a la suma pagada por ese producto defectuoso.

Esta garantía convencional es la única garantía otorgada por Kohl Lighting y se concede con exclusión de las demás garantías, explícitas o implícitas como, por ejemplo, garantías de comerciabilidad o adecuación para un propósito particular. Las medidas adoptadas de forma exclusiva por parte del comprador para cualquier no conformidad o defecto en un producto serán sólo las previstas por esta garantía. Las prestaciones y la duración de los LEDs no están garantizadas si las luminarias se han instalado en tornos con presencia de sustancias químicas incompatibles con los mismos LEDs. Nuestro departamento técnico está a disposición para comprobar la compatibilidad de los LEDs que utilizamos en relación con las sustancias presentes en el entorno donde se instalan las luminarias.





*Kohl Lighting S.L. reserves the right to reproduce total or partially this catalogue as Copyright owner.*

*All data, sketches and pictures are up to date at the day of print, nevertheless, due to continuous product development and improvement, Kohl Lighting reserves the right to alter them without prior notice.*

*Last catalogue version in **kohl-lighting.com***

Kohl Lighting S.L. se reserva el derecho de reproducción total o parcial de este catálogo como propietario del Copyright.

Todos los datos, croquis, precios e imágenes están actualizados el día de la impresión, sin embargo, debido al continuo desarrollo y mejora de los productos, Kohl Lighting se reserva el derecho de modificarlos sin previo aviso.

Última versión de catálogo en **kohl-lighting.com**

Kohl Lighting  
Copyright © 2024

*Print date / Fecha de impresión  
September / Septiembre 2024*

*Design and layout / Diseño y maquetación  
Kohl-lighting Team / Equipo Kohl-Lighting*