



FULL LINE CATALOG



# POWERUP



POWERUP  
ON THE WEB



VENTURE **OUT**



TAKE **PRIDE**



CREATE **MEMORIES**



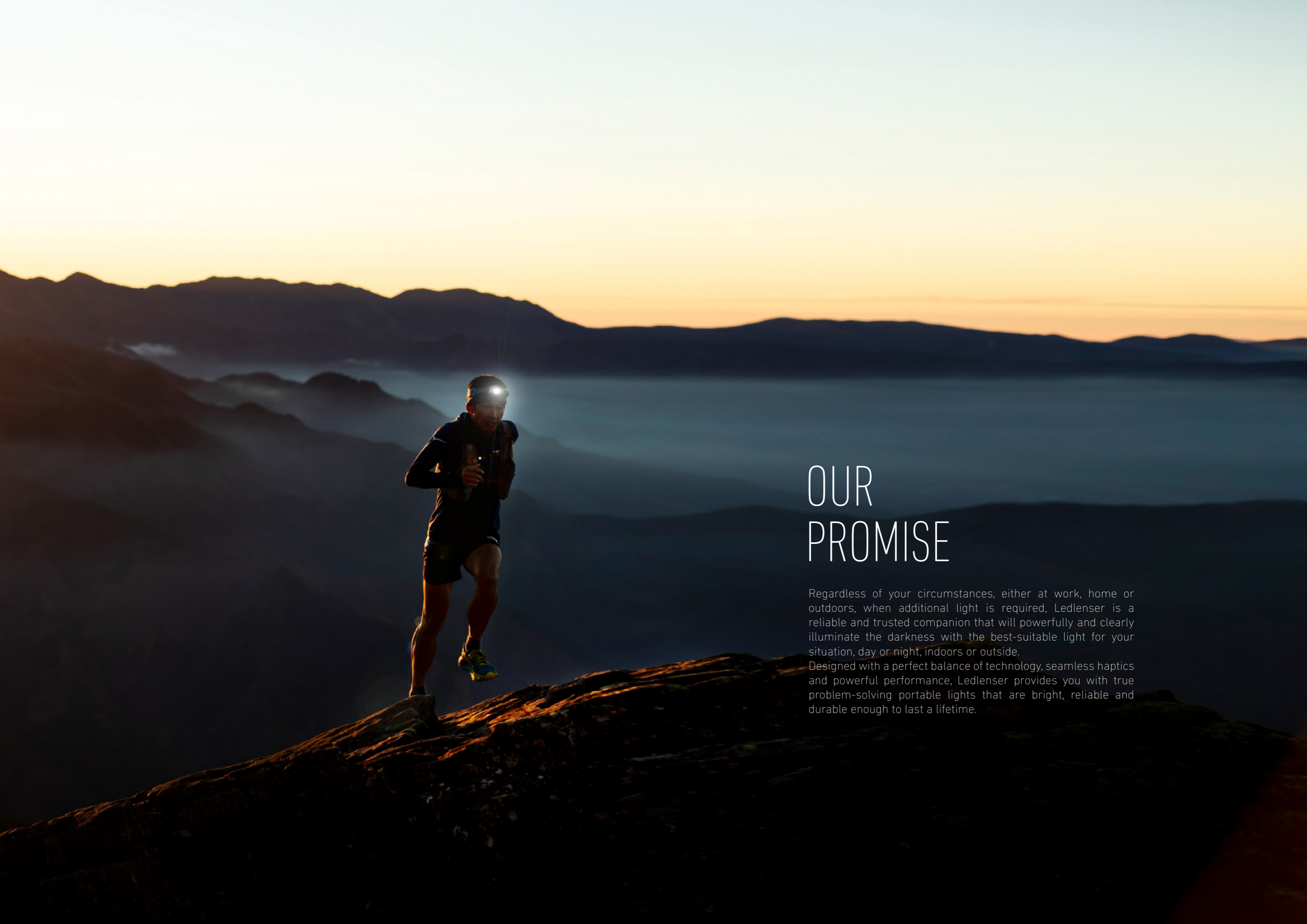

# OUR PROMISE

Regardless of your circumstances, either at work, home or outdoors, when additional light is required, Ledlenser is a reliable and trusted companion that will powerfully and clearly illuminate the darkness with the best-suitable light for your situation, day or night, indoors or outside. Designed with a perfect balance of technology, seamless haptics and powerful performance, Ledlenser provides you with true problem-solving portable lights that are bright, reliable and durable enough to last a lifetime.



# CONTENT

**CONTENT CLICKABLE** ↓

## POWERUP

# 1

6-23 **CORE-WORK-SIGNATURE**  
the revolutionary concept  
ledlenser Connecting System



### 58 WORK & PROFESSIONAL

- 58 **FLASHLIGHTS**
- 60 P2R Work
- 60 P4R Work
- 61 P5R Work
- 64 P6R Work
- 62 / 64 P7R Work
- 65 P18R Work
- 66 P7R Work UV
- 68 ACCESSORIES P-Series Work



- 72 **HEADLAMPS**
- 77 H5R Work
- 77 H7R Work
- 77 H15R Work
- 78 ACCESSORIES H-Series Work



- 80 iH3
- 80 iH5
- 81 iH5R
- 83 iH8R
- 83 iH9R
- 83 iH11R



- 84 ACCESSORIES HEADLAMPS

- 86 **WORKLIGHTS**
- 89 W1R Work **NEW**
- 89 W2 Work **NEW**
- 89 W2R Work **NEW**
- 92 W4R Work **NEW**
- 92 W5R Work **NEW**
- 93 W6R Work **NEW**
- 93 W7R Work **NEW**



- 94 **FLOODLIGHTS**
- 97 iF2R
- 97 iF3R
- 101 iF4R
- 98 / 101 iF4R music
- 99 / 101 iF8R



- 102 **INTRINSICALLY SAFE LIGHTS**
- 108 EX4
- 108 EX7
- 106 / 108 EX7R
- 109 EXH8
- 109 EXH8R
- 110 INTRINSICALLY SAFE LIGHTS ACCESSORIES



### 112 OUTDOOR & SPORTS

- 112 **FLASHLIGHTS**
- 116 P6R Signature
- 116 / 114 P7R Signature
- 117 P18R Signature
- 118 ACCESSORIES P-Series Signature



- 122 **HEADLAMPS**
- 127 H7R Signature
- 127 / 124 H19R Signature
- 128 ACCESSORIES H-Series Signature



- 132 MH3
- 132 MH4
- 133 MH5
- 134 MH7
- 134 MH8
- 135 MH10
- 135 / 130 MH11



- 138 / 137 NE01R
- 138 / 137 NE03
- 138 / 137 NE05R
- 138 / 137 NE09R



- 140 ACCESSORIES HEADLAMPS

- 142 **CLIPLIGHT**
- 143 CU2R



- 144 **LANTERNS**
- 148 ML4
- 148 ML4 Warm Light
- 149 ML6
- 149 ML6 Warm Light
- 149 / 146 ML6 Connect WL
- 150 ACCESSORIES LANTERNS



### 152 PORTABLE ENERGY

- 152 **PORTABLE ENERGY**
- 154 FLEX3
- 154 FLEX5
- 156 FLEX7
- 156 FLEX10

# 2

### 24 HOME & LIFE

#### 26 FLASHLIGHTS

- 26 P2R Core
- 26 P3 Core
- 27 P4 Core
- 27 P4R Core
- 28 P5 Core
- 28 P5R Core
- 29 P6 Core
- 29 P6R Core
- 33 P7 Core
- 30 / 33 P7R Core
- 33 P17R Core
- 34 P6R Core QC
- 36 ACCESSORIES P-Series Core

- 40 K4R
- 41 K6R
- 41 K6R SAFETY

- 42 X21R

#### 44 HEADLAMPS

- 48 H5 Core
- 48 H5R Core
- 46 / 49 H7R Core
- 49 H15R Core
- 49 H19R Core
- 50 ACCESSORIES H-Series Core

#### 52 KIDSLIGHTS

- 56 KIDLED2
- 56 KIDLED4R
- 57 KIDBEAM4
- 57 KIDCAMP6

**NEW**



### PRODUCT VIDEOS

Simply scan the QR code



# 6

- 158 **Technologies**
- 160 TECHNOLOGY ABC
- 164 LIGHT FUNCTIONS
- 165 IP PREDECTION CLASSES
- 166 RECOMMENDED APPLICATION

# 7

- 168 **ABOUT US**
- 170 THE COMPANY
- 172 MILESTONES
- 174 QUALITY
- 175 GUARANTEE
- 175 ISO CERTIFICATION

- 176 **SERVICE**
- 176 INFORMATION
- 177 CONTACT



**THIS BUTTON ALLOWS YOU TO QUICKLY JUMP FROM EVERY PAGE BACK TO THE TABLE OF CONTENTS**



CORE-WORK-SIGNATURE  
The revolutionary concept



 LEDLENSER



# CORE-WORK-SIGNATURE

## The revolutionary concept P-Series and H-Series

For many years, people in need of the perfect flashlight for a multitude of applications have trusted our legendary **P-Series**. If they needed to combine free hands with perfect illumination, they trusted our **H-Series**.

This latest version of our most important product lines is far more than a revision: it is a **revolution in lighting**. With trendsetting features and technologies, significantly more power and the **Core – Work – Signature** concept, we are transporting our portfolio into the future and opening it up to many new user groups.

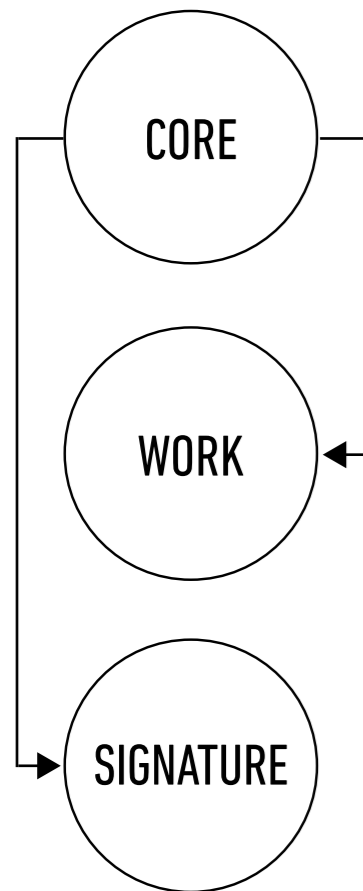

The lights in the **Core line** form the heart of the P-Series and H-Series. They follow the great legacy of the famous previous P- and H-Series and in doing so, combine a proven and tested history with new technology. Core lights are ideally suitable for a **wide range of applications for everyday or on-the-job use** and are distinguished by an excellent price-performance ratio.

The **Work line** lights are specifically developed for routine applications in challenging work environments. Built on a Core line foundation with additional work-enhancing features, – e.g. **increased protection against impact, drops and chemicals**, optimized light with natural color reproduction as well as a **wide range of helpful accessories included**.

Our **Signature models** represent the premium line of the P-Series and H-Series. These **high-end lights** combine **all functions** of the Core models with **increased power** and a **larger range of features** as well as a classy design, enhanced materials and a **wide range of accessories included**.



GERMAN ENGINEERING & DESIGN

<sup>1-8</sup> Information on page 176



### Lighting professionals at work

- ▶ extensive package of features and functions
- ▶ excellent light quality and workmanship
- ▶ strong protection against water and dust
- ▶ **robust & durable**
- ▶ **natural color reproduction**
- ▶ **specific accessories included**

#### FIELDS OF USE

Industry and craftsman, various professional groups



### Loyal lights for every day

- ▶ extensive package of features and functions
- ▶ excellent light quality and workmanship
- ▶ strong protection against water and dust
- ▶ **convincing price-performance ratio**

#### FIELDS OF USE

Recreation, job and everyday life



### The perfect light for the highest demands

- ▶ **extensive package of features and functions**
- ▶ excellent light quality and workmanship
- ▶ strong protection against water and dust
- ▶ **use of premium materials**
- ▶ **natural color reproduction**
- ▶ **specific accessories included**

#### FIELDS OF USE

Outdoor, sport, photography and lifestyle





# CORE-WORK-SIGNATURE

## Ledlenser Connecting System

Thanks to the **modular design** of this product series, it has never been easier to take advantage of our **extensive range of accessories**. Our **Ledlenser Connecting System** creates a **universal interface**, which ensures that the respective accessory can be combined with a multitude of flashlights and headlamps. This enables an even more versatile uses and an **expansion of the application options** of our lights.

## More functions and Technologies than ever before

Never before have so many features, functions and details been combined into a new product series. That includes a number of new developments, e.g. our patent pending **Flex Sealing Technology** for **maximum protection against dust and water** while maintaining focus ability or **constant, flicker-free light**, which maintains a high degree of brightness over time.



**FLEX SEALING TECHNOLOGY**

We also revised some of our existing Technologies such as the **Magnetic Charge System** for **easy, reliable and fast charging** and conceived new ones such as the **Smart Light Technology** for complete, **individual programmability of the light functions**.



**MAGNETIC CHARGE SYSTEM**

Technologies that have existed since the first P-Series and H-Series, such as our patented<sup>3</sup> **Advanced Focus System**, are still used and leave no doubt that the new series are genuine Ledlenser products.



**SMART LIGHT TECHNOLOGY**

And the most important thing: every user will find **the perfect light for their purpose** among the models of the P-Series and H-Series.



**ADVANCED FOCUS SYSTEM**

<sup>1-3</sup> Information on page 176

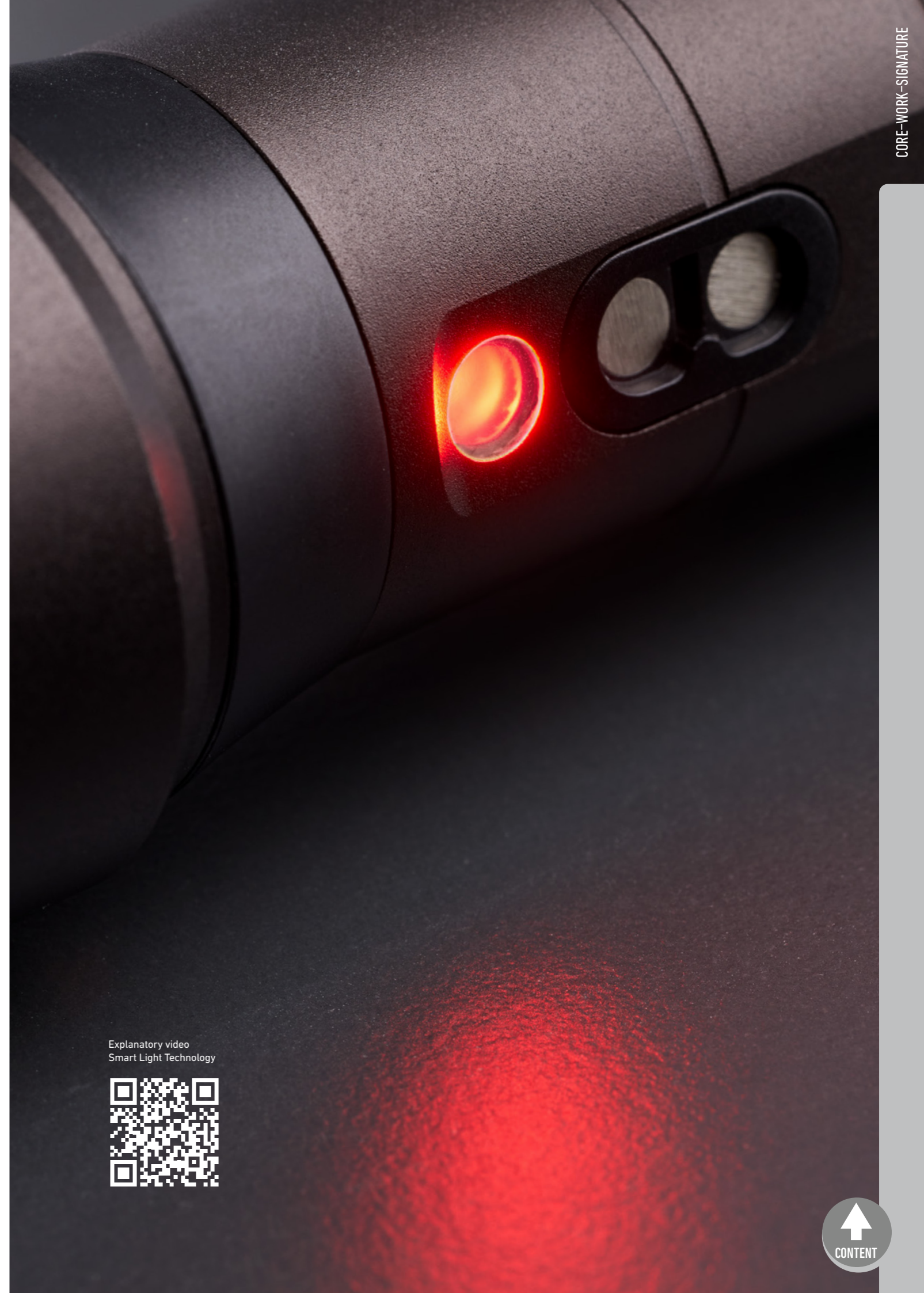

Explanatory video  
Smart Light Technology

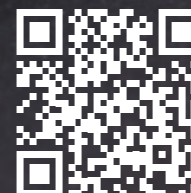



## THE P-SERIES

# THE P-SERIES FROM LEDLENSER IS ALWAYS A STATEMENT

The robust and reliable flashlights of the P-Series offer an impressive package of features in a stylish design.

Furthermore, the P-Series is the first modularly designed Ledlenser flashlight series. In the Core, Work and Signature versions, each of the lights are customized for different target groups from everyday users to professionals in trade and industry to outdoor enthusiasts.

## P7R CORE

### THE INDISPENSABLE MODEL

☀ 1400 lm<sup>1</sup>  
 ↗ 300 m<sup>1</sup>  
 ⌚ 90 h<sup>1</sup>



- 01 – **Multi-Core Optics** – homogeneous beam made possible by special faceting of the lens
- 02 – **Advanced Focus System** – stepless focusing
- 03 – Extreme **dust and water protection (IP68)**
- 04 – **Flex Sealing Technology** – can be used for a short time underwater (including the focusing system) to a depth of one meter
- 05 – Personalize the light functions thanks to **Smart Light Technology**
- 06 – **Constant Light** – consistent level of brightness over time
- 07 – **Flicker-free** – flicker-free, constant light enables optimal and safe illumination of fast-moving parts and machines
- 08 – Convenient and safe charging of the battery thanks to the **Magnetic Charge System**
- 09 – Integrated **battery and charge status display**

**Contents:** 1 battery pack, lanyard, magnetic charging cable

## P7R WORK

### THE ROBUST MODEL

☀ 1200 lm<sup>1</sup>  
 ↗ 240 m<sup>1</sup>  
 ⌚ 60 h<sup>1</sup>

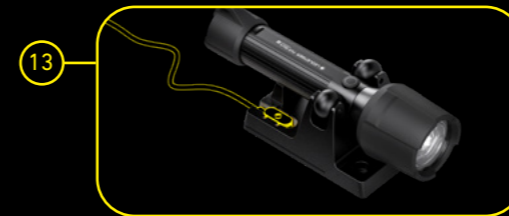

**The P7R Work has all characteristics of the P7R Core with additional features and accessories for professional use**

- 10 – **Predictive elements on the lamp head and the end cap** absorb impacts and increase slip resistance; **the additional front lens cover** protects the lens from scratching
- 11 – **Neutral white light** with natural **Color rendering (CRI 90)**
- 12 – **Secondary white light** on the side of the housing for diffuse illumination at close range
- 13 – **Robust charging station** - suitable for installation in a vehicle and compatible with the 5 station charging panel

**Contents:** 1 battery set, charging station, belt pouch, adjustable lanyard, intelligent clip, magnetic charging cable, USB power adapter

## P7R SIGNATURE

### THE PREMIUM MODEL

☀ 2000 lm<sup>1</sup>  
 ↗ 330 m<sup>1</sup>  
 ⌚ 90 h<sup>1</sup>



**The P7R Signature has all characteristics of the P7R Core with additional premium features and includes a more extensive range of accessories**

- 14 – **Mode Switch** for direct access to personalized Light functions thanks to Smart Light Technology
- 15 – **Secondary red light** on the side of the housing, e.g. to maintain night vision in the dark
- 16 – **Hard anodized housing** for additional protection against wear and corrosion
- 17 – **Natural color rendering (CRI 80)**
- 18 – Practical **pocket clip** - also serves as roll protection

**Contents:** 1 battery set, leather belt pouch, adjustable lanyard, magnetic charging cable, pocket clip, USB power adapter, wall mount



# ÜBERSICHT DER P-SERIES

THE ROBUST MODELS		THE INDISPENSABLE MODELS		THE PREMIUM MODELS	
WORK		CORE		SIGNATURE	
RECHARGEABLE-MODELS		RECHARGEABLE-MODELS		RECHARGEABLE-MODELS	
<b>P2R WORK</b> Item no. 502183	€39.90 (MSRP)	<b>P2R CORE</b> Item no. 502176	€25.90 (MSRP)		
Luminous flux: 110 lm <sup>1</sup>	CRI: 80	Luminous flux: 120 lm <sup>1</sup>	CRI: 70		
Color temp.: 4300 K	Drop height: 2 m	Color temp.: 6500 K	Drop height: 2 m		
<b>P4R WORK</b> Item no. 502184	€54.90 (MSRP)	<b>P4R CORE</b> Item no. 502177	€39.90 (MSRP)		
Luminous flux: 170 lm <sup>1</sup>	CRI: 80	Luminous flux: 200 lm <sup>1</sup>	CRI: 70		
Color temp.: 4300 K	Drop height: 2 m	Color temp.: 6500 K	Drop height: 2 m		
<b>P5R WORK</b> Item no. 502185	€84.90 (MSRP)	<b>P5R CORE</b> Item no. 502178	€74.90 (MSRP)		
Luminous flux: 480 lm <sup>1</sup>	CRI: 70	Luminous flux: 500 lm <sup>1</sup>	CRI: 70		
Color temp.: 4000 K	Drop height: 3 m	Color temp.: 6500 K	Drop height: 2 m		
<b>P6R WORK</b> Item no. 502186	€109.00 (MSRP)	<b>P6R CORE</b> Item no. 502179	€94.90 (MSRP)		
Luminous flux: 850 lm <sup>1</sup>	CRI: 90	Luminous flux: 900 lm <sup>1</sup>	CRI: 65		
Color temp.: 4000 K	Drop height: 3 m	Color temp.: 6500 K	Drop height: 2 m		
<b>P7R WORK</b> Item no. 502187	€145.00 (MSRP)	<b>P7R CORE</b> Item no. 502181	€115.00 (MSRP)		
Luminous flux: 1200 lm <sup>1</sup>	CRI: 90	Luminous flux: 1400 lm <sup>1</sup>	CRI: 70		
Color temp.: 4000 K	Drop height: 3 m	Color temp.: 6500 K	Drop height: 2 m		
<b>P18R WORK</b> Item no. 502188	€269.00 (MSRP)	<b>P17R CORE</b> Item no. 502182	€219.00 (MSRP)		
Luminous flux: 4500 lm <sup>1</sup>	CRI: 70	Luminous flux: 1200 lm <sup>1</sup>	CRI: 65		
Color temp.: 5000 K	Drop height: 1 m	Color temp.: 6500 K	Drop height: 1 m		
<b>P18R SIGNATURE</b> Item no. 502191	€269.00 (MSRP)				
Luminous flux: 4500 lm <sup>1</sup>	CRI: 70				
Color temp.: 6500 K	Drop height: 1 m				

THE INDISPENSABLE MODELS	
CORE	
BATTERY-MODELS	
<b>P3 CORE</b> Item no. 502597	€15.90 (MSRP)
Luminous flux: 90 lm <sup>1</sup>	CRI: 70
Color temp.: 6500 K	Drop height: 2 m
<b>P4 CORE</b> Item no. 502598	€26.90 (MSRP)
Luminous flux: 120 lm <sup>1</sup>	CRI: 70
Color temp.: 6500 K	Drop height: 2 m
<b>P5 CORE</b> Item no. 502599	€49.90 (MSRP)
Luminous flux: 150 lm <sup>1</sup>	CRI: 70
Color temp.: 6500 K	Drop height: 2 m
<b>P6 CORE</b> Item no. 502600	€54.90 (MSRP)
Luminous flux: 300 lm <sup>1</sup>	CRI: 70
Color temp.: 6500 K	Drop height: 2 m
<b>P7 CORE</b> Item no. 502180	€74.90 (MSRP)
Luminous flux: 450 lm <sup>1</sup>	CRI: 70
Color temp.: 6500 K	Drop height: 1 m



\* also available as **P6R Core QC (WITH MULTICOLOR LED)** > on page 34  
 also available as **P7R Work UV (WITH UV LIGHT)** > on page 66



THE P-SERIES

# LEDLENSER CONNECTING SYSTEM

As a newly created interface, the Ledlenser Connecting System makes it easy, to connect the flashlights of the P-Series and their accessories with a simple click. It allows our lights to transform into a variety of uses. Simply clip the lamp adapter to the shaft of the light, attach the suitable accessory, and you're ready to go.

And, above all: The Ledlenser Connecting System works across the P-Series and even the headlamps in the H-Series. One accessory can be used with different kinds of products for convenience and cost savings.

**Lamp Adapter**  
Mounting adapter - the Ledlenser connecting system  
**€4.90 (MSRP)**

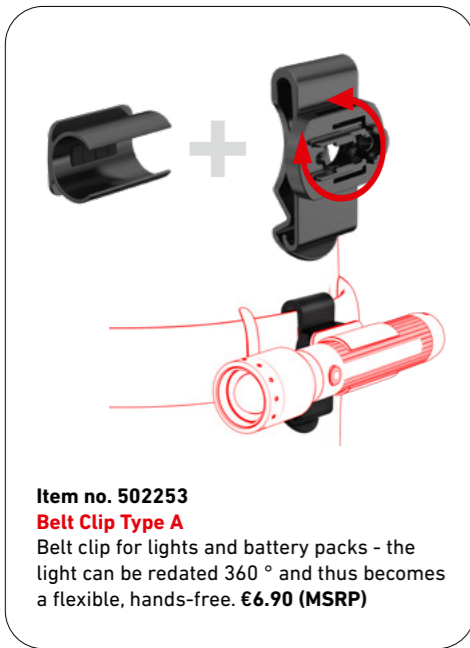

**Item no. 502253**  
**Belt Clip Type A**  
Belt clip for lights and battery packs - the light can be redated 360° and thus becomes a flexible, hands-free. **€6.90 (MSRP)**



Light Adapters are available in these sizes:

P2R Core/Work, P4R Core/Work:  
**Lamp Adapter Type A**  
Item no. 502248

P5R Core  
**Lamp Adapter Type B**  
Item no. 502249

P6R Core/Signature:  
**Lamp Adapter Type C**  
Item no. 502250

P7R Core/Signature:  
**Lamp Adapter Type D**  
Item no. 502251

Note: The P5R Work, P6R Work and P7R Work, already include a Lamp Adapter.

**Item no. 502247**  
**Tripod Adapter Type D**  
Tripod adapter with 1/4 inch thread for stable attachment  
**€9.90 (MSRP)**

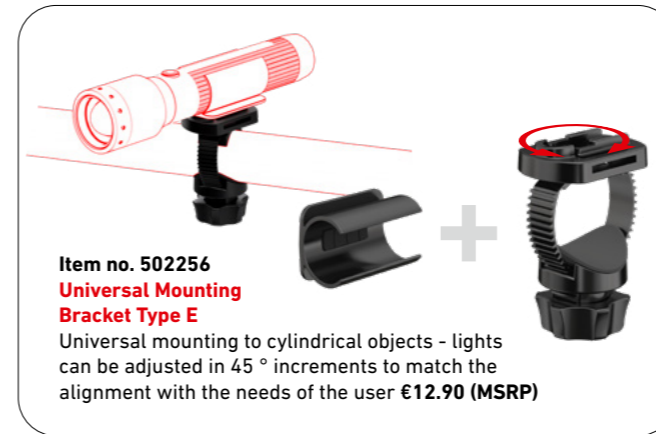
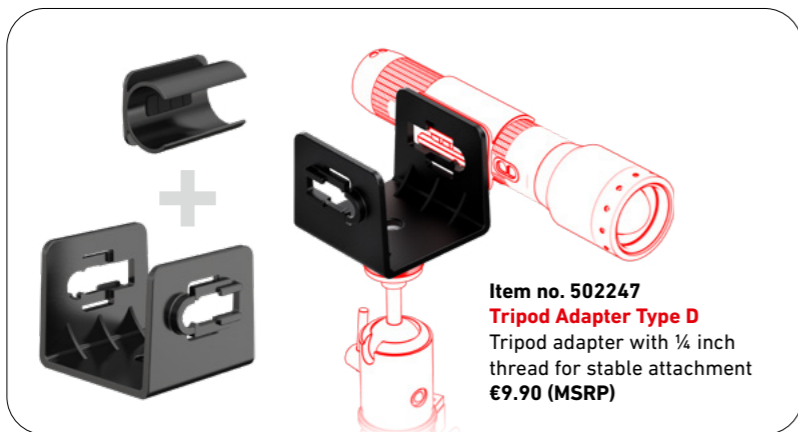

**Item no. 502256**  
**Universal Mounting Bracket Type E**  
Universal mounting to cylindrical objects - lights can be adjusted in 45° increments to match the alignment with the needs of the user **€12.90 (MSRP)**

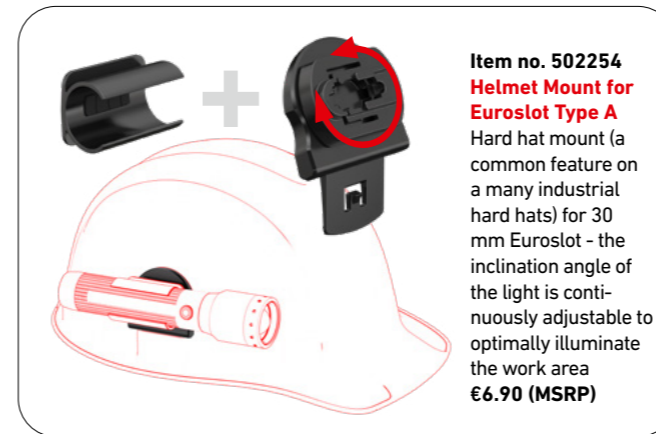

**Item no. 502254**  
**Helmet Mount for Euroslot Type A**  
Hard hat mount (a common feature on a many industrial hard hats) for 30 mm Euroslot - the inclination angle of the light is continuously adjustable to optimally illuminate the work area **€6.90 (MSRP)**



**Item no. 502246**  
**Adapter Type D (suitable for GoPro®)\***  
Compatible with almost all GoPro®-compatible systems and accessories - e.g. redary clip, suction cup or handlebar mount **€7.90 (MSRP)**



**Item no. 502255**  
**Flexible Mount Type A**  
Flexible fastening system with a magnetic base, adhesive pads and a hole for attachment with a screw. The light can be redated (360° horizontally and vertically). **€14.90 (MSRP)**

\* This product is not associated with GoPro® Inc. or its products and services. GoPro is a registered trademark of GoPro®, Inc.





## THE H-SERIES

# THE H-SERIES - A CROWNING ACHIEVEMENT

As trusted providers of light for countless fields of use, our H-Series headlamps are indispensable at home, at work or in the wilderness.

Intuitive operation, robust design, and fantastic illumination are the trademarks of this series – in addition to numerous features and Technologies. The best light for nearly every application when hands must remain free can be found in the Core, Work and Signature series whether for sports, recreational or occupational purposes.

## H7R CORE

### THE INDISPENSABLE MODEL

☀️ 1000 lm<sup>1</sup>  
 ↗️ 250 m<sup>1</sup>  
 ⌚ 65 h<sup>1</sup>



- 01 – **Advanced Focus System** – stepless focusing
- 02 – Extreme **dust and water predection (IP67)**
- 03 – **Flex Sealing Technology** – can be used for a short time underwater (including the focusing system) to a depth of one meter
- 04 – Intuitive operation and stepless dimming thanks to **Wheel switch** on the lamp head
- 05 – Stepless **swivel mechanism** for vertical alignment of the light cone
- 06 – **Constant Light** – consistent level of brightness over time
- 07 – **Flicker-free** – flicker-free, constant light enables optimal and safe illumination of fast-moving parts and machines
- 08 – Convenient and safe charging of the battery thanks to the **Magnetic Charge System**

**Contents:** 1 battery pack, magnetic charging cable

## H7R WORK

### THE ROBUST MODEL

☀️ 1000 lm<sup>1</sup>  
 ↗️ 250 m<sup>1</sup>  
 ⌚ 60 h<sup>1</sup>



**The H7R Work has all the features of the H7R Core with additional features and accessories for professional use**

- 09 – Extremely powerful, focusable headlamp for work: **high color rendering, neutral white light**
- 10 – **Innovatives Mounting System** enables easy removal and replacement of the lamp head and the battery for maximum flexibility (also available with H7R Core and H7R Signature)
- 11 – **Predective elements over the lens and battery** for high resistance to all types of impact
- 12 – **Microbe resistant material** - comfortable to wear and easy to clean

**Contents:** 1 battery set, magnetic charging cable, fastening clips for safe helmet mounting, focusing ring, transparent silicone tape, belt clip, extension cable

## H7R SIGNATURE

### THE PREMIUM MODEL

☀️ 1200 lm<sup>1</sup>  
 ↗️ 260 m<sup>1</sup>  
 ⌚ 65 h<sup>1</sup>

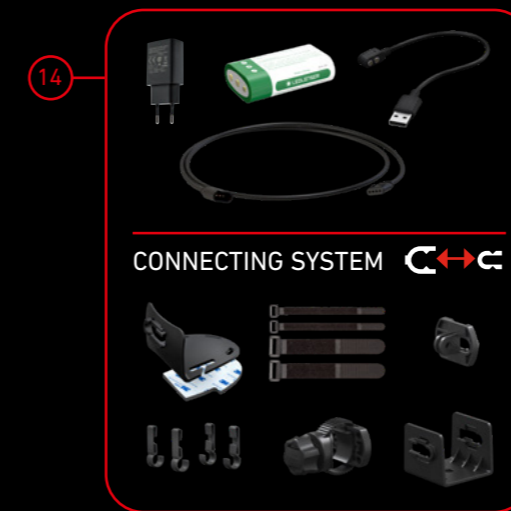

**The H7R Signature has all the features of the H7R Core with additional premium features and expanded content**

- 13 – **Ledlenser Connect App** enables personalization and remote control of the light functions
- 14 – **Wide range of accessories included**
- 15 – **Reflective headband** for optimal visibility

**Contents:** 1 battery set, fastening clips for safe helmet mounting, Adapter for GoPro products, helmet holder, velcro fasteners, magnetic charging cable, tripod holder, USB power adapter, universal holder, extension cable, soft case transport bag

<sup>1-8</sup> Information on page 176



# DIE H-SERIES

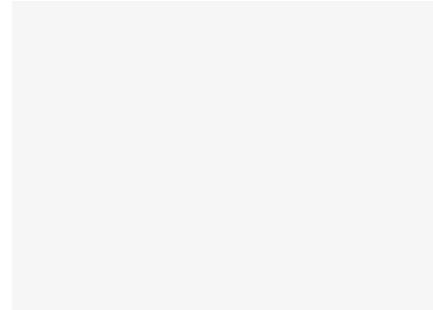

**H5 CORE** €54.90 (MSRP)  
Item no. 502193



Luminous flux CRI Color temp. Drop height  
350 lm<sup>1</sup> 70 6500 K 1.5 m

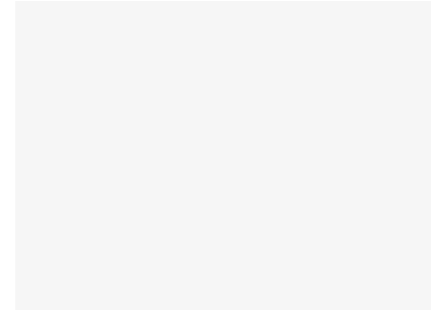

**H5R WORK** €94.90 (MSRP)  
Item no. 502194





Luminous flux CRI Color temp. Drop height  
500 lm<sup>1</sup> 80 4000 K 3 m

**H5R CORE** €84.90 (MSRP)  
Item no. 502121

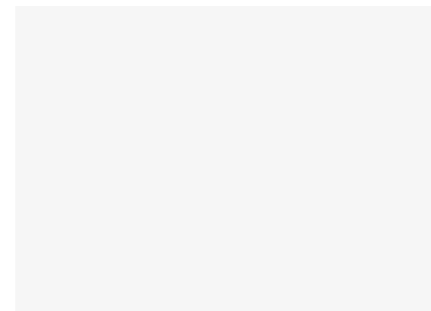

Luminous flux CRI Color temp. Drop height  
500 lm<sup>1</sup> 70 6500 K 1.5 m



**H7R WORK** €135.00 (MSRP)  
Item no. 502195



Luminous flux CRI Color temp. Drop height  
1000 lm<sup>1</sup> 90 4000 K 3 m

**H7R CORE** €99.90 (MSRP)  
Item no. 502122



Luminous flux CRI Color temp. Drop height  
1000 lm<sup>1</sup> 70 6500 K 1.5 m

**H7R SIGNATURE** €169.00 (MSRP)  
Item no. 502197





Luminous flux CRI Color temp. Drop height  
1200 lm<sup>1</sup> 80 6500 K 1.5 m

**H15R WORK** €199.00 (MSRP)  
Item no. 502196





Luminous flux CRI Color temp. Drop height  
2500 lm<sup>1</sup> 90 4000 K 3 m

**H15R CORE** €175.00 (MSRP)  
Item no. 502123

Luminous flux CRI Color temp. Drop height  
2500 lm<sup>1</sup> 70 6500 K 1.5 m

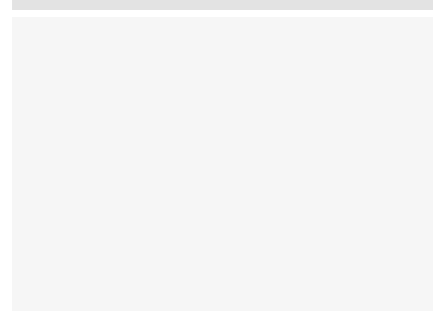
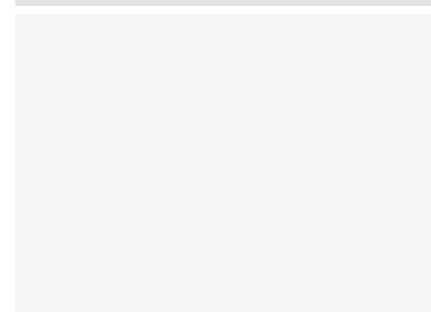

**H19R CORE** €225.00 (MSRP)  
Item no. 502124





Luminous flux CRI Color temp. Drop height  
3500 lm<sup>1</sup> 70 6500 K 1.5 m

**H19R SIGNATURE** €339.00 (MSRP)  
Item no. 502198



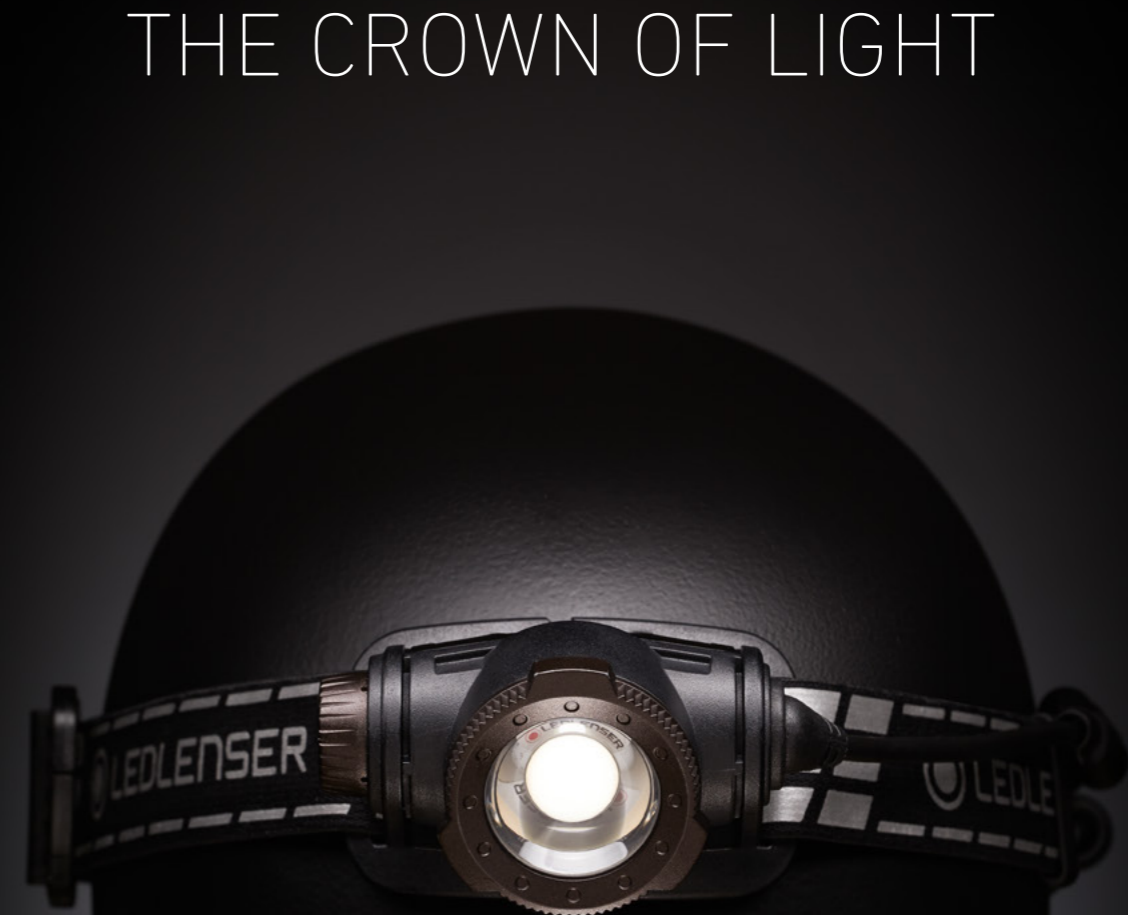

Luminous flux CRI Color temp. Drop height  
4000 lm<sup>1</sup> 80 6500 K 1.5 m



<sup>1</sup>\* Information on page 176



THE H-SERIES

# LEDLENSER CONNECTING SYSTEM

Like the P-Series, the headlamps of the H-Series can also be connected to an extensive selection of accessories thanks to the Ledlenser Connecting System.

The lamp head and rechargeable battery can each be quickly detached and easily connected to the suitable accessory via a coupling mechanism.



**Item no. 502314**  
**Helmet Connecting Kit H**

Stable and easy installation of the matching headlamp on a wide variety of helmets (e.g. bicycle helmets, workhard hats, etc.). If the helmet contains vents (like a bicycle helmet) the system can be quickly attached with Velcro fasteners. Alternatively, strong adhesive pads can be used. **€14.90 (MSRP)**



**Item no. 502256**  
**Universal Mounting**  
**Bracket Type E**

Universal mounting to cylindrical objects - lights can be adjusted in 45 ° increments to match the alignment with the needs of the user **€12.90 (MSRP)**



**Item no. 502253**  
**Belt Clip Type A**

Compatible with almost all GoPro-compatible systems and accessories - e.g. redary clip, suction cup or handlebar mount **€6.90 (MSRP)**



**Item no. 502246**  
**Adapter Type D (suitable for GoPro®)\***

Suitable for almost all GoPro compatible systems and accessories **€7.90 (MSRP)**



**Item no. 502247**  
**Tripod Adapter Type D**

Tripod adapter with 1/4 inch thread for stable attachment **€9.90 (MSRP)**

\* This product is not associated with GoPro Inc. or its products and services. GoPro is a registered trademark of GoPro, Inc.





# — HOME & LIFE FLASHLIGHTS



 LEDLENSER



# P-SERIES CORE



reddot winner 2021



**P2R CORE**



**P3 CORE**



**P4 CORE**



**P4R CORE**



LED		
LED-Configuration	1x Power LED	1x Power LED
Light Functions	Power / Mid Power / Low Power	Power / Mid Power / Low Power
Luminous Flux <sup>1</sup> (lm)	120 / 50 / 15	90 / 50 / 15
Beam Distance <sup>1</sup> (m)	65 / 45 / 15	110 / 70 / 40
Run Time <sup>1</sup> (h)	0.5 / 1 / 5	3 / 4 / 6
Color Temperature (K)	6000 - 7500	6000 - 7500
Color Rendering Index (CRI)	70	70
BATTERY AND CASE		
Battery	1x Li-ion Akku 3.7V mit Micro-USB	1x Micro (AAA) Alkaline 1.5V
Battery Capacity <sup>2</sup> (Wh / mAh)	0,74 / 200	
IP Level	IP54	IP54
Rechargeable	Yes	No
Charging Time <sup>5</sup> (min)	150	
Drop height (m)	2	2
SIZE AND WEIGHT		
Length – Defocused (mm)	103	96
Head Diameter (mm)	15	20
Weight incl. Battery (g / oz)	36 / 1.3	42 / 1.5
TECHNOLOGY		
Smart Light Technology		
Flex Sealing Technology		
Magnetic Charge System		
Temperature Control		
Advanced Focus System	●	●
More Features	Energy Saving	Rapid Focus
PACKAGING		
Item no. Box / GTIN	502176 / 4058205020367	502597 / 4058205028462
Contents Box	1 Battery Set, Pocket Clip, Micro-USB Charging Cable	1 Battery Set, Pocket Clip
Price (MSRP) in €	<b>25.90</b>	<b>15.90</b>
OPTIONAL ACCESSORIES		
	502248 Lamp Adapter Type A	0337 Pouch Type D
	0337 Pouch Type D	502248 Lamp Adapter Type A
	0380 USB Car Charger	
	502271 USB Adapter	

LED		
LED-Configuration	1x Power LED	1x Power LED
Light Functions	Power / Mid Power / Low Power	Power / Mid Power / Low Power
Luminous Flux <sup>1</sup> (lm)	120 / 60 / 15	200 / 90 / 15
Beam Distance <sup>1</sup> (m)	90 / 55 / 25	90 / 60 / 15
Run Time <sup>1</sup> (h)	5 / 9 / 20	1.5 / 3 / 25
Color Temperature (K)	6000 - 7500	6000 - 7500
Color Rendering Index (CRI)	70	70
BATTERY AND CASE		
Battery	2x Micro (AAA) Alkaline 1.5V	1x Li-ion Akku 3.7V mit Micro-USB
Battery Capacity <sup>2</sup> (Wh / mAh)		2.22 / 600
IP Level	IP54	IP54
Rechargeable	No	Yes
Charging Time <sup>5</sup> (min)		150
Drop height (m)	2	2
SIZE AND WEIGHT		
Length – Defocused (mm)	146	150
Head Diameter (mm)	15	15
Weight incl. Battery (g / oz)	58 / 2.0	55 / 1.9
TECHNOLOGY		
Smart Light Technology		
Flex Sealing Technology		
Magnetic Charge System		
Temperature Control		
Advanced Focus System	●	●
More Features		Energy Saving
PACKAGING		
Item no. Box / GTIN	502598 / 4058205028493	502177 / 4058205020398
Contents Box	1 Battery Set, Pocket Clip	1 Battery Set, Pocket Clip, Micro-USB Charging Cable
Price (MSRP) in €	<b>26.90</b>	<b>39.90</b>
OPTIONAL ACCESSORIES		
	502248 Lamp Adapter Type A	502248 Lamp Adapter Type A
		0380 USB Car Charger
		502271 USB Adapter

<sup>1-8</sup> Information on page 176





# P-SERIES CORE reddot winner 2021



**P5 CORE**



**P5R CORE**



LED		
LED-Configuration	1x High Power LED	1x High Power LED
Light Functions	Power / Mid Power / Low Power	Boost / Power / Mid Power / Low Power (+ Position, Blink, S.O.S., Strobe)
Luminous Flux <sup>1</sup> (lm)	150 / 60 / 15	500 / 350 / 130 / 15
Beam Distance <sup>1</sup> (m)	90 / 60 / 30	250 / 180 / 110 / 40
Run Time <sup>1</sup> (h)	2.5 / 5 / 12	- / 1 / 3.5 / 25
Color Temperature (K)	6000 - 7500	6000 - 7500
Color Rendering Index (CRI)	70	70
BATTERY AND CASE		
Battery	1x Mignon (AA) Alkaline 1.5V	1x 14500 Li-ion Battery 3.7V
Battery Capacity <sup>2</sup> (Wh / mAh)		2,77 / 750
IP Level	IP44	IP68
Rechargeable	No	Yes
Charging Time <sup>5</sup> (min)		120
Drop height (m)	2	2
SIZE AND WEIGHT		
Length – Defocused (mm)	120	123
Head Diameter (mm)	26	29
Weight incl. Battery (g / oz)	83 / 2.9	106 / 3.7
TECHNOLOGY		
Smart Light Technology		●
Flex Sealing Technology		●
Magnetic Charge System		●
Temperature Control		●
Advanced Focus System	●	●
More Features	Dual Power Source, Rapid Focus	Dimmable, Transportation Lock, Flicker-free, Memory Mode, Backup Mode, Emergency Light, Battery Indicator, Charge Indicator, Low Battery Warning
PACKAGING		
Item no. Box / GTIN	502599 / 4058205028523	502178 / 4058205020428
Contents Box	1 Battery Set, Lanyard	1 Battery Set, Lanyard, Magnetic Charging Cable
Price (MSRP) in €	<b>49.90</b>	<b>74.90</b>
OPTIONAL ACCESSORIES		
further accessories on page 84	502700 Lamp Adapter Type F	502248 Lamp Adapter Type B
	0337 Pouch Type D	502259 Charging Station Type A

 reddot winner 2021

 reddot winner 2021

 reddot winner 2021



**P6 CORE**



**P6R CORE**



LED		
LED-Configuration	1x High Power LED	1x Xtreme LED
Light Functions	Power / Low Power	Boost / Power / Mid Power / Low Power (+ Position, Blink, S.O.S., Strobe)
Luminous Flux <sup>1</sup> (lm)	300 / 25	900 / 600 / 240 / 15
Beam Distance <sup>1</sup> (m)	200 / 60	240 / 190 / 120 / 25
Run Time <sup>1</sup> (h)	3.5 / 25	- / 2 / 6 / 95
Color Temperature (K)	6000 - 7500	6000 - 7500
Color Rendering Index (CRI)	70	65
BATTERY AND CASE		
Battery	3x Micro (AAA) Alkaline 1.5V	1x18650 Li-ion Battery 3.7V
Battery Capacity <sup>2</sup> (Wh / mAh)		9.25 / 2500
IP Level	IP54	IP68
Rechargeable	No	Yes
Charging Time <sup>5</sup> (min)		300
Drop height (m)	2	2
SIZE AND WEIGHT		
Length – Defocused (mm)	117	151
Head Diameter (mm)	32	35
Weight incl. Battery (g / oz)	130 / 4.6	170 / 6.0
TECHNOLOGY		
Smart Light Technology		●
Flex Sealing Technology		●
Magnetic Charge System		●
Temperature Control		●
Advanced Focus System	●	●
More Features	Energy Saving, Rapid Focus	Dimmable, Transportation Lock, Flicker-free, Memory Mode, Backup Mode, Emergency Light, Temperature Control System, Battery Indicator, Charge Indicator, Low Battery Warning
PACKAGING		
Item no. Box / GTIN	502600 / 4058205028554	502179 / 4058205020459
Contents Box	1 Battery Set, Lanyard	1 Battery Set, Lanyard, Magnetic Charging Cable
Price (MSRP) in €	<b>54.90</b>	<b>94.90</b>
OPTIONAL ACCESSORIES		
further accessories on page 84		502250 Lamp Adapter Type C

<sup>1-8</sup> Information on page 176

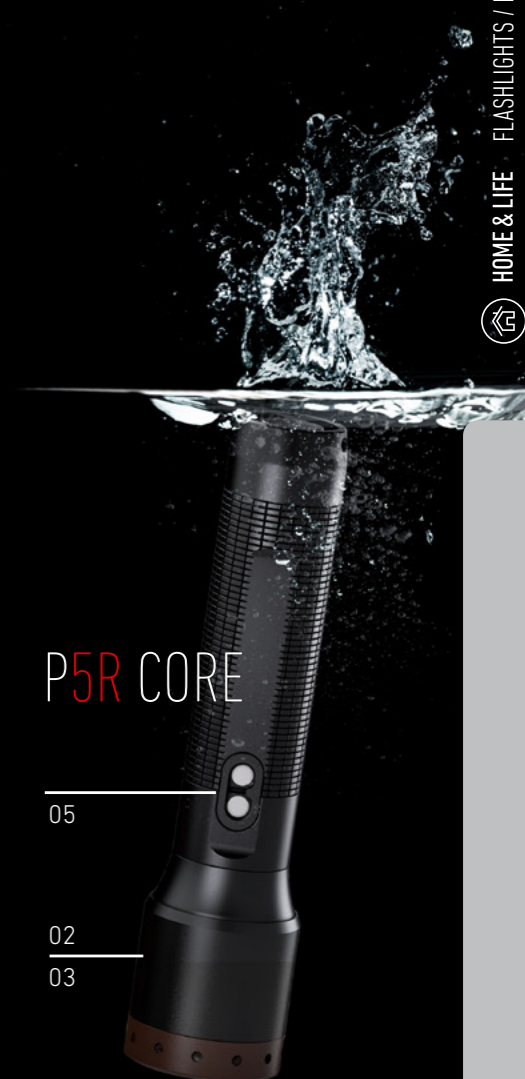

**P5R CORE**

05  
02  
03

- 01 – Extreme **dust and water predction (IP68)**
- 02 – **Advanced Focus System** – stepless focusing
- 03 – **Flex Sealing Technology** – can be used for a short time underwater (including the focusing system) to a depth of one meter
- 04 – Personalize the light functions thanks to **Smart Light Technology**
- 05 – Convenient and safe charging the battery thanks to the **Magnetic Charge System**
- 06 – **Constant Light** – constant luminous flux over a long period
- 07 – **Flicker-free** constant light enables optimal and safe illumination





CONTENT

# P7R CORE

THE P-SERIES  
A CLASSIC BECOMES  
A GENUINE BESTSELLER



 1400 lm<sup>1</sup>  
 300 m<sup>1</sup>  
 90 h<sup>1</sup>



- 01 – Extreme **Dust and Water Protection (IP68)**
- 02 – **Advanced Focus System** – stepless focusing
- 03 – **Flex Sealing Technology** – can be used for a short time underwater (including the focusing system) to a depth of one meter
- 04 – **Multi-Core Optics** – homogeneous beam made possible by special faceting of the lens
- 05 – Personalize the light functions thanks to **Smart Light Technology**
- 06 – Integrated **Battery and Charge Status Display**
- 07 – Convenient and safe charging of the battery thanks to the **Magnetic Charge System**



<sup>1-8</sup> Information on page 176





# P-SERIES CORE



## LED

	LED-Configuration
	Light Functions
	Luminous Flux <sup>1</sup> (lm)
	Beam Distance <sup>1</sup> (m)
	Run Time <sup>1</sup> (h)
	Color Temperature (K)
	Color Rendering Index (CRI)

## BATTERY AND CASE

	Battery
	Battery Capacity <sup>2</sup> (Wh / mAh)
	IP Level
	Rechargeable
	Charging Time <sup>5</sup> (min)
	Drop height (m)

## SIZE AND WEIGHT

	Length – Defocused (mm)
	Head Diameter (mm)
	Weight incl. Battery (g / oz)

## TECHNOLOGY

	Smart Light Technology
	Flex Sealing Technology
	Magnetic Charge System
	Multi Core Optics
	Advanced Focus System

More Features

## PACKAGING

Item no. Box / GTIN
Contents Box

Price (MSRP) in €

## OPTIONAL ACCESSORIES

further accessories on page 36



## P7 CORE

1x Power LED
Power / Mid Power / Low Power
450 / 250 / 40
300 / 220 / 100
1 / 2 / 25
6000 - 7500
70

4x Micro (AAA) Alkaline 1.5V
IP54
No
1

130
37
175 / 6.2

Energy Saving, Rapid Focus

502180 / 4058205020480
1 Battery Set, Lanyard

74.90



## P7R CORE

1x Xtreme LED
Boost / Power / Mid Power / Low Power (+ Position, Blink, S.O.S., Strobe)
1400 / 1000 / 440 / 15
300 / 210 / 130 / 15
- / 2 / 4 / 90
6000 - 7500
70

1x 21700 Li-ion Akku 3.7V
IP68
Yes
2

158
35
202 / 7.1

Dimmable, Transportation Lock, Flicker-free, Memory Mode, Backup Mode, Emergency Light, Temperature Control System, Battery Indicator, Charge Indicator, Low Battery Warning

502181 / 4058205020510
1 Battery Set, Lanyard, Magnetic Charging Cable

115.00



## P17R CORE

1x Xtreme LED
Boost / Power / Mid Power / Low Power (+ Position, Blink, S.O.S., Strobe)
1200 / 900 / 350 / 15
560 / 420 / 270 / 50
- / 2.75 / 12 / 200
6000 - 7500
65

1x LiFePO4 Akkupack 6,4V
IP54
Yes
1

290
53
715 / 25.2

Mode Switch, Dimmable, Transportation Lock, Flicker-free, Memory Mode, Backup Mode, Emergency Light, Safety Ytrion Cell, Rapid Focus, Battery Indicator, Charge Indicator, Low Battery Warning

502182 / 4058205020541
1 Set of Batteries, Intelligent Clip, Wall Mount, Power Adapter, Magnetic Charging Cable

219.00

502251 Lamp Adapter Type D

0042 Signal Cone 53mm

<sup>1-8</sup> Information on page 176



# P6R CORE QC



1 MULTICOLOR LED  
4 COLORS

- 01** – Equipped with a **Multicolor LED with white, red, green and blue light**
- 02** – **Multicolor Strobe** – colored flashes of light with irritating glare effect for emergencies
- 03** – **Easy Operation** – the redary switch enables quick color changes
- 04** – **Advanced Focus System** – stepless focusing



## P6R CORE QC



LED	
△ LED-Configuration	1x Power LED
▮ Light Functions (white light)	Power / Mid Power / Low Power
☀ Luminous Flux <sup>1</sup> (lm)	270 / 120 / 15
☞ Beam Distance <sup>1</sup> (m)	335 / 220 / 80
🕒 Run Time <sup>1</sup> (h)	5 / 14 / 110
🌡 Color Temperature (K)	6000 - 6500
📊 Color Rendering Index (CRI)	80 (white light)
AKKU UND GEHÄUSE	
🔋 Battery	1x Li-ion Akku 3,7V
🔋 Battery Capacity <sup>2</sup> (Wh / mAh)	9.25 / 2500
☁ IP Level	IP54
🔌 Rechargeable	Yes
🕒 Charging Time <sup>5</sup> (min)	300
↓ Drop height (m)	1.5
SIZE AND WEIGHT	
↗ Length – Defocused (mm)	157
⊙ Head Diameter (mm)	42
⚖ Weight incl. Battery (g / oz)	207 / 7.3
TECHNOLOGY	
🔄 Rapid Focus	●
🌀 Advanced Focus System	●
🔌 More Features	Multicolor Strobe, Singlecolor Strobe
PACKAGING	
Item no. Box / GTIN	502517 / 4058205026819
Contents Box	1 Battery Set, Lanyard, Micro-USB Charging Cable
<b>Price (MSRP) in €</b>	<b>94.90</b>
OPTIONAL ACCESSORIES	
	502251 Lamp Adapter Type D
further accessories on page 36	502729 Remote Switch Type G

<sup>1-8</sup> Information on page 176

# SEEING THE WORLD IN A DIFFERENT LIGHT

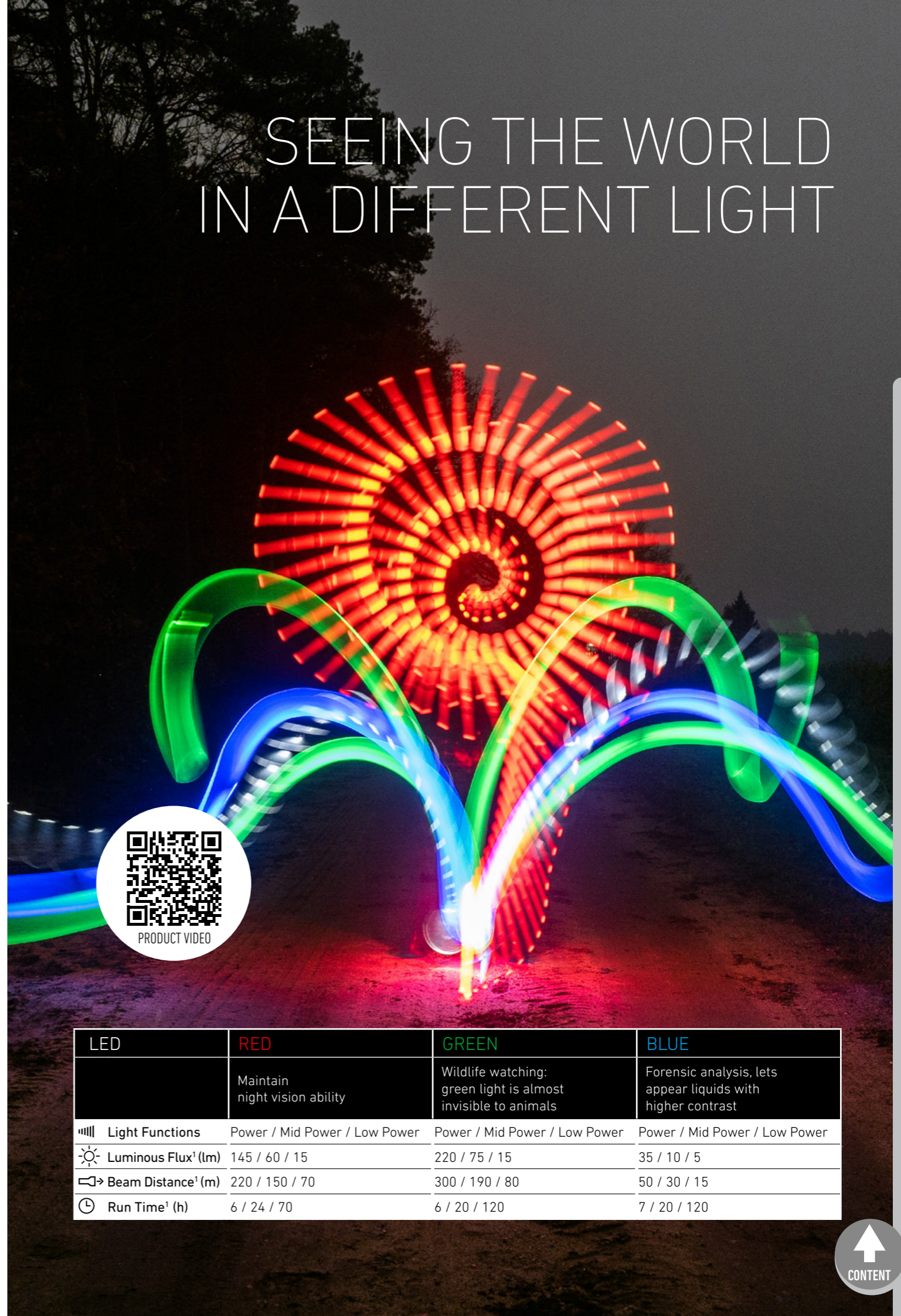

LED	RED	GREEN	BLUE
	Maintain night vision ability	Wildlife watching: green light is almost invisible to animals	Forensic analysis, lets appear liquids with higher contrast
▮ Light Functions	Power / Mid Power / Low Power	Power / Mid Power / Low Power	Power / Mid Power / Low Power
☀ Luminous Flux <sup>1</sup> (lm)	145 / 60 / 15	220 / 75 / 15	35 / 10 / 5
☞ Beam Distance <sup>1</sup> (m)	220 / 150 / 70	300 / 190 / 80	50 / 30 / 15
🕒 Run Time <sup>1</sup> (h)	6 / 24 / 70	6 / 20 / 120	7 / 20 / 120





# ACCESSORIES

## FLASHLIGHTS

### P-SERIES CORE

#### LEDLENSER CONNECTING SYSTEM

MODEL	P2R CORE	P4R CORE	P5 CORE	P5R CORE	P6R CORE	P7R CORE	P6R CORE QC	Item no.	MSRP (€)
Lamp Adapter Type A	•	•						502248	4.90
Lamp Adapter Type B				•				502249	4.90
Lamp Adapter Type C					•			502250	4.90
Lamp Adapter Type D						•	•	502251	4.90
Lamp Adapter Type F			•					502700	4.90
Adapter suitable for Tripod Type D	•	•	•	•	•	•	•	502247	9.90
Adapter suitable for GoPro® Type D	•	•	•	•	•	•	•	502246	7.90
Belt Clip Type A	•	•	•	•	•	•	•	502253	6.90
Helmet Mount for Euroslot Type A	•	•	•	•	•	•	•	502254	6.90
Flexible Mount Type A	•	•	•	•	•	•	•	502255	14.90
Universal Mounting Bracket Type E	•	•	•	•	•	•	•	502256	12.90

#### Lamp Adapter Type A-F

##### Mounting adapter (Requirement)

The adapter enables the connection between flashlights and the versatile LEDLENSER CONNECTING SYSTEM. Now the light is compatible with various additional accessory brackets and mounts.



Multiple sizes / item no's.  
€4.90 (MSRP)



Item no. 502246  
**Adapter suitable for GoPro**  
Compatible with almost all GoPro systems and accessories  
€7.90 (MSRP)



Item no. 502255  
**Flexible Mount**  
Flexible fastening system with magnet, adhesive pad and hole to screw on  
€14.90 (MSRP)



Item no. 502254  
**Helmet Mount for Euroslot**  
Hard hat mount for 30 mm Euroslot €6.90 (MSRP)



Item no. 502256  
**Universal Mounting Bracket**  
Stable universal fastening to cylindrical objects €12.90 (MSRP)



Item no. 502247  
**Tripod Adapter**  
Tripod adapter €9.90 (MSRP)



Item no. 502253  
**Belt Clip Type A**  
Belt clip for lights and battery packs €6.90 (MSRP)



Item no. 502511  
**Powerbank Flex5**  
More information on page 152  
€39.90 (MSRP)



Item no. 502127  
**Powerbank Flex10**  
More information on page 152  
€69.90 (MSRP)



Diverse Item no.  
**Charging Station**  
professional charging station  
Includes magnetic charging cable, compatible with 5 Station Charging Panel  
€12.90 (MSRP)



Diverse Item no.  
**Wall Mount**  
Wall mounting system incl. magnetic charging cable  
€9.90 (MSRP)



#### ACCESSORIES POWER SUPPLY

MODEL	P2R CORE	P4R CORE	P5 CORE	P5R CORE	P6 CORE	P6R CORE	P7 CORE	P7R CORE	P17R CORE	P6R CORE QC	Item no.	MSRP (€)
Remote Switch G										•	502729	18.90
Powerbank Flex3						•				•	502126	34.90
Powerbank Flex5								•			502511	39.90
Powerbank Flex7						•				•	502125	54.90
Powerbank Flex10								•			502127	69.90
Magnetic Charging Cable Type A	•	•		•		•		•			502265	6.90
Wall Mount Type A (magnetic charge cable included)						•					502257	9.90
Wall Mount Type B (magnetic charge cable included)								•			502258	9.90
Charging Station Type A (magnetic charge cable included)				•							502259	12.90
Charging Station Type B (magnetic charge cable included)						•		•			502260	12.90
5 Station Charging Panel				•		•		•			502261	69.90
USB Adapter 2.4A	•	•		•		•		•	•	•	502271	14.90
USB Car Charger	•	•		•		•		•		•	0380	9.90
Car Charger									•		0386	19.90
21700 Li-ion rech. bat. 4800mAh								•			502262	24.90
14500 Li-ion rech. bat. 750 mAh				•	•						500985	12.90
18650 Li-ion rech. bat. 3000 mAh						•				•	501001	24.90
Li-ion direct USB rech. bat. 2500 mAh						•				•	502595	24.90
Li-ion direct USB rech. bat. 880 mAh				•							502596	17.90

\* This product is not affiliated with GoPro Inc. or its products and services. services. GoPro is a registered trademark of GoPro, Inc.



# ACCESSORIES

## FLASHLIGHTS

### P-SERIES CORE

#### POUCHES / FILTERS / MOUNTS AND MORE

MODEL	P2R CORE	P5 CORE	P5R CORE	P6 CORE	P6R CORE	P7 CORE	P7R CORE	P17R CORE	P6R CORE QC	Item no.	MSRP (€)
Color Filter Set 35.1mm					•		•			502238	19.90
Color Filter Set 29.5mm			•							502239	18.90
Color Filter Set 53mm								•		502240	24.90
Signal Cone 35.1mm					•		•			502237	9.90
Signal Cone White 35.1mm					•		•			502243	9.90
Signal Cone White 53mm								•		502245	9.90
Signal Cone 37mm						•				0040	6.90
Signal Cone White 37mm						•				0040-W	6.90
Signal Cone 53mm								•		0042	9.90
Roll Predection 53mm								•		502241	14.90
Case Type A	•	•	•	•	•	•	•		•	502263	24.90
Case Type B	•	•	•	•	•	•	•		•	502264	29.90
Leather Pouch Type D					•		•			502269	19.90
Pouch Type D	•	•								0337	9.90
Pouch Type G					•		•		•	0342	9.90
Pouch Type A						•				0333	9.90
Intelligent Clip Type C						•				0317	8.90
Universal Mounting System				•	•	•	•		•	0362	14.90
Remote Switch Type G									•	502729	18.90



Diverse Item no.  
**Signal Cone Red**  
Der Steckaufsatz aus Kunststoff verwandelt die Ledlenser-Taschenlampe jederzeit schnell in ein vielseitiges, rotes Signallicht, z.B. für Einsätze im Straßen-, Bahn- und Flugverkehr, bei Notfällen oder in der Fotografie.

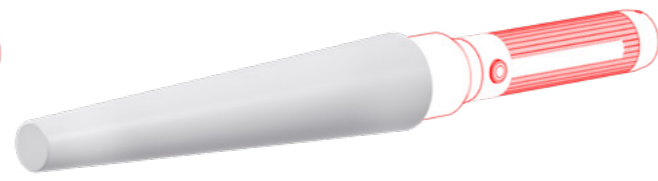

Diverse Item no.  
**Signal Cone White**  
Der Steckaufsatz aus Kunststoff verwandelt die Ledlenser-Taschenlampe jederzeit schnell in ein vielseitiges, whitees Signallicht. Ebenso kann die Taschenlampe mit dem whiteen Aufsatz in ein Rundumlicht verwandelt werden, um beispielsweise Räume oder ein Zelt gleichmäßig auszuleuchten.



Item no. 502263  
**Case Type A**  
**Soft case transport bag:** Inside there are elastic loops and a mesh pocket to attach the light, Powerbank, cables and other accessories. On the outside, a handle and loops for attachment to a belt or backpack ensure optimal portability. (Size 200mm x 135mm x 72mm)  
**€24.90 (MSRP)**



Diverse Item no.  
**Color Filter Sets**  
Color filter set: The filters are each pre-assembled on a color filter cap that can be attached directly to the lamp head of the compatible flashlight.  
**€12.90 (MSRP)**



Item no. 502264  
**Case Type B**  
With this high-quality, **fabric-covered hard case**, the Ledlenser light and accessories are always safely stored and protected from dust and external influences. Inside there are elastic loops and a mesh pocket to stow the light, Powerbank and other accessories. (Size 200mm x 135mm x 72mm)  
**€29.90 (MSRP)**



Item no. 502269  
**Leather Pouch**  
High quality belt bag made of real leather with magnetic closure  
**€19.90 (MSRP)**



Item no. 0342  
**Pouch**  
Fanny pack made of robust Polyamide fabric with elastic sidewalls  
**€9.90 (MSRP)**



Item no. 0362  
**Universal Mounting System**  
This universal mounting system quickly attaches flashlights with a diameter of 25-34 mm securely to tripods, rods and tubes.  
**€14.90 (MSRP)**



Item no. 0317  
**Intelligent Clip**  
Belt clip: the holder can be redated 360° and transforms the light into a flexible headlight  
**€8.90 (MSRP)**



# K-SERIE



**K4R**

LED	
LED-Configuration	1x Power LED
Light Functions	Boost / Power / Low Power
Luminous Flux <sup>1</sup> (lm)	120 / 80 / 20
Beam Distance <sup>1</sup> (m)	30 / 25 / 10
Run Time <sup>1</sup> (h)	- / 1 / 3.5
BATTERY AND CASE	
Battery	1x Li-ion Akku 3.7V
Battery Capacity <sup>2</sup> (Wh / mAh)	0.67 / 180
Rechargeable	Yes
Charging Time <sup>5</sup> (min)	180
IP Level	IP2X
SIZE AND WEIGHT	
Length – Defocused (mm)	52
Head Diameter (mm)	25
Weight incl. Battery (g / oz)	20 / 0.7
FEATURES	
Standard-MODEL	Transportation Lock, Battery Indicator, Charge Indicator
PACKAGING	
Item no. Box / Gray	<b>Gray:</b> 502574 / 4058205029117
Item no. Box / Rose Gold	<b>Rose Gold:</b> 502575 / 4058205029148
Contents Box	Carabiner
Price (MSRP) in €	<b>17.90</b>



**+ RED LIGHT**

**K6R**

LED	
LED-Configuration	1x High Power LED
Light Functions	Boost / Power / Low Power (+ red light)
Luminous Flux <sup>1</sup> (lm)	400 / 200 / 20
Beam Distance <sup>1</sup> (m)	80 / 50 / 15
Run Time <sup>1</sup> (h)	- / 1.5 / 10
BATTERY AND CASE	
Battery	1x Li-ion Akku 3.7V
Battery Capacity <sup>2</sup> (Wh / mAh)	2 / 550
Rechargeable	Yes
Charging Time <sup>5</sup> (min)	180
IP Level	IP2X
SIZE AND WEIGHT	
Length – Defocused (mm)	62
Head Diameter (mm)	30
Weight incl. Battery (g / oz)	30 / 1.1
FEATURES	
Standard-MODEL	Transportation Lock, Red Light, Battery Indicator, Charge Indicator
PACKAGING	
Item no. Box / Gray	<b>Gray:</b> 502577 / 4058205028318
Item no. Box / Rose Gold	<b>Rose Gold:</b> 502578 / 4058205028622
Contents Box	Carabiner
Price (MSRP) in €	<b>26.90</b>



**K6R Safety (Rose Gold)**

**K6R Safety**

LED	
LED-Configuration	1x High Power LED
Light Functions	Boost / Power / Low Power (+ Strobe)
Luminous Flux <sup>1</sup> (lm)	400 / 200 / 20
Beam Distance <sup>1</sup> (m)	80 / 50 / 15
Run Time <sup>1</sup> (h)	- / 1.5 / 8
BATTERY AND CASE	
Battery	1x Li-ion Akku 3.7V
Battery Capacity <sup>2</sup> (Wh / mAh)	1.48 / 400
Rechargeable	Yes
Charging Time <sup>5</sup> (min)	180
IP Level	IP2X
SIZE AND WEIGHT	
Length – Defocused (mm)	66
Head Diameter (mm)	30
Weight incl. Battery (g / oz)	32 / 1.1
FEATURES	
Standard-MODEL	Transportation Lock, Shriill Alarm, Battery Indicator, Charge Indicator
PACKAGING	
Item no. Box / Gray	<b>Safety Gray:</b> 502580 / 4058205028370
Item no. Box / Rose Gold	<b>Rose Gold:</b> 502581 / 4058205028721
Contents Box	Carabiner, Key Ring, Lanyard
Price (MSRP) in €	<b>26.90</b>

<sup>1-8</sup> Information on page 176



# X21R



☀️ 5000 lm<sup>1</sup>  
 ➡️ 800 m<sup>1</sup>  
 ⌚ 40 h<sup>1</sup>

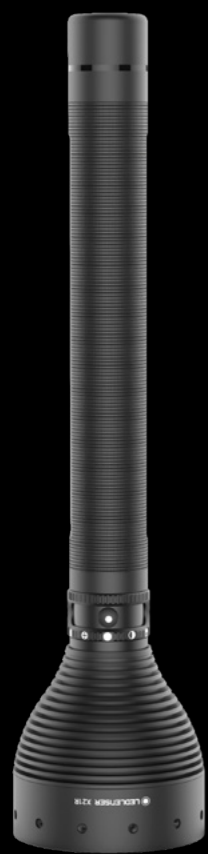

- 01 – Extreme light output** – up to 800 meters<sup>1</sup> beam distance with up to 5000 lumens<sup>1</sup> thanks to seven Xtreme LEDs
- 02 – X-Lens Technology** – precise synchronization of the bundles of rays from several reflector lenses to form an extremely homogeneous, stage-like floodlight or a very sharply focused high beam
- 03 – Advanced Focus System** – stepless focusing
- 04 – High-quality battery system Safety Ytrion Cell** - over 5000 charging cycles without significant loss of capacity
- 05 – Quick to hand** - convenient charging with the **Floating Charge System**
- 06 – Great ease of use** – 7 light functions, 4 light programs, 2 energy modes, and 1 multi-function switch



<sup>1-8</sup> Information on page 176

## EXTREME POWER RECHARGEABLE & MULTIFUNCTIONAL

### X21R

LED	
△ LED-Configuration	7x Xtreme LED
🔊 Light Functions	Boost / Power / Low Power (+ Blink, S.O.S., Strobe, Position)
☀️ Luminous Flux <sup>1</sup> (lm)	5000 / 3500 / 200
➡️ Beam Distance <sup>1</sup> (m)	800 / 700 / 150
⌚ Run Time <sup>1</sup> (h)	- / 5 / 40
BATTERY AND CASE	
🔋 Battery	1x LiFePO4 Akkupack 9,6V
🔋 Battery Capacity <sup>2</sup> (Wh / mAh)	48 / 5000
🔌 Rechargeable	Yes
⌚ Charging Time <sup>5</sup> (min)	210
☁️ IP Level	IP54
SIZE AND WEIGHT	
↗️ Length – Defocused (mm)	405
📏 Head Diameter (mm)	95
📏 Weight incl. Battery (g / oz)	1315 / 45.9
TECHNOLOGY	
🔌 Smart Light Technology	●
🔌 Rapid Focus	●
🔌 Floating Charge System	●
🔌 Advanced Focus System	●
🔌 X-Lens Technology	●
🔌 Emergency Light	●
🔌 Safety Ytrion Cell	●
🔌 Temperature Control	●
More Features	Energy Saving, Constant Light, Charge Indicator, Battery Indicator, Dimmable, Transportation Lock
PACKAGING	
Item no. Case / GTIN	501967 / 4058205015394
Contents	1 Battery Set, Floating Charge System, Assembly Material, Power Supply Unit, Roll Protection, Tripod Holder, Carrying Strap, Case
Price (MSRP) in €	<b>429.00</b>
OPTIONAL ACCESSORIES	
	0386 Car Charger

<sup>1-8</sup> Information on page 176





# HOME & LIFE HEADLAMPS





# H7R CORE

## THE H-SERIES ELEGANT HANDS-FREE ILLUMINATION



 1000 lm<sup>1</sup>  
 250 m<sup>1</sup>  
 65 h<sup>1</sup>

- 01 – Intuitive operation and stepless dimming thanks to the **Wheel switch** on the lamp head
- 02 – Strong **dust and water protection (IP67)**
- 03 – Stepless **swivel mechanism** for vertical alignment of the light cone
- 04 – **Advanced Focus System** – stepless focusing
- 05 – Convenient and safe charging of the battery thanks to the **Magnetic Charge System**
- 06 – Integrated **battery and charge status display**
- 07 – **Ledlenser Connecting System** – an interface for many accessories (see page 22)



<sup>1-8</sup> Information on page 176

# H-SERIES CORE



## H5 CORE

## H5R CORE

LED		
LED-Configuration	1x High Power LED	1x High Power LED
Light Functions	Boost / Power / Low Power	Boost / Power / Low Power
Luminous Flux <sup>1</sup> (lm)	350 / 200 / 15	500 / 300 / 15
Beam Distance <sup>1</sup> (m)	160 / 120 / 30	200 / 150 / 30
Run Time <sup>1</sup> (h)	- / 2 / 20	- / 2 / 50
Color Temperature (K)	6000 - 7500	6000 - 7500
Color Rendering Index (CRI)	70	70

BATTERY AND CASE		
Battery	2x Mignon (AA) Alkaline 1.5V	1x Li-ion Akkupack 3.7V
Battery Capacity <sup>2</sup> (Wh / mAh)	-	6.66 / 1800
IP Level	IP67	IP67
Rechargeable	No	Yes
Charging Time <sup>5</sup> (min)	-	210
Drop height (m)	1.5	1.5

SIZE AND WEIGHT		
Head Diameter (mm)	32	32
Weight incl. Battery (g / oz)	178 / 6.3	167 / 5.9

TECHNOLOGY		
Multi-Core Optics		
Flex Sealing Technology	●	●
Magnetic Charge System		●
Fusion Beam		
Advanced Focus System	●	●

More Features	Cooling Technology, Dimmable, Transportation Lock, Energy Saving	Cooling Technology, Temperature Control, Dimmable, Transportation Lock, Flicker-free, Memory Mode, Backup Mode, Battery Indicator, Charge Indicator, Low Battery Warning, Constant Light
---------------	--	--

PACKAGING		
Item no. Box / GTIN	502193 / 4058205020848	502121 / 4058205020879
Contents Box	1 Set of Batteries	1 Set of Batteries, Magnetic Charging Cable

Price (MSRP) in €	<b>54.90</b>	<b>84.90</b>
OPTIONAL ACCESSORIES		

further accessories on page 50      502451 Transp. Silicone Headband      502256 Universal Mounting Bracket



## H7R CORE



## H15R CORE



## H19R CORE

LED			
LED-Configuration	1x Xtreme LED	1x Xtreme LED	2x Xtreme LED
Light Functions	Boost / Power / Low Power	Boost / Power / Low Power	Boost / Power / Mid Power / Low Power
Luminous Flux <sup>1</sup> (lm)	1000 / 600 / 15	2500 / 1000 / 20	3500 / 1600 / 800 / 200
Beam Distance <sup>1</sup> (m)	250 / 200 / 25	250 / 170 / 20	300 / 230 / 150 / 80
Run Time <sup>1</sup> (h)	- / 4 / 65	- / 5 / 80	- / 4 / 7 / 20
Color Temperature (K)	6000 - 7500	6000 - 7500	6000 - 7500
Color Rendering Index (CRI)	70	70	70

Battery	1x 21700 Li-ion Akku 3.7V	1x Li-ion Akkupack 7.4V	1x Li-ion Akkupack 7.4V
Battery Capacity <sup>2</sup> (Wh / mAh)	17.76 / 4800	35.52 / 4800	35.52 / 4800
IP Level	IP67	IP67	IP68
Rechargeable	Yes	Yes	Yes
Charging Time <sup>5</sup> (min)	210	330	330
Drop height (m)	1.5	1.5	1.5

Head Diameter (mm)	41	47	68
Weight incl. Battery (g / oz)	259 / 9.1	380 / 13.4	374 / 13.2

Multi-Core Optics		●	●
Flex Sealing Technology	●	●	
Magnetic Charge System	●	●	●
Fusion Beam			●
Advanced Focus System	●	●	

More Features	Cooling Technology, Temperature Control, Dimmable, Transportation Lock, Flicker-free, Memory Mode, Backup Mode, Battery Indicator, Charge Indicator, Low Battery Warning, Constant Light	Cooling Technology, Temperature Control, Dimmable, Transportation Lock, Flicker-free, Memory Mode, Backup Mode, Battery Indicator, Charge Indicator, Low Battery Warning, Constant Light	Temperature Control, Cooling Technology, Optisense Technology, Dimmable, Transportation Lock, Flicker-free, Memory Mode, Backup Mode, Battery Indicator, Charge Indicator, Low Battery Warning, Constant Light, Red Light
---------------	--	--	---

Item no. Box / GTIN	502122 / 4058205020909	502123 / 4058205020930	502124 / 4058205020961
Contents Box	1 Set of Batteries, Magnetic Charging Cable	1 Set of Batteries, Magnetic Charging Cable	1 Set of Batteries, Magnetic Charging Cable

Price (MSRP) in €	<b>99.90</b>	<b>175.00</b>	<b>225.00</b>
OPTIONAL ACCESSORIES			

502262 21700 Li-Ion Recharge. Battery      502253 Belt Clip Type A      502246 Adapter suitable for GoPro® Type D

<sup>1-8</sup> Information on page 176





# ACCESSORIES

## HEADLAMPS

### H-SERIES CORE

#### LEDLENSER CONNECTING SYSTEM

MODEL	H5 CORE	H5R CORE	H7R CORE	H15R CORE	H19R CORE	Item no.	MSRP (€)
Adapter suitable for GoPro** Type D	•	•	•	•	•	502246	7.90
Adapter suitable for Tripod Type D	•	•	•	•	•	502247	9.90
Belt Clip Type A	•	•	•	•	•	502253	6.90
Helmet Connecting Kit Type H	•	•	•	•	•	502314	14.90
Universal Mounting Bracket Type E	•	•	•	•	•	502256	12.90



Thanks to the integrated slide the light is immediately compatible with various additional brackets

Item no. 502246  
**Adapter suitable for GoPro**  
Compatible with almost all GoPro systems and accessories  
**€7.90 (MSRP)**

Item no. 502253  
**Belt Clip Type A**  
Practical belt clip for lights and batteries  
**€6.90 (MSRP)**

Item no. 502314  
**Helmet Connecting Kit Type H**  
Stable helmet holder system for a wide variety of helmet models  
**€14.90 (MSRP)**

Item no. 502256  
**Universal Mounting Bracket**  
Stable universal fastening for rods  
**€12.90 (MSRP)**

Item no. 502247  
**Adapter suitable for Tripod**  
**€9.90 (MSRP)**



Multiple sizes / item no's.  
**Color Filter Set**  
Four high quality color filters: Red maintains night vision. Green and red are among others suitable for wildlife viewing. Yellow improves visibility in fog. Blue improves the visibility of liquids  
**€18.90 - €19.90 (MSRP)**



Item no. 502469  
**Headband with Overheadband CORE**  
Washable replacement headband with a removable overhead strap for additional support  
**€9.90 (MSRP)**



Item no. 502313  
**Helmet Band Fixing Clips**  
Practical helmet attachment set - fixes every headlamp safely and precisely on the helmet  
**€4.90 (MSRP)**



Item no. 502312  
**Extension Cable**  
Practical extension cable (120 cm) that is plugged in between the lamp head and the battery box - the battery can easily be stored in a backpack or carried on a belt clip  
**€9.90 (MSRP)**

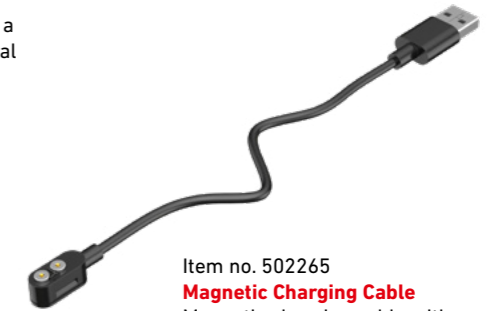

Item no. 502265  
**Magnetic Charging Cable**  
Magnetic charging cable with Standard USB-A connector  
**€6.90 (MSRP)**

#### COLOR FILTERS / CABLES / BATTERIES AND MORE

MODEL	H5 CORE	H5R CORE	H7R CORE	H15R CORE	H19R CORE	Item no.	MSRP (€)
Powerbank Flex5			•			502511	39.90
Powerbank Flex10			•			502127	69.90
Color Filter Set 32mm	•	•				502307	18.90
Color Filter Set 40mm			•			502308	18.90
Color Filter Set 47mm				•		502309	19.90
Headband mit Overheadband CORE	•	•	•	•	•	502469	9.90
Headband mit Overheadband WORK	•	•	•	•	•	502470	9.90
Headband mit Overheadband SIGNATURE	•	•	•	•	•	502471	12.90
Wireless Remote Control Type A (can only be used in conjunction with Bluetooth® 2x 21700 Batterybox - 502411)				•		502311	34.90
Helmet Band Fixing Clips Type A	•	•	•	•	•	502313	4.90
Transparent Silicone Headband Type A	•	•	•	•	•	502451	9.90
Magnetic Charging Cable Type A		•	•	•	•	502265	6.90
Extension Cable Type C				•	•	502312	9.90
USB Adapter 2.4A		•	•	•	•	502271	14.90
21700 Li-ion Rechargeable Battery 4800mAh			•			502262	24.90
2x 21700 Li-ion Rechargeable Battery Pack				•	•	502310	39.90
Bluetooth® 2x 21700 Batterybox				•	•	502411	59.90

\* This product is not affiliated with GoPro Inc. or its products and services. services. GoPro is a registered trademark of GoPro, Inc.





# HOME & LIFE KIDSLIGHTS





# KIDSLIGHTS

## LIGHT, FUN AND SAFETY

The lights of the KidsLights series from Ledlenser specifically address the needs and requirements of children. They offer a wide range of uses, from the self-made cave to the safe way to school, a multitude of colorful light functions, quick and easy operation, and practical energy-saving features. And the most important thing: Safety always comes first. For example, thanks to reduced luminous fluxes, minimized glare effects or safety headbands that open automatically.



**Versatile:** white light, red light and blue light with optional flashing functions (red and blue)

**Clever:** Optics with reduced glare for children's sensitive eyes

**Energy-saving:** automatic switch-off after 20 minutes (optional)



**Practical:** integrated metal clip for further attachment options without headband (e.g. on school satchel, backpack, clothing)



**Safe:** Pressure sensitive headband that releases automatically to prevent accidental injury



**KIDLED2\***  
AAA alkaline batteries



**KIDLED4R\*** rechargeable  
Rechargeable



LED			
LED-Configuration	1x Power LED (White), 1x LED (Red), 1x LED (Blue)		1x Power LED (White), 1x LED (Red), 1x LED (Blue)
Light Functions	Power (White), Low Power (White), (Power (Red), Blink (Red), Power (Blue), Blink (Blue), Blink (Red / Blue))		Power (White), Low Power (White), (Power (Red), Blink (Red), Power (Blue), Blink (Blue), Blink (Red / Blue))
Luminous Flux <sup>1</sup> (lm)	40 / 5		40 / 5
Beam Distance <sup>1</sup> (m)	9 / 2		9 / 2
Run Time <sup>1</sup> (h)	1.5 / 20		2 / 18
BATTERY AND CASE			
Battery	1 x AAA Alkaline 1.5V		1 x Li-ion 3.7V (intern)
Battery Capacity <sup>2</sup> (Wh / mAh)	-		1.036/280
Rechargeable	No		Yes
Charging Time <sup>5</sup> (min)	-		60
IP Level	IPX4		IP56
SIZE AND WEIGHT			
Diameter (mm)	54		37
Weight incl. Battery (g / oz)	35 / 1.2		25 / 0.9
FEATURES			
	White Light, Red Light, Blue Light, Automatic Switch-Off (Optional), Safety Headband, Metal Clip for Mounting as Clip Light		White Light, Red Light, Blue Light, Automatic Switch-Off (Optional), Safety Headband, Metal Clip for Mounting as Clip Light, Charge Indicator
PACKAGING (BOX)			
Item no. / GTIN	502537 (Green) / 4058205027038		502535 (Green) / 4058205026970
Item no. / GTIN	502538 (Purple) / 4058205027069		502536 (Purple) / 4058205027007
Contents Box	1 Set of Batteries		Micro-USB Charging Cable
Price (MSRP) in €	<b>15.90</b>		<b>19.90</b>

\* Caution: Not suitable for children under 36 months. Caution: Use under direct adult supervision.

<sup>1-8</sup> Information on page 176





# KIDSLIGHTS



## KIDBEAM4

AAA alkaline batteries



### Exploring with your first own flashlight:

The robust Kidbeam4 lights up in four different colors and impresses with practical, child-specific features such as the integrated clip or the automatic switch-off function.



## KIDCAMP6

AAA alkaline batteries



### For cozy evenings of playing or reading:

The Kidcamp6 provides the right mood light in four different colors and can be mounted in various ways thanks to the fold-out hook, e.g. in a tent or caravan.



	KIDBEAM4*	KIDCAMP6*
<b>LED</b>		
LED-Configuration	1x Power LED (White), 1x LED (Red), 1x LED (Blue), 1x LED (Green)	1x Power LED (White), 1x LED (Red), 1x LED (Blue), 1x LED (Green)
Light Functions	Power (White) / Low Power (White) (+ Power (Red), Power (Blue), Power (Green), Blink (Red und Blue))	Power (White) / Low Power (White) (+ Power (Red), Power (Blue), Power (Green), Blink (Red, Blue und Green))
Luminous Flux <sup>1</sup> (lm)	70 / 10	60 / 10
Beam Distance <sup>1</sup> (m)	12 / 5	- / -
Run Time <sup>1</sup> (h)	4 / 18	8 / 40
<b>BATTERY AND CASE</b>		
Battery	2 x AAA Alkaline 1.5V	3 x AAA Alkaline 1.5V
Battery Capacity <sup>2</sup> (Wh / mAh)	-	-
Rechargeable	No	No
Charging Time <sup>5</sup> (min)	-	-
IP Level	IP44	IP44
<b>SIZE AND WEIGHT</b>		
Diameter (mm)	35	75
Weight incl. Battery (g / oz)	72 / 2.5	95 / 3.4
<b>FEATURES</b>		
	White Light, Red Light, Blue Light, Green Light, Automatic Switch-Off (Optional), Clip	White Light, Red Light, Blue Light, Green Light, Automatic Switch-Off (Optional), Fold-Out Hook for Hanging Up the Light
<b>PACKAGING (BOX)</b>		
Item no. / GTIN	502754 (Green) / 4058205030861	502753 (Green) / 4058205030847
Item no. / GTIN	502789 (Purple) / 4058205031653	502786 (Purple) / 4058205031561
Contents Box	1 set of batteries	1 set of batteries
Price (MSRP) in €	<b>19.90</b>	<b>18.90</b>

\* Caution: Not suitable for children under 36 months. Caution: Use under direct adult supervision.

<sup>1-8</sup> Information on page 176



# — WORK & PROFESSIONAL FLASHLIGHTS

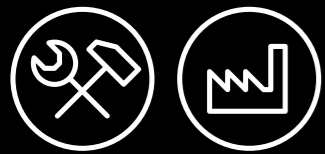

 **LEDLENSER**





# HANDY AND ROBUST LIGHTS



## P2R WORK

## P4R WORK

LED		
LED-Configuration	1x Power LED	1x Power LED
Light Functions	Power / Mid Power / Low Power	Power / Mid Power / Low Power
Luminous Flux <sup>1</sup> (lm)	110 / 50 / 15	170 / 70 / 15
Beam Distance <sup>1</sup> (m)	90 / 60 / 20	100 / 65 / 20
Run Time <sup>1</sup> (h)	0.5 / 1.5 / 7	1.25 / 3 / 15
Color Temperature (K)	4200 - 4500	4200 - 4500
Color Rendering Index (CRI)	80	80
BATTERY AND CASE		
Battery	1x Li-ion Akkupack 3.7V	1x Li-ion Akkupack 3.7V
Battery Capacity <sup>2</sup> (Wh / mAh)	1.8 / 320	2.77 / 750
IP Level	IP54	IP54
Rechargeable	Yes	Yes
Charging Time <sup>5</sup> (min)	150	150
Drop height (m)	2	2
SIZE AND WEIGHT		
Length – Defocused (mm)	120	164
Head Diameter (mm)	15	15
Weight incl. Battery (g / oz)	44 / 1.6	62 / 2.2
TECHNOLOGY		
Smart Light Technology		
Flex Sealing Technology		
Magnetic Charge System	●	●
Temperature Control		
Advanced Focus System	●	●
More Features	Energy Saving, Charge Indicator	Energy Saving, Charge Indicator
PACKAGING		
Item no. Box / GTIN	502183 / 4058205020572	502184 / 4058205020602
Contents Box	1 Battery Set, Belt Pouch, Lanyard, Magnetic Charging Cable, Pocket Clip	1 Battery Set, Belt Pouch, Lanyard, Magnetic Charging Cable, Pocket Clip
Price (MSRP) in €	<b>39.90</b>	<b>54.90</b>
OPTIONAL ACCESSORIES		
further accessories on page 68	502248 Lamp Adapter Type A	502248 Lamp Adapter Type A



## P5R WORK

LED	1x High Power LED
Light Functions	Boost / Power / Mid Power / Low Power (+ Position, Blink, S.O.S., Strobe)
Luminous Flux <sup>1</sup> (lm)	480 / 320 / 120 / 15
Beam Distance <sup>1</sup> (m)	240 / 165 / 100 / 30
Run Time <sup>1</sup> (h)	- / 1 / 3 / 25
Color Temperature (K)	3700 - 4400
Color Rendering Index (CRI)	70
BATTERY AND CASE	
Battery	1x 14500 Li-ion Akku 3.7V
Battery Capacity <sup>2</sup> (Wh / mAh)	2.77 / 750
IP Level	IP68
Rechargeable	Yes
Charging Time <sup>5</sup> (min)	120
Drop height (m)	3
SIZE AND WEIGHT	
Length – Defocused (mm)	132
Head Diameter (mm)	38
Weight incl. Battery (g / oz)	124 / 4.4
TECHNOLOGY	
Smart Light Technology	●
Flex Sealing Technology	●
Magnetic Charge System	●
Temperature Control	●
Advanced Focus System	●
More Features	Chemical Resistant, Dimmable, Transportation Lock, Flicker-free, Memory Mode, Backup Mode, Emergency Light, Battery Indicator, Charge Indicator, Low Battery Warning
PACKAGING	
Item no. Box / GTIN	502185 / 4058205020633
Contents Box	1 Battery Set, Intelligent Clip, Charging Station, Belt Pouch, Lanyard, Power Adapter, Magnetic Charging Cable
Price (MSRP) in €	<b>84.90</b>
OPTIONAL ACCESSORIES	
further accessories on page 68	502254 Helmet Mount für Euroslot

<sup>1-8</sup> Information on page 176

# P-SERIES WORK





# P7R WORK

# THE P-SERIES INDESTRUCTIBLE LIGHT FOR PROFESSIONALS



☀️ 1200 lm<sup>1</sup>  
 ➡️ 240 m<sup>1</sup>  
 ⌚ 60 h<sup>1</sup>

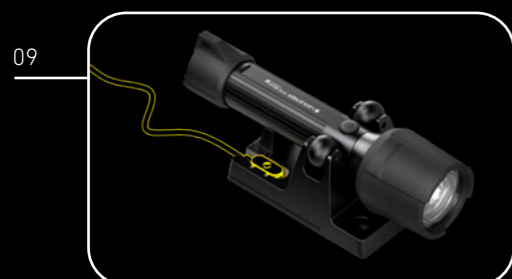
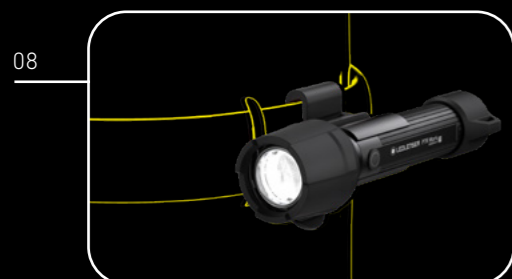

- 01** – Powerful work flashlight with **customizable light functions** and **natural color rendering (90 CRI / 4000K)**
- 02** – **Flicker-free** – Flicker-free, constant light enables strobe-free illumination, for fast-moving parts and machines
- 03** – **Protective elements on the lamp head and the end cap** absorb impacts and increase slip resistance; **the additional front lens cover** protects the lens from scratching
- 04** – Improved **chemical resistance** of the entire flashlight
- 05** – **Advanced Focus System** – stepless focusing
- 06** – Extreme **dust and water protection (IP68)**
- 07** – **White secondary light** on the side of the housing for diffuse illumination at close range
- 08** – **Ledlenser Connecting System** – one interface for many accessories (see page 16)
- 09** – **Robust charging station** - suitable for installation in a vehicle and compatible with the 5 station charging panel
- 10** – **Constant Light** – Constant luminous flux over a long period

<sup>1-8</sup> Information on page 176





# HIGH-PERFORMANCE POWER PACKS



**P6R WORK**



**P7R WORK**



PRODUCT VIDEO

LED		
LED-Configuration	1x Xtreme LED, (1x Low Power LED)	1x Xtreme LED, (1x Low Power LED)
Light Functions	Boost / Power / Mid Power / Low Power (+ Position, Blink, S.O.S., Strobe)	Boost / Power / Mid Power / Low Power (+ Position, Blink, S.O.S., Strobe)
Luminous Flux <sup>1</sup> (lm)	850 / 700 / 300 / 15	1200 / 900 / 390 / 15
Beam Distance <sup>1</sup> (m)	230 / 190 / 115 / 20	240 / 180 / 115 / 15
Run Time <sup>1</sup> (h)	- / 1.5 / 2.5 / 45	- / 2 / 3.25 / 60
Color Temperature (K)	3700 - 4400	3700 - 4400
Color Rendering Index (CRI)	90	90
BATTERY AND CASE		
Battery	1x 18650 Li-ion Akku 3.6V	1x 21700 Li-ion Akku 3.7V
Battery Capacity <sup>2</sup> (Wh / mAh)	10.89 / 3000	17.76 / 4800
IP Level	IP68	IP68
Rechargeable	Yes	Yes
Charging Time <sup>5</sup> (min)	225	270
Drop height (m)	3	3
SIZE AND WEIGHT		
Length – Defocused (mm)	163	170
Head Diameter (mm)	45	45
Weight incl. Battery (g / oz)	187 / 6.6	219 / 7.7
TECHNOLOGY		
Smart Light Technology	●	●
Flex Sealing Technology	●	●
Natural Light	●	●
Multi-Core Optics	●	●
Advanced Focus System	●	●
More Features	White Alternate Light, Magnetic Charge System, Temperature Control, Chemical Resistant, Dimmable, Transportation Lock, Flicker-free, Memory Mode, Backup Mode, Emergency Light, Battery Indicator, Charge Indicator, Low Battery Warning	White Alternate Light, Magnetic Charge System, Temperature Control, Chemical Resistant, Dimmable, Transportation Lock, Flicker-free, Memory Mode, Backup Mode, Emergency Light, Battery Indicator, Charge Indicator, Low Battery Warning
PACKAGING		
Item no. Box / GTIN	502186 / 4058205020664	502187 / 4058205020695
Contents Box	1 Battery Set, Intelligent Clip, Charging Station, Belt Pouch, Lanyard, USB Power Adapter, Magnetic Charging Cable	1 Battery Set, Intelligent Clip, Charging Station, Belt Pouch, Lanyard, USB Power Adapter, Magnetic Charging Cable
Price (MSRP) in €	<b>109.00</b>	<b>145.00</b>

Further accessories on page 68



**P18R WORK**



LED-Configuration	3x Xtreme LED
Light Functions	Boost / Power / Mid Power / Low Power (+ Position, Blink, S.O.S., Strobe)
Luminous Flux <sup>1</sup> (lm)	4500 / 2600 / 1000 / 30
Beam Distance <sup>1</sup> (m)	720 / 420 / 260 / 50
Run Time <sup>1</sup> (h)	- / 2.5 / 4.5 / 70
Color Temperature (K)	4700 - 5500
Color Rendering Index (CRI)	70
Battery	1x Li-ion Akkupack 11.1V
Battery Capacity <sup>2</sup> (Wh / mAh)	33.3 / 3000
IP Level	IP54
Rechargeable	Yes
Charging Time <sup>5</sup> (min)	330
Drop height (m)	1
Length – Defocused (mm)	183
Head Diameter (mm)	99
Weight incl. Battery (g / oz)	669 / 23.6
Smart Light Technology	●
Flex Sealing Technology	●
Natural Light	●
Multi-Core Optics	●
Advanced Focus System	●
More Features	X-Lens Technology, Magnetic Charge System, Rapid Focus, Dimmable, Transportation Lock, Flicker-free, Memory Mode, Backup Mode, Emergency Light, Battery Indicator, Charge Indicator, Low Battery Warning
Item no. Box / GTIN	502188 / 4058205020725
Contents Box	1 Battery Set, Lanyard, USB Power Adapter, Magnetic Charging Cable
Price (MSRP) in €	<b>269.00</b>

<sup>1-8</sup> Information on page 176

# P18R WORK



- 01 – X-Lens Technology** – precise synchronization of the beams from several reflector lenses to form an extremely homogeneous, stage-like floodlight or a very sharply bundled high beam
- 02 – Protective elements on the lamp head and the end cap** absorb impacts and increase slip resistance; **the additional front lens cover** protects the lens from scratching
- 03 – Flicker-free** – flicker-free, constant light enables optimal and safe illumination of fast-moving parts and machines
- 04** – Personalize the light functions thanks to the **Smart Light Technology**
- 05 – Advanced Focus System** – stepless focusing
- 06** – Convenient and safe charging of the battery thanks to the **Magnetic Charge System**



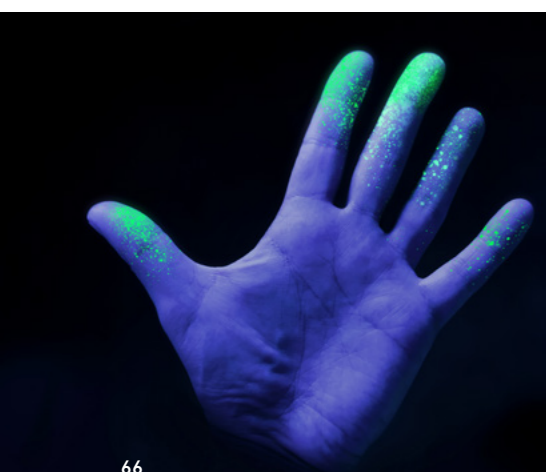
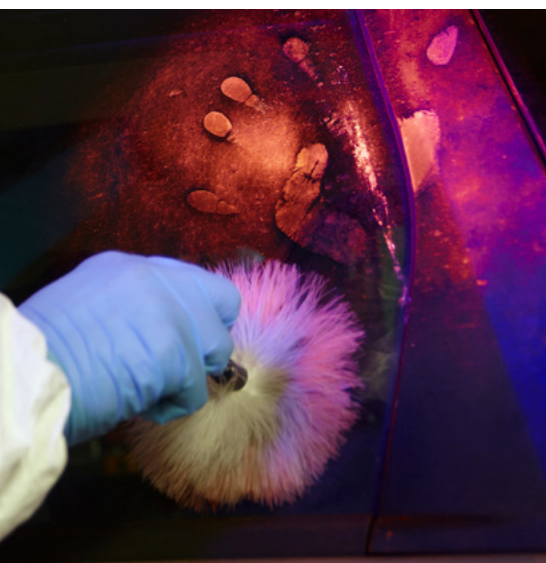

# P7R WORK UV



## P7R WORK UV

LED	
🔦 LED-Configuration	1x Xtreme LED, (1x UV LED 365nm)
🔊 Light Functions	Boost / Power / Mid Power / Low Power (+ Position, Blink, S.O.S., Strobe)
☀️ Luminous Flux <sup>1</sup> (lm)	1200 / 900 / 390 / 15
📏 Beam Distance <sup>1</sup> (m)	240 / 180 / 115 / 15
🕒 Run Time <sup>1</sup> (h)	- / 2 / 3.25 / 60
🌡️ Color Temperature (K)	3700 - 4400
📊 Color Rendering Index (CRI)	90
BATTERY AND CASE	
🔋 Battery	1x 21700 Li-ion Akku 3.7V
🔋 Battery Capacity <sup>2</sup> (Wh / mAh)	17.76 / 4800
☁️ IP Level	IP68
🔌 Rechargeable	Yes
🕒 Charging Time <sup>5</sup> (min)	270
⬇️ Drop height (m)	3
SIZE AND WEIGHT	
📏 Length – Defocused (mm)	170
📏 Head Diameter (mm)	45
📏 Weight incl. Battery (g / oz)	219 / 7.7
TECHNOLOGY	
🔦 Smart Light Technology	●
🔧 Flex Sealing Technology	●
🌞 Natural Light	●
🌐 Multi-Core Optics	●
🎯 Advanced Focus System	●
More Features	UV-Licht, Magnetic Charge System, Temperature Control, Chemical Resistant, Dimmable, Transportation Lock, Flicker-free, Memory Mode, Backup Mode, Emergency Light, Battery Indicator, Charge Indicator, Low Battery Warning
PACKAGING	
Item no. Box / GTIN	502601 / 4058205028585
Contents Box	1 Battery Set, Intelligent Clip, Charging Station, Belt Pouch, Lanyard, USB Power Adapter, Magnetic Charging Cable
<b>Price (MSRP) in €</b>	<b>145.00</b>

Further accessories on page 68

<sup>1-8</sup> Information on page 176

# ULTRAVIOLET LIGHT CHOICE

In addition to the powerful light output and particularly natural color rendering, the P7R Work UV has an additional, high-contrast UV light on the side of the housing serving, for instance, to check the authenticity of documents, for hygiene control or even for tracing.

**01 – Extremely powerful** and versatile work flashlight with natural color rendering (CRI 90)

**02 – Additional, high-contrast UV light** (wavelength: 365 nm) on the side of the housing, useful when checking documents or searching for liquids



**03 – Rubber covers on the light head and end cap protect** against impact and offer increased grip; lens shield protects the lens from impact and dirt

**04 – Robust charging station** also is suitable for mounting in the vehicle or on the Ledlenser 5 Station Charging Panel

**05 – Advanced Focus System –** for efficient, precise flood and spot lighting

**06 – Extreme dust and water protection** IP68





# ACCESSORIES

## FLASHLIGHTS

### P-SERIES WORK

#### LEDLENSER CONNECTING SYSTEM

MODEL	P2R WORK	P4R WORK	P5R WORK	P6R WORK	P7R WORK	P7R WORK UV	Item no.	MSRP (€)
Lamp Adapter Type A	•	•					502248	4.90
Lamp Adapter Type B			•				502249	4.90
Lamp Adapter Type C				•			502250	4.90
Lamp Adapter Type D					•	•	502251	4.90
Adapter suitable for GoPro** Type D	•	•	•	•	•	•	502246	7.90
Adapter suitable for Tripod Type D	•	•	•	•	•	•	502247	9.90
Belt Clip Type A	•	•	•	•	•	•	502253	6.90
Helmet Mount for Euroslot Type A	•	•	•	•	•	•	502254	6.90
Flexible Mount Type A	•	•	•	•	•	•	502255	14.90
Universal Mounting Bracket Type E	•	•	•	•	•	•	502256	12.90

#### Lamp Adapter Type A-D

##### Mounting adapter (Requirement)

The adapter enables the connection between flashlights and the versatile LEDLENSER CONNECTING SYSTEM. Now the light is compatible with various additional accessory brackets and mounts.

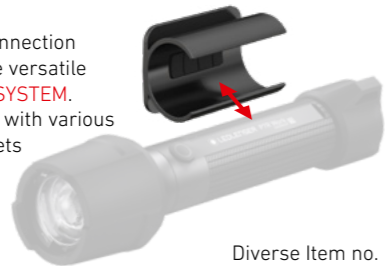

Diverse Item no. €4.90 (MSRP)

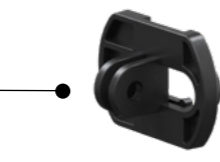

Item no. 502246  
**Adapter suitable for GoPro\*\***  
Compatible with almost all GoPro\*\* systems and accessories  
€7.90 (MSRP)



Item no. 502255  
**Flexible Mount**  
Flexible fastening system with magnet, adhesive pad and hole to screw on  
€14.90 (MSRP)



Item no. 502254  
**Helmet Mount for Euroslot**  
Hard hat mount for 30 mm Euroslot €6.90 (MSRP)



Item no. 502256  
**Universal Mounting Bracket**  
Stable universal fastening to cylindrical objects €12.90 (MSRP)



Item no. 502247  
**Adapter suitable for Tripod**  
€9.90 (MSRP)



Item no. 502253  
**Belt Clip Type A**  
Belt clip for lights and battery packs €6.90 (MSRP)



Item no. 502511  
**Powerbank Flex5**  
More information on page 152  
€39.90 (MSRP)



Item no. 502125  
**Powerbank Flex7**  
More information on page 152  
€54.90 (MSRP)



Item no. 502127  
**Powerbank Flex10**  
More information on page 152  
€69.90 (MSRP)



Multiple sizes / item no's.  
**Charging Station**  
professional charging station including magnetic charging cable, compatible with 5 station charging panel  
€12.90 (MSRP)



Item no. 502261  
**5 Station Charging Panel**  
Charge up to five compatible Ledlenser Lights (requirement: matching charging station)  
€69.90 (MSRP)

#### ACCESSORIES POWER SUPPLY

MODEL	P2R WORK	P4R WORK	P5R WORK	P6R WORK	P7R WORK	P7R WORK UV	P18R WORK	Item no.	MSRP (€)
Powerbank Flex3				•				502126	34.90
Powerbank Flex5					•	•		502511	39.90
Powerbank Flex7				•				502125	54.90
Powerbank Flex10					•	•		502127	69.90
Magnetic Charging Cable Type A	•	•	•	•	•	•	•	502265	6.90
Wall Mount Type A (magnetic charge cable included)				•				502257	9.90
Wall Mount Type B (magnetic charge cable included)					•	•		502258	9.90
Charging Station Type A (magnetic charge cable included)			•					502259	12.90
Charging Station Type B (magnetic charge cable included)				•	•	•		502260	12.90
5 Station Charging Panel			•	•	•	•		502261	69.90
USB Adapter 2.4A	•	•	•	•	•	•	•	502271	14.90
USB Car Charger	•	•	•	•	•	•	•	0380	9.90
21700 Li-ion rechargeable battery 4800mAh					•	•		502262	24.90
14500 Li-ion rechargeable battery 750 mAh			•					500985	12.90
18650 Li-ion rechargeable battery 3000 mAh				•				501001	24.90
Li-ion direct USB rech. bat. 2500 mAh				•				502595	24.90
Li-ion direct USB rech. bat. 880 mAh			•					502596	17.90

\* This product is not affiliated with GoPro Inc. or its products and services. services. GoPro is a registered trademark of GoPro, Inc.



# ACCESSORIES

## FLASHLIGHTS

### P-SERIES WORK

#### POUCHES / FILTERS / MOUNTS AND MORE

MODEL	P2R WORK	P4R WORK	P5R WORK	P6R WORK	P7R WORK	P7R WORK UV	P18R WORK	Item no.	MSRP (€)
Signal Cone 42mm				•	•	•		500958	6.90
Signal Cone White 42mm				•	•	•		502244	9.90
Roll Protection 85,5mm							•	502242	14.90
Case Type A	•	•	•	•	•	•		502263	24.90
Case Type B	•	•	•	•	•	•		502264	29.90
Pouch Type O				•	•	•		502268	9.90
Pouch Type D	•							0337	9.90
Pouch Type A			•					0333	9.90
Universal Mounting System				•	•	•		0362	14.90



Item no.502264  
**Case Type B**  
 With this high-quality, **fabric-covered hard case**, the Ledlenser light and accessories are always safely stored and protected from dust and external influences. Inside there are elastic loops and a mesh pocket to stow the light, Powerbank and other accessories.  
 (Size 200mm x 135mm x 72mm)  
**€29.90 (MSRP)**



Item no.0362  
**Universal Mounting System**  
 This universal mounting fixes flashlights with a diameter of 25-34 mm securely to tripods, rods and tubes in next to no time. The light and fixation are aligned in parallel.  
**€14.90 (MSRP)**

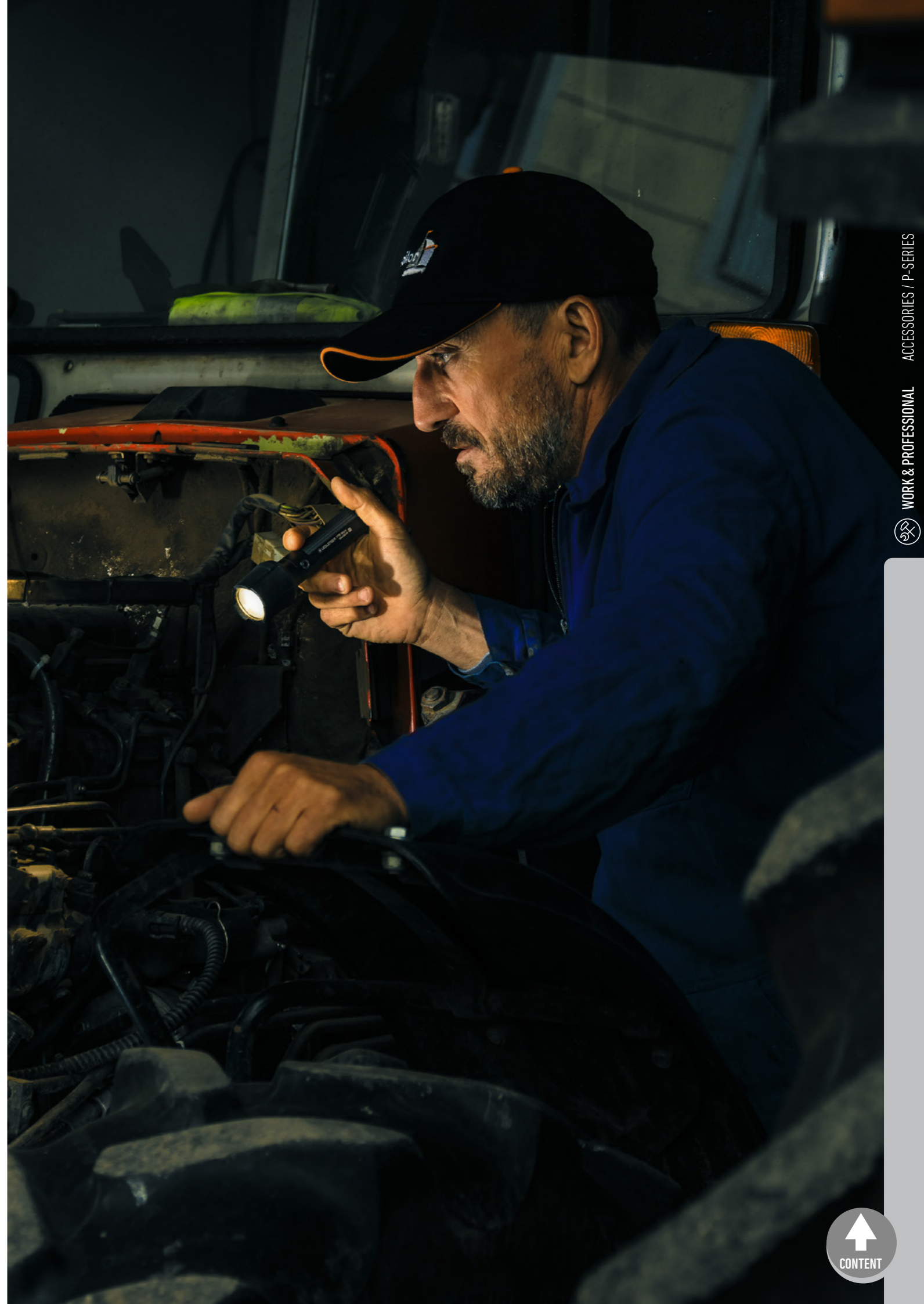



# WORK & PROFESSIONAL HEADLAMPS



 LEDLENSER

WORK & PROFESSIONAL



CONTENT



# H15R WORK

## THE H-SERIES THE WORKHORSE AMONG THE HEADLAMPS

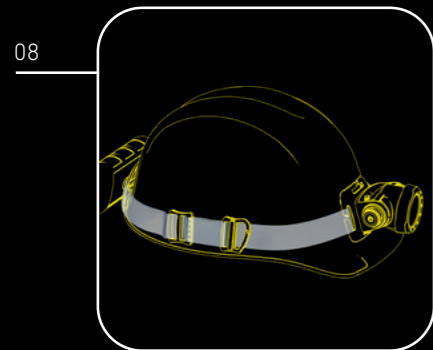
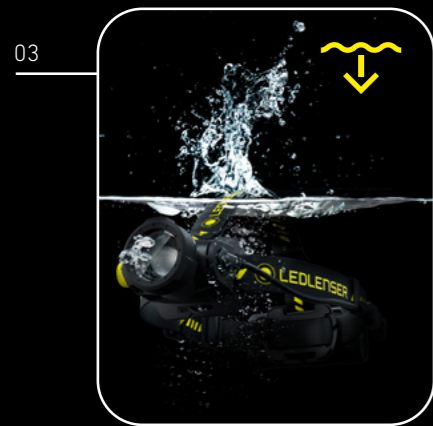

PRODUCT VIDEO

☀️ 2500 lm<sup>1</sup>  
 ➡️ 250 m<sup>1</sup>  
 ⌚ 70 h<sup>1</sup>

- 01** – Extremely powerful, focusable work headlamp: **high color rendering, neutral white light**
- 02** – Strong **dust and water protection (IP67)**
- 03** – **Flicker-free** – Flicker-free, constant light enables strobe-free illumination, for fast-moving parts and machines
- 04** – **Protective elements on the lamp head and the end cap** absorb impacts and increase slip resistance; **the additional front lens cover** protects the lens from scratching
- 05** – Intuitive operation and stepless dimming thanks to **Wheel Switch** on the lamp head
- 06** – Stepless **swivel mechanism** for vertical alignment of the light cone
- 07** – **Ledlenser Connecting System** – an interface for many accessories (see page 22)
- 08** – **Extensive accessories** for versatile use, e.g. mounting clips, focusing ring, belt clip, transparent silicone headband, extension cord
- 09** – Convenient and safe charging of the battery thanks to the **Magnetic Charge System**

**GIT**  
**SICHERHEIT**  
**AWARD**  
 2022  
 FINALIST



<sup>1-8</sup> Information on page 176





# H-SERIES WORK



## LED

	LED-Configuration
	Light Functions
	Luminous Flux <sup>1</sup> (lm)
	Beam Distance <sup>1</sup> (m)
	Run Time <sup>1</sup> (h)
	Color Temperature (K)
	Color Rendering Index (CRI)

## BATTERY AND CASE

	Battery
	Battery Capacity <sup>2</sup> (Wh / mAh)
	IP Level
	Rechargeable
	Charging Time <sup>5</sup> (min)
	Drop height (m)

## SIZE AND WEIGHT

	Head Diameter (mm)
	Weight incl. Battery (g / oz)

## TECHNOLOGY

	Multi-Core Optics
	Flex Sealing Technology
	Magnetic Charge System
	Natural Light
	Advanced Focus System

More Features

## PACKAGING

Item no. Box / GTIN
Contents Box

Price (MSRP) in €

## OPTIONAL ACCESSORIES

[further accessories on page 78](#)

H5R WORK	H7R WORK	H15R WORK
1x High Power LED	1x Xtreme LED	1x Xtreme LED
Boost / Power / Low Power	Boost / Power / Low Power	Boost / Power / Low Power
500 / 300 / 15	1000 / 600 / 15	2500 / 1000 / 20
200 / 150 / 30	250 / 200 / 25	250 / 170 / 20
- / 2 / 45	- / 4 / 60	- / 4 / 70
3700 – 4400	3700 – 4400	3700 – 4400
80	90	90
1x Li-ion Akkupack 3.7V	1x 21700 Li-ion Akku 3.7V	1x Li-ion Akkupack 7.4V
6.66 / 1800	17.76 / 4800	35.52 / 4800
IP67	IP67	IP67
Yes	Yes	Yes
210	210	330
3	3	3
38	46	51
188 / 6.6	282 / 9.9	413 / 14.6
●	●	●
●	●	●
●	●	●
●	●	●
●	●	●
Cooling Technology, Temperature Control, Dimmable, Transportation Lock, Flicker-free, Memory Mode, Backup Mode, Battery Indicator, Charge Indicator, Low Battery Warning, Constant Light	Cooling Technology, Temperature Control, Dimmable, Transportation Lock, Flicker-free, Memory Mode, Backup Mode, Battery Indicator, Charge Indicator, Low Battery Warning, Constant Light	Cooling Technology, Dimmable, Transportation Lock, Flicker-free, Memory Mode, Backup Mode, Battery Indicator, Charge Indicator, Low Battery Warning, Constant Light
502194 / 4058205020992	502195 / 4058205021029	502196 / 4058205021050
1 Battery Set, Magnetic Charging Cable, Mounting Clips, Focusing Ring, Transparent Silicone Tape	1 Battery Set, Magnetic Charging Cable, Mounting Clips, Focusing Ring, Transparent Silicone Tape, Extension Cable, Belt Clip	1 Battery Set, Magnetic Charging Cable, Mounting Clips, Focusing Ring, Transparent Silicone Tape, Extension Cable, Belt Clip
<b>94.90</b>	<b>135.00</b>	<b>199.00</b>
502314 Helmet Connecting Kit Type H	502262 21700 Li-Ion Rech. Bat.	502256 Universal Mounting Bracket
502247 Adapter suitable for Tripod Type D	502410 Bluetooth® Batterybox	502411 Bluetooth® Batterybox

<sup>1-8</sup> Information on page 176



**GIT**  
**SICHERHEIT**  
**AWARD**  
**2022**  
**FINALIST**



# ACCESSORIES

## HEADLAMPS

## H-SERIES WORK

### LEDLENSER CONNECTING SYSTEM

MODEL	H5R WORK	H7R WORK	H15R WORK	Item no.	MSRP (€)
Adapter suitable for GoPro** Type D	•	•	•	502246	7.90
Adapter suitable for Tripod Type D	•	•	•	502247	9.90
Belt Clip Type A	•	•	•	502253	6.90
Helmet Connecting Kit Type H	•	•	•	502314	14.90
Universal Mounting Bracket Type E	•	•	•	502256	12.90

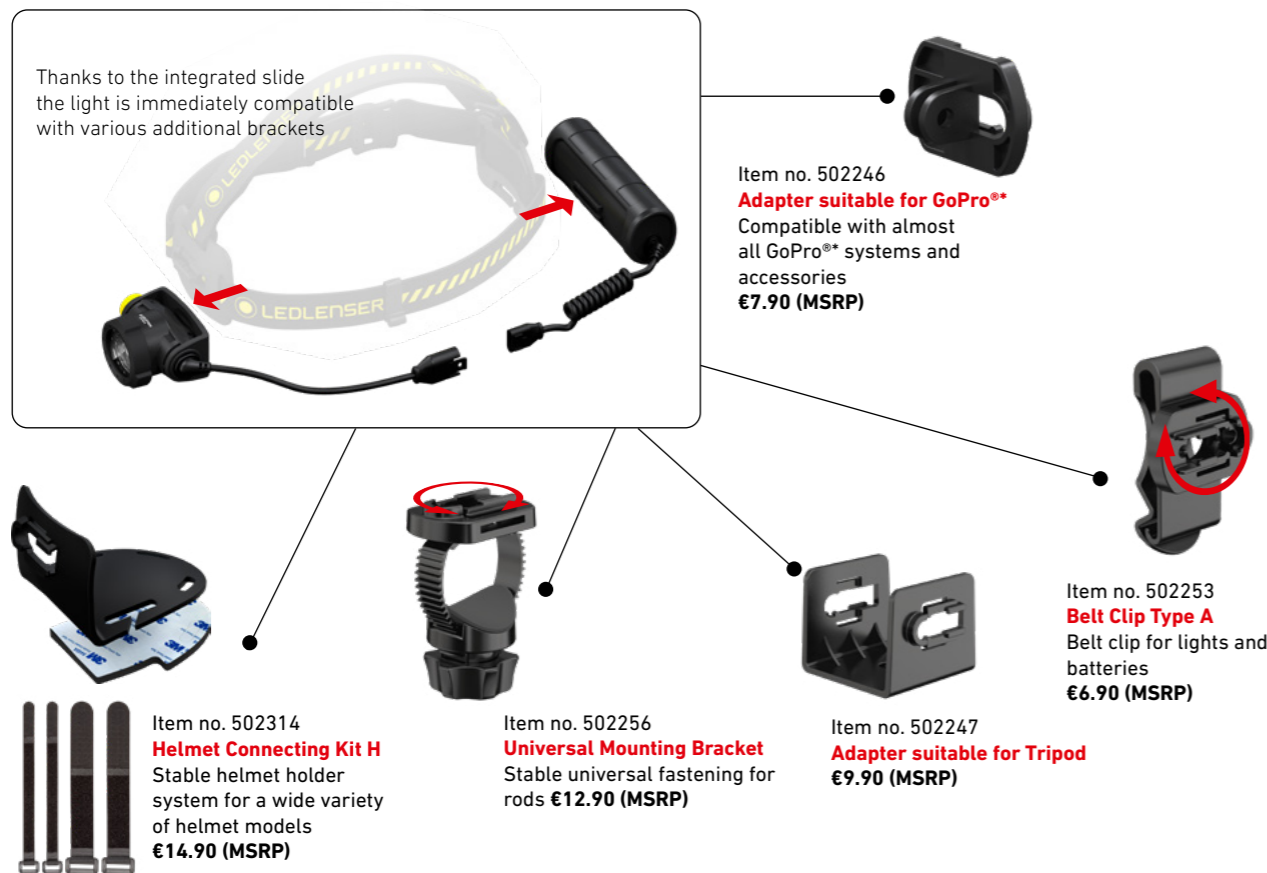

Thanks to the integrated slide the light is immediately compatible with various additional brackets

Item no. 502246  
**Adapter suitable for GoPro\*\***  
Compatible with almost all GoPro\*\* systems and accessories  
€7.90 (MSRP)

Item no. 502253  
**Belt Clip Type A**  
Belt clip for lights and batteries  
€6.90 (MSRP)

Item no. 502314  
**Helmet Connecting Kit H**  
Stable helmet holder system for a wide variety of helmet models  
€14.90 (MSRP)

Item no. 502256  
**Universal Mounting Bracket**  
Stable universal fastening for rods  
€12.90 (MSRP)

Item no. 502247  
**Adapter suitable for Tripod**  
€9.90 (MSRP)



Multiple sizes / item no's.  
**Color Filter Set**  
Four high quality color filters: Red maintains night vision. Green and red are among others suitable for wildlife viewing. Yellow improves visibility in fog. Blue improves the visibility of liquids  
€18.90 - €19.90 (MSRP)



Item no. 502411  
**Bluetooth® 2x 21700 Batterybox**  
Upgrade to smart control: Bluetooth®  
Li-ion battery box for use with the Ledlenser Connect app or with the additional available remote control  
€59.90 (MSRP)



Item no. 502312  
**Extension Cable**  
Practical extension cable (120 cm) that is plugged in between the lamp head and the battery box - so the battery can easily be stowed in the backpack  
€9.90 (MSRP)



Item no. 502451  
**Transparent Silicone Headband**  
Elastic headband made of transparent silicone: Excellent grip, durability and easy to use. Due to the transparent material, safety-relevant information remains visible on the helmet  
€9.90 (MSRP)

### COLOR FILTERS / CABLES / BATTERIES AND MORE

MODEL	H5R WORK	H7R WORK	H15R WORK	Item no.	MSRP (€)
Powerbank Flex5		•		502511	39.90
Powerbank Flex10		•		502127	69.90
Color Filter Set 32mm	•			502307	18.90
Color Filter Set 40mm		•		502308	18.90
Color Filter Set 47mm			•	502309	19.90
Headband mit Overheadband CORE	•	•	•	502469	9.90
Headband mit Overheadband WORK	•	•	•	502470	9.90
Headband mit Overheadband SIGNATURE	•	•	•	502471	12.90
Helmet Band Fixing Clips Type A	•	•	•	502313	4.90
Transparent Silicone Headband Type A	•	•	•	502451	9.90
Magnetic Charging Cable Type A	•	•	•	502265	6.90
Extension Cable Type C		•	•	502312	9.90
USB Adapter 2.4A	•	•	•	502271	14.90
21700 Li-ion Rechargeable Battery 4800mAh		•		502262	24.90
2x 21700 Li-ion Rechargeable Battery Pack		•	•	502310	39.90
Wireless Remote Control Type A (can only be used together with a Bluetooth® Batterybox (502410, 502411))		•	•	502311	34.90
Bluetooth® 21700 Batterybox		•		502410	49.90
Bluetooth® 2x 21700 Batterybox		•	•	502411	59.90

\* This product is not affiliated with GoPro Inc. or its products and services. services. GoPro is a registered trademark of GoPro, Inc.

<sup>1-8</sup> Information on page 176





# iH-SERIES



**iH3**



**iH5**

LED		
LED-Configuration	1x Power LED	1x High Power LED
Light Functions	Power / Low Power	Power / Low Power
Luminous Flux <sup>1</sup> (lm)	120 / 5	200 / 20
Beam Distance <sup>1</sup> (m)	100 / 20	130 / 40
Run Time <sup>1</sup> (h)	6 / 60	4,5 / 35

BATTERY AND CASE		
Battery	3x Micro (AAA) Alkaline 1.5V	1x Mignon (AA) Alkaline 1.5V
Battery Capacity <sup>2</sup>	-	-
Rechargeable	No	No
Charging Time <sup>5</sup> (min)	-	-
IP Level	IPX4	IP54

SIZE AND WEIGHT		
Head Diameter (mm)	28	31
Weight incl. Battery (g / oz)	133 / 4.7	92 / 3.2

TECHNOLOGY		
Magnetic Charge System		
Smart Light Technology		●
Rapid Focus		●
Dual Power Source		●
Advanced Focus System	●	●
More Features	Energy Saving, Dimmable	Low Battery Warning, Mounting System, Metallclip

PACKAGING		
Item no. Box / GTIN	500770 / 4058205000680	502024 / 4058205015998
Contents Box	1 set of batteries	1 set of batteries

Price (MSRP) in €	<b>37.90</b>	<b>37.90</b>
-------------------	--------------	--------------

OPTIONAL ACCESSORIES		
	0332 Pouch Type H	500985 14500 Li-ion rech.battery
	0359 Helmet Band Fixing Clip (4x)	500986 Charging Station
		502220 Helmet Connecting Kit Type D
		502223 Helmet Connecting Kit Type G

further accessories on page 84



**iH5R**

LED-Configuration	1x High Power LED
Light Functions	Power / Low Power
Luminous Flux <sup>1</sup> (lm)	400 / 20
Beam Distance <sup>1</sup> (m)	180 / 40
Run Time <sup>1</sup> (h)	4 / 35

Battery	1x 14500 Li-ion Akku 3.7V
Battery Capacity <sup>2</sup>	2.77 / 750
Rechargeable	Yes
Charging Time <sup>5</sup> (min)	150
IP Level	IP54

Head Diameter (mm)	31
Weight incl. Battery (g / oz)	98 / 3.5

Magnetic Charge System	●
Smart Light Technology	●
Rapid Focus	●
Dual Power Source	●
Advanced Focus System	●
More Features	Low Battery Warning, Battery Indicator, Charge Indicator, Mounting System, Metallclip

Item no. Box / GTIN	502025 / 4058205016025
Contents Box	1 Set of Batteries, Magnetic Charging Cable, Helmet Mount

Price (MSRP) in €	<b>59.90</b>
-------------------	--------------

OPTIONAL ACCESSORIES	502093 Powercase
	502220 Helmet Connecting Kit Type D
	500985 14500 Li-ion rech.battery
	500986 Charging station

<sup>1-8</sup> Information on page 176

DYNAMIC  
ILLUMINATION  
- INSPIRING  
FROM  
ANY ANGLE



## Mounting System

Thanks to the **innovative Mounting System**, the headlamp turns into a hand-held light or clip light in no time at all







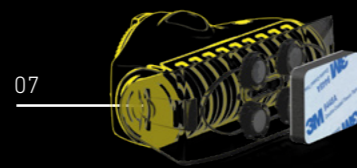

# iH11R







- 01** – Ledlenser Connect App enables personalization and remote control of the light functions
- 02** – Optisense Technology – automatic adjustment of the lighting conditions thanks to the integrated sensor
- 03** – Advanced Focus System – stepless focusing
- 04** – Stepless swivel mechanism for vertical alignment of the light cone
- 05** – Additionally red light, green light and blue light available
- 06** – Various mounting options on helmets
- 07** – Magnetic holder to turn the iH11R into a hands free area light
- 08** – Convenient and safe charging of the battery thanks to the Magnetic Charge System



## LED

 LED-Configuration
 Light Functions
 Luminous Flux <sup>1</sup> (lm)
 Beam Distance <sup>1</sup> (m)
 Run Time <sup>1</sup> (h)







## BATTERY AND CASE

 Battery
 Battery Capacity <sup>2</sup> (Wh / mAh)
 Rechargeable
 Charging Time <sup>5</sup> (min)
 IP Level

## SIZE AND WEIGHT

 Head Diameter (mm)
 Weight incl. Battery (g / oz)

## TECHNOLOGY

 Magnetic Charge System
 Smart Light Technology
 Rapid Focus
 Dual Power Source
 Advanced Focus System
 Cooling Technology
 Optisense Technology

More Features

## PACKAGING

Item no. Box / GTIN
Contents Box

Price (MSRP) in €

## OPTIONAL ACCESSORIES

further accessories on page 84



## iH8R                      iH9R                      iH11R

1x Xtreme LED	1x Xtreme LED	1x Xtreme LED
Power / Mid Power / Low Power	Boost / Power / Mid Power / Low Power (+ Blink)	Boost / Power / Mid Power / Low Power (+ Blink, S.O.S., Strobe)
600 / 250 / 10	600 / 400 / 170 / 20	1000 / 750 / 300 / 10
150 / 100 / 20	200 / 180 / 120 / 40	320 / 300 / 200 / 30
10 / 15 / 120	- / 7 / 10 / 60	- / 4 / 8 / 100

1x 18650 Li-ion Battery 3.6V	1x Li-ion Battery pack 3.7V	1x 18650 Li-ion Battery 3.6V
11.52 / 3200	5.73 / 1550	11.52 / 3200
Yes	Yes	Yes
360	270	420
IP54	IP54	IP54

61	31	40
158 / 5.6	139 / 4.9	179 / 6.3

	•	•
•	•	•
•	•	•
	•	
•	•	•
	•	•
		•

Temperature Control System, Battery Indicator, Low Battery Warning, Transportation Lock, Energy Saving, Constant Light, Rear Light	Energy Saving, Constant Light, Low Battery Warning, Charge Indicator, Battery Indicator, Transportation Lock, Red Light, Green Light, Blue Light, Mounting System	Energy Saving, Constant Light, Low Battery Warning, Charge Indicator, Battery Indicator, Transportation Lock, Dimmable, Red Light, Green Light, Blue Light, Bluetooth <sup>®8</sup> , Memory Mode, Mounting System
--	---	--

500912 / 4058205010313	502023 / 4058205015967	502022 / 4058205015936
------------------------	------------------------	------------------------

1 Battery Set, Magnetic Charging Cable, Helmet Mount, Belt Pouch, Focus Ring	1 Battery Set, Magnetic Charging Cable, Helmet Mount	1 Battery Set, Magnetic Holder, Belt Pouch, Helmet Mount, Magnetic Charging Cable, Extended Mounting Set
--	--	--

<b>119.00</b>	<b>99.90</b>	<b>199.00</b>
---------------	--------------	---------------

502126 Powerbank Flex3	502221 Helmet Connecting Kit Type E	502222 Helmet Connecting Kit Type F
502125 Powerbank Flex7	502093 Powercase	501001 18650 Li-ion rech. Battery 3000 mAh

<sup>1-8</sup> Information on page 176



# WORK & PROFESSIONAL ACCESSORIES HEADLAMPS

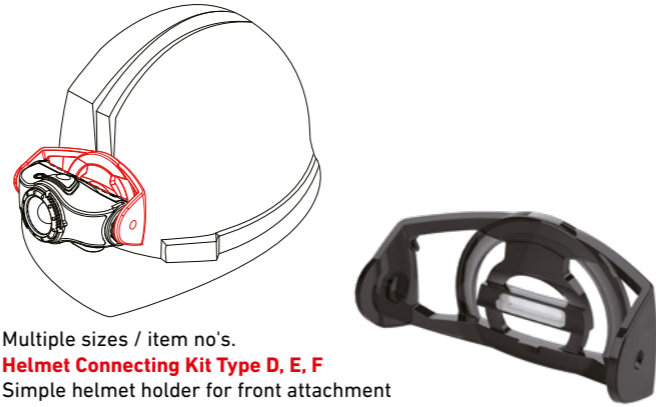

Multiple sizes / item no's.  
**Helmet Connecting Kit Type D, E, F**  
Simple helmet holder for front attachment  
to the helmet with an adhesive pad  
**€9.90 (MSRP)**



Item no. 502223  
**Helmet Connecting Kit Type G**  
Helmet holder for attaching the head-  
lamp to the helmet using a rubber  
band and plastic clips or adhesive pad  
**€14.90 (MSRP)**



Item no. 502093  
**Powercase**  
More information on page 141  
**€59.90 (MSRP)**

## ACCESSORIES POWER SUPPLY / MOUNTS AND MORE

MODEL	iH3	iH5	iH5R	iH8R	iH9R	iH11R	Item no.	MSRP (€)
Powercase			●		●		502093	49.90
Powerbank Flex3				●		●	502126	34.90
Powerbank Flex7				●		●	502125	54.90
Helmet Connecting Kit Type D		●	●				502220	9.90
Helmet Connecting Kit Type E					●		502221	9.90
Helmet Connecting Kit Type F						●	502222	9.90
Helmet Connecting Kit Type G		●	●		●	●	502223	14.90
Helmet Band Fixing Clips Type A	●	●	●	●	●	●	502313	4.90
Silicone Headband Type A				●			501595	9.90
Pouch Type H	●						0332	12.90
18650 Li-ion Rechargeable Battery 3.6V 3000 mAh				●		●	501001	24.90
Li-ion Rechargeable Battery Pack 3.7V 1550 mAh					●		500987	17.90
14500 Li-ion Rechargeable Battery 750 mAh		●	●				500985	12.90
Charging station & 14500 li-ion rechargeable battery		●	●				500986	18.90
Li-ion direct USB Rechargeable Battery 2500 mAh						●	502595	24.90



Item no. 502126  
**Powerbank Flex3**  
More information on page 152  
**€34.90 (MSRP)**



Item no. 502125  
**Powerbank Flex7**  
More information on page 152  
**€54.90 (MSRP)**



# — WORK & PROFESSIONAL WORK LIGHTS



 LEDLENSER

WORK & PROFESSIONAL





# W-SERIES NEW



W1R WORK

## LED

☰	LED-Configuration
☰	Light Functions
☀	Luminous Flux Flood <sup>1</sup> (lm)
🕒	Run Time Flood <sup>1</sup> (h)
☀	Luminous Flux Spot <sup>1</sup> (lm)
🕒	Run Time Spot <sup>1</sup> (h)
🌡	Color temperature(K)
Ⓢ	Color rendering index (CRI)

## BATTERY AND CASE

🔋	Battery
🔋	Battery Capacity <sup>2</sup> (Wh / mAh)
🔋	Rechargeable
🕒	Charging Time <sup>5</sup> (min)
☁	IP Level

## SIZE AND WEIGHT

📏	B / H / T (mm)
⚖	Weight incl. Battery (g / oz)

## FEATURES

## PACKAGING

📦	Item no. Box / GTIN
📦	Contents Box

**Price (MSRP) in €**

## OPTIONAL ACCESSORIES

# WORK MADE EASY PREMIUM WORK LIGHTS



## W1R WORK

1x COB LED
Power / Low Power
220 / 60
1.5 / 7
-
-
6000 - 7500
70

## W2 WORK

1x COB LED (Flood), 1x Xtreme LED
Power / Low Power
160 / 40
5 / 20
80
10
6000 - 7500
70

## W2R WORK

1x COB LED (Flood), 1x Xtreme LED
Power / Low Power
160 / 40
5 / 20
80
10
6000 - 7500
70

Li-ion Battery 3.7V (internal)
2.74 / 740
Yes
120
IP54

2x AAA Alkaline 1.5V
-
No
-
IP54

Li-ion Battery 3.7V (internal)
2.33 / 630
Yes
150
IP54

38 / 76 / 32
61 / 2.2

17 / 176 / 24
65 / 2.3

17 / 176 / 24
61 / 2.2

- Ultra-compact clip light
- Flexible illumination thanks to swivel joint and swivelling lamp head
- Integrated magnet for flexible positioning
- Easy to charge via USB-C

- Compact pen and test light
- Flexible operation with two AAA batteries
- Spot LED for precise illumination of details
- Flood LED for wide-area illumination

- Compact pen and test light
- Easily rechargeable via USB-C
- Spot LED for precise illumination of details
- Flood LED for wide-area illumination

502810 / 4058205032094
USB-C charging cable

502808 / 4058205032032
1 Batterypack

502809 / 4058205032063
1 Batterypack, USB-C charging cable

**29.90**

**24.90**

**34.90**

502929 USB-C Adapter 20W

500981 4x AAA Alkaline Ionic

502929 USB-C Adapter 20W

<sup>1\*</sup> Information on page 176





# W7R WORK



**NEW**

**CLEVER, POWERFUL, VERSATILE**  
THE ULTIMATE WORK LIGHT  
FOR PROFESSIONALS



☀️ 600 lm<sup>1</sup>  
🕒 5 h<sup>1</sup>

- 01** – Continuously adjustable color temperature from neutral white to cool white, e. g. for checking color fastness or to distinguish cables
- 02** – Flood LED with homogeneous premium light pattern for illuminating larger working areas
- 03** – UV light (365 nm) for locating leaks or inspecting documents
- 04** – Flexible mounting via stand, magnet or metal hook
- 05** – Plastic housing: **robust and non-slip**
- 06** – Efficient Li-ion battery, easily rechargeable via USB-C (smartphone charging cable)
- 07** – Transportation lock protects against unintentional switch-on

Technical details:





# WORK MADE EASY

## PREMIUM WORK LIGHTS

NEW



W4R Work

W5R Work



W6R Work

W7R Work

LED		
LED-Configuration	1x COB LED (Flood), 1x High Power LED (Spot)	1x COB LED (Flood), 1x Xtreme LED (Spot)
Light Functions	Power / Low Power (Flood)	Power / Low Power (Flood)
Luminous Flux Flood <sup>1</sup> (lm)	220 / 60	600 / 250
Run Time Flood <sup>1</sup> (h)	2 / 9	2 / 4
Luminous Flux Spot <sup>1</sup> (lm)	100	100
Run Time Spot <sup>1</sup> (h)	2	6.5
Color temperature(K)	6000 - 7500	6000 - 7500
Color rendering index (CRI)	80	80
BATTERY AND CASE		
Battery	Li-ion Battery 3.7V (internal)	Li-ion Battery 3.7V (internal)
Battery Capacity <sup>2</sup> (Wh / mAh)	2.8 / 760	9.2 / 2500
Rechargeable	Yes	Yes
Charging Time <sup>5</sup> (min)	120	210
IP Level	IP54	IP54
SIZE AND WEIGHT		
B / H / T (mm)	28 / 163 / 20	38 / 153 / 27
Weight incl. Battery (g / oz)	91 / 3.2	153 / 5.4
FEATURES		
	<ul style="list-style-type: none"> <li>• Compact and powerful work light</li> <li>• Flexible mounting thanks to magnet and swivel mechanism</li> <li>• 2 light sources (spot and flood)</li> <li>• Battery status indicator</li> <li>• Transport lock</li> <li>• Flicker-free</li> </ul>	<ul style="list-style-type: none"> <li>• Powerful work light for large work areas</li> <li>• Flexible mounting thanks to magnet and swivel mechanism</li> <li>• 2 light sources (spot and flood)</li> <li>• Battery status indicator</li> <li>• Transport lock</li> <li>• Flicker-free</li> </ul>
PACKAGING		
Item no. Box / GTIN	502733 / 4058205030441	502735 / 4058205030502
Contents Box	USB-C charging cable	USB-C charging cable
Price (MSRP) in €	<b>39.90</b>	<b>59.90</b>
OPTIONAL ACCESSORIES		
	502929 USB-C Adapter 20W	502929 USB-C Adapter 20W

LED		
LED-Configuration	1x COB LED (Flood), 1x High Power LED (Spot)	1x COB LED (Flood), 1x UV Light (365 nm)
Light Functions	Power / Low Power (Flood)	Power / Low Power (Flood)
Luminous Flux Flood <sup>1</sup> (lm)	500 / 220	600 / 220
Run Time Flood <sup>1</sup> (h)	2 / 6	2 / 5
Luminous Flux Spot <sup>1</sup> (lm)	120	-
Run Time Spot <sup>1</sup> (h)	10	-
Color temperature(K)	6000 - 7500	4000 - 7500
Color rendering index (CRI)	80	80
BATTERY AND CASE		
Battery	Li-ion Battery 3.7V (internal)	Li-ion Battery 3.7V (internal)
Battery Capacity <sup>2</sup> (Wh / mAh)	9.3 / 2500	9.3 / 2500
Rechargeable	Yes	Yes
Charging Time <sup>5</sup> (min)	210	210
IP Level	IP54	IP54
SIZE AND WEIGHT		
B / H / T (mm)	31 / 143 / 45	31 / 143 / 45
Weight incl. Battery (g / oz)	132 / 4.7	132 / 4.7
FEATURES		
	<ul style="list-style-type: none"> <li>• 2 light sources (spot and flood)</li> <li>• Fold-out (180°) and rotatable (270°) lamp head</li> <li>• Charging via USB-C charging cable</li> <li>• Battery and charge level indicator</li> <li>• Flexible and versatile work light</li> <li>• Flicker-free</li> </ul>	<ul style="list-style-type: none"> <li>• 2 light sources (flood and UV light for leak detection)</li> <li>• Fold-out (180°) and rotatable (270°) lamp head</li> <li>• Charging via USB-C charging cable</li> <li>• Ultimate work light for professionals</li> <li>• Flicker-free</li> </ul>
PACKAGING		
Item no. Box / GTIN	502736 / 4058205030533	502737 / 4058205030564
Contents Box	USB-C charging cable	USB-C charging cable
Price (MSRP) in €	<b>69.90</b>	<b>89.90</b>
OPTIONAL ACCESSORIES		
	502929 USB-C Adapter 20W	502929 USB-C Adapter 20W

# W-SERIES

WORK & PROFESSIONAL WORK LIGHTS





# — WORK & PROFESSIONAL FLOODLIGHTS



 LEDLENSER



# POCKET SIZE RECHARGEABLE WORK-SITE FLOODLIGHTS



## LED

△	LED-Configuration
⏏	Light Functions
☀	Luminous Flux Flood <sup>1</sup> (lm)
🕒	Run Time Flood <sup>1</sup> (h)
☀	Luminous Flux Spot <sup>1</sup> (lm)
🕒	Run Time Spot <sup>1</sup> (h)

## BATTERY AND CASE

🔋	Battery
🔋	Battery Capacity <sup>2</sup> (Wh / mAh)
🔌	Rechargeable
🕒	Charging Time <sup>5</sup> (min)
🌧	IP Level

## SIZE AND WEIGHT

📏	B / H / T (mm)
⚖	Weight incl. Battery (g / oz)

## FEATURES

- **Mini Floodlights with Floodlight** and additional **Spotlight**
- **Flexible Attachment** and Alignment thanks to the Movable Stand, Magnet and Hook
- Easy Charging with the robust **Magnetic Charge System**
- Small and Handy
- **Three Light Levels (2x Flood, 1x Spot)**

## PACKAGING

Item no. Box / GTIN
Contents Box

Price (MSRP) in €

## OPTIONAL ACCESSORIES

502265 Magnetic Charging Cable Type A
502271 USB Adapter 2.4A
0380 USB Car Charger



## iF2R

1x COB LED (Flood),  
1x Power LED (Spot)

Power / Low Power (Flood)

200 / 100

3 / 6

75

4

Li-ion Battery 3.7V (internal)

5.9 / 1600

Yes

180

IP54

115 / 21 / 48

88 / 3.1

- **Mini Floodlights with Floodlight** and additional **Spotlight**
- **Flexible Attachment** and Alignment thanks to the Movable Stand, Magnet and Hook
- Easy Charging with the robust **Magnetic Charge System**
- Small and Handy
- **Three Light Levels (2x Flood, 1x Spot)**

502170 / 4058205020206

USB Cable

49.90

502265 Magnetic Charging Cable Type A

502271 USB Adapter 2.4A

0380 USB Car Charger

## iF3R

1x COB LED (Flood)

Five Light Levels

1000 / 750 / 500 / 250 / 100

1.5 / 2 / 3 / 5 / 15

-

-

Li-ion Battery 3.7V (internal)

14.8 / 4000

Yes

300

IP54

36 / 140 / 71

392 / 13.8

- **Small Floodlights** with outstanding Light Output
- **Flexible Attachment** and Alignment thanks to the Movable Stand, Magnet and Hook
- Easy Charging with the robust **Magnetic Charge System**
- **Cooling Technology** for long-term operation without overheating
- **Five Levels of Light**

502171 / 4058205020237

USB Power Supply, Magnetic Charging Cable

99.90

502265 Magnetic Charging Cable Type A

502271 USB Adapter 2.4A

0380 USB Car Charger

# iF2R



- 01 – Floodlight
- 02 – Spotlight
- 03 – Magnetic hook for fixing
- 04 – Battery and charging level indicator
- 05 – Magnetic Charge System





# iF4R music

 2500 lm<sup>1</sup>  
 15 h<sup>1</sup>





## Bluetooth®

- 01 – Built-in speaker with Bluetooth® control
- 02 – Five brightness settings
- 03 – Built-in magnet for easy attachment to metal surfaces (e.g. steel beams)
- 04 – Easy charging via **Magnetic Charge System**
- 05 – Large, tough handle for easy transport
- 06 – Multifunctional Switch - for quick and easy control of individual light functions



# iF8R

 4500 lm<sup>1</sup>  
 12 h<sup>1</sup>



## Bluetooth®

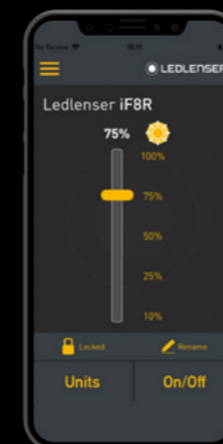

- 01 – Rechargeable
- 02 – **App-controlled:** with the app, up to four lamps can be remotely controlled
- 03 – **Powerbank function**
- 04 – **Built-in magnet** for easy attachment
- 05 – **Cooling Technology** – efficient cooling element for a long life and optimum performance
- 06 – **Five brightness levels**
- 07 – **Multifunctional Switch** - for quick and easy control of individual light functions
- 08 – Chip-on-board-Technology
- 09 – Easy to transport thanks to the large, robust handle













iF8R 





**LED**

-  LED-Configuration
-  Light Functions
-  Luminous Flux Flood<sup>1</sup> (lm)
-  Run Time Flood<sup>1</sup> (h)



**BATTERY AND CASE**

-  Battery
-  Battery Capacity<sup>2</sup> (Wh / mAh)
-  Rechargeable
-  Charging Time<sup>5</sup> (min)
-  IP Level

**SIZE AND WEIGHT**

-  B / H / T (mm)
-  Weight incl. Battery (g / oz)

**TECHNOLOGY**

-  Magnetic Charge System
-  Powerbank-Funktion
-  Cooling Technology
- More Features

**PACKAGING**

- Item no. Box / GTIN
- Contents Box

**Price (MSRP) in €**

**OPTIONAL ACCESSORIES**

# ULTRA BRIGHT WORK-SITE FLOODLIGHTS WITH POWERBANK FUNCTION OR MUSIC BOX



iF4R	iF4R music	iF8R
1x 34W COB LED	1x 34W COB LED	1x 66W COB LED
Five Light Levels	Five Light Levels	Five Light Levels
2500 / 1500 / 1000 / 500 / 200	2500 / 1500 / 1000 / 500 / 200	4500 / 3000 / 2000 / 1000 / 400
1,3 / 2 / 3 / 6 / 15	1,3 / 2 / 3 / 6 / 15	1,25 / 1,5 / 2,5 / 5 / 12
Li-ion Battery 3.7V (internal)	Li-ion Battery 3.7V (internal)	Li-ion Battery 3.7V (internal)
29.6 / 8000	29.6 / 8000	44.4 / 4000
Yes	Yes	Yes
240	360	240
IP54	IP54	IP54
•	•	•
•		•
Charge Indicator, Battery Indicator, Magnet, Standfuß	Charge Indicator, Battery Indicator, Transportation Lock, Bluetooth® <sup>8</sup> Speaker, Magnet, Magnetic Charge System	Charge Indicator, Battery Indicator, Bluetooth® <sup>8</sup> , Magnet, Standfuß
502001 / 4058205016209	502172 / 4058205020268	502002 / 4058205016230
USB Cable, USB Power Supply	USB Power Supply, Magnetic Charging Cable	Power Adapter
<b>149.00</b>	<b>199.00</b>	<b>209.00</b>
502271 USB Adapter 2.4A	502265 Magnetic Charging Cable Type A	
0380 USB Car Charger	502271 USB Adapter 2.4A	
	0380 USB Car Charger	





# — WORK & PROFESSIONAL INTRINSICALLY SAFE LIGHTS



FOR  
EXPLOSIVE  
WORKING  
AREA

Ex

 LEDLENSER





# FOR MAXIMUM SAFETY AT THE WORKPLACE

If you work in explosive environments, safety is extremely important when it comes to using electronics.

Ledlenser EX-series lights meet these standards in every aspect. Designed specifically for contact with explosive gases, vapors and dust in the best possible groups IIC and IIIC. They feature maximum dust protection, are protected from water and ATEX and IECEx approved.

Yet both lines - in compliance with the ATEX operating directives - are designed for different types of explosion hazards.

The **EX-series** is suitable for use in areas where explosive atmospheres are frequently present (zones 0, 1, 20 or 21).

## EXAMPLE FIELDS OF APPLICATION:

- Oil and gas drilling rig
- Gas, oil and coal-fired power plant
- Chemical park
- Storage site for oil and gas
- Petrol station and road tankers
- Sewerage and sewage treatment plant
- Paint shop and car repair shop
- Pharmaceutical factory
- Food factory
- Distillery
- Sawmill
- u.v.m.



\* Depending on the gases and/or dusts present.

## A glance at the ATEX Directive of the European Union

From oil and gas production facilities to chemical plants and distilleries as well as sawmills and bakeries: The so-called ATEX Directive applies to all businesses within the EU, in which explosive atmospheres can arise due to gas or dust. At the same time, the work areas are divided into zones according to the frequency and duration of the risk of explosion.

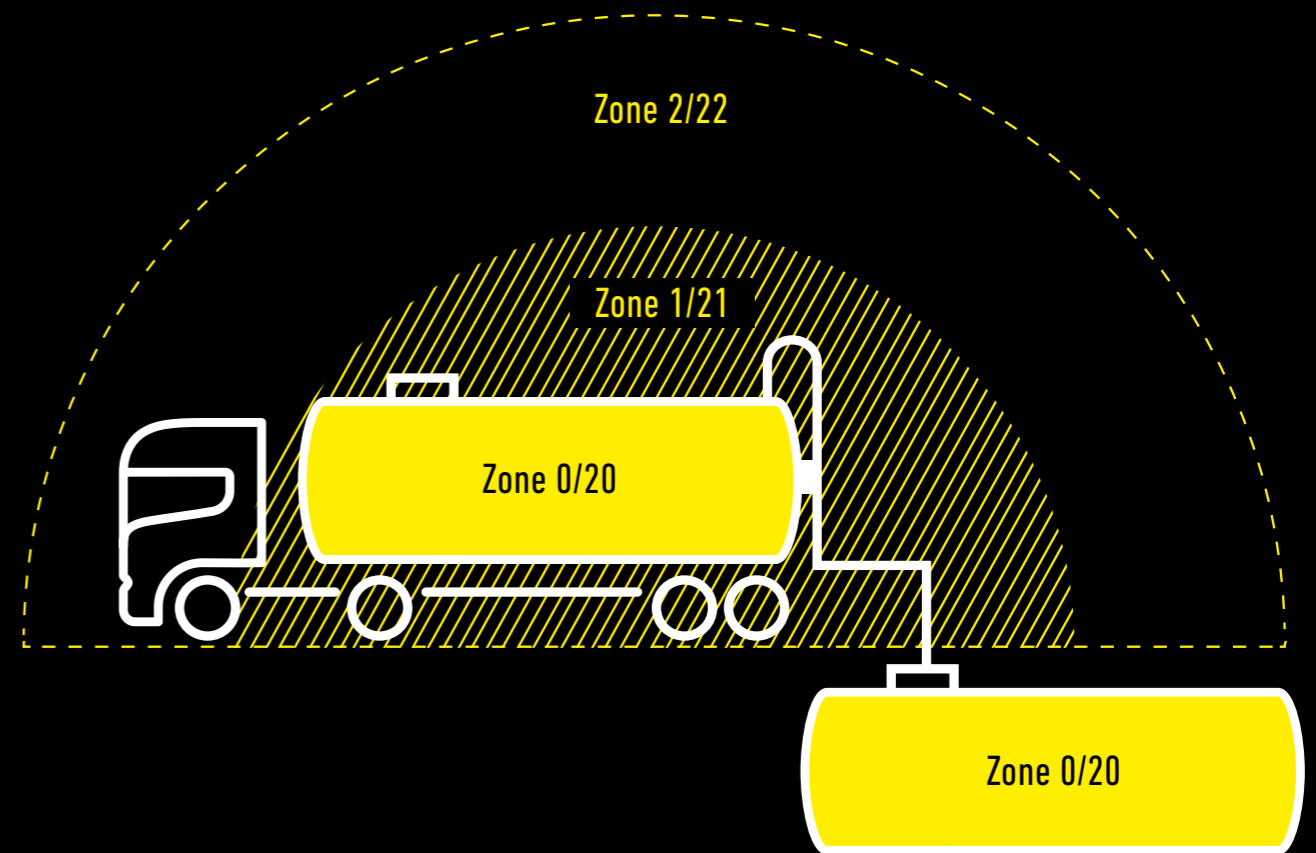

A place in which an explosive atmosphere consisting of a mixture with air of dangerous substances in the form of gas, vapor or a cloud of combustible dust is **continuously present** for long periods or frequently (e.g. in gas tanks or grain elevators).



Working areas in which explosive atmospheres in the form of flammable gases, vapors or dust clouds prevail **occasionally**.



Working areas in which explosive atmospheres in the form of flammable gases, vapors or dust clouds (e.g. in case of a gas leak) **usually do not prevail / prevail only for a short time**.







EX7R 

# THE TECHNOLOGICAL ADVANTAGE



 220 lm<sup>1</sup>  
 140 m<sup>1</sup>  
 45 h<sup>1</sup>

 **ADVANCED FOCUS SYSTEM**

- 01 – Suitable for the highest gas and dust groups (IIC/IIIC)
- 02 – **Magnetic Switch** for easy operation with gloves and protective equipment
- 03 – Dustproof and protected against powerful water jets (IP66 and IP68)
- 04 – **Advanced Focus System** – stepless focusing
- 05 – **Rechargeable** via charging station



<sup>1-8</sup> Information on page 176







	EX4	EX7
<b>LED</b>		
LED-Configuration	1x Power LED	1x Power LED
Light Functions	Power	Power / Low Power
Luminous Flux <sup>1</sup> (lm)	50	200 / 60
Beam Distance <sup>1</sup> (m)	35	120 / 70
Run Time <sup>1</sup> (h)	7	16 / 45
<b>BATTERY AND CASE</b>		
Battery	2x Micro (AAA) Alkaline 1.5V	3x Mignon (AA) Alkaline 1.5V
Battery Capacity <sup>2</sup>	-	-
Rechargeable	No	No
Charging Time <sup>5</sup> (min)	-	-
IP Level	IP66 and IP68	IP66 and IP68
<b>SIZE AND WEIGHT</b>		
Head Diameter (mm)	20	41
Länge (mm)	140	161
Weight incl. Battery (g / oz)	65 / 2.3	232 / 8.2
<b>TECHNOLOGY</b>		
Advanced Focus System		●
More Features	-	-
<b>ZERTIFIZIERUNG</b>		
EX-Zone	0/20	0/20
Gasgruppe	IIA, IIB, IIC	IIA, IIB, IIC
Staubgruppe	IIIA, IIIB, IIIC	IIIA, IIIB, IIIC
Temperaturklasse	T4/T <sub>200</sub> 135°C	T4/T <sub>200</sub> 135°C
<b>PACKAGING</b>		
Item no. Sleeve Box / GTIN	500682 / 4058205000437	500836 / 4058205001243
Contents Box	1 Set of Batteries	1 Set of Batteries, Belt Clip, Intelligent Clip
Price (MSRP) in €	<b>44.90</b>	<b>99.90</b>
<b>OPTIONAL ACCESSORIES</b>		

further accessories on page 110

	EX7R	EXH8	EXH8R
<b>LED</b>			
LED-Configuration	1x Power LED	1x Power LED	1x Power LED
Light Functions	Power / Low Power	Power / Low Power	Power / Low Power
Luminous Flux <sup>1</sup> (lm)	220 / 50	180 / 50	200 / 45
Beam Distance <sup>1</sup> (m)	140 / 65	120 / 65	130 / 60
Run Time <sup>1</sup> (h)	10 / 45	15 / 40	10 / 45
<b>BATTERY AND CASE</b>			
Battery	1x Li-ion Batterypack 3.7V	3x Mignon (AA) Alkaline 1.5V	1x Li-ion Batterypack 3.7V
Battery Capacity <sup>2</sup>	12 / 3250	-	12 / 3250
Rechargeable	Yes	No	Yes
Charging Time <sup>5</sup> (min)	660	-	660
IP Level	IP66 and IP68	IP66 and IP68	IP66 and IP68
<b>SIZE AND WEIGHT</b>			
Head Diameter (mm)	41	41	41
Länge (mm)	161		
Weight incl. Battery (g / oz)	228 / 8.0	345 / 12.2	342 / 12.1
<b>TECHNOLOGY</b>			
Advanced Focus System	●	●	●
More Features	Charge Indicator	Rear Light	Charge Indicator, Rear Light
<b>ZERTIFIZIERUNG</b>			
EX-Zone	1/21	0/20	1/21
Gasgruppe	IIA, IIB, IIC	IIA, IIB, IIC	IIA, IIB, IIC
Staubgruppe	IIIA, IIIB, IIIC	IIIA, IIIB, IIIC	IIIA, IIIB, IIIC
Temperaturklasse	T4/T135°C	T4/T <sub>200</sub> 135°C	T4/T135°C
<b>PACKAGING</b>			
Item no. Sleeve Box / GTIN	500837 / 4058205001274	501017 / 4058205007412	501018 / 4058205007443
Contents Box	1 Set of Batteries, Belt Clip, Intelligent Clip, Charging Station, Power Supply	1 Set of Batteries, Battery Cartridge	1 Set of Batteries, Charging Station, Power Supply
Price (MSRP) in €	<b>185.00</b>	<b>99.90</b>	<b>189.00</b>
<b>OPTIONAL ACCESSORIES</b>			
	502261 5 Station Charging Panel	501595 Silicone Headband Type	501595 Silicone Headband Type
	0386 Car Charger		502261 5 Station Charging Panel
			0386 Car Charger

<sup>1-8</sup> Information on page 176



WORK & PROFESSIONAL  
**ACCESSORIES**

# EX-FLASHLIGHTS

MODEL	EX7	EX7R	EX4	Item no.	MSRP (€)
Car Charger		●		0386	19.90
5 Station Charging Panel		●		502261	69.90

# EX-HEADLAMPS

MODEL	EXH8	EXH8R	Item no.	MSRP (€)
Car Charger		●	0386	19.90
5 Station Charging Panel		●	502261	69.90
Silicone Headband Type A	●	●	501595	9.90



Item no. 502261  
**5 Station Charging Panel**  
 Allows simultaneous charge up to five EX7Rs and EXH8R  
**€69.90 (MSRP)**



Item no. 501595  
**Silicone Headband Type A**  
 Excellent grip, durability and easy handling for the headlamps of the EX lamps of the EX series  
**€9.90 (MSRP)**





# — OUTDOOR & SPORTS FLASHLIGHTS



BUILT FOR ANY  
ADVENTURE

 LEDLENSER



# P7R SIGNATURE



## THE P-SERIES PREMIUM ILLUMINATION



516



☀️ 2000 lm<sup>1</sup>  
 ➡️ 330 m<sup>1</sup>  
 ⌚ 90 h<sup>1</sup>

- 01 – Powerful premium flashlight with **natural color rendering (80 CRI / 6500K)**
- 02 – **Mode Switch** for direct access to personalized light functions thanks to Smart Light Technology
- 03 – Additional **Red secondary light** on the side of the housing, e.g. to maintain the night vision in the dark
- 04 – **Hard-anodized housing material** for additional protection against wear and corrosion
- 05 – Extreme **dust and water protection (IP68)**
- 06 – **Flex Sealing Technology** – can be used for a short time underwater (including the focusing system) to a depth of one meter
- 07 – Personalize the light functions thanks to **Smart Light Technology**
- 08 – **Constant Light** – consistent level of brightness over time
- 09 – Integrated **battery and charge status display**



PRODUCT VIDEO

<sup>1</sup>\* Information on page 176





# MAXIMUM PERFORMANCE, STYLISH DESIGN



## P6R SIGNATURE

## P7R SIGNATURE

LED		
LED-Configuration	1x Xtreme LED, (1x red LED)	1x Xtreme LED, (1x red LED)
Light Functions	Boost / Power / Mid Power / Low Power (+ Position, Blink, S.O.S., Strobe, Red Light)	Boost / Power / Mid Power / Low Power (+ Position, Blink, S.O.S., Strobe, Red Light)
Luminous Flux <sup>1</sup> (lm)	1400 / 1100 / 450 / 15	2000 / 1200 / 500 / 15
Beam Distance <sup>1</sup> (m)	240 / 190 / 110 / 20	330 / 200 / 130 / 20
Run Time <sup>1</sup> (h)	- / 1.25 / 2.5 / 60	- / 2 / 3.25 / 90
Color Temperature (K)	6000 - 7500	6000 - 7500
Color Rendering Index (CRI)	80	80
BATTERY AND CASE		
Battery	1x 18650 Li-ion Battery 3.6V	1x 21700 Li-ion Battery 3.7V
Battery Capacity <sup>2</sup> (Wh / mAh)	10.89 / 3000	17.76 / 4800
IP Level	IP68	IP68
Rechargeable	Yes	Yes
Charging Time <sup>5</sup> (min)	225	270
Drop height (m)	2	2
SIZE AND WEIGHT		
Length – Defocused (mm)	151	158
Head Diameter (mm)	35	35
Weight incl. Battery (g / oz)	170 / 6.0	202 / 7.1
TECHNOLOGY		
Smart Light Technology	●	●
Flex Sealing Technology	●	●
Magnetic Charge System	●	●
Multi-Core Optics	●	●
Advanced Focus System	●	●
More Features	Red Alternate Light, Mode Switch, Emergency Light, Temperature Control, Dimmable, Transportation Lock, Flicker-free, Memory Function, Backup Mode, Emergency Light, Battery Indicator, Charge Indicator, Low Battery Warning	Red Alternate Light, Mode Switch, Emergency Light, Temperature Control, Dimmable, Transportation Lock, Flicker-free, Memory Function, Backup Mode, Emergency Light, Battery Indicator, Charge Indicator, Low Battery Warning
PACKAGING		
Item no. Box / GTIN	502189 / 4058205020756	502190 / 4058205020787
Contents Box	1 Set of Batteries, Leather Belt Pouch, Lanyard, Magnetic Charging Cable, Pocket Clip, USB Power Adapter, Wall Bracket	1 Set of Batteries, Leather Belt Pouch, Lanyard, Magnetic Charging Cable, Pocket Clip, USB Power Adapter, Wall Bracket
Price (MSRP) in €	<b>159.00</b>	<b>175.00</b>

Further accessories on page 118

THE P-SERIES CORE FROM PAGE 26

THE P-SERIES WORK FROM PAGE 60



## P18R SIGNATURE

LED	3x Xtreme LED
Light Functions	Boost / Power / Mid Power / Low Power (+ Position, Blink, S.O.S., Strobe)
Luminous Flux <sup>1</sup> (lm)	4500 / 2600 / 1000 / 30
Beam Distance <sup>1</sup> (m)	720 / 420 / 260 / 50
Run Time <sup>1</sup> (h)	- / 2.5 / 4.5 / 70
Color Temperature (K)	6000 - 7200
Color Rendering Index (CRI)	70
Battery	1x Li-ion Battery pack 11.1V
Battery Capacity <sup>2</sup> (Wh / mAh)	33.3 / 3000
IP Level	IP54
Rechargeable	Yes
Charging Time <sup>5</sup> (min)	330
Drop height (m)	1
Length – Defocused (mm)	171
Head Diameter (mm)	86
Weight incl. Battery (g / oz)	637 / 22.5
Smart Light Technology	●
Flex Sealing Technology	●
Magnetic Charge System	●
Multi-Core Optics	●
Advanced Focus System	●
More Features	X-Lens Technology, Rapid Focus, Dimmable, Transportation Lock, Flicker-free, Memory Function, Backup Mode, Emergency Light, Battery Indicator, Charge Indicator, Low Battery Warning
Item no. Box / GTIN	502191 / 4058205020817
Contents Box	1 Set of Batteries, Lanyard, USB Power Adapter, Magnetic Charging Cable
Price (MSRP) in €	<b>269.00</b>

<sup>1-8</sup> Information on page 176

ALL ABOUT CORE-WORK-SIGNATURE FROM PAGE 6

# P-SERIES SIGNATURE





# ACCESSORIES

## FLASHLIGHTS

### P-SERIES SIGNATURE

#### LEDLENSER CONNECTING SYSTEM

MODEL	P6R SIGNATURE	P7R SIGNATURE	Item no.	MSRP (€)
Lamp Adapter Type C	•		502250	4.90
Lamp Adapter Type D		•	502251	4.90
Adapter suitable for GoPro** Type D	•	•	502246	7.90
Adapter suitable for Tripod Type D	•	•	502247	9.90
Belt Clip Type A	•	•	502253	6.90
Helmet Mount for Euroslot Type A	•	•	502254	6.90
Flexible Mount Type A	•	•	502255	14.90
Universal Mounting Bracket Type E	•	•	502256	12.90



Item no. 502511  
**Powerbank Flex5**  
More information on page 152  
€39.90 (MSRP)



Item no. 502127  
**Powerbank Flex10**  
More information on page 152  
€69.90 (MSRP)



Diverse Item no.  
**Charging Station**  
professional charging station  
Including magnetic charging cable,  
compatible with 5 Station Charging  
Panel  
€12.90 (MSRP)



Item no. 502261  
**5 Station Charging Panel**  
Charge up to five  
compatible Ledlenser  
Lights (requirement: suitable  
charging station)  
€69.90 (MSRP)

#### ACCESSORIES POWER SUPPLY

MODEL	P6R SIGNATURE	P7R SIGNATURE	P18R SIGNATURE	Item no.	MSRP (€)
Powerbank Flex3	•			502126	34.90
Powerbank Flex5		•		502511	39.90
Powerbank Flex7	•			502125	54.90
Powerbank Flex10		•		502127	69.90
Magnetic Charging Cable Type A	•	•	•	502265	6.90
Wall Mount Type A (magnetic charge cable included)	•			502257	9.90
Wall Mount Type B (magnetic charge cable included)		•		502258	9.90
Charging Station Type B (magnetic charge cable included)	•	•		502260	12.90
5 Station Charging Panel	•	•		502261	69.90
USB Adapter 2.4A	•	•	•	502271	14.90
USB Car Charger	•	•	•	0380	9.90
21700 Li-ion rechargeable battery 4800mAh		•		502262	24.90
18650 Li-ion rechargeable Battery 3000 mAh	•			501001	24.90
Li-ion direct USB rechargeable Battery 2500 mAh	•			502595	24.90

#### Lamp Adapter Type A-D

##### Mounting adapter (Requirement)

The adapter enables the connection between flashlights and the versatile Ledlenser connecting system. Now the light is compatible with various additional accessory brackets and mounts.



Diverse Item no.  
€4.90 (MSRP)



Item no. 502246  
**Adapter suitable for GoPro\*\***  
Compatible with almost all GoPro\*\* systems and accessories  
€7.90 (MSRP)

Item no. 502255  
**Flexible Mount**  
Flexible fastening system with magnet, adhesive pad and hole to screw on  
€14.90 (MSRP)



Item no. 502254  
**Helmet Mount for Euroslot**  
Hard hat mount for 30 mm Euroslot €6.90 (MSRP)



Item no. 502256  
**Universal Mounting Bracket**  
Stable universal fastening to cylindrical objects €12.90 (MSRP)



Item no. 502247  
**Tripod Adapter**  
Tripod adapter  
€9.90 (MSRP)

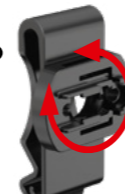

Item no. 502253  
**Belt Clip Type A**  
Belt clip for lights and battery packs €6.90 (MSRP)

\* This product is not affiliated with GoPro Inc. or its products and services. services. GoPro is a registered trademark of GoPro, Inc.



# ACCESSORIES

## FLASHLIGHTS

### P-SERIES SIGNATURE

#### POUCHES / FILTERS / MOUNTS AND MORE

MODEL	P6R SIGNATURE	P7R SIGNATURE	P18R SIGNATURE	Item no.	MSRP (€)
Color Filter Set 35.1mm	•	•		502238	19.90
Signal Cone 35.1mm	•	•		502237	9.90
Signal Cone White 35.1mm	•	•		502243	9.90
Roll Protection 85.5mm			•	502242	14.90
Case Type A	•	•		502263	24.90
Case Type B	•	•		502264	29.90
Pouch Type G	•	•		0342	9.90
Leather Pouch Type D	•	•		502269	19.90
Universal Mounting System	•	•		0362	14.90



Item no. 0362  
**Universal Mounting System**  
 This universal mounting fixes flashlights with a diameter of 25-34 mm securely to tripods, rods and tubes in next to no time. The light and fixation are aligned in parallel  
**€14.90 (MSRP)**



Item no. 502269  
**Leather Pouch**  
 leather pouch  
**€19.90 (MSRP)**



Item no. 502263  
**Case Type A**  
**Soft case transport bag:** Inside there are elastic loops and a mesh pocket to attach the light, Powerbank, cables and other accessories. On the outside, a practical handle and loops for attachment to a belt or backpack ensure optimal portability.  
 (Size 200mm x 135mm x 72mm)  
**€24.90 (MSRP)**



Item no. 502238  
**Color Filter Sets**  
 Color filter set  
**€19.90 (MSRP)**





# — OUTDOOR & SPORTS HEADLAMPS



 LEDLENSER





# H19R SIGNATURE



# THE FLAGSHIP OF THE SIGNATURE RANGE

☀️ 4000 lm<sup>1</sup>  
 📡 330 m<sup>1</sup>  
 ⌚ 20 h<sup>1</sup>

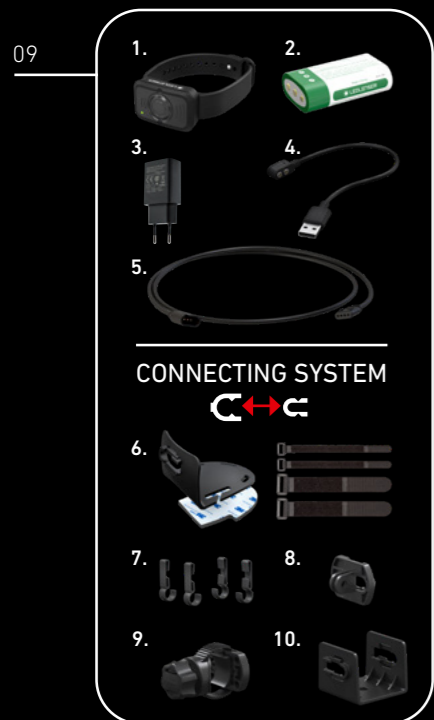
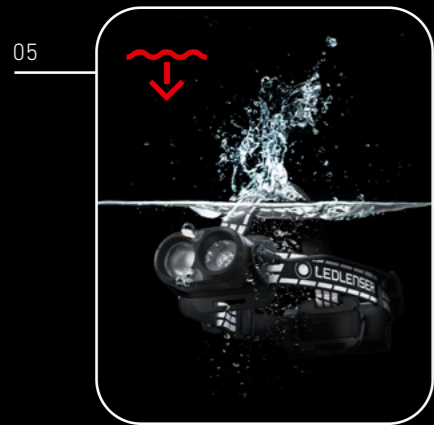

- 01 – Fusion Beam** – individually adjustable flood and spotlight for a unique light image with perfect illumination
- 02 – Multi-Core Optics** – homogeneous light image through special faceting of the lens
- 03 – Ledlenser Connect App and Bluetooth® remote control** enable personalization and remote control of the light functions
- 04 – Optisense Technology** – automatic adaptation to the light conditions thanks to the integrated sensor
- 05 – Extreme Dust and Water Protection (IP68)**
- 06 – Additional Red Light** to maintain night vision
- 07 – Stepless Swivel Mechanism** for vertical alignment of the light cone
- 08 – Ledlenser Connecting System** – an interface for many accessory parts (see page 22)
- 09 – Additional Content:** 1. Bluetooth® remote control, 2. battery, 3. USB power adapter, 4. Magnetic charging cable, 5. Extension cable 6. Helmet connecting kit, 7. Helmet clips, 8. GoPro Adapter, 9. Universal holder, 10. Stand holder ▶ Supplied in a soft case
- 10 – Reflective Headband**

Bluetooth®



<sup>1-8</sup> Information on page 176





# H-SERIES SIGNATURE



THE ULTIMATE LIGHTING  
FOR THE HIGHEST  
DEMANDS



H7R SIGNATURE



H19R SIGNATURE



LED		
☰ LED-Configuration	1x Xtreme LED	1x Xtreme LED
🔊 Light Functions	Boost / Power / Low Power (+ Strobe, Positon, SOS und Blink)	Boost / Power / Mid Power / Low Power (+ Strobe, Positon, SOS und Blink)
☀️ Luminous Flux <sup>1</sup> (lm)	1200 / 700 / 15	4000 / 1800 / 800 / 200
📏 Beam Distance <sup>1</sup> (m)	260 / 220 / 25	330 / 250 / 150 / 80
🕒 Run Time <sup>1</sup> (h)	- / 3.5 / 65	- / 3.5 / 7 / 20
🌡️ Color Temperature (K)	6500	6500
📐 Color Rendering Index (CRI)	80	80
BATTERY AND CASE		
🔋 Battery	1x 21700 Li-ion Akku 3.7V	1x Li-ion Akkupack 7.4V
🔋 Battery Capacity <sup>2</sup> (Wh / mAh)	17.76 / 4800	35.52 / 4800
☁️ IP Level	IP67	IP68
🔌 Rechargeable	Yes	Yes
🕒 Charging Time <sup>5</sup> (min)	210	330
⬇️ Drop height (m)	1.5	1.5
SIZE AND WEIGHT		
📏 Head Diameter (mm)	41	68
⚖️ Weight incl. Battery (g / oz)	259 / 9.1	374 / 13.2
TECHNOLOGY		
🔴 Fusion Beam		●
⚙️ Flex Sealing Technology	●	
🔌 Magnetic Charge System	●	●
🌡️ Temperature Control	●	●
🔌 Advanced Focus System	●	
More Features	Cooling Technology, Emergency Light, Bluetooth <sup>®</sup> , Dimmable, Transportation Lock, Flicker-free, Memory Mode, Backup Mode, Battery Indicator, Charge Indicator, Low Battery Warning, Constant Light	Mutli-Core Optics, Red Light, Optisense, Cooling Technology, Emergency Light, Bluetooth <sup>®</sup> , Dimmable, Transportation Lock, Flicker-free, Memory Mode, Backup Mode, Battery Indicator, Charge Indicator, Low Battery Warning, Constant Light
PACKAGING		
Item no. Box / GTIN	502197 / 4058205021081	502198 / 4058205021111
Contents Soft Case	1 Set of Batteries, Helmet Clips, Adapter for GoPro, Helmet Holder, Hook-and-Loop straps, Adhesive Pads, Magnetic Charging Cable, Tripod Holder, USB Power Adapter, Universal Holder, Extension Cable	Bluetooth <sup>®</sup> remote control, 1 Set of Batteries, Helmet Clips, Adapter for GoPro, Helmet Holder, Hook-and-Loop straps, Adhesive Pads, Magnetic Charging Cable, Tripod Holder, USB Power Adapter, Universal Holder, Extension Cable, Adhesive Pads
Price (MSRP) in €	169.00	339.00

Accessories on page 128

<sup>1-8</sup> Information on page 178

THE H-SERIES CORE FROM PAGE 46

THE H-SERIES WORK FROM PAGE 74





# ACCESSORIES

## HEADLAMPS

### H-SERIES SIGNATURE

#### LEDLENSER CONNECTING SYSTEM

MODEL	H7R SIGNATURE	H19R SIGNATURE	Item no.	MSRP (€)
Adapter suitable for GoPro** Type D	•	•	502246	7.90
Adapter suitable for Tripod Type D	•	•	502247	9.90
Belt Clip Type A	•	•	502253	6.90
Helmet Connecting Kit Type H	•	•	502314	14.90
Universal Mounting Bracket Type E	•	•	502256	12.90

Thanks to the integrated slide the light is immediately compatible with various additional brackets



Item no. 502246  
**Adapter suitable for GoPro\*\***  
Compatible with almost all GoPro\*\* systems and accessories  
**€7.90 (MSRP)**

Item no. 502253  
**Belt Clip Type A**  
Belt clip for lights and batteries  
**€6.90 (MSRP)**

Item no. 502314  
**Helmet Connecting Kit H**  
Stable helmet holder system for a wide variety of helmet models  
**€14.90 (MSRP)**

Item no. 502256  
**Universal Mounting Bracket**  
Stable universal fastening for rods  
**€12.90 (MSRP)**

Item no. 502247  
**Adapter suitable for Tripod**  
**€9.90 (MSRP)**



Item no. 502311  
**Wireless Remote Control Type A**  
Ledlenser meets Bluetooth®: With this handy remote control, compatible Ledlenser lights with Bluetooth® function can be controlled remotely at the touch of a button. The remote control is linked to the headlamp via the Ledlenser Connect app and can then e.g. can be worn on the wrist, handlebars or ski / hiking poles to have the perfect light within easy reach  
**€34.90 (MSRP)**



Item no. 502411  
**Bluetooth® 2x 21700 Batterybox**  
Upgrade to smart control: Bluetooth® Li-ion battery box for use with the Ledlenser Connect app or with the available remote control  
**€59.90 (MSRP)**

Item no. 502312  
**Extension Cable**  
Practical extension cable (120 cm) that is plugged in between the lamp head and the battery box - so the battery can easily be stowed in the backpack  
**€9.90 (MSRP)**



Item no. 502265  
**Magnetic Charging Cable**  
Magnetic charging cable with standard USB-A connector  
**€6.90 (MSRP)**

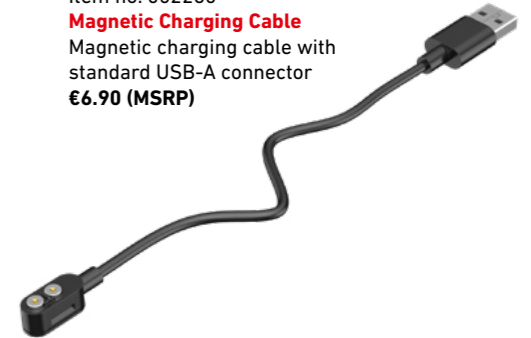

#### ACCESSORIES POWER SUPPLY / COLOR FILTERS AND MORE

MODEL	H7R SIGNATURE	H19R SIGNATURE	Item no.	MSRP (€)
Powerbank Flex5	•		502511	39.90
Powerbank Flex10	•		502127	69.90
Wireless Remote Control Type A	•	•	502311	34.90
Color Filter Set 40mm	•		502308	18.90
Helmet Band Fixing Clips Type A	•		502313	4.90
Transparent Silicone Headband Type A	•	•	502451	9.90
Headband mit Overheadband CORE	•	•	502469	9.90
Headband mit Overheadband WORK	•	•	502470	9.90
Headband mit Overheadband SIGNATURE	•	•	502471	12.90
Magnetic Charging Cable Type A	•	•	502265	6.90
Extension Cable Type C	•	•	502312	9.90
USB Adapter 2.4A	•	•	502271	14.90
21700 Li-ion Rechargeable Battery 4800mAh	•		502262	24.90
2x 21700 Li-ion Rechargeable Battery Pack		•	502310	39.90
Bluetooth® 21700 Batterybox	•		502410	49.90
Bluetooth® 2x 21700 Batterybox	•	•	502411	59.90

\* This product is not affiliated with GoPro Inc. or its products and services. services. GoPro is a registered trademark of GoPro, Inc.



MH11 



 1000 lm<sup>1</sup>  
 320 m<sup>1</sup>  
 100 h<sup>1</sup>



- 01 – **Ledlenser Connect App** offers direct control and programmable light functions
- 02 – **Optisense Technology** automatically adjusts to surrounding light conditions
- 03 – **Advanced Focus System** – stepless focusing
- 04 – **Multicolor LED** in red, green and blue for use at night, hunting and fishing
- 05 – Smooth **Swivel Mechanism** allows for a click-less light tilt in an upward or downward motion
- 06 – **Innovatives Mounting System** enables quick detachment of the lamp head from the band to use as a handheld light
- 07 – **Magnetic Charging System** for fast and easy battery charging

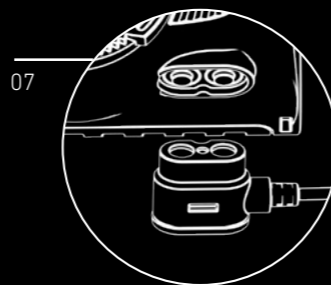
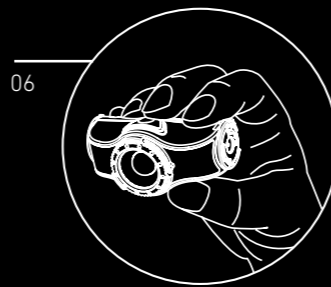

<sup>1-8</sup> Information on page 176

# INTELLIGENT HEADLAMP FOR ADVENTURERS



Video: Ledlenser Connect App





# MH-SERIES



MH3

MH4

LED		
LED-Configuration	1x High Power LED	1x High Power LED, 1x Red LED
Light Functions	Power / Low Power	Power / Low Power
Luminous Flux <sup>1</sup> (lm)	200 / 20	400 / 20
Beam Distance <sup>1</sup> (m)	130 / 40	180 / 40
Run Time <sup>1</sup> (h)	4.5 / 35	4 / 35
BATTERY AND CASE		
Battery	1x Mignon (AA) Alkaline 1.5V	1x 14500 Li-ion Battery 3.7V
Battery Capacity <sup>2</sup> (Wh / mAh)	–	2.77 / 750
Rechargeable	No	Yes
Charging Time <sup>5</sup> (min)	–	150
IP Level	IP54	IP54
SIZE AND WEIGHT		
Head Diameter (mm)	31	31
Weight incl. Battery (g / oz)	92 / 3.2	94 / 3.3
TECHNOLOGY		
Smart Light Technology	●	●
Rapid Focus	●	●
Dual Power Source	●	●
Advanced Focus System	●	●
Magnetic Charge System		●
More Features	Low Battery Warning	Low Battery Warning, Battery Indicator, Charge Indicator, Red Light
PACKAGING		
Item no. Window Box / GTIN	501597 <b>Black</b> / 4058205014656	502151 <b>Black</b> / 4058205020121
Contents Box	1 Set of Batteries	1 Set of Batteries, Magnetic Charging Cable
Price (MSRP) in €	<b>34.90</b>	<b>59.90</b>
OPTIONAL ACCESSORIES		
	502220 Helmet Connecting Kit Type D	502093 Powercase (on page 141)
	500986 Charging station	502220 Helmet Connecting Kit Type D
further accessories on page 140	500985 14500 Li-ion rech. Battery	0380 USB Car Charger



MH5

LED-Configuration	1x High Power LED, 1x Red LED
Light Functions	Power / Low Power
Luminous Flux <sup>1</sup> (lm)	400 / 20
Beam Distance <sup>1</sup> (m)	180 / 40
Run Time <sup>1</sup> (h)	4 / 35
BATTERY AND CASE	
Battery	1x 14500 Li-ion Battery 3.7V
Battery Capacity <sup>2</sup> (Wh / mAh)	2.77 / 750
Rechargeable	Yes
Charging Time <sup>5</sup> (min)	150
IP Level	IP54
SIZE AND WEIGHT	
Head Diameter (mm)	31
Weight incl. Battery (g / oz)	94 / 3.3
TECHNOLOGY	
Smart Light Technology	●
Rapid Focus	●
Dual Power Source	●
Advanced Focus System	●
Magnetic Charge System	●
More Features	Low Battery Warning, Battery Indicator, Charge Indicator, Red Light
PACKAGING	
Item no. Window Box / GTIN	502147 <b>Black</b> / 4058205019873
Contents Box	1 Set of Batteries, Magnetic Charging Cable
Price (MSRP) in €	<b>52.90</b>
OPTIONAL ACCESSORIES	
	502093 Powercase (on page 141)
	502220 Helmet Connecting Kit Type D
	0380 USB Car Charger

# MH5 <sup>rechargeable</sup>

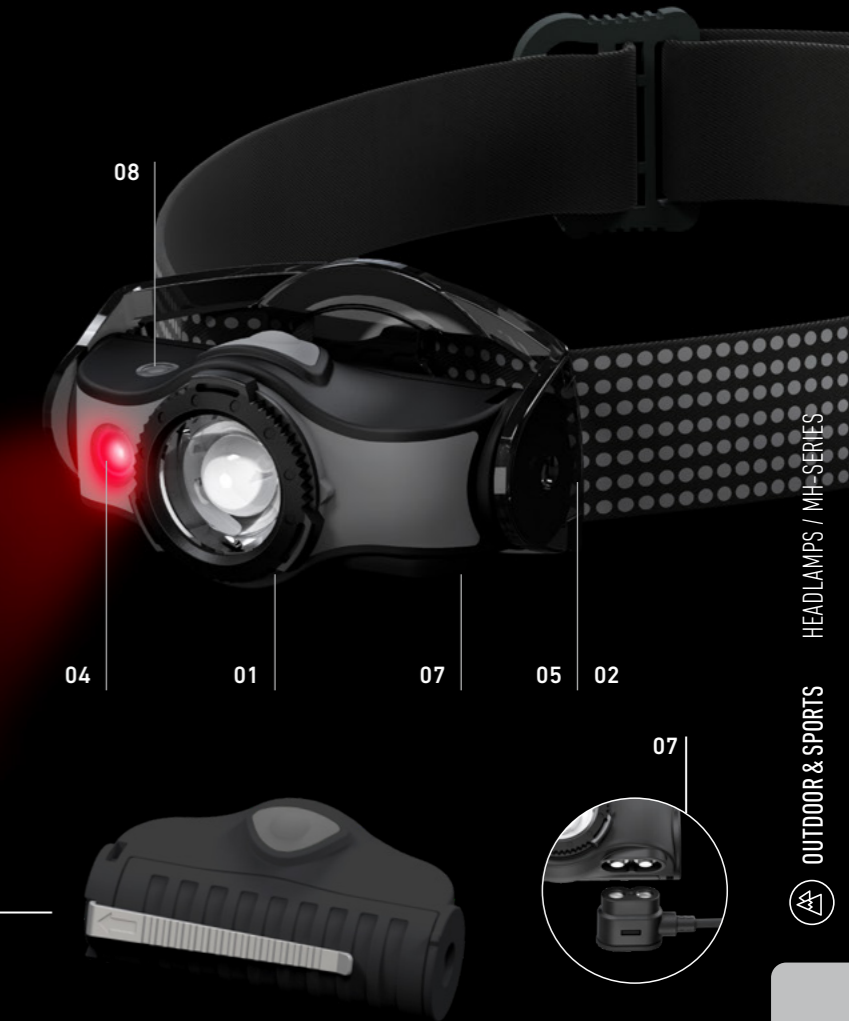

- 01 – Advanced Focus System** – stepless focusing
- 02 – Innovatives Mounting System** enables easy to remove and put on lamp head and battery
- 03 – Numerous attachment options** using metal clips on the lamp head
- 04 – Red Light Function** to maintain the night vision ability
- 05** – Variable **swivel mechanism** for aiming the light cone
- 06 – Dual Power Source** – rechargeable or primary battery, this technology allows for both
- 07** – Convenient and safe charging of the batteries thanks to **Magnetic Charge System**
- 08 – Battery Indicator** and **Charge Indicator**





# MH-SERIES



	MH7	MH8
<b>LED</b>		
LED-Configuration	1x Xtreme LED, 1x Red LED	1x Xtreme LED, 1x Multicolor LED
Light Functions	Boost / Power / Mid Power / Low Power (+ Blink)	Boost / Power / Mid Power / Low Power (+ Blink)
Luminous Flux <sup>1</sup> (lm)	600 / 400 / 170 / 20	600 / 400 / 170 / 20
Beam Distance <sup>1</sup> (m)	200 / 180 / 120 / 40	200 / 180 / 120 / 40
Run Time <sup>1</sup> (h)	- / 7 / 10 / 60	- / 7 / 10 / 60
<b>BATTERY AND CASE</b>		
Battery	1x Li-ion Akkupack 3.7V	1x Li-ion Akkupack 3.7V
Battery Capacity <sup>2</sup>	5.73 / 1550	5.73 / 1550
Rechargeable	Yes	Yes
Charging Time <sup>5</sup> (min)	270	270
IP Level	IP54	IP54
<b>SIZE AND WEIGHT</b>		
Head Diameter (mm)	31	31
Weight incl. Battery (g / oz)	139 / 4.9	139 / 4.9
<b>TECHNOLOGY</b>		
Smart Light Technology	●	●
Rapid Focus	●	●
Dual Power Source	●	●
Advanced Focus System	●	●
Magnetic Charge System	●	●
Optisense Technology		
More Features	Cooling Technology, Energy Saving, Constant Light, Low Battery Warning, Charge Indicator, Battery Indicator, Red Light, Transportation Lock	Cooling Technology, Energy Saving, Constant Light, Low Battery Warning, Charge Indicator, Battery Indicator, Red Light, Green Light, Blue Light, Transportation Lock
<b>PACKAGING</b>		
Item no. Window Box / GTIN	501599 <b>Gray</b> / 4058205014700	502156 <b>Black</b> / 4058205019996
Contents Box	1 Set of Batteries, Magnetic Charging Cable	1 Set of Batteries, Magnetic Charging Cable
Price (MSRP) in €	<b>79.90</b>	<b>84.90</b>

	MH10	MH11
<b>LED</b>		
LED-Configuration	1x Xtreme LED	1x Xtreme LED, 1x Multicolor LED
Light Functions	Power / Mid Power / Low Power	Boost / Power / Mid Power / Low Power (+ Blink, S.O.S., Strobe)
Luminous Flux <sup>1</sup> (lm)	600 / 250 / 10	1000 / 750 / 300 / 10
Beam Distance <sup>1</sup> (m)	150 / 100 / 20	320 / 300 / 200 / 30
Run Time <sup>1</sup> (h)	10 / 15 / 120	- / 4 / 8 / 100
<b>BATTERY AND CASE</b>		
Battery	1x 18650 Li-ion Akku 3.6V	1x 18650 Li-ion Akku 3.6V
Battery Capacity <sup>2</sup>	11.52 / 3200	11.52 / 3200
Rechargeable	Yes	Yes
Charging Time <sup>5</sup> (min)	360	420
IP Level	IP54	IP54
<b>SIZE AND WEIGHT</b>		
Head Diameter (mm)	36	40
Weight incl. Battery (g / oz)	158 / 5.6	179 / 6.3
<b>TECHNOLOGY</b>		
Smart Light Technology	●	●
Rapid Focus	●	●
Dual Power Source		
Advanced Focus System	●	●
Magnetic Charge System		●
Optisense Technology		●
More Features	Temperature Control System, Energy Saving, Constant Light, Low Battery Warning, Charge Indicator, Rear Light, Transportation Lock	Cooling Technology, Energy Saving, Constant Light, Low Battery Warning, Charge Indicator, Battery Indicator, Red Light, Green Light, Blue Light, Transportation Lock, Bluetooth®, Dimmable, Memory Mode, Temperature Control System
<b>PACKAGING</b>		
Item no. Window Box / GTIN	501513 / 4058205014533	500996 <b>Gray</b> / 4058205013833
Contents Box	1 Set of Batteries, USB Charging Cable, Belt Pouch, Filter Set	1 Set of Batteries, Magnetic Charging Cable, Belt Pouch
Price (MSRP) in €	<b>99.90</b>	<b>179.00</b>

LIGHT  
ENGINEERED  
FOR  
BETTER  
ADVENTURES

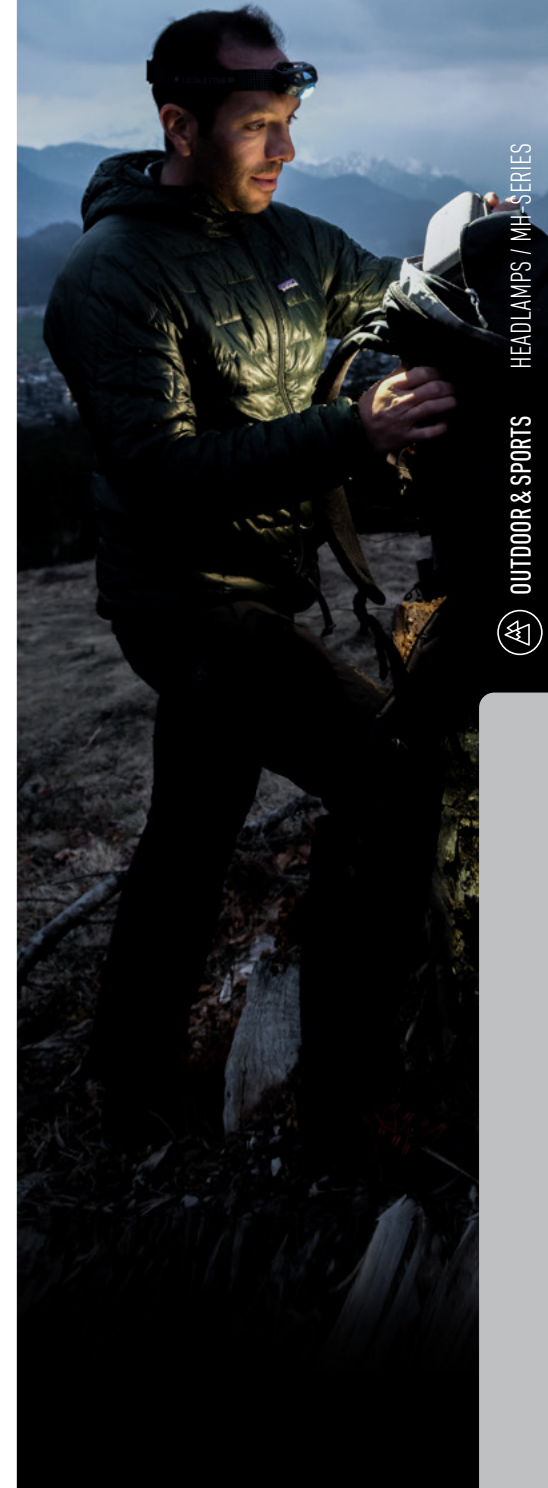

HEADLAMPS / MH-SERIES  
OUTDOOR & SPORTS

Further accessories on page 140

<sup>1-8</sup> Information on page 176







# NEO-SERIES

## LIGHTER, SMALLER, FASTER

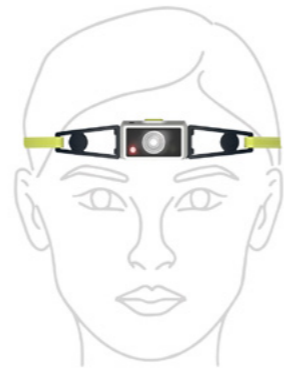
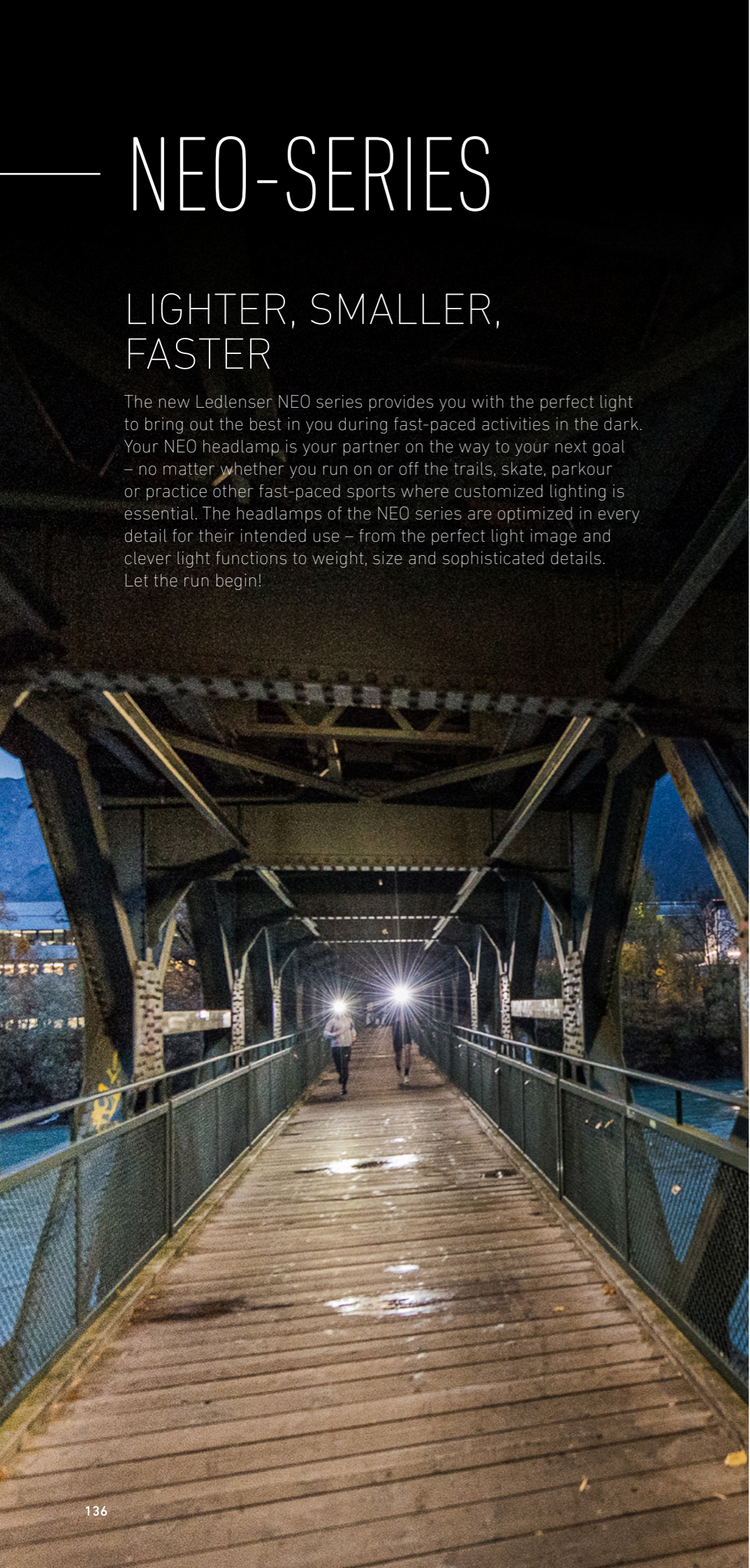
The new Ledlenser NEO series provides you with the perfect light to bring out the best in you during fast-paced activities in the dark. Your NEO headlamp is your partner on the way to your next goal – no matter whether you run on or off the trails, skate, parkour or practice other fast-paced sports where customized lighting is essential. The headlamps of the NEO series are optimized in every detail for their intended use – from the perfect light image and clever light functions to weight, size and sophisticated details. Let the run begin!



**NEO1R**   
 ☀ 250 lm<sup>1</sup>  
 ⌚ 15 h<sup>1</sup>  
 ⚖ 39 g



### ULTRALIGHT AND VERSATILE



Additional red light as a signal light and to maintain night vision capability



Quick and easy battery charging via Magnetic Charge System with status LED



Tilting lamp head for individual adjustment of the light cone



**NEO3**  
 ☀ 400 lm<sup>1</sup>  
 ⌚ 20 h<sup>1</sup>  
 ⚖ 97 g



### BRIGHT ALLROUNDER FOR SPORTY MISSIONS



Perfect light pattern for fast-moving activities with combined close and long distance light

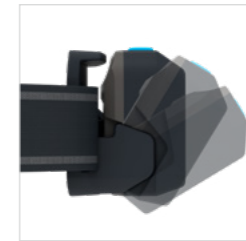

Tilting lamp head for individual adjustment of the light cone



Minimalist, ergonomic design with cable tunnel for perfect fit and wearing; 360° visibility thanks to red flashing rear light; easy operation with three AAA batteries



**NEO5R**   
 ☀ 600 lm<sup>1</sup>  
 ⌚ 35 h<sup>1</sup>  
 ⚖ 104 g



### COMPACT POWER FOR AMBITIOUS ATHLETES



Perfect light pattern for fast-moving activities with combined close and long distance light



360° visibility thanks to red flashing rear light and reflective headband; quick and easy battery charging via Magnetic Charge System with status LED



Tilting lamp head for individual adjustment of the light cone



**NEO9R**   
 ☀ 1200 lm<sup>1</sup>  
 ⌚ 120 h<sup>1</sup>  
 ⚖ 199 g



### THE PERFECT LIGHT FOR TRAIL RUNNERS



Extremely powerful trail running headlamp with outstanding light image; multiple light sources perfectly illuminate near and far in every situation



Extremely powerful, replaceable battery pack; rechargeable via Magnetic Charge System with status LED



Ergonomic design with removable overhead strap for perfect fit and wearing comfort during outdoor activities; included chest belt as additional attachment option



# NEO-SERIE



**NEO1R**

LED	
LED-Configuration	1x High Power LED
Light Functions	Boost / Power / Low Power
Luminous Flux <sup>1</sup> (lm)	250 / 150 / 20
Beam Distance <sup>1</sup> (m)	80 / 50 / 15
Run Time <sup>1</sup> (h)	- / 3 / 15
BATTERY AND CASE	
Battery	1x Li-ion Battery pack 3.7 V
Battery Capacity <sup>2</sup> (Wh / mAh)	2.7 / 730
Rechargeable	Yes
Charging Time <sup>5</sup> (min)	180
IP Level	IP67
SIZE AND WEIGHT	
Head Diameter (mm)	48
Weight incl. Battery (g / oz)	39 / 1.4
TECHNOLOGY	
Fusion Beam	
Magnetic Charge System	●
Temperature Control	●
More Features	Low Battery Warning, Battery Indicator, Charge Indicator, Red Light, Transportation Lock, Backup Mode
PACKAGING	
Item no. Box / GTIN	502713 <b>Blue</b> / 4058205029971
Item no. Box / GTIN	502720 <b>White/Green</b> / 4058205030168
Item no. Box / GTIN	502712 <b>Black</b> / 4058205029957
Contents Box	Magnetic Charging Cable,
<b>Price (MSRP) in €</b>	<b>46.90</b>
OPTIONAL ACCESSORIES	
further accessories on page 148	0332 Pouch Type H



**NEO3**

**NEO5R**

**NEO9R**

LED		LED		LED	
LED-Configuration	2x High Power LED	2x High Power LED	3x Xtreme LED		
Light Functions	Boost / Power / Mid Power / Low Power	Boost / Power / Mid Power / Low Power	Boost / Power / Mid Power / Low Power		
Luminous Flux <sup>1</sup> (lm)	400 / 200 / 100 / 20	600 / 300 / 100 / 20	1200 / 600 / 200 / 20		
Beam Distance <sup>1</sup> (m)	80 / 60 / 40 / 5	100 / 70 / 40 / 5	200 / 120 / 60 / 5		
Run Time <sup>1</sup> (h)	- / 3 / 6 / 20	- / 4 / 8 / 35	- / 5 / 12 / 120		
BATTERY AND CASE		BATTERY AND CASE		BATTERY AND CASE	
Battery	3x Micro (AAA) Alkaline 1.5V	1x Li-ion Battery pack 3.7 V	2x 18650 Li-ion Battery pack. 3.7V		
Battery Capacity <sup>2</sup> (Wh / mAh)	-	6.66 / 1800	18.5 / 5000		
Rechargeable	No	Yes	Yes		
Charging Time <sup>5</sup> (min)	-	240	330		
IP Level	IP54	IP54	IP54		
SIZE AND WEIGHT		SIZE AND WEIGHT		SIZE AND WEIGHT	
Head Diameter (mm)	41	41	57		
Weight incl. Battery (g / oz)	97 / 3.4	106 / 3.7	199 / 7.0		
TECHNOLOGY		TECHNOLOGY		TECHNOLOGY	
Fusion Beam	●	●	●		
Magnetic Charge System		●	●		
Temperature Control	●	●	●		
More Features	Low Battery Warning, Battery Indicator, Rear Light, Transportation Lock, Backup Mode	Low Battery Warning, Battery Indicator, Charge Indicator, Rear Light, Transportation Lock, Backup Mode	Low Battery Warning, Battery Indicator, Charge Indicator, Rear Light, Transportation Lock, Backup Mode		
PACKAGING		PACKAGING		PACKAGING	
Item no. Box / GTIN	502718 <b>Blue</b> / 4058205030106	502716 <b>Blue</b> / 4058205030052	502715 <b>Blue</b> / 4058205030021		
Item no. Box / GTIN	502719 <b>White</b> / 4058205030137	502757 <b>White</b> / 4058205030885	502324 <b>Black</b> / 4058205024167		
Item no. Box / GTIN	502717 <b>Black</b> / 4058205030083	502323 <b>Black</b> / 4058205024136			
Contents Box	1 Set of Batteries, Comfort Pad	1 Battery Pack, Magnetic Charging Cable, Comfort Pad, Chest Strap	1 Battery Pack, Magnetic Charging Cable, Comfort Pad, Overhead Strap, Chest Strap		
<b>Price (MSRP) in €</b>	<b>36.90</b>	<b>62.90</b>	<b>115.00</b>		
OPTIONAL ACCESSORIES		OPTIONAL ACCESSORIES		OPTIONAL ACCESSORIES	
further accessories on page 148	0332 Pouch Type H	0332 Pouch Type H	502823 2x18650 Li-ion Rech. Battery Pack		

<sup>1-8</sup> Information on page 176



Xavier Thevenard  
XAVIER THEVENARD  
3x UTMB® WINNER



THE STORY VIDEO





# ACCESSORIES HEADLAMPS

MODEL	MH3	MH4	MH5	MH7	MH8	MH11	NEO1R	NEO3		NEO5R	NEO9R	Item no.	MSRP (€)
Powercase		•	•	•	•							502093	49.90
Powerbank Flex3						•						502126	34.90
Powerbank Flex7						•						502125	54.90
Helmet Connecting Kit Type D	•	•	•									502220	9.90
Helmet Connecting Kit Type E				•	•							502221	9.90
Helmet Connecting Kit Type F						•						502222	9.90
Helmet Connecting Kit Type G	•	•	•	•	•	•						502223	14.90
Helmet Band Fixing Clips Type A	•	•	•	•	•	•						502313	4.90
Pouch Type H							•	•		•	•	0332	12.90
USB Car Charger		•	•	•	•	•						0380	9.90
USB Adapter 2.4A		•	•	•	•	•						502271	14.90
Li-Ion Rechargeable Battery Pack 3.7V 1550 mAh				•	•							500987	17.90
14500 Li-ion Rechargeable Battery 3.7V 750 mAh	•	•	•									500985	12.90
Charging station and 14500 Li-ion Rechargeable Battery	•	•	•									500986	18.90
18650 Li-ion Rechargeable Battery						•						501001	24.90
2x 18650 Li-ion Rechargeable Battery Pack						•				•		502823	39.90
Li-ion direct USB rech. bat. 2500 mAh						•						502595	24.90
Li-ion direct USB rech. bat. 880 mAh		•										502596	17.90



# POWERCASE

Transport safely,  
charge conveniently

- Safe, secure transportation and protection for your headlamp
- Internal magnetic charging for compatible Ledlenser headlamps
- Powerbank (5,000 mAh) with USB-A connection
- Battery charging indicator

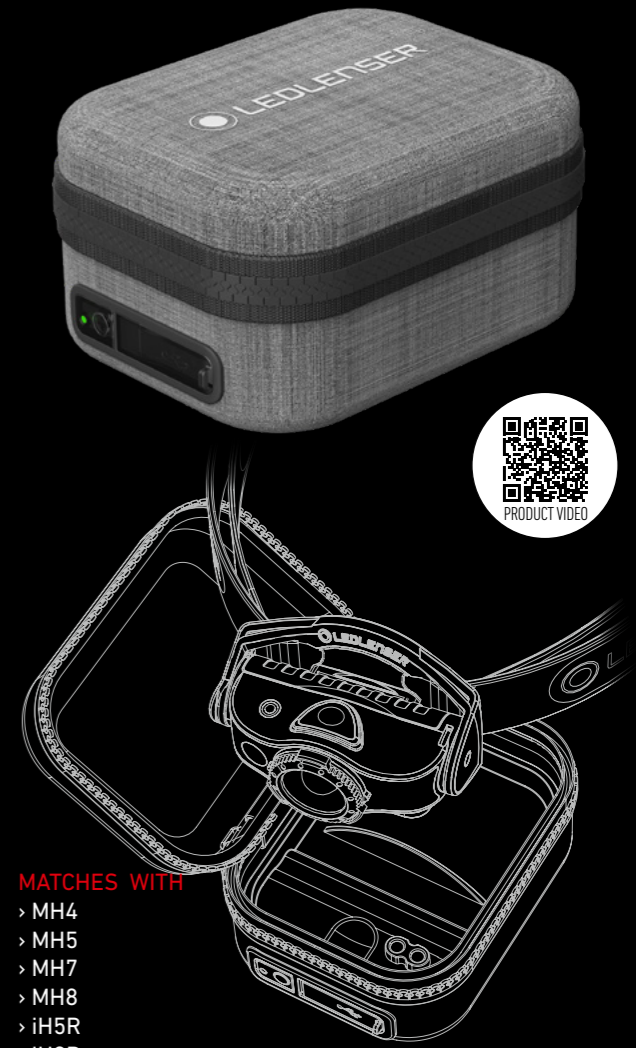

- MATCHES WITH**
- > MH4
  - > MH5
  - > MH7
  - > MH8
  - > iH5R
  - > iH9R

POWERCASE	
Weight incl. Battery (g)	219
Capacity <sup>2</sup> (Wh / mAh)	18.5 / 5000
Charging Time <sup>5</sup> (min)	180
Item no.	502093
Contents	Snap hook, Micro-USB cable
<b>Price, MSRP (€)</b>	<b>49.90</b>



# — CLIPLIGHT CU2R



TO  
SEE  
AND  
BE  
SEEN!

## TIP💡

The CU2R can be easily use as a **BACKLIGHT FOR MANY headlamps** for example e.g. NEO1R (page 132) or MH-Series (page 138)

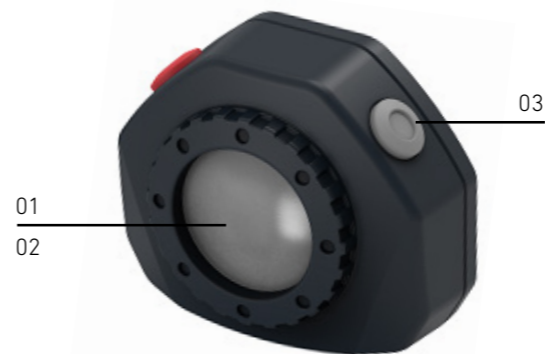

<b>LED</b>	
☰ LED-Configuration	1x Power LED (White), 2x LED (Red)
🔊 Light Functions	Power (White), Low Power (White), (+ Power (Red), Blink (White), Blink (Red))
☀️ Luminous flux <sup>1</sup> (lm)	40 / 5
➡️ Beam Distance <sup>1</sup> (m)	9 / 2
🕒 Run Time <sup>1</sup> (h)	2 / 18
<b>BATTERY AND CASE</b>	
🔋 Battery	1 x Li-ion 3.7V (internal)
🔋 Battery Capacity <sup>2</sup> (Wh / mAh)	1.036 / 280
🔌 Rechargeable	Yes
🕒 Charging Time <sup>3</sup> (min)	60
☁️ IP Level	IPX4
<b>SIZE AND WEIGHT</b>	
📏 Head Diameter (mm)	37
📏 Weight incl. Battery (g / oz)	25 / 0.9
<b>FEATURES</b>	
Additional White and Red Flashing Light, Metal Clip for Attachment as Clip Light, Transportation Lock, Wrist Strap	
<b>PACKAGING (BOX)</b>	
Item no. / GTIN	502730 / 4058205030366
Contents Box	Micro-USB Charging Cable, Wrist Strap
<b>Price (MSRP) in €</b>	<b>19.90</b>

<sup>1-8</sup> Information on page 176

CU2R is your trusted light partner that provides extra everyday safety in dim conditions and beyond – whether it's on a walk with the dog, on an evening run during rush hour or in everyday life as a rear light on clothing or backpack.

**01 – Compact, lightweight and versatile signal light with reflective wristband** to increase safety in the dark

**02 – One white LED and two extra bright red LEDs** offering two modes (power, blink)

**03 – Intuitive operation with two separate switches** for white light and red light

**04 – Elastic strap with hook-and-loop closure and metal clip** for quick and flexible attachment, e.g. on upper arm, clothing or backpack

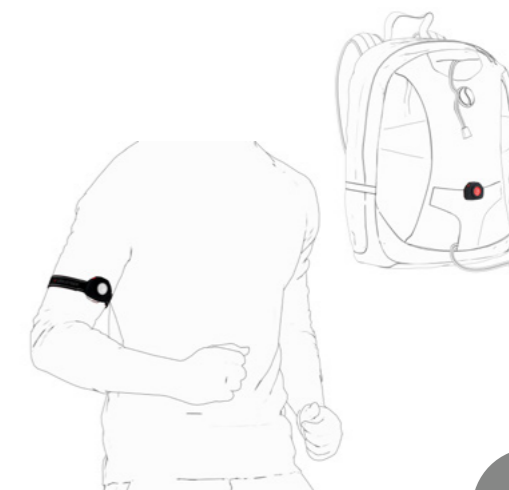



# — OUTDOOR & SPORTS LANTERNS



 LEDLENSER

OUTDOOR & SPORTS





# ML6 CONNECT WL



☀️ 750 lm<sup>1</sup> —  
🕒 180 h<sup>1</sup> —

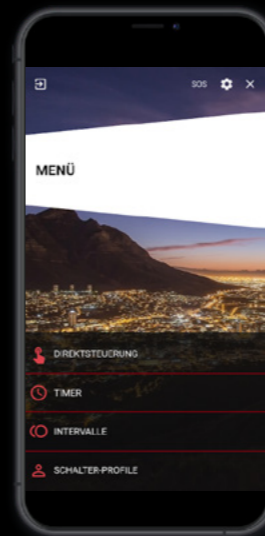

- 01 – Micro Prism Technology – patented<sup>4</sup> lens technology** for glarefree light and high energy efficiency
- 02 – Ledlenser Connect App** and wireless **Bluetooth® remote control** enable personalization and remote control of the light functions
- 03 – Infinitely dimmable** via three-way switch
- 04 – Powerbank function** with USB connection for charging electronic devices
- 05 – Red light** to maintain night vision ability
- 06 – Rubber hook** for hanging the light, integrated magnet for mounting it on metal surfaces, and a removable stand with a built-in metal hook that can be flipped out to provide more light mounting options
- 07 – Convenient and safe charging** of the batteries thanks to the **Magnetic Charge System**
- 08 – Integrated battery and charge status display**

<sup>1-8</sup> Information on page 176

## GLARE-FREE 360° ILLUMINATION WITH REMOTE CONTROL



OUTDOOR & SPORTS LANTERNS





# ML-SERIES



**ML4** **ML4 Warm Light**

LED		
LED-Configuration	9x Power LED	9x Power LED
Light Functions	Boost / Power / Mid Power / Low Power (+ Blink)	Boost / Power / Mid Power / Low Power (+ Blink)
Luminous Flux <sup>1</sup> (lm)	300 / 150 / 50 / 5	300 / 150 / 50 / 5
Beam Distance <sup>1</sup> (m)	-	-
Run Time <sup>1</sup> (h)	- / 2.5 / 8 / 45	- / 2.2 / 7 / 40
BATTERY AND CASE		
Battery	1x 14500 Li-ion Battery 3.7V	1x 14500 Li-ion Battery 3.7V
Battery Capacity <sup>2</sup> (Wh / mAh)	2.77 / 750	2.77 / 750
Rechargeable	Yes	Yes
Charging Time <sup>5</sup> (min)	150	150
IP Level	IP66	IP66
SIZE AND WEIGHT		
Diameter (mm)	34.5	34.5
Länge (mm)	97	97
Weight incl. Battery (g / oz)	71 / 2.5	71 / 2.5
TECHNOLOGY		
Smart Light Technology	●	●
Micro Prism Technology	●	●
Temperature Control	●	●
Powerbank-Funktion		
Magnetic Charge System	●	●
Dual Power Source	●	●
More Features	Low Battery Warning, Charge Indicator, Battery Indicator, Transportation Lock, Red Light	Low Battery Warning, Charge Indicator, Battery Indicator, Transportation Lock, Red Light
PACKAGING		
Item no. Window Box / GTIN	502053 / 4058205017886	502231 / 4058205022125
Contents Box	1 Set of Batteries, Magnetic Charging Cable	1 Set of Batteries, Magnetic Charging Cable
Price (MSRP) in €	<b>39.90</b>	<b>39.90</b>
OPTIONAL ACCESSORIES		
	502271 USB Adapter 2.4A	502271 USB Adapter 2.4A
further accessories on page 158	500985 14500 Li-Ion rechargeable bat.	500985 14500 Li-Ion rechargeable bat.



**ML6** **ML6 Warm Light** **ML6 Connect WL**

LED			
LED-Configuration	18x Power LED	18x Power LED	18x Power LED
Light Functions	Boost / Power / Low Power (+ Blink, Pulse, S.O.S., Strobe)	Boost / Power / Low Power (+ Blink, Pulse, S.O.S., Strobe)	Boost / Power / Mid Power / Low Power (+ Blink, Pulse, Position, Strobe, S.O.S., Alpine emergency signal)
Luminous Flux <sup>1</sup> (lm)	750 / 550 / 5	750 / 550 / 5	750 / 550 / 100 / 5
Beam Distance <sup>1</sup> (m)	-	-	-
Run Time <sup>1</sup> (h)	- / 4 / 240	- / 3.5 / 200	- / 3.5 / 12 / 180
BATTERY AND CASE			
Battery	1x 18650 Li-ion Battery 3.6V	1x 18650 Li-ion Battery 3.6V	1x 18650 Li-ion Battery 3.6V
Battery Capacity <sup>2</sup> (Wh / mAh)	11.52 / 3200	11.52 / 3200	11.52 / 3200
Rechargeable	Yes	Yes	Yes
Charging Time <sup>5</sup> (min)	300	300	300
IP Level	IP66	IP66	IP66
SIZE AND WEIGHT			
Diameter (mm)	42	42	45
Länge (mm)	178	178	178
Weight incl. Battery (g / oz)	280 / 9.9	280 / 9.9	260 / 9.2
TECHNOLOGY			
Smart Light Technology	●	●	●
Micro Prism Technology	●	●	●
Temperature Control	●	●	●
Powerbank-Funktion	●	●	●
Magnetic Charge System			●
Dual Power Source			●
More Features	Low Battery Warning, Charge Indicator, Battery Indicator, Dimmable, Transportation Lock, Red Light, Memory Mode	Low Battery Warning, Charge Indicator, Battery Indicator, Dimmable, Transportation Lock, Red Light, Memory Mode	Low Battery Warning, Charge Indicator, Battery Indicator, Dimmable, Transportation Lock, Red Light, Bluetooth®, Memory Mode, Emergency Light
PACKAGING			
Item no. Window Box / GTIN	500929 / 4058205011259	502084 / 4058205017916	502201 / 4058205021203
Contents Box	1 Set of Batterie, Stand, Transport Bag, Micro-USB Cable	1 Set of Batterie, Stand, Transport Bag, Micro-USB Cable	1 Set of Batterie, Stand, Transport Bag, Magnetic Charging Cable
Price (MSRP) in €	<b>89.90</b>	<b>89.90</b>	<b>99.90</b>
OPTIONAL ACCESSORIES			
	502126 Flex3 Powerbank	502126 Flex3 Powerbank	502126 Flex3 Powerbank





# ACCESSORIES

## LANTERNS

MODEL	ML4	ML4 Warm Light	Item no.	MSRP (€)
14500 Li-ion rechargeable battery 750 mAh	●	●	500985	12.90
Charging station and 14500 li-ion rechargeable battery	●	●	500986	18.90
USB Car Charger	●	●	0380	9.90
USB Adapter 2.4A	●	●	502271	14.90
Li-ion direct USB rech. bat. 880 mAh	●	●	502596	17.90

MODEL	ML6	ML6 Warm Light	ML6 Connect WL	Item no.	MSRP (€)
18650 Li-ion Rechargeable Battery 3.6V 3000 mAh	●	●	●	501001	24.90
USB Car Charger	●	●	●	0380	9.90
Flex3 Powerbank	●	●	●	502126	34.90
Flex7 Powerbank	●	●	●	502125	54.90
USB Adapter 2.4A	●	●	●	502271	14.90
Magnetic Charging Cable Type A			●	502265	6.90
Wireless Remote Control Type A			●	502311	34.90
Li-ion direct USB rech. bat. 2500 mAh	●	●	●	502595	24.90



Item no. 502126  
**Powerbank Flex3**  
 More information on page 152  
**€34.90 (MSRP)**



Item no. 502125  
**Powerbank Flex7**  
 More information on page 152  
**€54.90 (MSRP)**

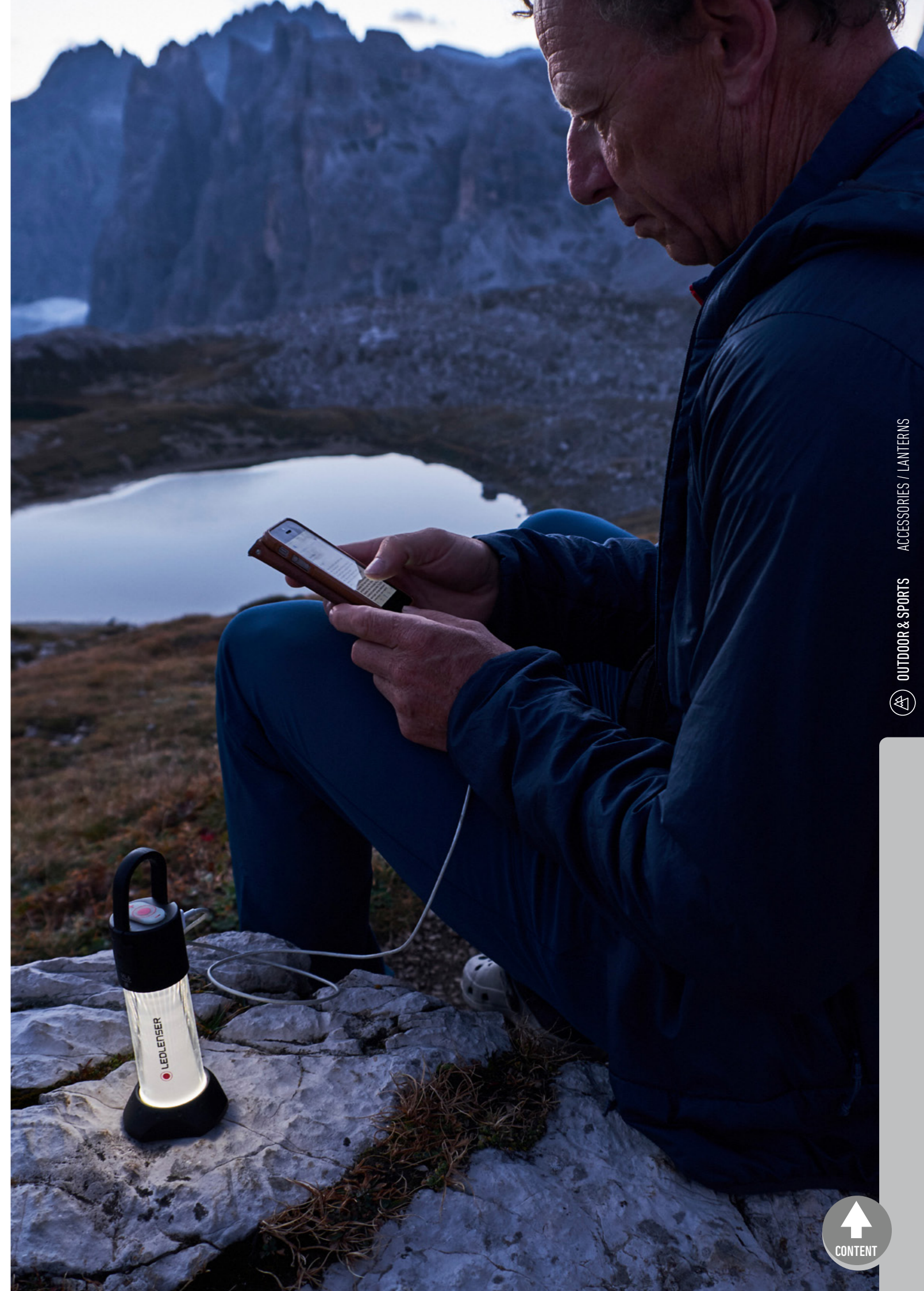



# — PORTABLE ENERGY FLEX-SERIES



 LEDLENSER



# FLEX-SERIES: THE FUTURE OF PORTABLE ENERGY

**TIP**   
The lamp adapters also fit the Flex products and therefore also to the **LEDLENSER CONNECTING SYSTEM** (page 16)  
Lamp Adapter Type D  
Item no. 502251



## FOR 21700 BATTERIES

### FLEX5

### FLEX10

TECHNICAL SPECS	Powerbank+	Powerbank+
 Length (mm)	103	120
 Width (mm)	41	54
 Height (mm)	28	29
 Weight with Battery (g / oz)	126 / 4.4	235 / 8.3
 Weight without Battery (g / oz)	55 / 1.9	164 / 5.8
TECHNOLOGY		
 Battery	1x 21700 Li-ion Akku 3.7V	2x 21700 Li-ion Akku 3.7V
 Battery Capacity <sup>2</sup> (Wh / mAh)	16.65 / 4500	33.30 / 9000
 IP Level	IP65	IP65
 Rechargeable	Yes	Yes
 Charging Time <sup>5</sup> (min)	140	240
Energy Status	Battery Indicator, Charge Indicator, Low Battery Warning	Battery Indicator, Charge Indicator, Low Battery Warning
FEATURES		
	6-IN-1	6-IN-1
	<ol style="list-style-type: none"> <li>1. <b>Powerbank</b> with replaceable battery</li> <li>2. <b>IP65</b> – Water and dust protection</li> <li>3. <b>BatteryCharger</b> (Up to 30% shorter charging time – compared to charging in a P7R CORE / WORK / SIGNATURE)</li> <li>4. Safe <b>Battery Storage</b></li> <li>5. Double protection against short circuit (box and battery)</li> <li>6. <b>Battery Charge Indicator</b></li> </ol>	<ol style="list-style-type: none"> <li>1. <b>Powerbank</b> with replaceable battery</li> <li>2. <b>IP65</b> – Water and dust protection</li> <li>3. <b>Battery Charger</b> (Up to 30% shorter charging time – compared to charging in a P7R CORE / WORK / SIGNATURE)</li> <li>4. Safe <b>Battery Storage</b></li> <li>5. Double protection against short circuit (box and battery)</li> <li>6. <b>Battery Charge Indicator</b> for both batteries</li> </ol>
MATCHES		
Ledlenser Lights	H7R Signature, H7R Work, H7R Core, P7R Signature, P7R Work, P7R Core	H7R Signature, H7R Work, H7R Core, P7R Signature, P7R Work, P7R Core
PACKAGING		
Item no. Box / GTIN	502511 / 4058205026697	502127 / 4058205019286
Contents Box	1 Rechargeable Battery, USB Cable (USB-A to USB-C)	2 Rechargeable Batteries, USB Cable (USB-A to USB-C)
Price (MSRP) in €	<b>39.90</b>	<b>69.90</b>

# FLEX10

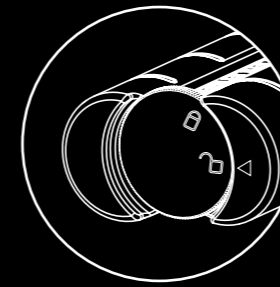

Locking wheel for maximum reliability

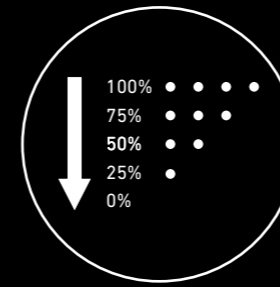

Separate charge level indicators

**UP TO 30% FASTER CHARGING**  
(Compared to charging in a Ledlenser P7R CORE / WORK / SIGNATURE)

Water and dust protection IP65/ special USB ports



## Powerbank – new portable power! Innovative 6-in-1-System

Flexible, sustainable, powerful – that distinguishes our new Flex series; the ideal addition for all outdoor activities. The rechargeable batteries of the new Ledlenser powerbanks can be removed at any time and are easy to swap out after being drained.

Therefore, the powerbanks can charge the 18650 respectively 21700 batteries used in compatible Ledlenser lights and in other electronic devices.

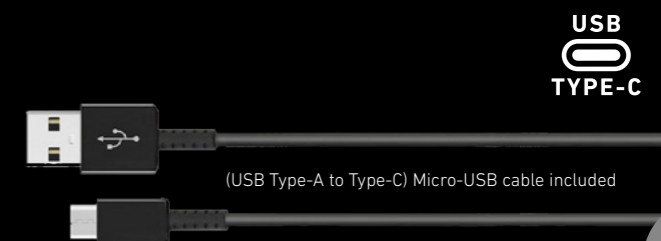
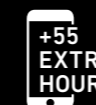

(USB Type-A to Type-C) Micro-USB cable included

PORTABLE ENERGIE





# FLEX-SERIES: EVEN MORE POWER ON THE GO



## FOR 18650 BATTERIES

### FLEX3

### FLEX7

TECHNISCHE DATEN	Powerbank+	Powerbank+
Länge (mm)	109	109
Breite (mm)	27	47
Höhe (mm)	27	27
Gewicht mit Akku (g / oz)	88 / 3.1	164 / 5.8
Gewicht ohne Akku (g / oz)	40 / 1.4	116 / 4.1
TECHNOLOGY		
Battery	1x 18650 Li-ion Battery 3.6V	2x 18650 Li-ion Batteries 3.6V
Battery Capacity <sup>2</sup> (Wh / mAh)	12.34 / 3400	24.68 / 6800
IP Level	IP65	IP65
Rechargeable	Yes	Yes
Charging Time <sup>5</sup> (min)	240	240
Energie-Statusanzeige	Battery Indicator, Charge Indicator, Low Battery Warning	Battery Indicator, Charge Indicator, Low Battery Warning
EIGENSCHAFTEN	<b>6-IN-1</b>	<b>6-IN-1</b>
	<ol style="list-style-type: none"> <li><b>Powerbank</b> with replaceable battery</li> <li><b>IP65</b> – Water and dust protection</li> <li><b>Battery Charger</b> (Up to 30% shorter charging time – compared to charging in a P6R CORE / WORK / SIGNATURE)</li> <li>Safe <b>Battery Storage</b></li> <li>Double protection against short circuit (box and battery)</li> <li><b>Battery Charge Indicator</b></li> </ol>	<ol style="list-style-type: none"> <li><b>Powerbank</b> with replaceable battery</li> <li><b>IP65</b> – Water and dust protection</li> <li><b>Battery Charger</b> (Up to 30% shorter charging time – compared to charging in a P6R CORE / WORK / SIGNATURE)</li> <li>Safe <b>Battery Storage</b></li> <li>Double protection against short circuit (box and battery)</li> <li><b>Battery Charge Indicator</b> for both batteries</li> </ol>
PASSEN ZU		
Ledlenser-Lampen	iH11R, MH11, NEO9R, ML6, ML6 Warm Light, ML6 Connect WL, P6R Signature, P6R Work, P6R Core, P6R Core QC	iH11R, MH11, NEO9R, ML6, ML6 Warm Light, ML6 Connect WL, P6R Signature, P6R Work, P6R Core, P6R Core QC
PACKAGING		
Item no. Box / GTIN	502126 / 4058205019255	502125 / 4058205019224
Contents Box	1 Rechargeable Battery, Micro-USB Cable	2 Rechargeable Batteries, Micro-USB Cable
Price (MSRP) in €	<b>34.90</b>	<b>54.90</b>

<sup>1-8</sup> Information on page 176



PORTABLE ENERGIE





# — TECHNOLOGY



 LEDLENSER



# LEDLENSER TECHNOLOGY-ABC

From innovative lenses and advanced light functions to future-oriented power supplies - we work tirelessly to improve our technology to further expand our lead. Here are some examples:



## ADVANCED FOCUS SYSTEM (AFS)

Galileo swore by the power of lenses; Newton by the power of reflectors. We have simply combined the two Technologies – only better than anyone before. The result: our patented Advanced Focus System (AFS), which allows a seamless transition from homogeneous low beam to sharply focused high beam.

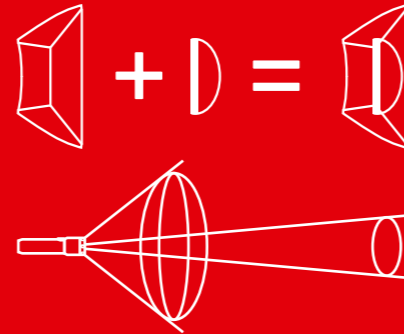

## COOLING TECHNOLOGY

Cooling Technology (CT) ensures your head stays cool even when your light is at maximum power. Our CT products reduce LED heat to the optimal level by means of the intelligent use of cooling elements. This technology is also used to cool computer chips and ensures highly efficient use of energy, increased illuminating power, and especially long-lasting LEDs.

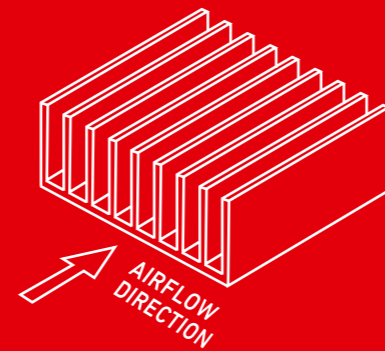

## DUAL POWER SOURCE

Our Dual Power Source allows you to use the full performance of your Ledlenser at any time – no matter what power source you have available. This technology recognizes the power source and you can therefore choose between the rechargeable Ledlenser battery or a disposable battery. Extremely practical for long trips without a power point.

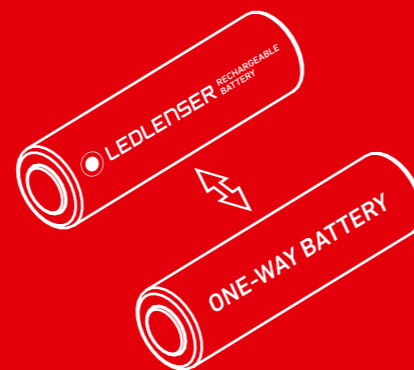

## EMERGENCY LIGHT

This feature turns your flashlight into an emergency light: If the power goes out while your Ledlenser is on the charging base, it will automatically turn on. So the light helps you find your way around, e.g. to the breaker panel.



## FLOATING CHARGE SYSTEM

Grab-and-go wireless charging. The Floating Charge System is a wall-mounted magnetic charging system, getting the light ready to go with a simple flick of the wrist. It also offers USB charging with an adapter system that can be plugged into standard outlets or car lighters.



## FLEX SEALING TECHNOLOGY

The innovative Flex Sealing Technology ensures that the electronic parts of the lamp head are completely sealed off, to protect against the penetration of water and dust. This flexible system maintains the seal, even when the Advanced Focus System is used. The focus can even be used underwater.



## FUSION BEAM

By combining different LEDs and lenses, lights with Fusion Beam have a unique, application-optimized illumination. This simultaneously enables a homogenous close-up wide flood beam and sharply focused long-distance beam. The intensity of the flood and spot beams can be individually adjusted thanks to independent controls for each light source.



## MAGNETIC CHARGE SYSTEM

With the Magnetic Charge System, the charging cable can quickly and easily be attached to the light. The connection for charging the battery is made via magnetic contacts. When the contacts approach each other, the charging cable automatically pairs with the light. The connection is automatically released under load.

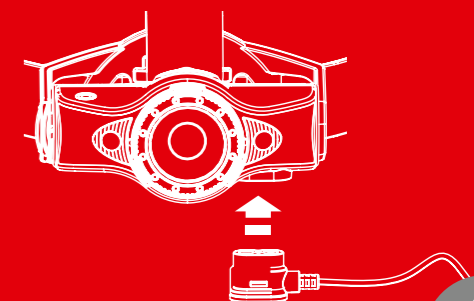





### MICRO PRISM TECHNOLOGY

Our innovative lens technology features an optical microstructure, which provides both glare-free light distribution and high efficiency at the same time. It ensures a downward beam that is up to three times stronger than conventional scattered light lenses and therefore provides optimal light distribution in the room, regardless of whether the light sits on a table or hangs from the ceiling. It creates a brighter view, whether used indoors or outdoors.



### MULTI-CORE OPTICS

Multi-Core Optics harness and direct the light emitted from extremely powerful, next-generation LEDs. The special faceted lens tames and directs the light, resulting in a homogeneous beam and aesthetic illumination.



### NATURAL LIGHT

In certain situations the perceived color of light differs. Ledlenser therefore not only supplies extremely bright, but also extremely natural (CRI) over 90. This ensures true color rendering, even in the deep red color range.

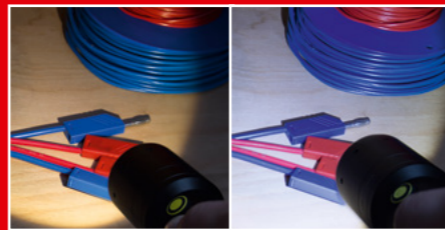

CRI 90, 4000 K

CRI 65, 6500 K



### OPTISENSE TECHNOLOGY

Whether it's dusk, dim or pitch black, Optisense Technology allows your Ledlenser to automatically adapt to the surrounding light conditions. The innovative dimmer controls luminosity based on the reflection of its own light and prevents glare.



### POWERBANK

Even in the most remote corners of the world, you'll never again have to worry about any device's battery running out. Some Ledlenser Lights have a Powerbank function so they can easily be used as charging stations to recharge any device quickly via a USB connection.

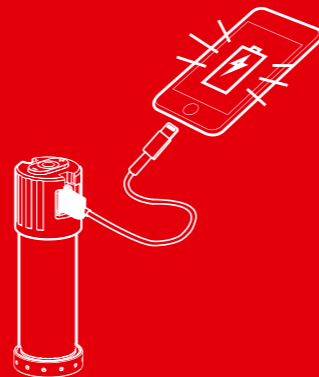

### RAPID FOCUS

When focusing or defocusing the flashlight or headlamp, the reflector lens moves in relation to the LED. To ensure this process is as quick and ergonomic as possible we developed Rapid Focus: a single-hand mechanism that allows the light beam to be adjusted as fast as lightning.

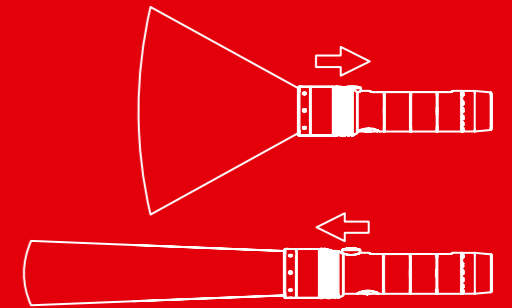

### SAFETY YTRION CELL

A Safety Ytrion Cell is significantly lighter than a nickel-metal hydride battery and charges up to five times faster than a lithium-ion battery. At the same time, it offers more than 5000 charging cycles with almost zero loss of capacity "Memory Effect".



### SMART LIGHT TECHNOLOGY (SLT)

This innovation turns a Ledlenser into your personal lighting tool: A micro-controller allows individual ranges of functions to be programmed to different touch and switch combinations. That way, you always have the perfect light mode at hand.

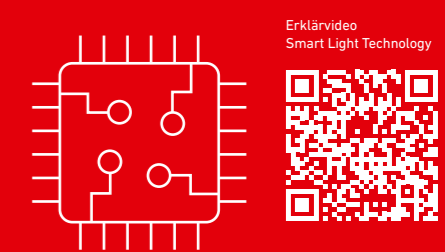

### TEMPERATURE CONTROL

Our lights stay cool, even when they work hard. Thanks to the intelligent and fully automated temperature control, a Ledlenser never gets too hot, no matter how much it is used. This protects you from burns and the LED from overheating.



### X-LENS TECHNOLOGY

This technology is an enhancement of the Advanced Focus System (AFS). It can merge virtually any number of reflector lenses and synchronizes their individual light beams into a perfect beam, resulting in a high-grade, homogeneous floodlight in unfocused mode and our most sharply focused high beam to date.





# LEDLENSER LIGHT FUNCTIONS

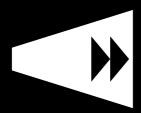

## BOOST

A temporary burst of light



## POWER

A bright light for any situation

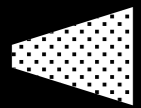

## MID POWER

Sufficient light output for extended battery life



## LOW POWER

Economical light for long battery life, glare-free reading and working



## PULSE

The light intensity keeps rising and decreasing evenly



## STROBE

Quick flashes of light with an irritating blinding effect for emergency situations



## BLINK

Automatically emits light pulses at regular intervals



## POSITION

Regular light pulses at long intervals for position marking



## S.O.S.

The light emits an SOS distress signal in morse code (3 x short, 3 x long, 3 x short)

## CONSTANT LIGHT

Constant light means the light will maintain a more consistent level of brightness. The light will not gradually dim as the battery power decreases. As the battery power is diminished, the light emits a periodic warning signal. Before shutting down completely, the light provides about one hour of residual light in the backup mode.

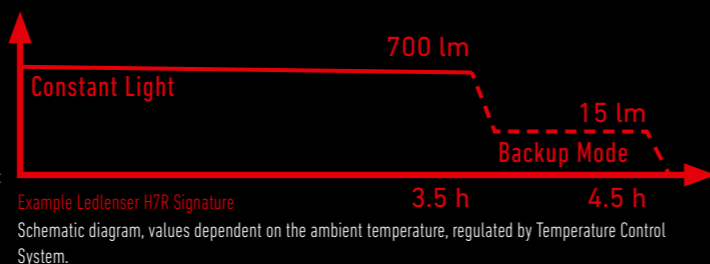

# IP RATINGS

IP ratings define the protection of the products against the penetration of foreign particles (mainly dust, dirt) and water. Basically, the following applies: The higher the value, the higher the protection rating. However, there is one caveat: Up to the protection rating IPX6, the lower ratings are automatically included when the protection against the ingress of water is indicated. However, both higher ratings (IPX7 and IPX8) refer to another type of water ingress (submersion under water). That is why the products of our iL and EX series for example comply with the protection ratings IP66 and IP68. That means they are protected against powerful water jets as well as continuous submersion.

We assess the protection ratings of our products in accordance with the internationally recognized DIN EN 60529 standard.

## IP TYPE ACCORDING TO EN 60529

**IP56**

1. Part: Protection against the ingress of foreign particles
2. Part: Protection against the ingress of water

### 1. PART

PROTECTION AGAINST THE INGRESS OF FOREIGN PARTICLES

- X Not tested
- 0 No protection against the ingress of foreign particles
- 1 Protection against ingress of solid foreign particles with a diameter > 50mm
- 2 Protection against ingress of solid foreign particles with a diameter > 12,5mm
- 3 Protection against ingress of solid foreign particles with a diameter > 2,5mm
- 4 Protection against ingress of solid foreign particles with a diameter > 1mm
- 5 Protection against harmful dust deposits at the inside
- 6 Protection against ingress of dust (dust-tight)

### 2. PART

PROTECTION AGAINST THE INGRESS OF WATER

- X Not tested
- 0 No protection against the ingress of water
- 1 Protection against vertically dripping water
- 2 Protection against dripping water falling at an angle (with 15° incline)
- 3 Protection against splashing water (inclined up to 60°)
- 4 Protection against splashing water (from all directions)
- 5 Protection against water jets (from all directions)
- 6 Protection against strong water jets
- 7 Protection against submersion in water up to 1 meter deep for up to 30 minutes
- 8 Protection against submersion in water up to a specified depth.





# LEDLENSER RECOMMENDED APPLICATION

Our product line provides you with the perfect light for a wide range of purposes. Whether for professional and industrial use, everyday life or use in sports and leisure - we supply customized lighting. Our recommendations - symbolized by icons - are to be understood as a general guide, but not as a restriction to these areas of use.



## HOME & LIFE



HOME



DIY



DOG WALK



TRAVEL



PHOTOGRAPHY



## WORK & PROFESSIONAL



CRAFT



INDUSTRY



POLICE



SECURITY



FIREFIGHTER



MEDICAL



SEARCH & RESCUE



## OUTDOOR & SPORTS



HIKING



CAMPING & CARAVANING



RUNNING



FISHING



HUNTING



MOUNTAINEERING



BOATING



ACTION



GEOCACHING



# — ABOUT US



Ledlenser headquarter in Solingen





## IT TAKES EIGHT MINUTES FOR THE LIGHT OF THE SUN TO REACH THE EARTH – OURS ONLY TAKES THE PUSH OF A BUTTON

The sun and Ledlenser have something in common: We create light for the whole world! We are devoted to this task with all our energy and capability. The quality products made by Ledlenser prolong daylight and therefore, enable being active when dusk sets in or even during total darkness. They bring light into the darkest corners and in doing so, enable precise and professional work at any time.

## WAS UNS AUSZEICHNET

- › One of the global market leaders in portable lights. That includes: Flashlights, headlamps, work lights, floodlights, lanterns, EX-protected lights
- › „German Engineering & Design“: In-house development, production and quality assurance
- › Inventor of the trendsetting and patented<sup>3</sup> Advanced Focus System
- › 7-year warranty<sup>4</sup> for most products in connection with online registration
- › More than 100 industrial property rights as well as more than 200 awards and prizes for our products
- › More than 650 employees worldwide
- › Company-owned offices in Germany, China, USA, Yespan, Denmark, United Kingdom, Italy and Switzerland
- › Worldwide collaboration with more than 30 master distributors

## OUR PRODUCTION PLANT IN CHINA

To ensure that our bright ideas see the light of day, we clearly divided up our tasks: “Engineered in Germany, produced in China”. Our production expertise is concentrated at our location in Yangjiang, Guangdong. Every product is manufactured and tested here; from prototype to mass production.

The checklist for quality control includes 24 tests: Endurance, extreme temperatures, water, salt, impact, pressure and more - inspected and tested until the products have overcome all obstacles and meet our quality standards. Furthermore, it is important to us to take responsibility for our employees in China. We do this for example by building company housing and through our involvement in social and intercultural projects.



## MORE THAN 20 YEARS OF EXPERTISE IN LIGHTING SOLUTIONS

When the two brothers Harald and Rainer Opolka from Solingen started out, they really didn't have much more than a garage, an old Atari computer, a set of tools, a drawing pad and around 1000 Deutschmarks of seed capital. Today, the former garage company of both the Ledlenser founders is an internationally operating company and one of the global market leaders in portable lights. The German Ledlenser brand conquered the flashlight market in the year 2000. The approach of equipping a flashlight with an LED instead of a bulb as a light source was absolutely visionary at that point in time. Millions of the “V8 Photon Pump” were sold worldwide and it constituted a new era of portable light – the “P7” achieved the same thing several years later.

To meet our objective as an LED pioneer, we are still using this technological advantage today in the development of new products – particularly in times during which LED lighting has become the norm in so many places and genuine quality is becoming harder and harder to recognize. At the same time, our premise “German Engineering & Design” has guided us from day one and justifies our unique commitment to quality. Ledlenser products give users worldwide the freedom of doing their jobs to the best of their ability or pursuing their passion with devotion – with the best possible light on their side.

<sup>1-8</sup> Information on page 176



# LEDLENSER MILESTONES

2000

LED key ring flashlight **Photonpump V8** is put on the market and sold a million times over



2005

Development of the patented<sup>3</sup> **Advanced Focus System**



2011



Ledlenser is included in the **Guinness World Records** with the construction of the world's largest flashlight

2018

With the **new EX products**, Ledlenser launches its first focusable EX-protected flashlights



ZONE 0/20

2020



Ledlenser expands into the "portable energy" sector - **Powerbanks and battery boxes** are the first products in this category



**Light revolution** – launch of the new P-series and H-series in the three versions CORE-WORK-SIGNATURE



1993

Company founded by **Harald and Rainer Opolka**



Opening of the company's own **production facility** in Yangjiang, China



2008

Launch of the **legendary P7** – still a bestseller today



Bluetooth®

2019

**Floodlights and Worklights** expand the portfolio for trade and industry

2021

**KidsLights** the first Ledlenser collection created specifically for children



<sup>1,2</sup> Information on page 176





# LEDLENSER QUALITY GUARANTEED

7  
YEAR  
WARRANTY<sup>4</sup>



**GERMAN ENGINEERING  
& DESIGN**



## QUALITY

"German Engineering & Design" - this statement stands for the highest development and production standards in regard to technology, design, materials and workmanship. We hold more than 100 industrial property rights. These include patents, utility models and designs. We are proud of having received various design awards for our products.

## WARRANTY

Since we are confident in the quality of our lights, we grant a seven-year warranty on nearly all products in connection with online registration. All original Ledlenser products covered by our warranty include a product registration card. To register, simply scan the QR code with a smartphone or enter the indicated URL on your laptop or PC.

## ISO CERTIFICATION

We meet the requirements of the ISO 9001, ISO 14001 and ISO 50001 standards and are certified by TÜV Rheinland.

### Quality management: DIN EN ISO 9001:2015

Our systematic quality management ensures a consistently high quality of our products and services. Clearly defined and comprehensible processes enable us to meet our customers' expectations consistently and professionally. We also meet the standard requirements at our Chinese location.

### Environmental management: DIN EN ISO 14001:2015

Our company has defined an internal environmental policy and precise environmental objectives. Here, the focus is on the establishment and realization of an environmental management system, to ensure continuous improvements – e.g. in regard to CO<sub>2</sub> emissions, the use of resources and other environmental factors.

### Energy management: DIN EN ISO 50001:2018

We operate energy management geared towards sustainability. This includes measures to reduce the consumption of energy such as electricity, gas and fuel as well as specific risk prevention.

<sup>1,2</sup> Information on page 176



# NOTES

The information pertaining to package contents, appearance, performance, dimensions and weight corresponds to the information available at the time of publication. In the interest of product development, we reserve the right to change package contents, appearance, design and color without prior notice. Product images may vary from the actual products and may show optional accessories which can be purchased separately. Errors and misprints excepted.

1) Measurements according to ANSI FL1 on the respective setting. If no setting is explicitly indicated, the values refer to luminous flux (Lumen/lm) and beam distance (meters/m) on the highest setting and to the run time (hours/h) on the lowest setting. If the light is equipped with color LED(s), the measurements indicated apply to white light or white LED. A boost function (if applicable) can be used several times, but only for short periods of time. If the light has different energy modes, measurement is based on "energy saving mode."

2) Calculated capacity value in watt-hours (Wh) or milliampere hours (mAh). This applies to the delivery state of the battery/ies inside the respective item, or for lights with rechargeable battery/ies, to the rechargeable battery/ies inside the product when fully charged.

3) EP Patent 1880139; US Patent 7,461,960

4) Two year warranty from the date of purchase, or seven years with online registration through our website. The warranty applies worldwide; legal warranty rights also apply. It covers defects in material and manufacture. Battery packs are guaranteed to work correctly for 24 months. This warranty does not cover products in the "Solidline" series, the LiteWallet®, the Powercase, the Batterybox7, the Kidled-Series also the Ledlenser K-Serie (except K3), as well as defective batteries, holsters, pouches, remote switches, color filters, imprints and surface coatings. The warrantor is Ledlenser GmbH & Co. KG, Kronenstr. 5-7, 42699 Solingen, Germany. For more information visit [ledlenser.com/warranty](http://ledlenser.com/warranty)

5) The average charging time of the batteries in the delivery state in minutes may vary depending on the power supply unit used.

6) Additional talk time using the example of an iPhone X when charging with the fully charged batteries contained in the content of the article in question.

7) EP-Patent 3376097

8) The Bluetooth® word mark and logos are registered trademarks owned by Bluetooth SIG, Inc. and any use of these by Ledlenser GmbH & Co. KG is under license

You can find our terms and conditions at [www.ledlenser.com](http://www.ledlenser.com)

Ledlenser GmbH & Co. KG  
Kronenstraße 5-7, 42699 Germany, Deutschland  
USt-IdNr.: DE815242425, Amtsgericht Wuppertal, HRA 23078  
Personally liable partner:  
Ledlenser Beteiligungs GmbH  
Headquarters: Solingen, Deutschland  
Amtsgericht Wuppertal, HRB 24774  
Executive Director: Michael Reuter, Kai Milewski

# LEDLENSER WE'RE LOOKING FORWARD TO PARTNERING WITH YOU

We are always looking for ways to improve how we can support you and your customers. We greatly appreciate any feedback you have on how we can build the Ledlenser brand together.

## CONTACT MARKETING

Get answers to marketing questions and approval of marketing materials at: [marketing@ledlenser.com](mailto:marketing@ledlenser.com)

## CONTACT TECHNICAL SUPPORT

For uncomplicated and fast processing, please contact our Consumer Care Team for all services, product, warranty and goodwill questions.

Customers from Germany can reach us by e-mail: [support@ledlenser.com](mailto:support@ledlenser.com)

Customers from Belgium, the Netherlands and Luxembourg can reach us by e-mail: [service.bnl@ledlenser.com](mailto:service.bnl@ledlenser.com)

Customers from Austria can reach us by e-mail: [support@ledlenser.at](mailto:support@ledlenser.at)





